



# ONE SMART BOX

Gloomhaven® Organizer

GNOR01

Compatible with Gloomhaven®

Assembly Guide



Created for:

- Gloomhaven
- Gloomhaven: Forgotten Circles



Scan QR-code and watch component layout video on Smonex youtube channel.

**NOT A CHILDREN TOY  
AGE 14+**

Gloomhaven® is a registered trademark of Cephalofair Games. Any mention of Gloomhaven® is for reference purposes only. ALL RIGHTS RESERVED by their respective trademark holders. No challenge to any intellectual property rights is intended or implied by representations of compatibility and no endorsements of any of our products by any other company is implied or represented.

# Gloomhaven® Organizer

GNOR01

Compatible with Gloomhaven®  
Assembly Guide

## Tips and tricks

- To assemble each tray you need a wood glue for extra strength. (We recommend Titebond 2 Wood Glue or Beacon 527)
- Please make sure you assembled each tray correctly before gluing it together.
- Use stationery knife to cut the bits that connect details to the frame.
- Remove the details from the frame with a rotational motion along the axis formed by the bits you just cut.
- Use stationery knife to remove all the remaining connection bits.
- You may fix the box with rubber bands after gluing it. This will save you time and simplify the assembly.
- Use a hairdryer for easier removal of the protective covering from acrylic details. Just heat the acrylic surface a little to remove the covering much easier!
- Leave your finished insert overnight to dry completely.

## Assembly Supplies



Wood glue



Stationery knife



Hammer



Cotton swab



Rubber bands



Hairdryer

If something is damaged or broken, please do not return the whole set.  
Contact us directly on email [info@smonex.com](mailto:info@smonex.com) or our website [smonex.com](http://smonex.com).  
Any questions or issues with the Smonex products, we'll do our best to help you.  
We want our customers to be completely satisfied.

**IMPORTANT:** Assemble each tray one by one. Please **DO NOT** take out all the parts from the sheets and mix them. Even though some parts look similar, they are not interchangeable.

This is a non-licensed product. ALL RIGHTS RESERVED by their respective trademark holders. No challenge to any intellectual property rights is intended or implied by representations of compatibility and no endorsements of any of our products by any other company is implied or represented.



# Gloomhaven® Organizer

GNOR01

Compatible with Gloomhaven®  
Assembly Guide

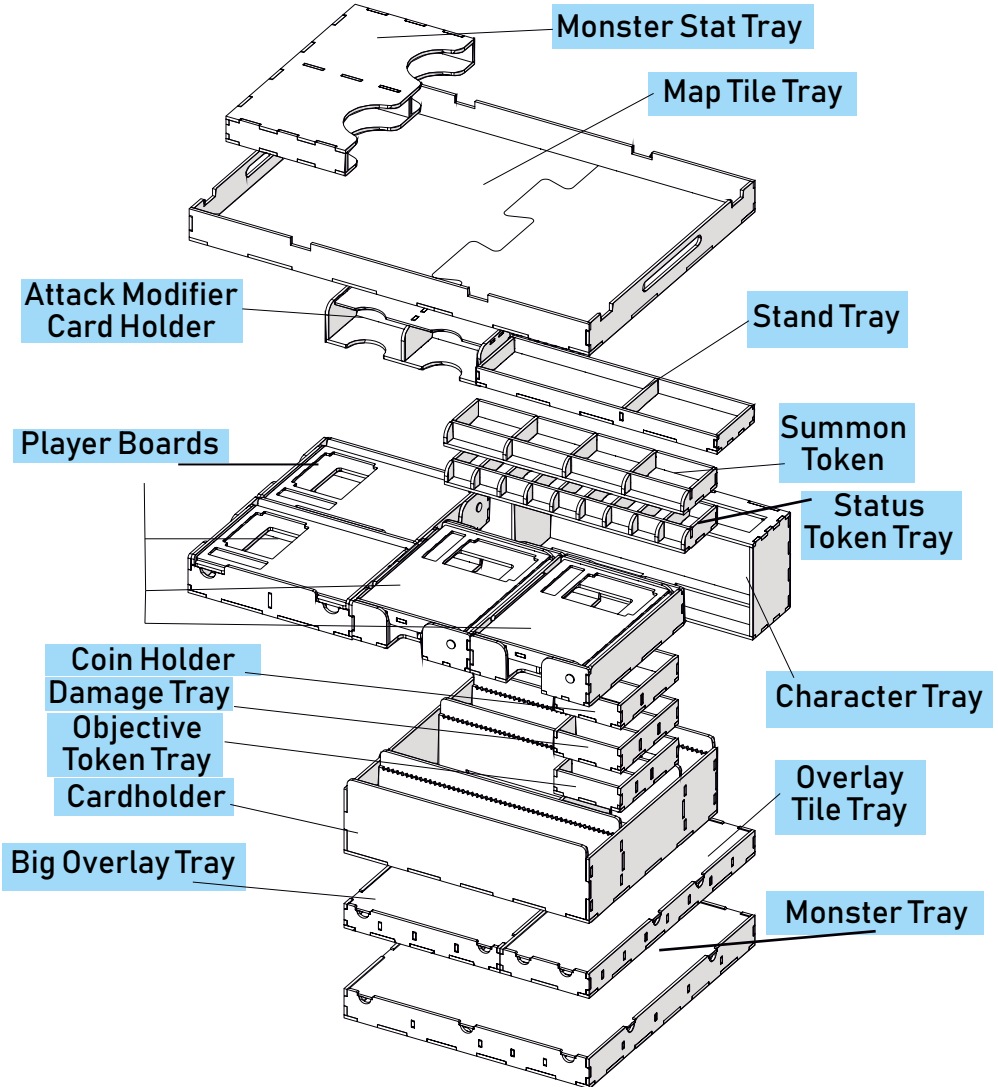

This is a non-licensed product. ALL RIGHTS RESERVED by their respective trademark holders. No challenge to any intellectual property rights is intended or implied by representations of compatibility and no endorsements of any of our products by any other company is implied or represented.

# Gloomhaven® Organizer

GNOR01



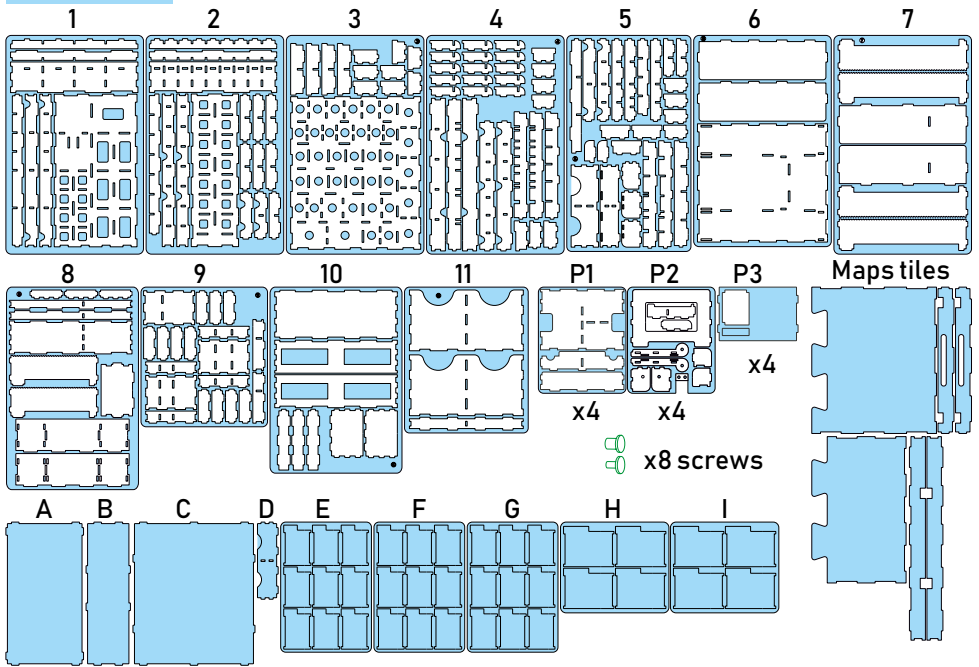

## Compatible with Gloomhaven® Assembly Guide

- Brief assembly instructions:**
1. Unpack and arrange the sheets in order.
  2. Compare details on the sheets with details in the pictures of the guide.
  3. Study the pictures of unassembled product.
  4. Start your assembly, taking the necessary parts out of the sheets in a certain order.

**Components:**



**Legend:**

-  highlighted details to be extruded
-  details not used in this assembly
-  details to be connected without glue
-  details to be glued
-  details to be screwed

**Components:**

- 19 sheets extrusion molds
- 5 acrylic sheets extrusion molds (E,F,G,H,I)
- 8 acrylic lids (A,B,C,D, 4xP3)
- 6 large parts (for Map tile tray)
- 8 screws
- Assembly guide
- 1 sandpaper for stripping parts

This is a non-licensed product. ALL RIGHTS RESERVED by their respective trademark holders. No challenge to any intellectual property rights is intended or implied by representations of compatibility and no endorsements of any of our products by any other company is implied or represented.



# Gloomhaven® Organizer

GNOR01

Compatible with Gloomhaven®

Assembly Guide

## Big Overlay Tile Tray

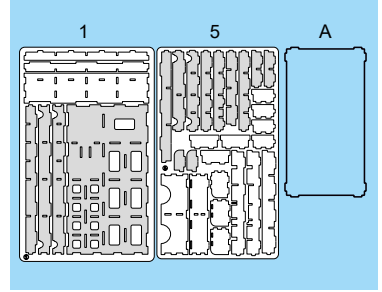
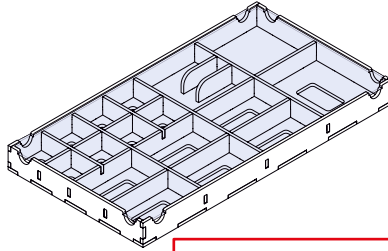

Please DO NOT take all the parts out of the sheets at once in order not to mix them up. It will help you not get lost in a lot of components.

Intended for 2-sided overlay tiles storage (terrain, tables, walls).

Step 1

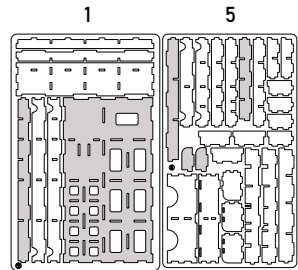
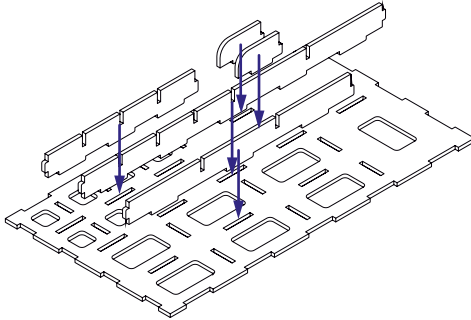

Step 2

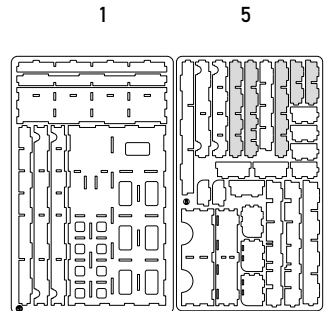
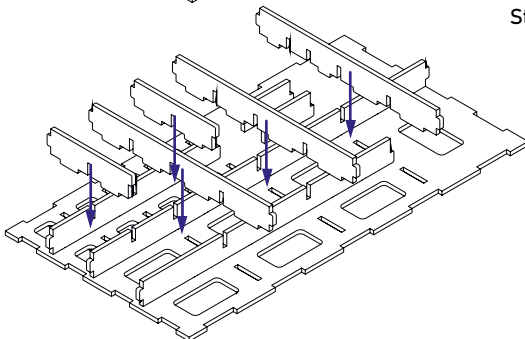

This is a non-licensed product. ALL RIGHTS RESERVED by their respective trademark holders. No challenge to any intellectual property rights is intended or implied by representations of compatibility and no endorsements of any of our products by any other company is implied or represented.

smonex  
Gloomhaven® Organizer  
GNOR01  
Compatible with Gloomhaven®  
Assembly Guide

Big Overlay Tile Tray

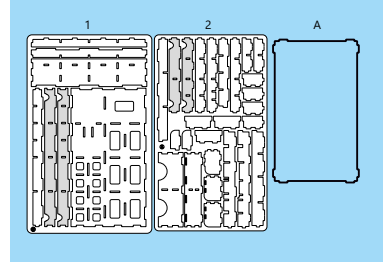

Step 3

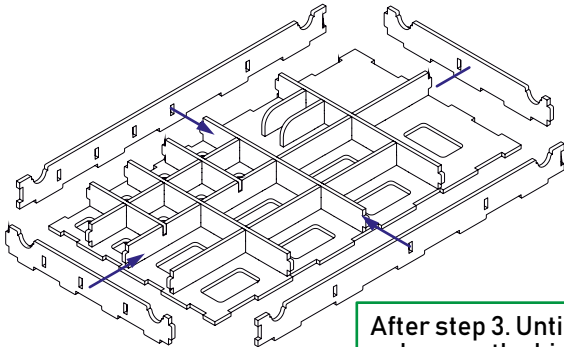

After step 3. Until the glue has completely dried, make sure the Lid A fits the tray and can be easily removed. Put it back in its place on the tray. Only then remove the protective covering.

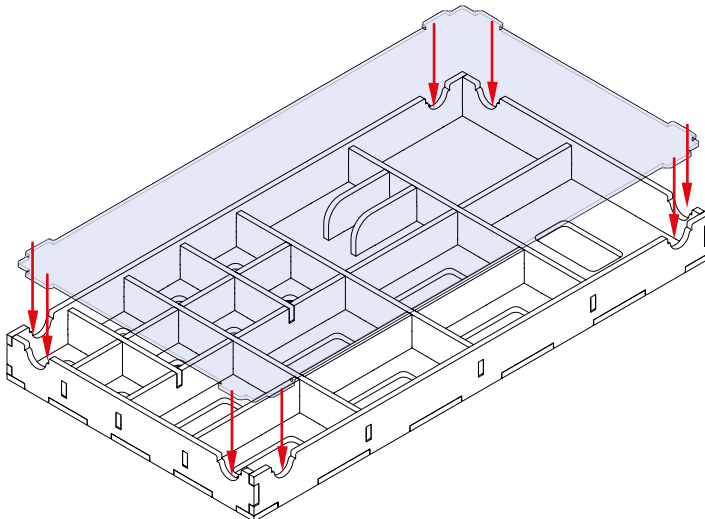

Step 4

This is a non-licensed product. ALL RIGHTS RESERVED by their respective trademark holders. No challenge to any intellectual property rights is intended or implied by representations of compatibility and no endorsements of any of our products by any other company is implied or represented.

# Gloomhaven® Organizer

GNOR01

Compatible with Gloomhaven®  
Assembly Guide

## Overlay tile tray

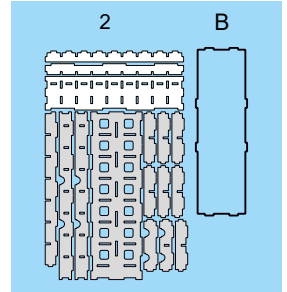
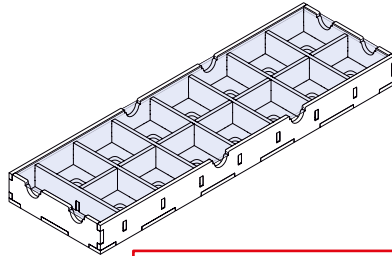

Intended for 2-sided overlay tile storage (obstacles, traps, treasure).

Please DO NOT take all the parts out of the sheets at once in order not to mix them up. It will help you not get lost in a lot of components.

Step 1

Step 2

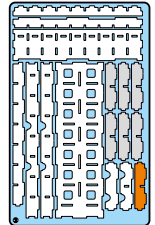
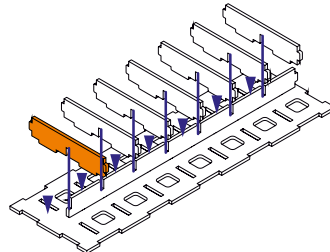
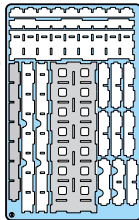
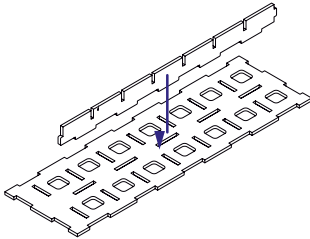

Please, pay attention, orange detail is different from the others.

Step 3

Step 4

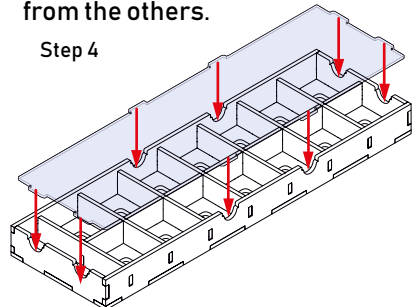
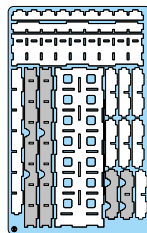
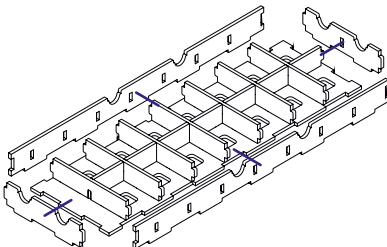

Until the glue has completely dried, make sure the Lid B fits the tray and can be easily removed. Put it back in its place on the tray. Only then remove the protective covering.

This is a non-licensed product. ALL RIGHTS RESERVED by their respective trademark holders. No challenge to any intellectual property rights is intended or implied by representations of compatibility and no endorsements of any of our products by any other company is implied or represented.



# Gloomhaven® Organizer

GNOR01

Compatible with Gloomhaven®

## Assembly Guide

### Monster tray

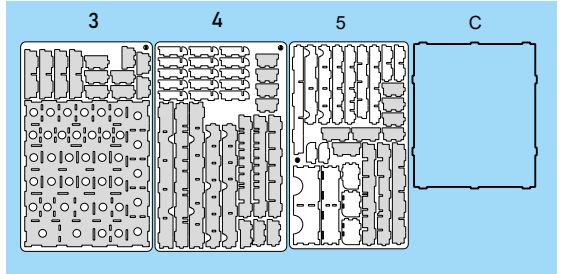
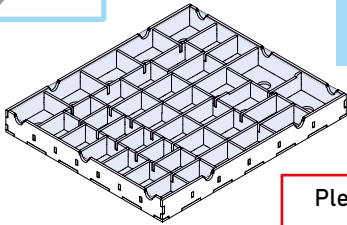
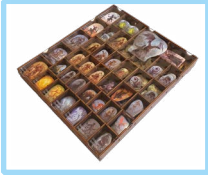

Please DO NOT take all the parts out of the sheets at once in order not to mix them up. It will help you not get lost in a lot of components.

Intended for monster storage.

### Step 1

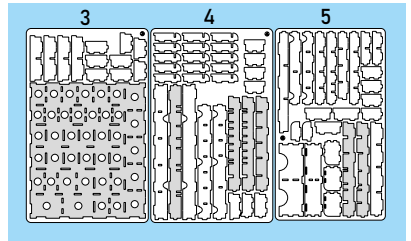
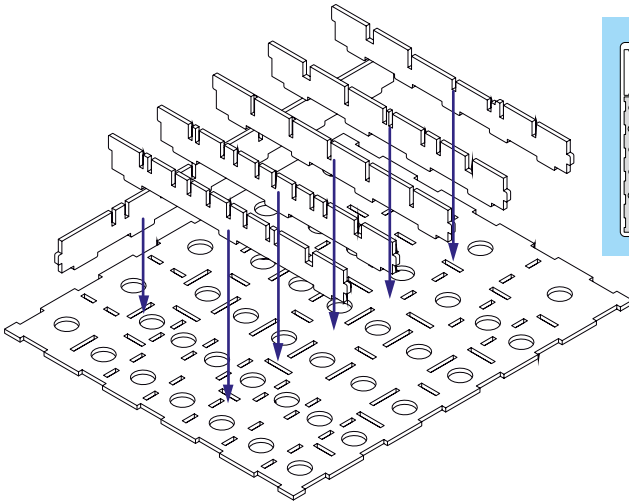

This is a non-licensed product. ALL RIGHTS RESERVED by their respective trademark holders. No challenge to any intellectual property rights is intended or implied by representations of compatibility and no endorsements of any of our products by any other company is implied or represented.





# Gloomhaven® Organizer

GNOR01

Compatible with Gloomhaven®  
Assembly Guide

## Monster tray

Step 2

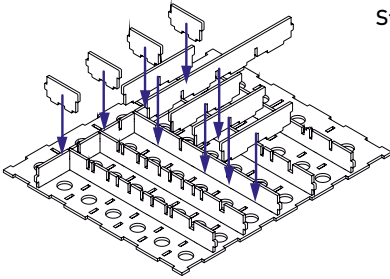

Step 3

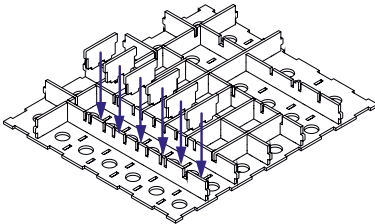

Step 4

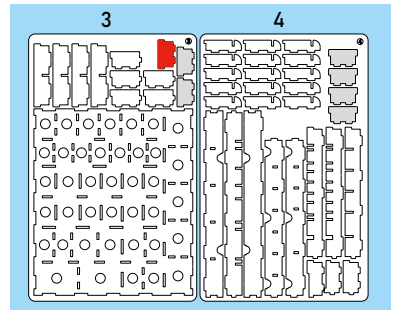
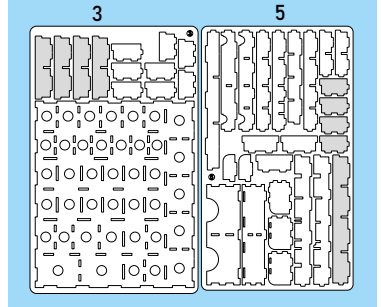
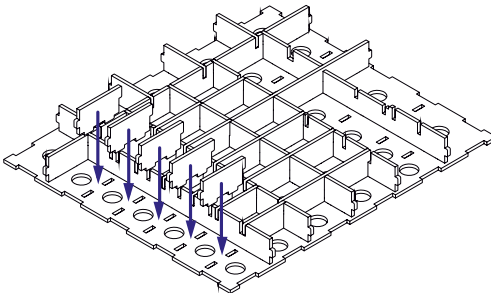

Red detail is a spare part.

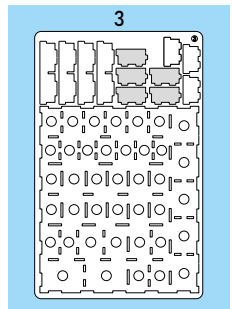



# Gloomhaven® Organizer

GNOR01

Compatible with Gloomhaven®

Assembly Guide

## Monster tray

Step 5

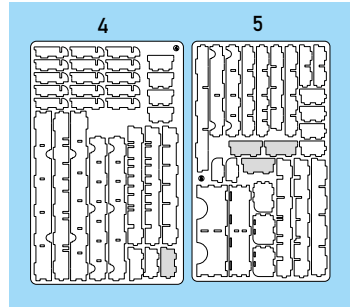
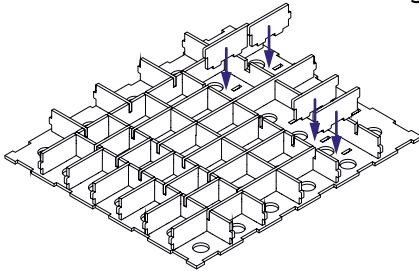

Step 6

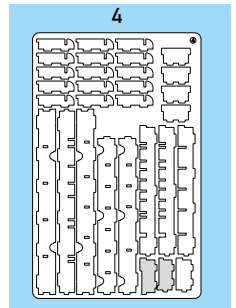
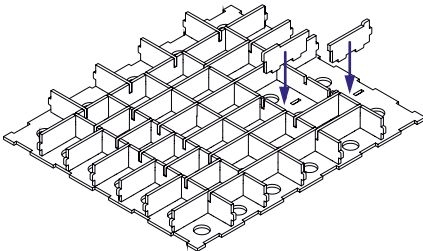

Step 7

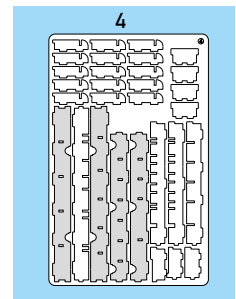
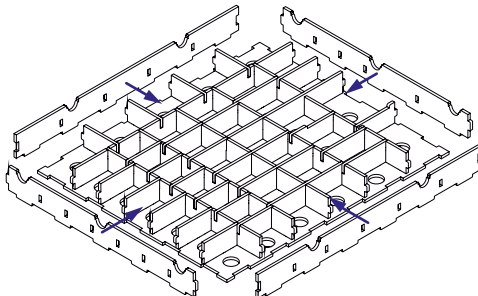

This is a non-licensed product. ALL RIGHTS RESERVED by their respective trademark holders. No challenge to any intellectual property rights is intended or implied by representations of compatibility and no endorsements of any of our products by any other company is implied or represented.



# Gloomhaven® Organizer

GNOR01

Compatible with Gloomhaven®

Assembly Guide

Monster tray

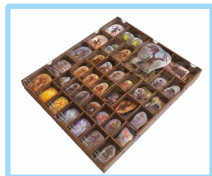

Step 8

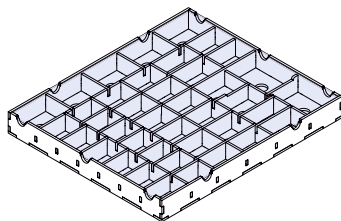

Until the glue has completely dried, make sure the Lid C fits the tray and can be easily removed. Put it back in its place on the tray. Only then remove the protective covering.

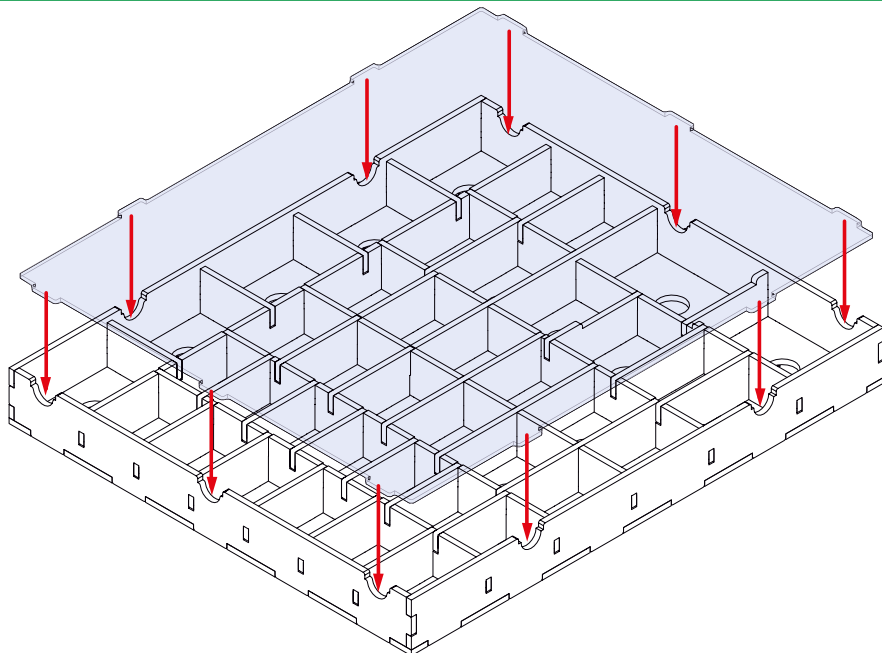

This is a non-licensed product. ALL RIGHTS RESERVED by their respective trademark holders. No challenge to any intellectual property rights is intended or implied by representations of compatibility and no endorsements of any of our products by any other company is implied or represented.

# Gloomhaven® Organizer

GNOR01

Compatible with Gloomhaven®  
Assembly Guide

## Summon token tray

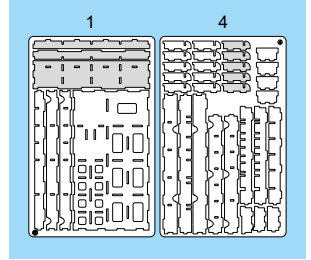
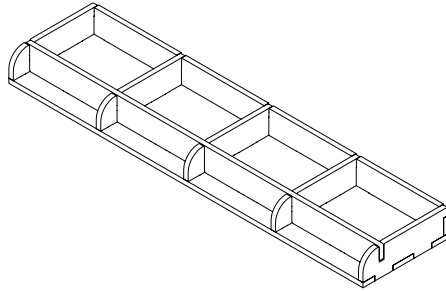

Intended for Summon Token storage.

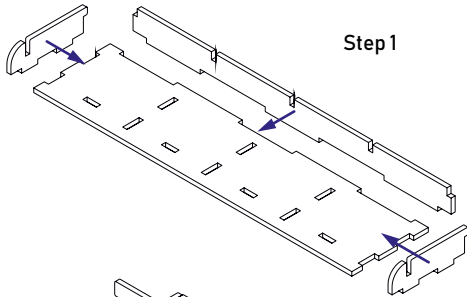

Step 1

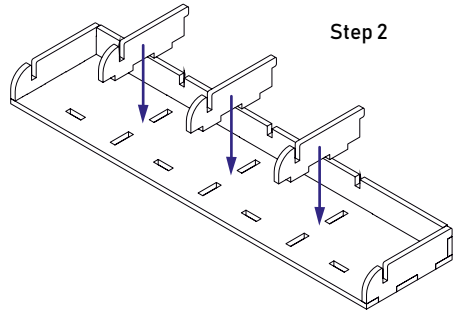

Step 2

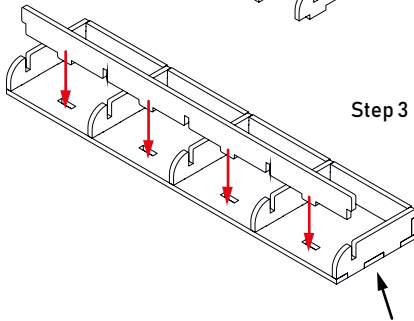

Step 3

The detail shouldn't be glued. Take it out of the tray and put it to the bottom of it before the game. That make it easier to use tokens.

# Gloomhaven® Organizer

GNOR01

Compatible with Gloomhaven®

## Assembly Guide

### Status token tray



Intended for Status Token storage.

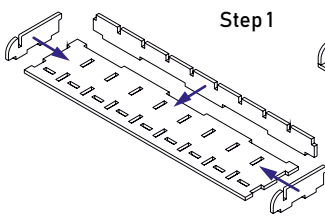
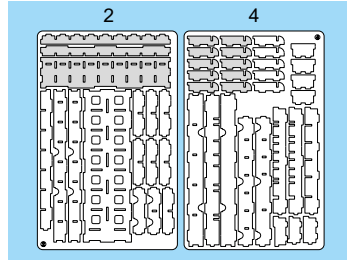
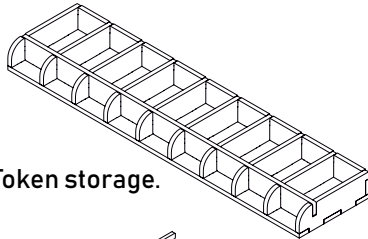

Step 1

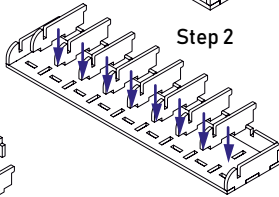

Step 2

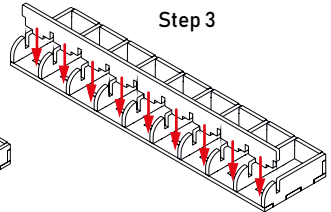

Step 3

The detail shouldn't be glued. Take it out of the tray and put it to the bottom of it before the game. That make it easier to use tokens.

### Attack modifier card holder

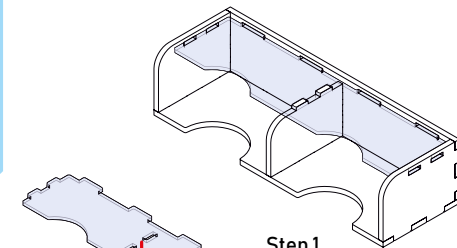

Step 1

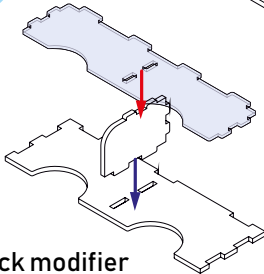

Step 2

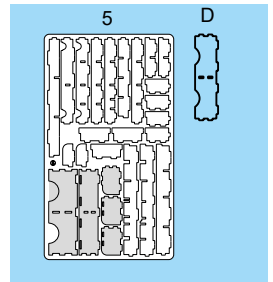

Intended for Attack modifier cards holder storage.



# Gloomhaven® Organizer

GNOR01

Compatible with Gloomhaven®  
Assembly Guide

## Cardholder



Please **DO NOT** take all the parts out of the sheets at once in order not to mix them up. It will help you not get lost in a lot of components.

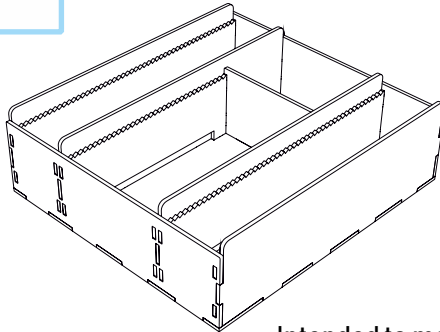
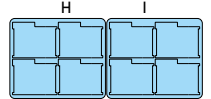
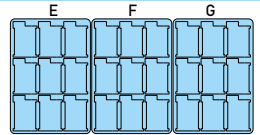
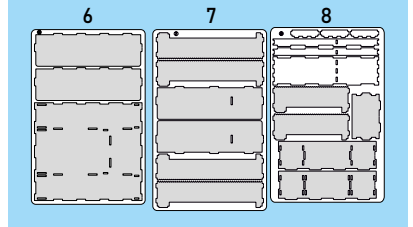

Intended to make it easier to use and store all the cards. Acrylic details are designed to separate cards by type.

Step 1

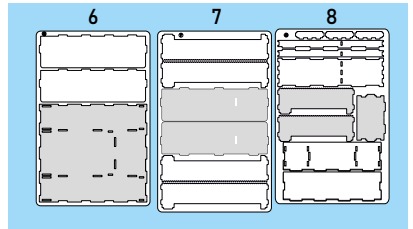
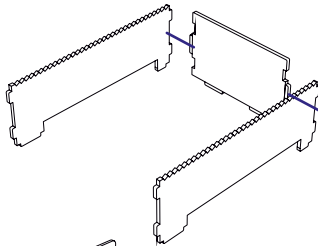

Step 2

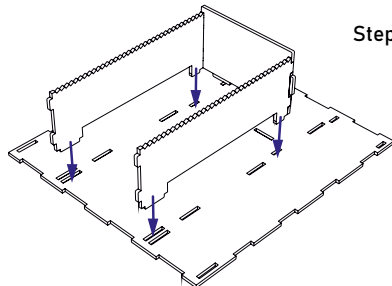

Step 3

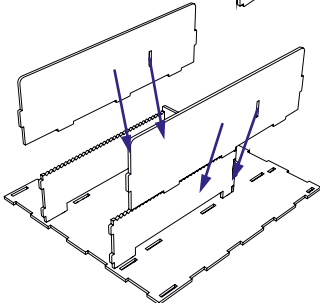

This is a non-licensed product. ALL RIGHTS RESERVED by their respective trademark holders. No challenge to any intellectual property rights is intended or implied by representations of compatibility and no endorsements of any of our products by any other company is implied or represented.



# Gloomhaven® Organizer

GNOR01

Compatible with Gloomhaven®  
Assembly Guide

## Cardholder

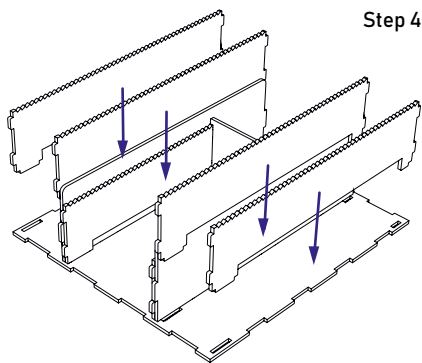
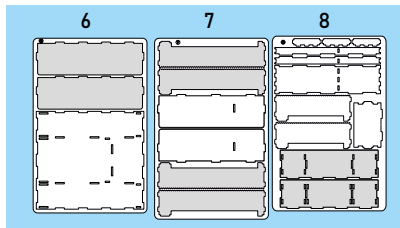

Step 4

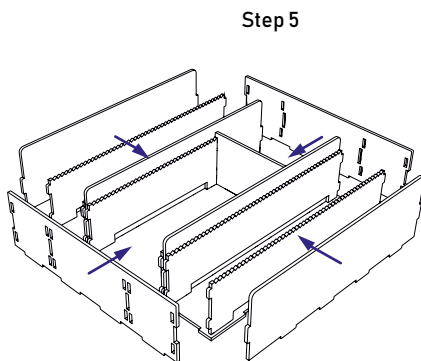

Step 5

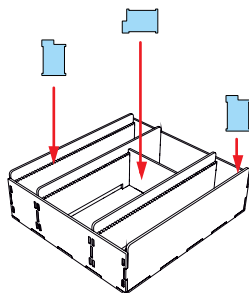

Step 6

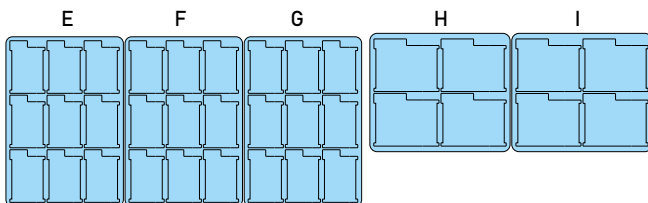

**Extrude the acrylic details from the sheets, remove plastic covering and carefully install them in the cardholder.**

This is a non-licensed product. ALL RIGHTS RESERVED by their respective trademark holders. No challenge to any intellectual property rights is intended or implied by representations of compatibility and no endorsements of any of our products by any other company is implied or represented.



# Gloomhaven® Organizer

GNOR01

Compatible with Gloomhaven®  
Assembly Guide

## Stand tray

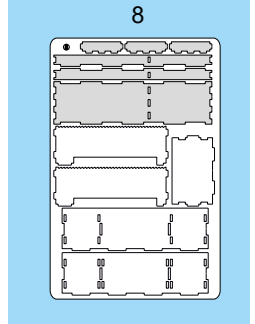
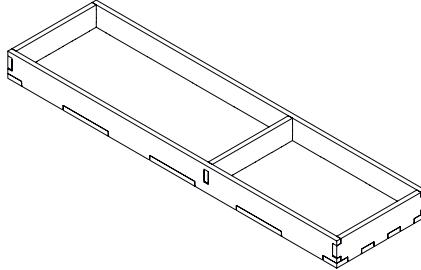

Intended for plastic stands storage.

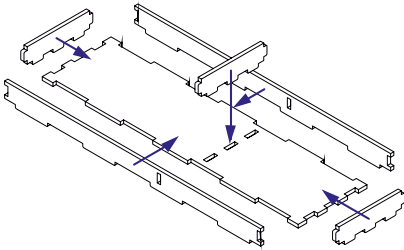

Step 1

## Coin Holder

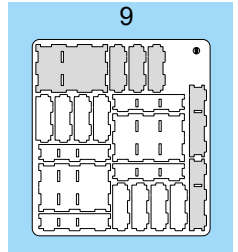
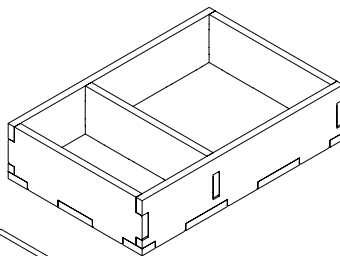

Step 1

Intended for money token storage.

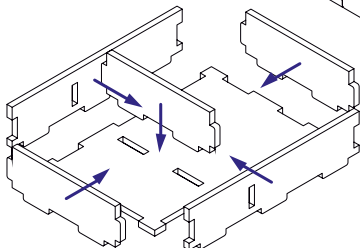

This is a non-licensed product. ALL RIGHTS RESERVED by their respective trademark holders. No challenge to any intellectual property rights is intended or implied by representations of compatibility and no endorsements of any of our products by any other company is implied or represented.



# Gloomhaven® Organizer

GNOR01

Compatible with Gloomhaven®  
Assembly Guide

## Damage tray

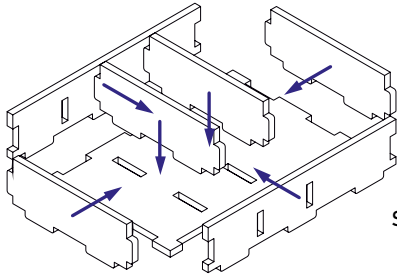
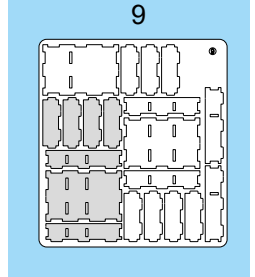
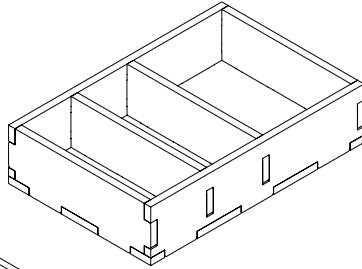

Step 1

Intended for damage token storage.

## Objective token tray

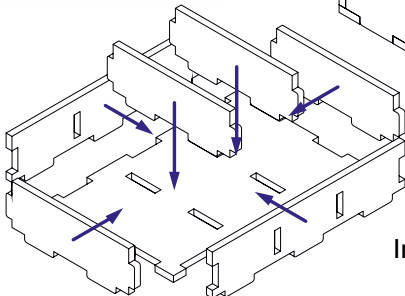
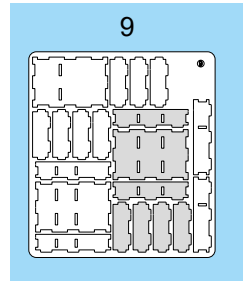
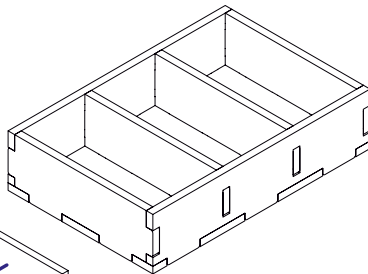

Step 1

Intended for the storage of scenario aid tokens,  
objective tokens and wood element discs.

# Gloomhaven® Organizer

GNOR01

Compatible with Gloomhaven®  
Assembly Guide

## Character tray

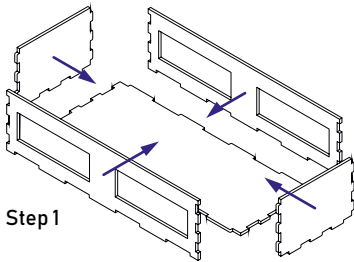
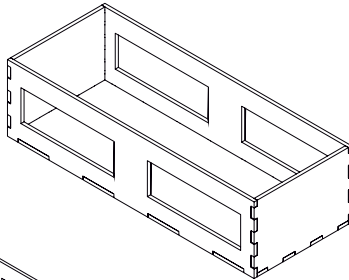

Step 1

Intended for the storage of character miniature boxes.

10

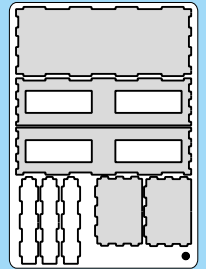

## Monster stat tray

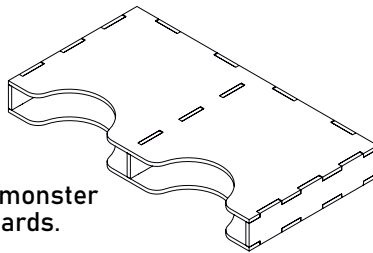

Intended for the storage of monster stat sleeves and event cards.

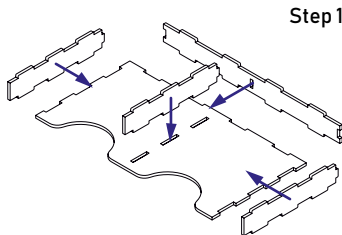

Step 1

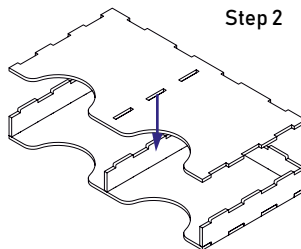

Step 2

10

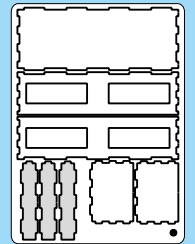

11

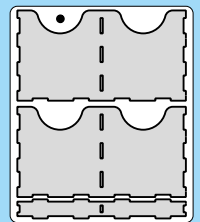



# Gloomhaven® Organizer

GNOR01

Compatible with Gloomhaven®  
Assembly Guide

## Map tiles tray

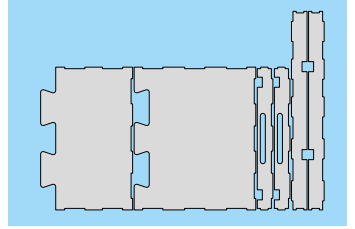
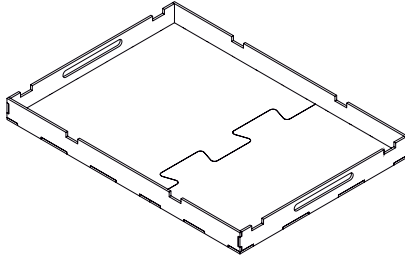

Intended for 2-sided map tiles storage.

Step 1

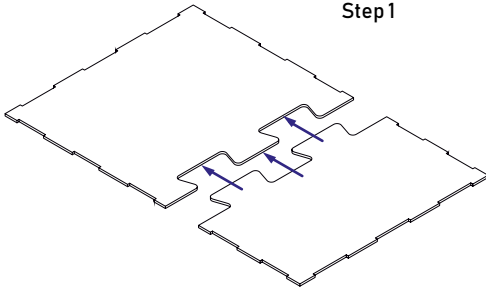

Step 2

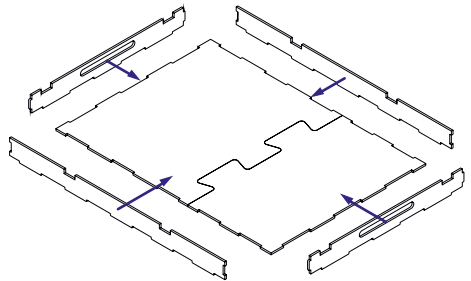

Carefully apply glue to the inner ends of the connecting elements along the entire contact line.



Put map tiles in particular order as shown in the picture.

This is a non-licensed product. ALL RIGHTS RESERVED by their respective trademark holders. No challenge to any intellectual property rights is intended or implied by representations of compatibility and no endorsements of any of our products by any other company is implied or represented.



# Gloomhaven® Organizer

GNOR01

Compatible with Gloomhaven®  
Assembly Guide

## Player board x4

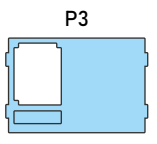
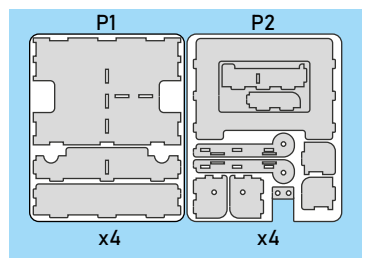
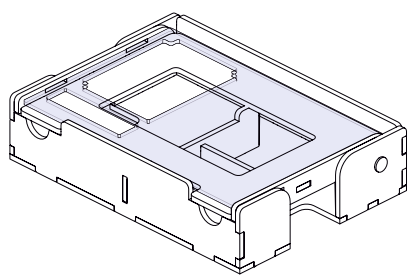

Intended for comfortable game and saving results between your games.

 x8 screws

First of all remove protective covering from the both sides of the acrylic part.

Before the final gluing, make sure the lid fits the tray.

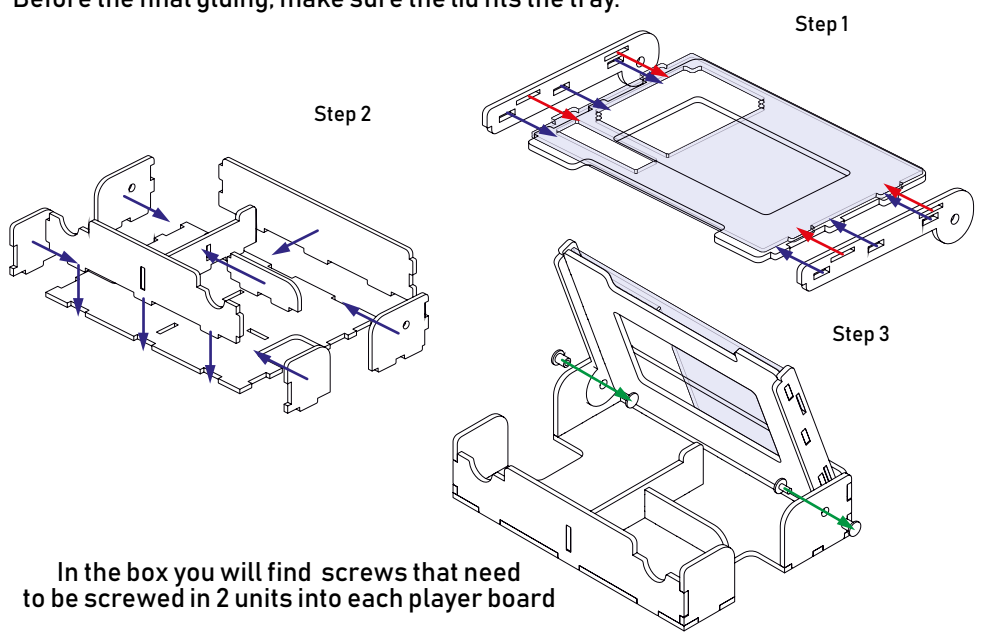

In the box you will find screws that need to be screwed in 2 units into each player board

This is a non-licensed product. ALL RIGHTS RESERVED by their respective trademark holders. No challenge to any intellectual property rights is intended or implied by representations of compatibility and no endorsements of any of our products by any other company is implied or represented.



# Gloomhaven® Organizer GNOR01

Compatible with Gloomhaven®  
Assembly Guide

Other smonex products:

## Gloomhaven® Monster Stands GNMS01



**EASY TO ASSEMBLE**

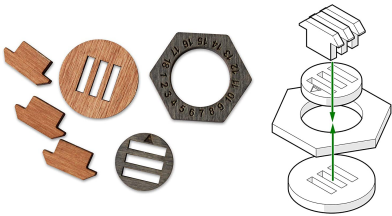

**NO GLUE REQUIRED**



If you have any questions about assembly,  
feel free to contact us through our site:

[smonex.com](http://smonex.com)



Gloomhaven® Organizer  
GNOR01  
Compatible with Gloomhaven®  
Assembly Guide

Other smonex products:

Terraforming Mars Organizer TMOR01



If you have any questions about assembly,  
feel free to contact us through our site:

[smonex.com](http://smonex.com)

This Quick Start Player Board is compatible with Gloomhaven® and its expansions. This is a non-licensed product. ALL RIGHTS RESERVED by their respective trademark holders. No challenge to any intellectual property rights is intended or implied by representations of compatibility and no endorsements of any of our products by any other company is implied or represented.



Gloomhaven® Organizer  
GNOR01  
Compatible with Gloomhaven®  
Assembly Guide

Other smonex products:

XIA Organizer XAOR01



If you have any questions about assembly,  
feel free to contact us through our site:

[smonex.com](http://smonex.com)



Gloomhaven® Organizer GNOR01  
Compatible with Gloomhaven®  
Assembly Guide

Other smonex products:

Carcassonne® Organizer CEOR01



If you have any questions about assembly,  
feel free to contact us through our site:

[smonex.com](http://smonex.com)