



ONE SMART BOX Five Tribes® Organizer

FETSOR01

Compatible with Five Tribes® board game with All Expansions
Assembly Guide



<https://smonex.com>

Created for:

- Five Tribes
with All Expansions

NOT A CHILDREN TOY

AGE 14+

Five Tribes® is a registered trademark of Days of Wonder. Any mention of Five Tribes® is for reference purposes only. ALL RIGHTS RESERVED by their respective trademark holders. No challenge to any intellectual property rights is intended or implied by representations of compatibility and no endorsements of any of our products by any other company is implied or represented.



ONE SMART BOX

Five Tribes® Organizer

FETSOR01

Compatible with Five Tribes® board game with All Expansions
Assembly Guide

Tips and tricks

- To assemble each tray you need a wood glue for extra strength. (We recommend Titebond 2 Wood Glue or Beacon 527)
- Please make sure you assembled each tray correctly before gluing it together.
- Use stationery knife to cut the bits that connect details to the frame.
- Remove the details from the frame with a rotational motion along the axis formed by the bits you just cut.
- Make sure to remove the protective covering from BOTH sides of the acrylic pieces. Use a hairdryer for easier removal of it if necessary. Just heat the acrylic surface a little to remove the covering much easier.
- You may fix the box with rubber bands after gluing it. This will save you time and simplify the assembly.
- Leave your finished insert overnight to dry completely.

Assembly Supplies



Wood-glue



Stationery knife



Hammer



Cotton swab



Rubber bands



Hairdryer

If something is damaged or broken, please do not return the whole set. Contact us directly on email info@smonex.com or our website smonex.com. Any questions or issues with the Smonex products, we'll do our best to help you. We want our customers to be completely satisfied.

IMPORTANT: Assemble each tray one by one. Please DO NOT take out all the parts from the sheets and mix them. Even though some parts look similar, they are not interchangeable.



ONE SMART BOX Five Tribes® Organizer

FETSOR01

Compatible with Five Tribes® board game with All Expansions
Assembly Guide

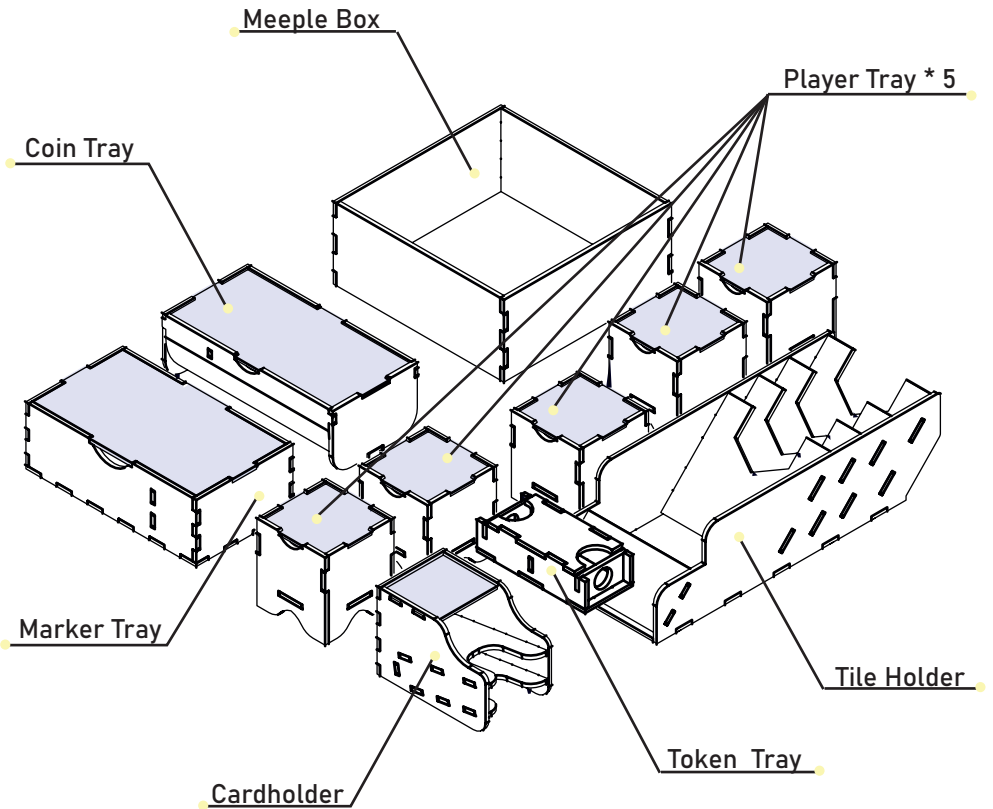



ONE SMART BOX Five Tribes® Organizer

FETSOR01

Compatible with Five Tribes® board game with All Expansions
Assembly Guide

- Brief assembly instructions:**
1. Unpack and arrange the sheets in order.
 2. Compare details on the sheets with details in the pictures of the guide.
 3. Study the pictures of unassembled product.
 4. Start your assembly, taking the necessary parts out of the sheets in a certain order.

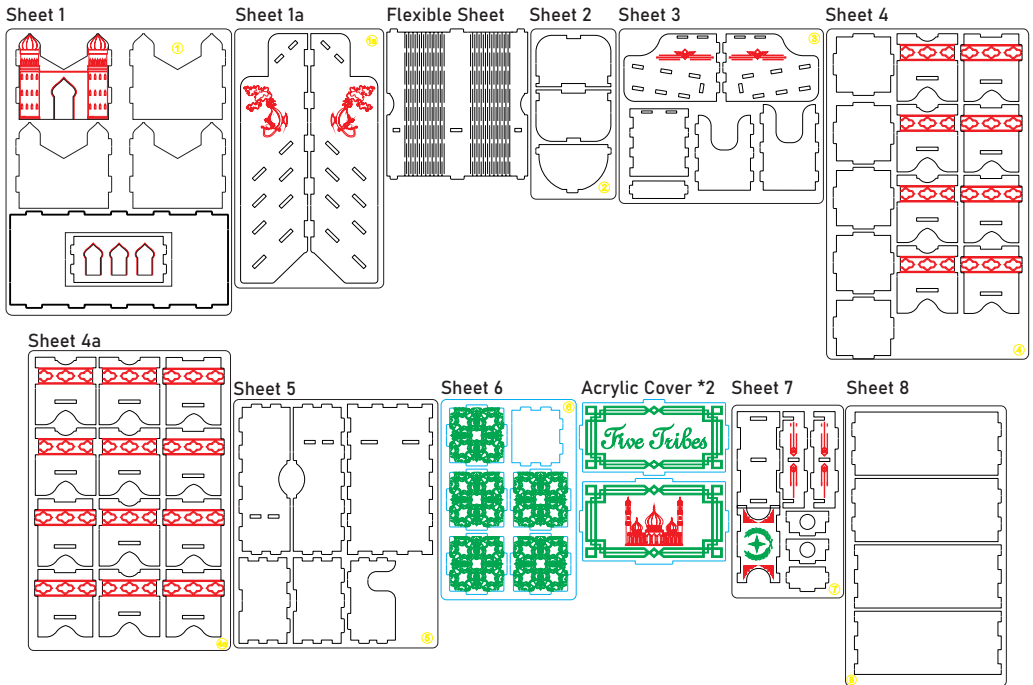

Legend:

- ➡ Details to be glued
- ➡ Details to be connected without glue

Components:

- 9 sheets extrusion molds
- 2 acrylic lids
- 1 acrylic sheet extrusion mold
- 1 flexible sheet
- 1 sandpaper for stripping parts
- Assembly guide



ONE SMART BOX Five Tribes® Organizer

FETSOR01

Compatible with Five Tribes® board game with All Expansions
Assembly Guide

Tile Holder

Intended for Villages & Sacred Places tiles, Markets & Oasis tiles and Djinn cards.

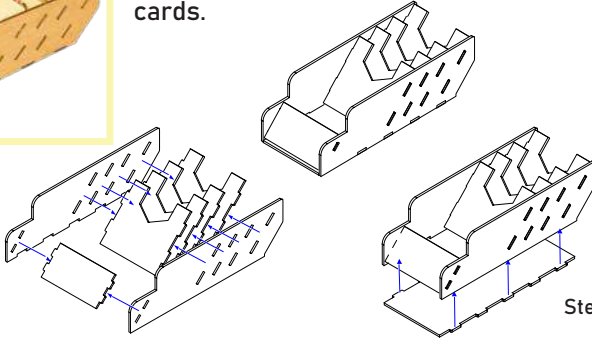

Step 1

Step 2

Sheets 1, 1a

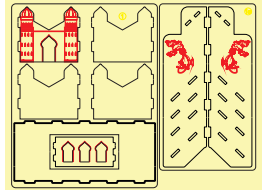

Please note that the engraving must be on the outside of the boxes.

Coin Tray

Intended for Gold Coins.

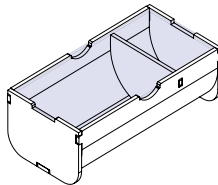

Sheet 2, Flexible Sheet,
Acrylic Cover

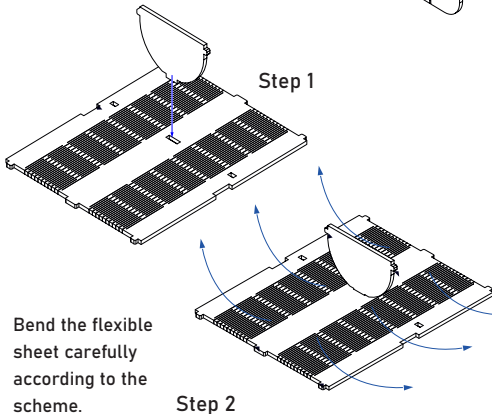
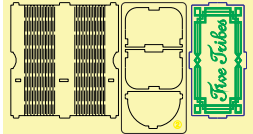

Step 1

Step 2

Step 3

Until the glue has completely dried, make sure the lid fits the tray and can be easily removed. Put it back in its place on the tray. Only then carefully remove the protective covering.

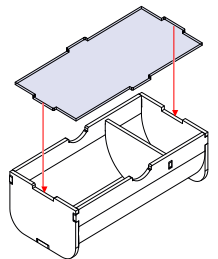

Step 4

Bend the flexible sheet carefully according to the scheme.



ONE SMART BOX Five Tribes® Organizer

FETSOR01
Compatible with Five Tribes® board game with All Expansions
Assembly Guide

Cardholder



Intended for Resource and
Whim of the Sultan cards.

Please note that the
engraving must be on the
outside of the boxes.

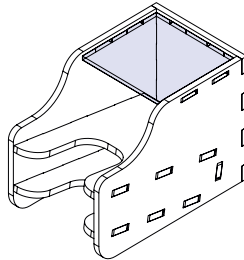

Sheets 3, 6

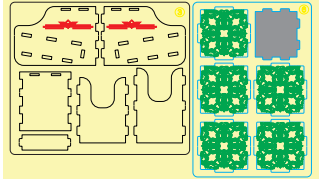

Make sure to remove the
protective covering from
BOTH sides of the acrylic
pieces BEFORE starting
the assembly.

Step 1

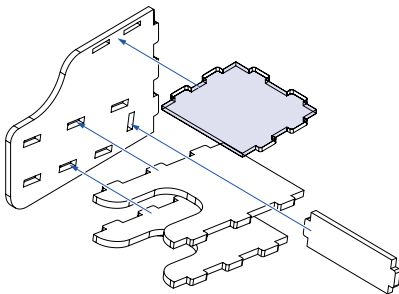

Step 2

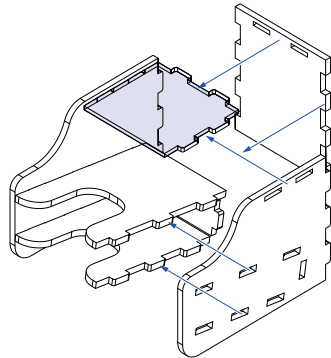



ONE SMART BOX Five Tribes® Organizer

FETSOR01
Compatible with Five Tribes® board game with All Expansions
Assembly Guide

Player Tray * 5



Intended for Player sets of Camels and Player's Turn markers.

Please note that the engraving must be on the outside of the boxes.

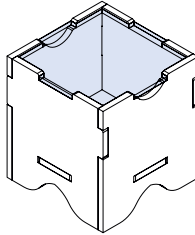

Sheets 4, 4a, 6

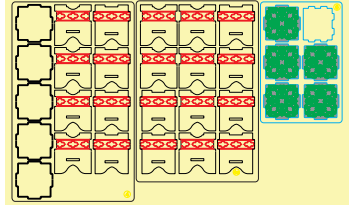

Until the glue has completely dried, make sure the lid fits the tray and can be easily removed. Put it back in its place on the tray. Only then carefully remove the protective covering.

Step 1

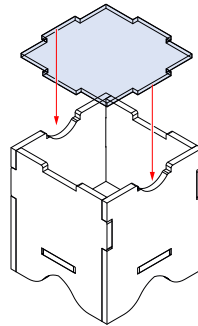
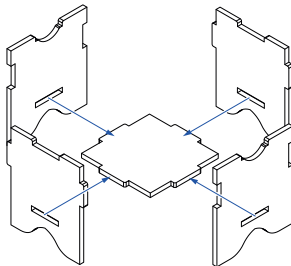

Step 2



ONE SMART BOX Five Tribes® Organizer

FETSOR01
Compatible with Five Tribes® board game with All Expansions
Assembly Guide

Marker Tray

Intended for Palm Trees
and Palaces.



Sheet 5, Acrylic Cover

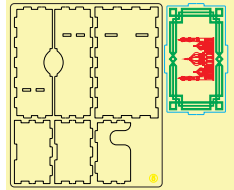

Until the glue has completely dried, make sure the lid fits the tray and can be easily removed. Put it back in its place on the tray. Only then carefully remove the protective covering.

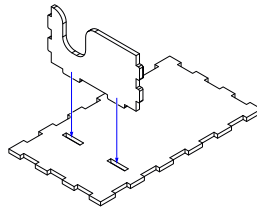
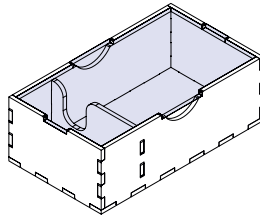

Step 1

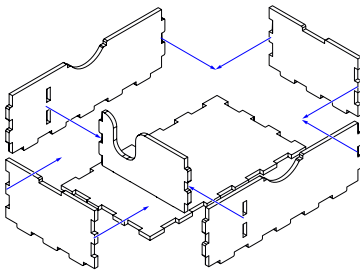

Step 2

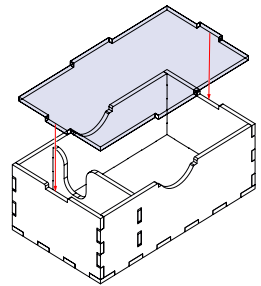

Step 3



ONE SMART BOX Five Tribes® Organizer

FETSOR01
Compatible with Five Tribes® board game with All Expansions
Assembly Guide

Token Tray

Intended for Tokens.



Please note that the engraving must be on the outside of the boxes.

Sheet 7

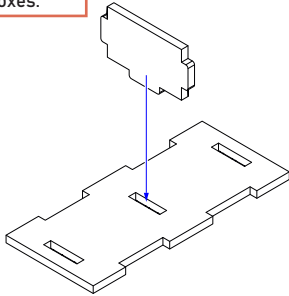
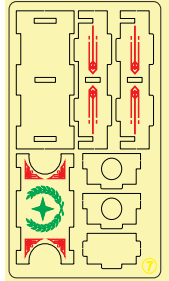

Step 1

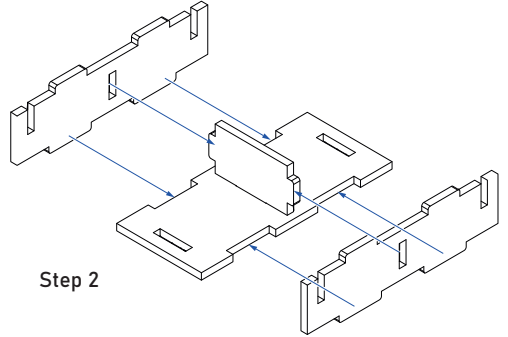

Step 2

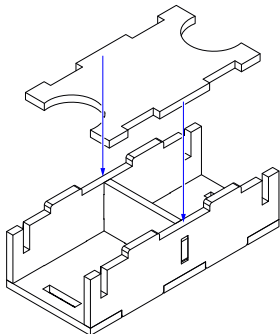

Step 3

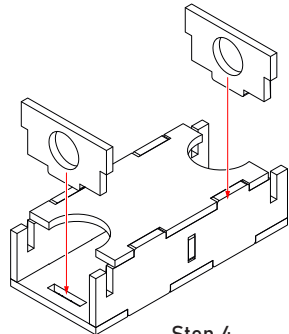

Step 4



ONE SMART BOX Five Tribes® Organizer

FETSOR01
Compatible with Five Tribes® board game with All Expansions
Assembly Guide

Meeple Box

Intended for Wooden Tribe
Meeples.

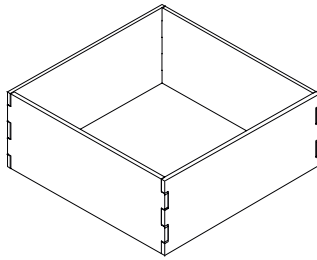

Sheet 8

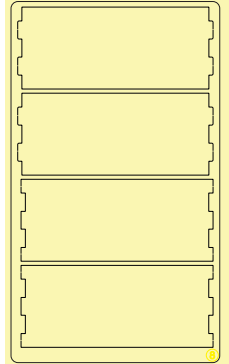

Step 1

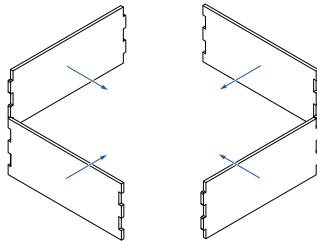



ONE SMART BOX

Some other SMONEX products:

Architects of the West Kingdom® Organizer AWKOR01



The Castles of Burgundy® (20th Anniversary Edition)
Organizer CBOR01





ONE SMART BOX

Welcome to <https://smonex.com>.

If something is damaged or broken, please do not return the whole set. Contact us directly on email info@smonex.com or our website smonex.com.

Any questions or issues with the Smonex products, we'll do our best to help you. Your satisfaction of it is our top priority.

Thanks for choosing Smonex product. We would be grateful for your feedback, which inspires us and helps to develop further. We'll gladly help you on any matter if you contact us on info@smonex.com.

Share your photos with #smonex and follow us for all the updates:

 <https://www.facebook.com/Smonexcom>

 https://www.instagram.com/smonex_com/

 https://twitter.com/Smonex_com

 https://www.pinterest.com/smonex/_shop/

 <https://www.youtube.com/c/SmonexSmartOneBox>



Scan QR-code to visit or follow Smonex.