



ONE SMART BOX Dead of Winter: The Long Night® Organizer

DWLNOR01

Compatible with Dead of Winter: The Long Night® + all promo packs
Assembly Guide



<https://smonex.com>

NOT A CHILDREN TOY

AGE 14+

Created for Dead of Winter: The Long Night with all promo packs.

Dead of Winter: The Long Night® is a registered trademark of Plaid Hat Games. Any mention of Dead of Winter: The Long Night® is for reference purposes only. ALL RIGHTS RESERVED by their respective trademark holders. No challenge to any intellectual property rights is intended or implied by representations of compatibility and no endorsements of any of our products by any other company is implied or represented.



ONE SMART BOX

Dead of Winter: The Long Night® Organizer

DWLNOR01

Compatible with Dead of Winter: The Long Night® + all promo packs
Assembly Guide

Tips and tricks

- To assemble each tray you need a wood glue for extra strength. (We recommend Titebond 2 Wood Glue or Beacon 527)
- Please make sure you assembled each tray correctly before gluing it together.
- Use stationery knife to cut the bits that connect details to the frame.
- Remove the details from the frame with a rotational motion along the axis formed by the bits you just cut.
- Use stationery knife and sandpaper to remove all the remaining connection bits.
- You may fix the box with rubber bands after gluing it. This will save you time and simplify the assembly.
- Leave your finished insert overnight to dry completely.

Assembly Supplies



Wood-glue



Stationery knife



Hammer



Cotton swab



Rubber bands

If something is damaged or broken, please do not return the whole set. Contact us directly on email info@smonex.com or our website smonex.com. Any questions or issues with the Smonex products, we'll do our best to help you. We want our customers to be completely satisfied.

IMPORTANT: Assemble each tray one by one. Please DO NOT take out all the parts from the sheets and mix them. Even though some parts look similar, they are not interchangeable.



ONE SMART BOX

Dead of Winter: The Long Night[®] Organizer

DWLNOR01

Compatible with Dead of Winter: The Long Night[®] + all promo packs
Assembly Guide

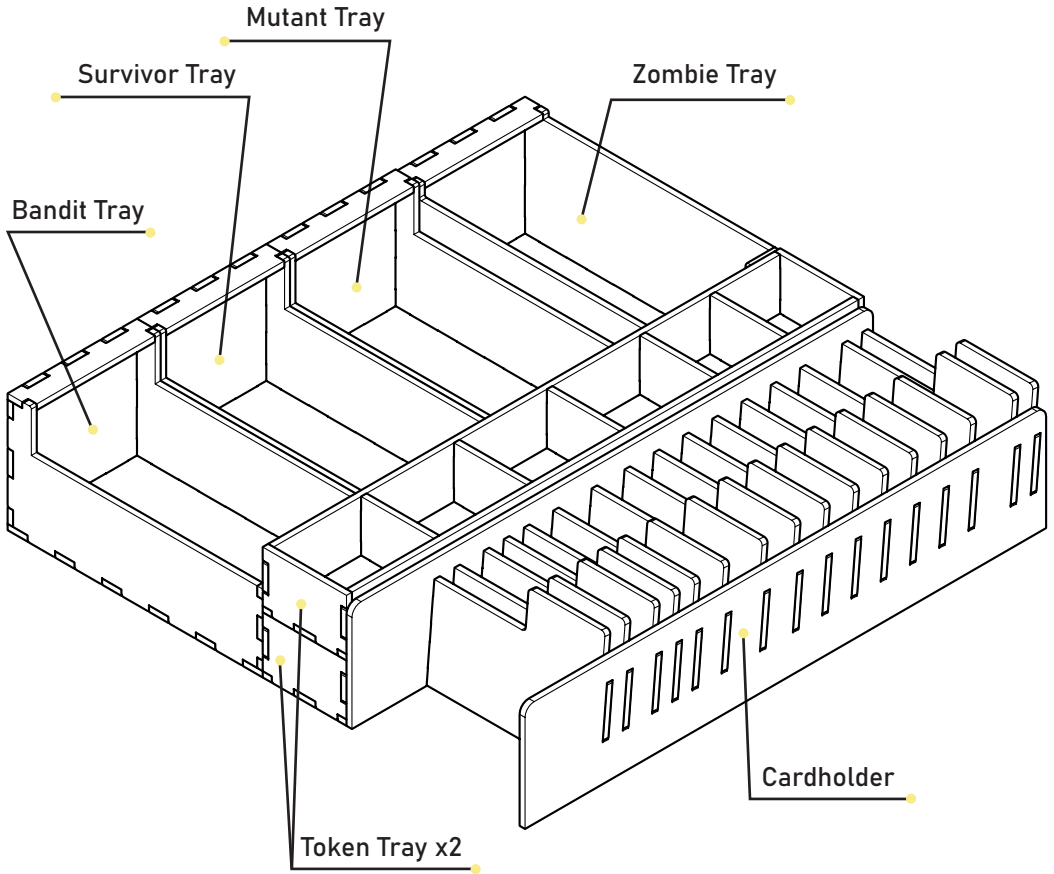



ONE SMART BOX

Dead of Winter: The Long Night® Organizer



DWLNOR01

Compatible with Dead of Winter: The Long Night® + all promo packs
 Assembly Guide

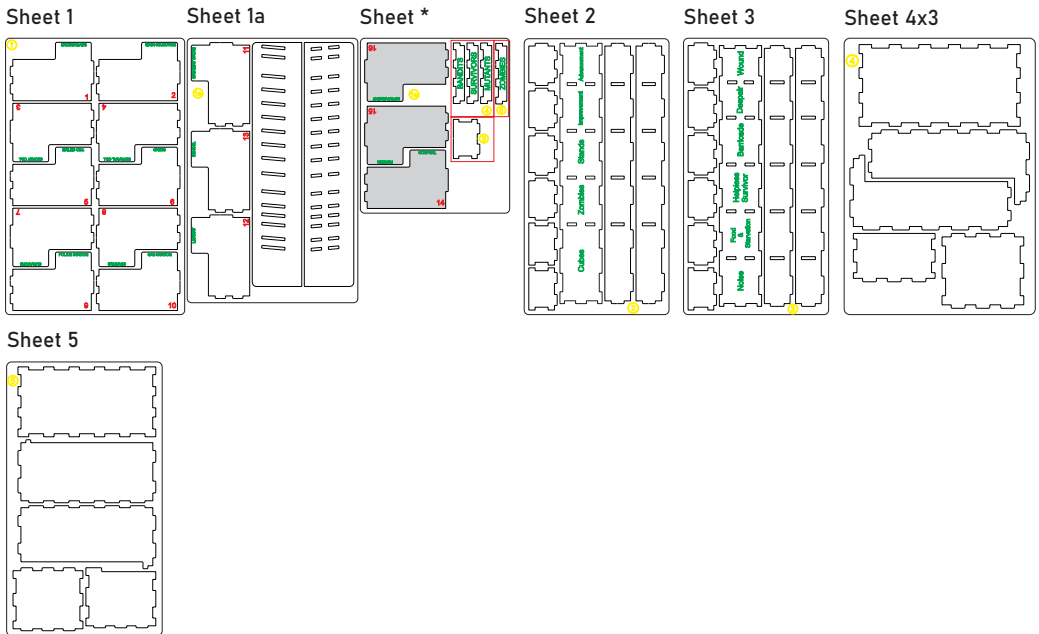
- Brief assembly instructions:**
1. Unpack and arrange the sheets in order.
 2. Compare details on the sheets with details in the pictures of the guide.
 3. Study the pictures of unassembled product.
 4. Start your assembly, taking the necessary parts out of the sheets in a certain order.



Legend:

-  Highlighted details to be extruded
-  Details not used in this assembly
-  Details to be glued

Components:

- 9 sheets extrusion molds
- 1 sandpaper for stripping parts
- Assembly guide



ONE SMART BOX Dead of Winter: The Long Night® Organizer

DWLNOR01

Compatible with Dead of Winter: The Long Night® + all promo packs
Assembly Guide

Cardholder

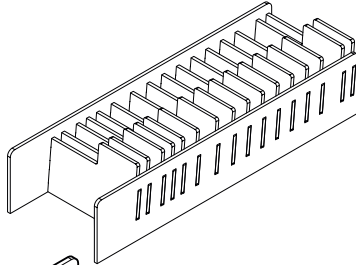

Sheets 1, 1a, *

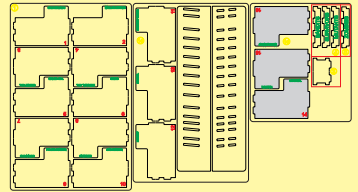

Step 1

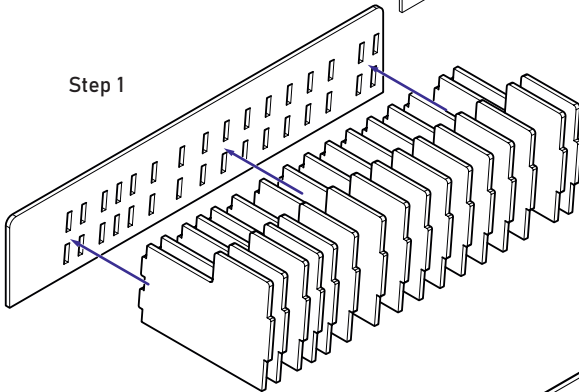

Intended for all the cards in the game.

Step 2

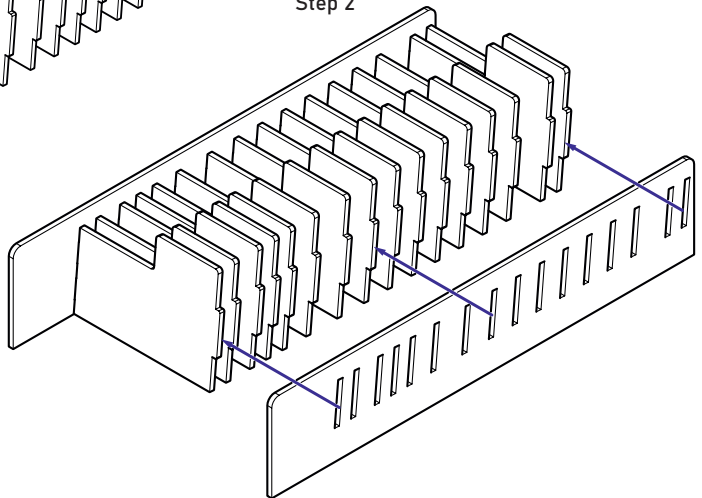

The Cardholder should stay in the game box as it doesn't have a bottom part.



ONE SMART BOX

Dead of Winter: The Long Night® Organizer

DWLNOR01

Compatible with Dead of Winter: The Long Night® + all promo packs
Assembly Guide

Bottom Token Tray

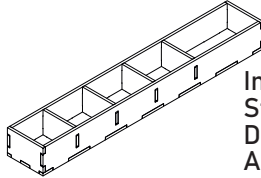

Intended for Plastic Standee Stands, Exposure and Action Dice, Improvement Tokens, Advancement Tokens, Zombie Tokens. Follow the engravings.

Sheet 2

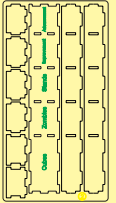

Step 1

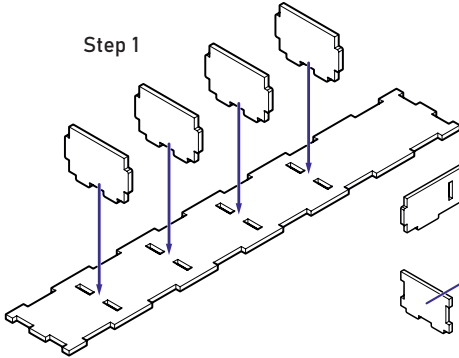

Step 2

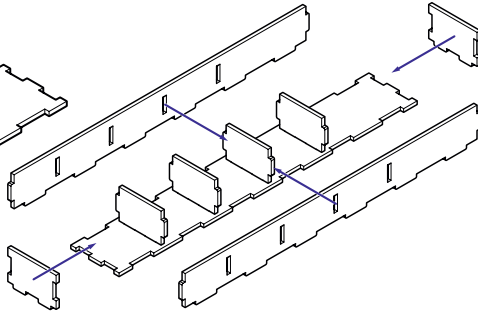

Top Token Tray

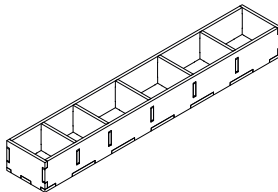

Sheet 3

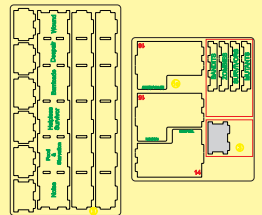

Step 1

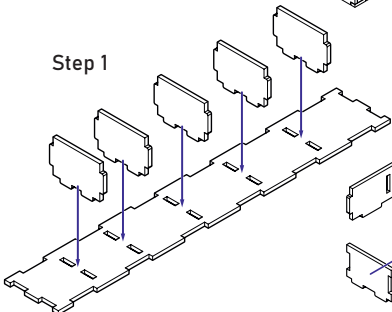

Step 2

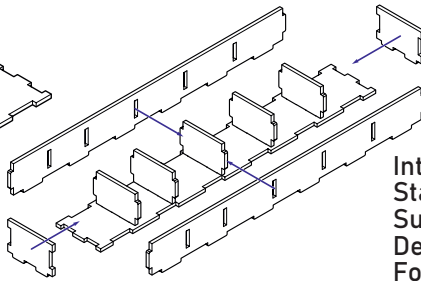

Intended for Noise, Food, Starvation, Helpless Survivor, Barricade, Despair, Wound Tokens. Follow the engravings.



ONE SMART BOX

Dead of Winter: The Long Night® Organizer

DWLNOR01

Compatible with Dead of Winter: The Long Night® + all promo packs
Assembly Guide

Survivor, Bandit, Mutant Trays

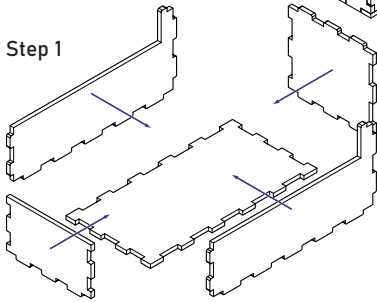

Step 2

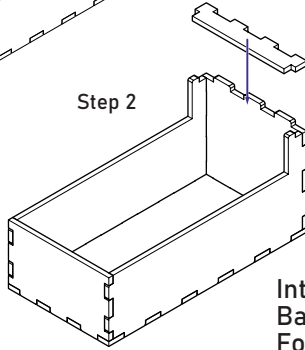

Sheet 4x3

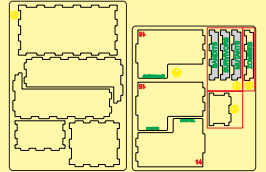

Intended for Survivor,
Bandit, Mutant Standees.
Follow the engravings.

Zombie Tray

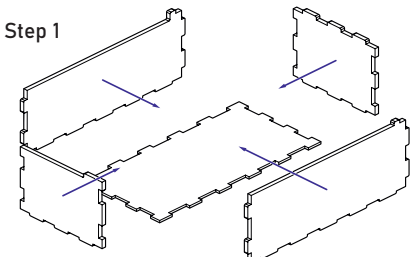

Step 2

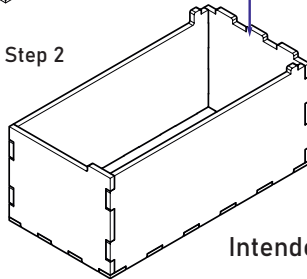

Sheet 5

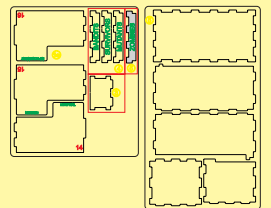

Intended for Zombie Standees.



ONE SMART BOX

Some other SMONEX products:

Gloomhaven Organizer GNOR01

Betrayal at the House on the Hill Organizer BLOR01



Welcome to <https://smonex.com>.

If something is damaged or broken, please do not return the whole set. Contact us directly on email info@smonex.com or our website smonex.com.

Any questions or issues with the Smonex products, we'll do our best to help you. Your satisfaction of it is our top priority.

Thanks for choosing Smonex product. We would be grateful for your feedback, which inspires us and helps to develop further.

We'll gladly help you on any matter if you contact us on info@smonex.com.

Share your photos with #smonex and follow us for all the updates:

<https://www.facebook.com/Smonexcom>

https://www.instagram.com/smonex_com/

https://twitter.com/Smonex_com

https://www.pinterest.com/smonex/_shop/

<https://www.youtube.com/c/SmonexSmartOneBox>



Scan QR-code to visit or follow Smonex.