



# ONE SMART BOX The Castles of Burgundy® (20th Anniversary Edition) Organizer

Compatible with The Castles of Burgundy® (2019) including all expansions  
Assembly Guide



<https://smonex.com>

NOT A CHILDREN TOY

**AGE 14+**

Created for The Castles of Burgundy®  
(20th Anniversary Edition) including all expansions

The Castles of Burgundy® is a registered trademark of Ravensburger. Any mention of The Castles of Burgundy® is for reference purposes only. ALL RIGHTS RESERVED by their respective trademark holders. No challenge to any intellectual property rights is intended or implied by representations of compatibility and no endorsements of any of our products by any other company is implied or represented.



# ONE SMART BOX The Castles of Burgundy® (20th Anniversary Edition) Organizer

Compatible with The Castles of Burgundy® (2019) including all expansions  
Assembly Guide

## Tips and tricks

- To assemble each tray you need a wood glue for extra strength. (We recommend Titebond 2 Wood Glue or Beacon 527)
- Please make sure you assembled each tray correctly before gluing it together.
- Use stationery knife to cut the bits that connect details to the frame.
- Remove the details from the frame with a rotational motion along the axis formed by the bits you just cut.
- Use stationery knife and sandpaper to remove all the remaining connection bits.
- You may fix the box with rubber bands after gluing it. This will save you time and simplify the assembly.
- Make sure to remove the protective covering from both sides of the acrylic pieces. Use a hairdryer for easier removal of it if necessary. Just heat the acrylic surface a little to remove the covering much easier!
- Leave your finished insert overnight to dry completely.

## Assembly Supplies



Wood-glue



Stationery knife



Hammer



Cotton swab



Rubber bands



Hairdryer

If something is damaged or broken, please do not return the whole set. Contact us directly on email [info@smonex.com](mailto:info@smonex.com) or our website [smonex.com](http://smonex.com). Any questions or issues with the Smonex products, we'll do our best to help you. We want our customers to be completely satisfied.

**IMPORTANT:** Assemble each tray one by one. Please DO NOT take out all the parts from the sheets and mix them. Even though some parts look similar, they are not interchangeable.



# ONE SMART BOX The Castles of Burgundy® (20th Anniversary Edition) Organizer

Compatible with The Castles of Burgundy® (2019) including all expansions  
Assembly Guide

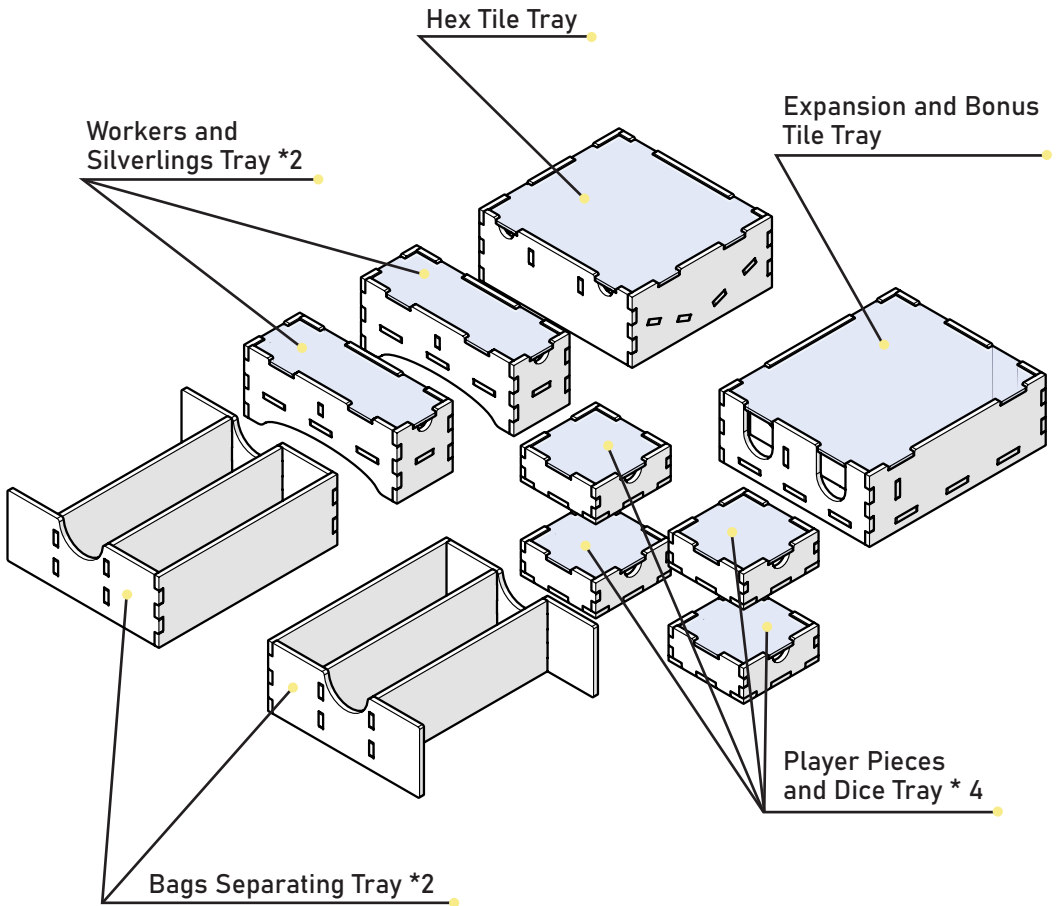



# ONE SMART BOX

## The Castles of Burgundy® (20th Anniversary Edition) Organizer

Compatible with The Castles of Burgundy® (2019) including all expansions  
Assembly Guide

- Brief assembly instructions:**
1. Unpack and arrange the sheets in order.
  2. Compare details on the sheets with details in the pictures of the guide.
  3. Study the pictures of unassembled product.
  4. Start your assembly, taking the necessary parts out of the sheets in a certain order.

Sheet 1

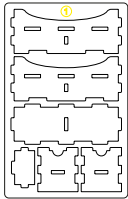

Sheet 2

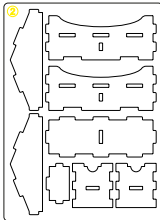

Sheet 3

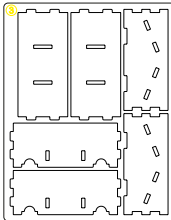

Sheet 4



Sheets 5

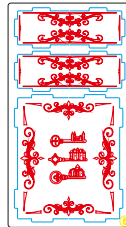

Sheet 6

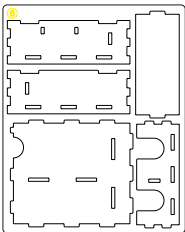

Sheet 7

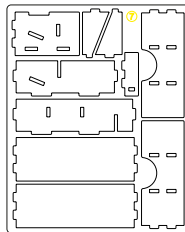

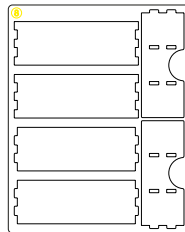

Sheet 8

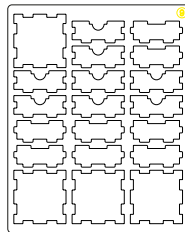

Sheet 9



### Legend:

-  Highlighted details to be extruded
-  Details not used in this assembly
-  Details to be glued

### Components:

- 8 sheets extrusion molds
- 2 acrylic sheets extrusion molds
- 6 token bags
- 1 sandpaper for stripping parts
- Assembly guide



# ONE SMART BOX The Castles of Burgundy® (20th Anniversary Edition) Organizer

Compatible with The Castles of Burgundy® (2019) including all expansions  
Assembly Guide

## Workers and Silverlings Tray \*2

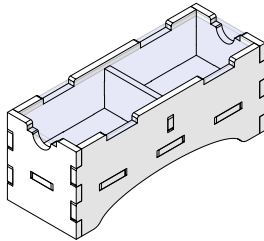

Sheets 1, 2, 5

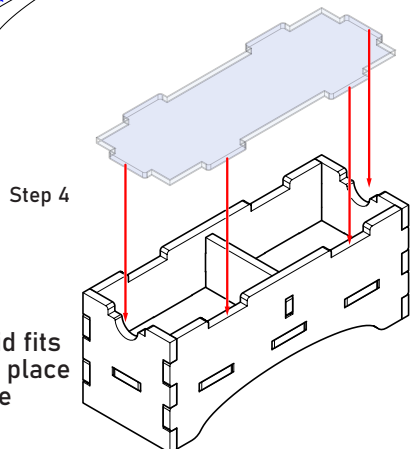
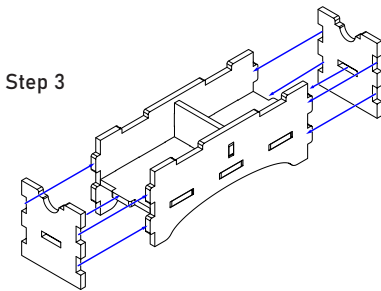
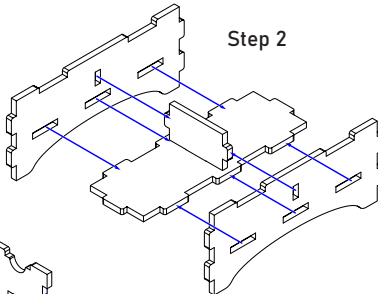
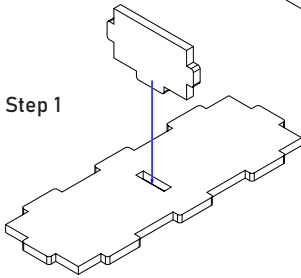
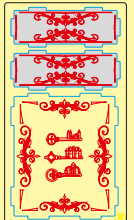
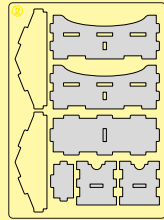
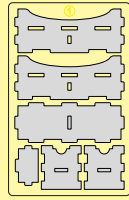

Intended for Worker  
tiles and Silverlings.

Until the glue has completely dried, make sure the lid fits the tray and can be easily removed. Put it back in its place on the tray. Only then carefully remove the protective covering.



# ONE SMART BOX The Castles of Burgundy® (20th Anniversary Edition) Organizer

Compatible with The Castles of Burgundy® (2019) including all expansions  
Assembly Guide

## Hex Tile Tray

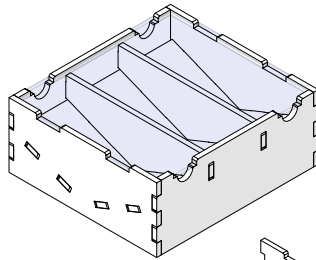

Sheets 2,3,4

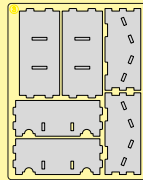
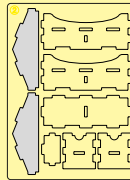

Intended for Hex Tiles.

Step 1

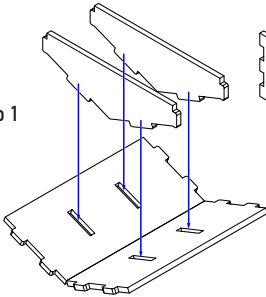

Step 2

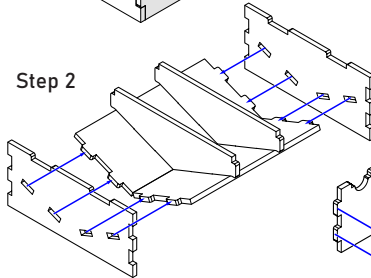

Step 3

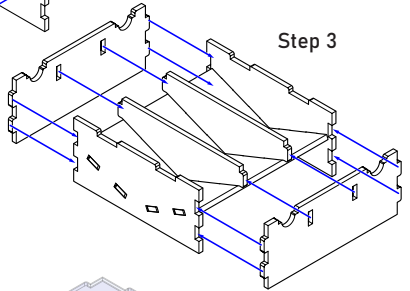

Until the glue has completely dried, make sure the lid fits the tray and can be easily removed. Put it back in its place on the tray. Only then carefully remove the protective covering.

Step 4

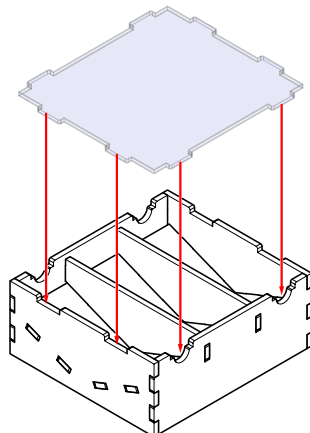



# ONE SMART BOX The Castles of Burgundy® (20th Anniversary Edition) Organizer

Compatible with The Castles of Burgundy® (2019) including all expansions  
Assembly Guide

## Expansion and Bonus Tile Tray

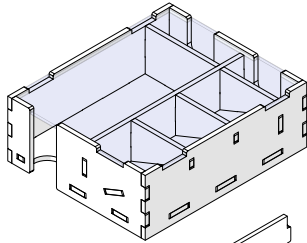

Sheets 5,8,7

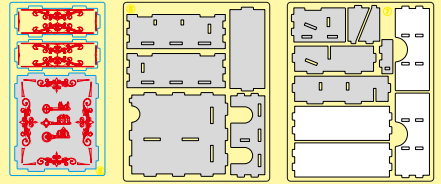

Step 1

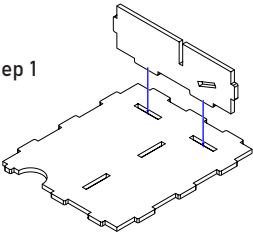

Step 2

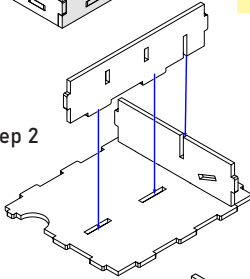

Intended for Expansions  
and Bonus Tiles.

Step 3

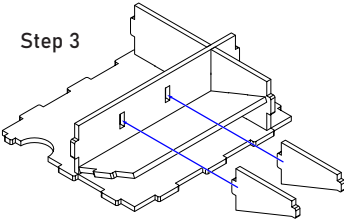

Step 4

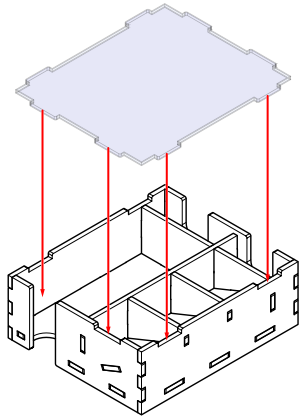
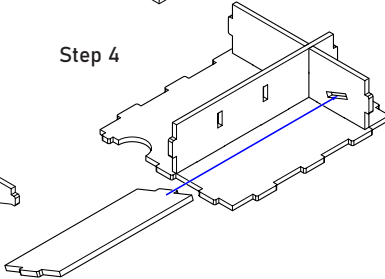

Step 5

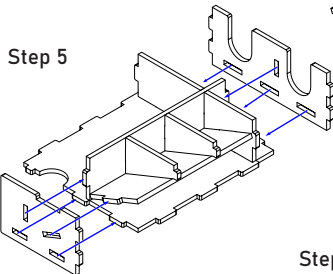

Step 6

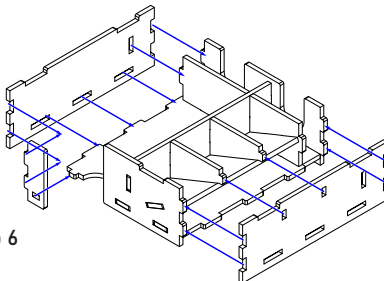

Step 7

Until the glue has completely dried, make sure the lid fits the tray and can be easily removed. Put it back in its place on the tray. Only then carefully remove the protective covering.



# ONE SMART BOX The Castles of Burgundy® (20th Anniversary Edition) Organizer

Compatible with The Castles of Burgundy® (2019) including all expansions  
Assembly Guide

## Bags Separating Tray \*2

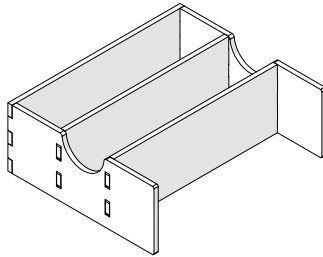

Sheets 7,8

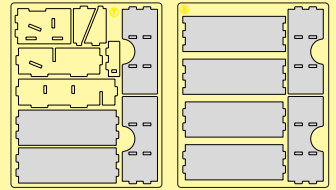

Step 1

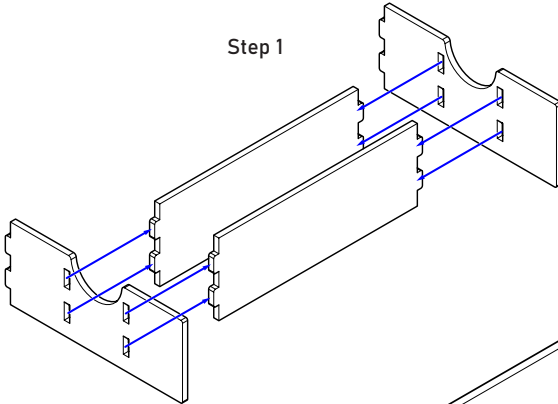

Intended for separating  
bags with tokens.

Step 2

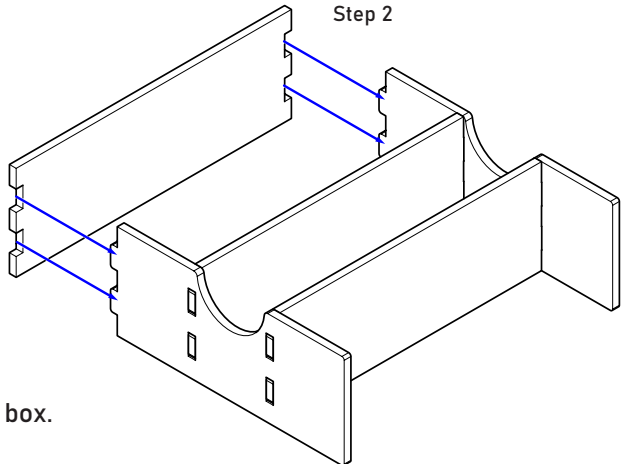

The trays should stay in the box.





# ONE SMART BOX The Castles of Burgundy® (20th Anniversary Edition) Organizer

Compatible with The Castles of Burgundy® (2019) including all expansions  
Assembly Guide

## Player Pieces and Dice Tray \* 4

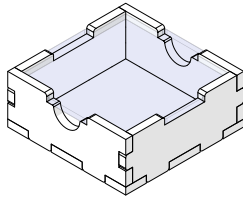

Sheets 4,9

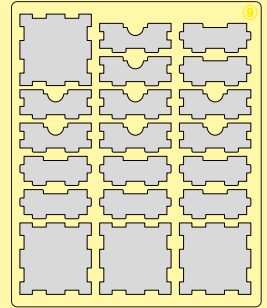
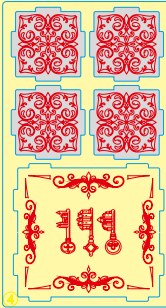

Intended for Player Tokens and Dice.

Step 1

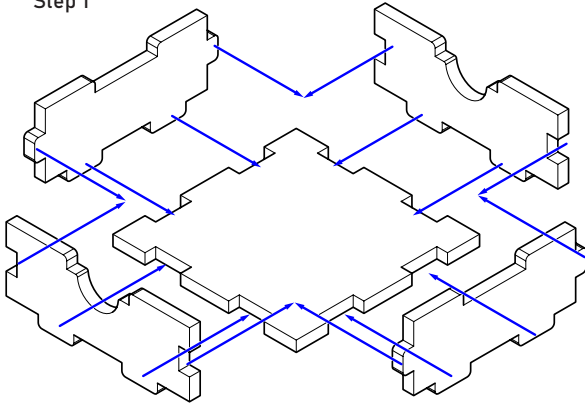

Step 2

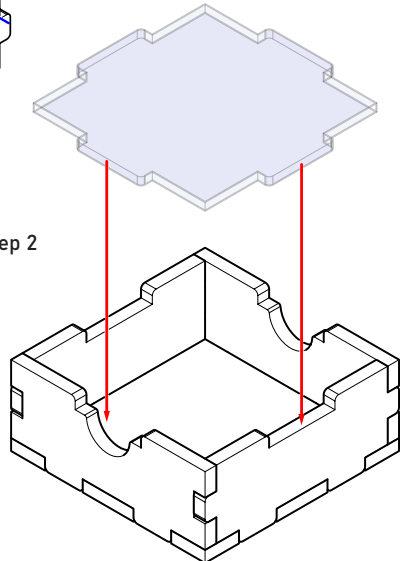

Until the glue has completely dried, make sure the lid fits the tray and can be easily removed. Put it back in its place on the tray. Only then carefully remove the protective covering.



ONE SMART BOX

Some other SMONEX products:

Gloomhaven: Jaws of the Lion® Organizer JLOR01



Wingspan® Organizer WNOR01





ONE SMART BOX

## Terraforming Mars TMOR01



## Scythe SEOR01









Welcome to <https://smonex.com>.

If something is damaged or broken, please do not return the whole set. Contact us directly on email [info@smonex.com](mailto:info@smonex.com) or our website [smonex.com](https://smonex.com).

Any questions or issues with the Smonex products, we'll do our best to help you. Your satisfaction of it is our top priority.

Thanks for choosing Smonex product. We would be grateful for your feedback, which inspires us and helps to develop further. We'll gladly help you on any matter if you contact us on [info@smonex.com](mailto:info@smonex.com).

Share your photos with #smonex and follow us for all the updates:

-  <https://www.facebook.com/Smonexcom>
-  [https://www.instagram.com/smonex\\_com/](https://www.instagram.com/smonex_com/)
-  [https://twitter.com/Smonex\\_com](https://twitter.com/Smonex_com)
-  [https://www.pinterest.com/smonex/\\_shop/](https://www.pinterest.com/smonex/_shop/)
-  <https://www.youtube.com/c/SmonexSmartOneBox>



Scan QR-code to visit or follow Smonex.