



Available colours

* Selected colours are available on request only; Please confirm stock availability.



Output range Kw	9.4-15.5
Eco Design 2022 / Nom. Kw	9.4
Heating Capacity m³	470
Nominal Efficiency %	75
Type	Built-In
Fuel Type	Wood
Max load / Nom. Cons. Kg/h	2.5
Brand	C&A Chama
Category	Traditional Wood
Flue ø	200
Flue exit	Top
WxDxH mm	980 x 520 x 552
Weight Kg	184
Hopper capacity Kg	-
Finish	Steel
Ash tray	Yes
Glass cleaning air flow	Yes
Convection type	Natural, Opt. Forced
Multifire System	-
Dual power system	-
Ductable	-
Power settings	-
Remote control	-
Energy saving mode	-
Humidifier	-
Warranty	5 Yr. Structural Steel 2 Yr. Elec. & Mech.

* All warranties are subject to CRMS registration.



	A	B	C	D	E	F	Ø FLUE
FIREBOX CRISTAL 98 D	980	552	520	161	487	923	200

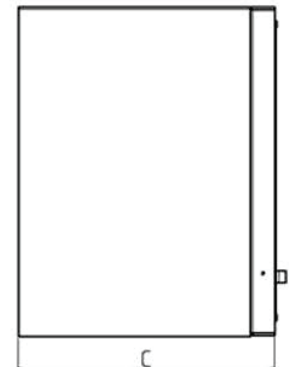
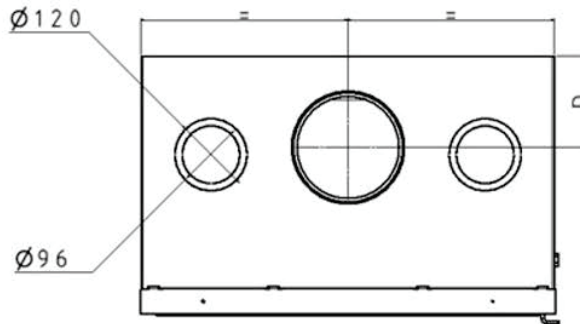
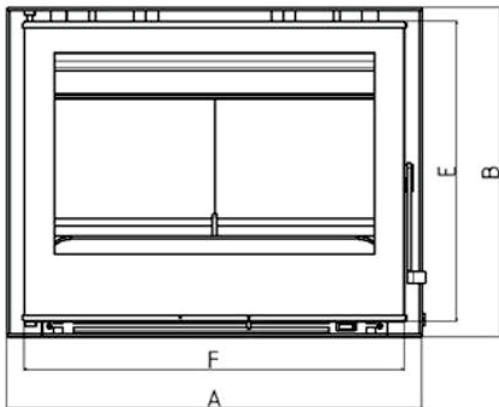

*Unit of measure and model dimensions may vary. E&OE.