



Available colours

* Selected colours are available on request only; Please confirm stock availability.



Output range Kw	14.3-15.5
Eco Design 2022 / Nom. Kw	14.6
Heating Capacity m³	357
Nominal Efficiency %	76
Type	Freestanding
Fuel Type	Wood
Max load / Nom. Cons. Kg/h	4.3
Brand	Bronpi
Category	Traditional Wood
Flue ø	150
Flue exit	Top, Rear
WxDxH mm	728 x 460 x 764
Weight Kg	154
Hopper capacity Kg	-
Finish	Cast-Iron
Ash tray	Yes
Glass cleaning air flow	Yes
Convection type	Natural
Multifire System	-
Dual power system	-
Ductable	-
Power settings	-
Remote control	-
Energy saving mode	-
Humidifier	-
Warranty	5 Yr. Structural Steel 7 Yr. Structural C-Iron 2 Yr. Elec. & Mech.

* All warranties are subject to CRMS registration.

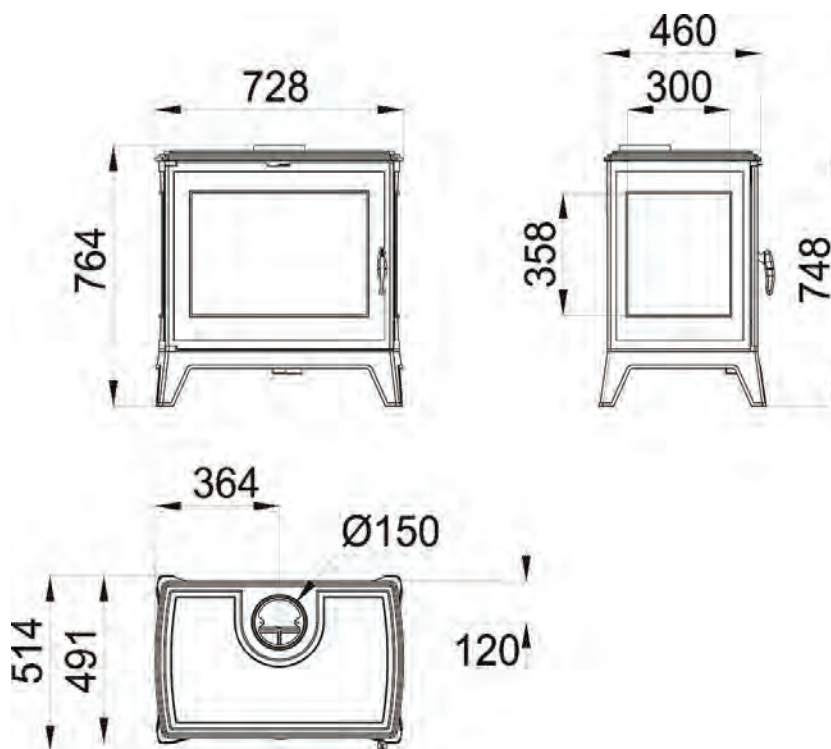

*Unit of measure and model dimensions may vary. E&OE.