

## SAFETY PRECAUTION:

### IMPORTANT: PLEASE READ BEFORE INSTALLATION:

- Before you begin installing the fan, shut power off at the circuit breaker of the fuse box.
- CAUTION:** Read all instructions and safety information before installing your new fan. Review accompanying assembly diagrams.
- Make sure that all electrical connections are in accordance with National Electrical Code, ANSI/NFPA 70 and local codes. Hire a licensed electrician if you are unfamiliar with installing electrical wiring.
- Make sure the installation site you choose allows the fan blades to rotate without any obstructions. Allow a minimum clearance of 2.1m (7 feet) from the floor and 18 inches from the tip of the blades to the wall.
- WARNING:** To reduce the risk of fire, electric shock, or personal injury, mount to outlet box marked "Acceptable for Fan Support of 15.9 kg (35 lbs) or less" and use mounting screws provided with the outlet box.
- CAUTION:** To reduce the risk of injury, use only the screws provided with the outlet box in conjunction with the lock washers provided with the fan.
- The outlet box and support structure must be securely mounted and capable of reliably supporting a minimum of 35 pounds. Use only U.L. listed outlet boxes marked "Acceptable for Fan Support of 15.9 kg (35 lbs) or less".
- After you install the fan, make sure that all mounting components are secured to prevent the fan from falling.
- Do not insert anything into the fan blades while the fan is operating.
- To change the direction of the rotation of the blades the fan must be in operation mode.
- All set screws must be checked and retightened where necessary before installation.
- WARNING:** To reduce the risk of personal injury, do not bend the blade bracket when installing the brackets, balancing the blades, or cleaning the fan. Do not insert foreign objects in between rotating fan blades.
- CAUTION:** To reduce the risk of electric shock, disconnect the electrical supply circuit to the fan before installing light kit.
- After making the wire connections, the wires should be spread apart with the grounded conductor and the equipment-grounding conductor on one side of the outlet box and the ungrounded conductor on the other side of the outlet box.
- The splices after being made should be turned upward and pushed carefully up into the outlet box. Conductor wiring identified as grounded is to be connected to a grounded conductor of power supply. Conductor wiring identified as ungrounded conductor is to be connected to an ungrounded conductor. Conductor wiring identified for equipment grounding is to be connected to an equipment-grounding conductor.
- This device complies with part 15 of the FCC Rules. Operation is subject to the following two conditions: (1) This device may not cause harmful interference, and (2) this device must accept any interference received, including interference that may cause undesired operation.  
**WARNING:** To reduce the risk of fire or electric shock, this fan must be installed with a general use, isolating wall control/switch.  
**WARNING:** To reduce the risk of fire or electric shock, do not use this fan with any solid-state speed control device.  
**NOTE:** The important safeguards and instructions appearing in this manual are not meant to cover all possible conditions and situations that may occur. It must be understood that common sense, caution and care are factors which cannot be built into this product. These factors must be supplied by the person (s) installing, caring for and operating the unit.
- This product is suitable for use in damp locations.  
**CAUTION:** The light source is designed for this specific application and can overheat if serviced by untrained personnel. If any servicing is required, the product should be returned to an authorized service facility for examination or repair.

### BEFORE YOU START

Contact a licensed electrician if you are uncomfortable performing electrical work. A licensed electrician must install the fan if required by local code. Do not use the fan with a dimmer switch. Turn off power at breaker.

### Product instruction:

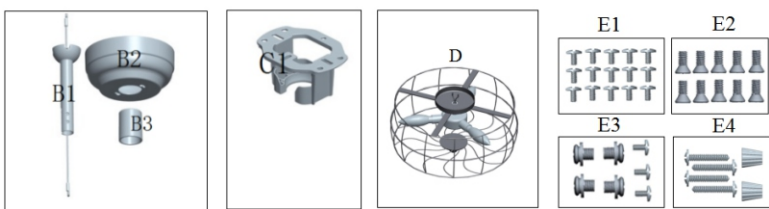
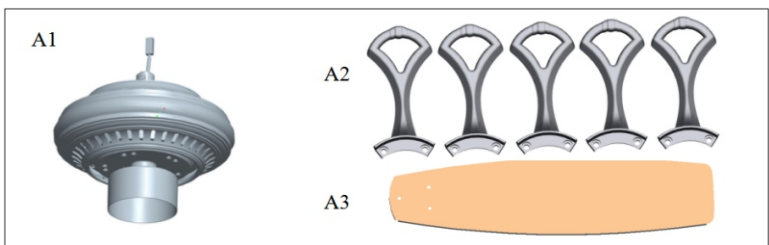
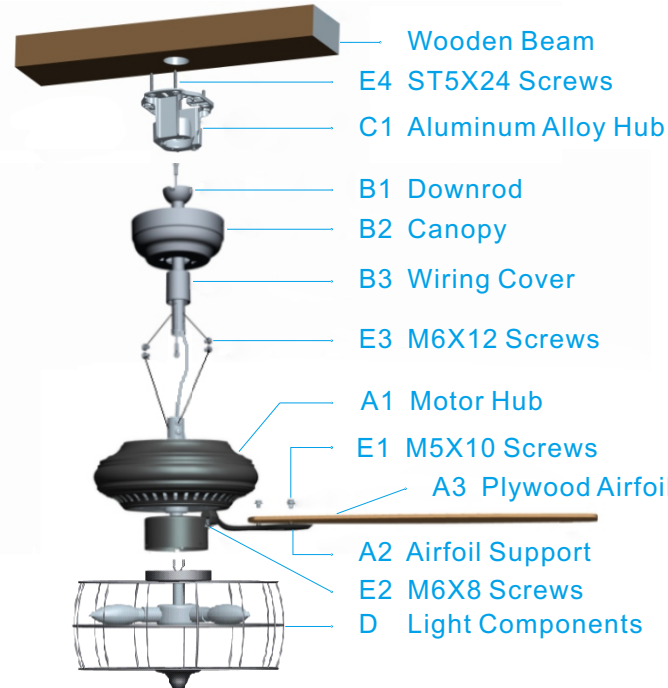

### Tools and Materials Required



### Installation:

#### 1. Install Airfoils:

As shown in the Fig 1.1, take the Aluminum Alloy Airfoil Support A2, the Plywood Airfoils A3, and the M5X10 Screws E1 for installation and connection. Fig 1.2 shows the schematic diagram of the airfoil support and fan blade after installation.

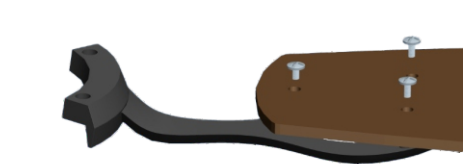

Fig 1.1

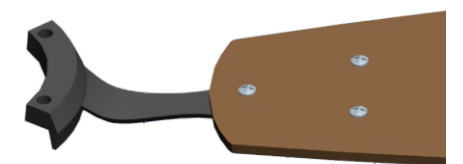

Fig 1.2

#### 2. Install airfoil support:

Take out the fan blades, use M6x8 screws to fasten the fan airfoil support with blade to the motor hub as shown in Fig 2.1. Install five fan blades, as shown in Fig 2.2 below.



Fig 2.1

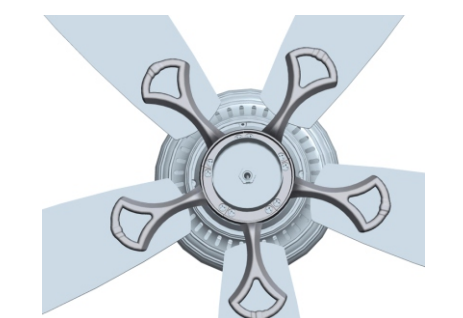

Fig 2.2

#### 3. Install Downrod:

Assemble downrod as pictured in Fig 3.1. Insert the downrod through the canopy and wiring cover. (Please select the suitable length of rod for your ceiling.)  
**Note:** If you choose to install a safety cable/chain onto your ceiling fan, you will also need to run it through the downrod prior to installation.



Fig 3.1



Fig 3.2

#### 4. Install the Downrod and Canopy:

Pass the power cord of the motor assembly through the downrod as shown in Fig 4.1.  
**Note:** Take out the end of the safety cable from the downrod before sliding the downrod into the plastic head of the motor assembly. Align the holes, secure with screws and washers in opposite directions from each other (2 sets on each side) and make sure the screws and washers are tightened firmly with a screwdriver. Remove the screw already set inside of the motor shaft, then secure the safety cable into the motor shaft firmly by this screw. (See Fig 4.2 & 4.3)  
Slide the wiring cover down until it rests on top of the motor assembly. (See Fig 4.4)

Fig 4.1

Fig 4.2

Fig 4.3

Fig 4.4

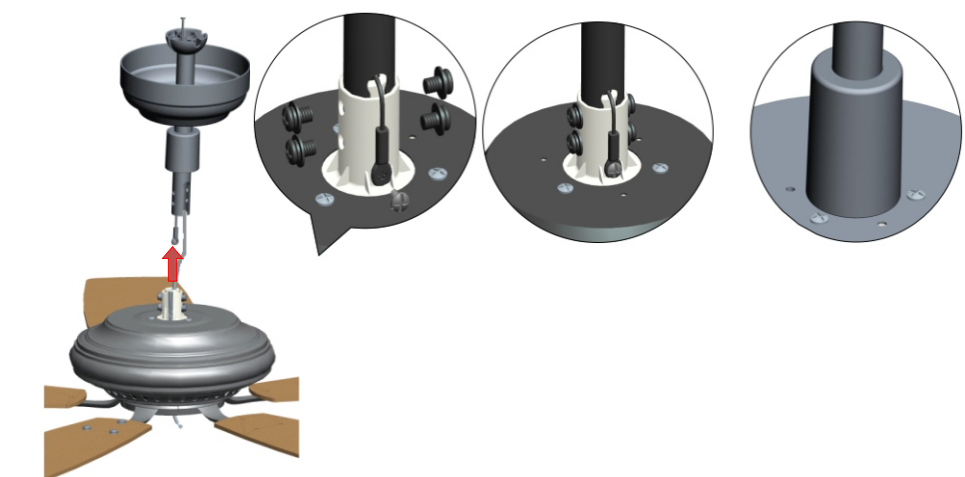

#### 5. Install the Mounting Bracket:

Install the mounting bracket to the ceiling box, as shown in Fig 5.1 below. Rotate the mounting bracket in different directions so that the bracket mounting holes match the screw holes of the ceiling box.  
**Note:** This mounting bracket is a standard cable box. If the mounting bracket is installed at the outlet box, it should be installed on the outlet box with two screws matching the outlet box itself, as shown in Fig 5.1. This bracket can also be mounted to the wooden ceiling beam, and then the four ST5x24 screws can be used to lock the corresponding holes on the left and right sides of the bracket.  
**Note:** The wooden ceiling beam must meet the tensile test of 30KG for installation, as shown in Fig 5.2. It is also possible to install the mounting bracket directly to the concrete ceiling and install four screws to the left and right corresponding holes of the bracket to lock the ceiling.

#### If you have an angled or vaulted ceiling: (Fig 5.3)

- When installing the mounting bracket, the bracket groove is upward.
- You will need a longer downrod.
- If your ceiling angle is greater than 25°, you will also need an Angled Mounting Kit.

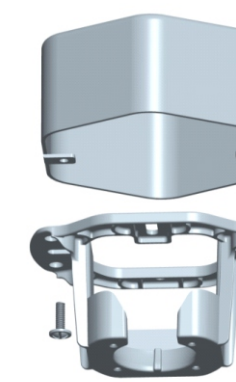

Fig 5.1



Fig 5.2

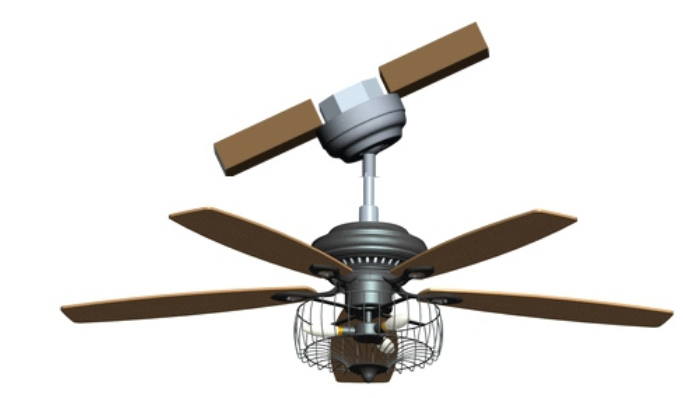

Fig 5.3

#### 6. Hanging Ceiling Fan & Installing Power Adapter & Wiring the Fan:

**WARNING:** To reduce the risk of fire, electric shock or other personal injury, mount the fan only to an outlet box or supporting system marked acceptable for fan support and use the mounting screws provided with the outlet box.  
**WARNING:** Check to see that all connections are tight, including ground, and there are no visible bare wires at the wire nuts (except for the ground wire).  
**WARNING:** To reduce the risk of fire or electric shock, do not use this fan with any solid-state speed control device.  
**WARNING:** To avoid any electrical shock, be sure electricity is turned off at the main fuse box before wiring.

6.1 Hang the assembled ceiling fan on the mounting bracket that mounted to the ceiling as shown in Fig 6.1, pay attention to the enlarged image as shown in Fig 6.1. Install the ball end of the downrod into the opening of mounting bracket. Rotate the downrod until the tab in the mounting bracket is seated in the slot in the downrod ball.  
6.2 Fasten the safety rope to a safe place. The white wire from the motor hub corresponds to the neutral wire from supply power, and the black wire corresponds to the live wire from supply power. Use the wire caps to tuck the wires together accordingly. The Yellow/Green wire is ground wire and needs to be connected accordingly. (Make sure all the wires are connected to the correct colors as shown in Fig 6.2.)

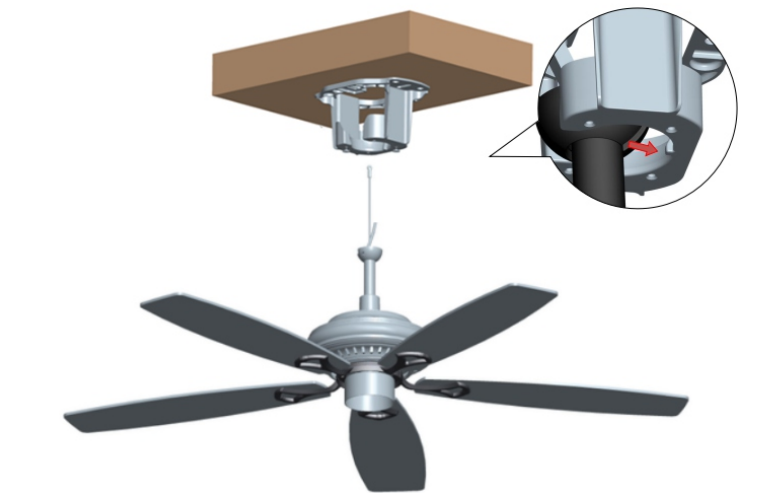

Fig 6.1

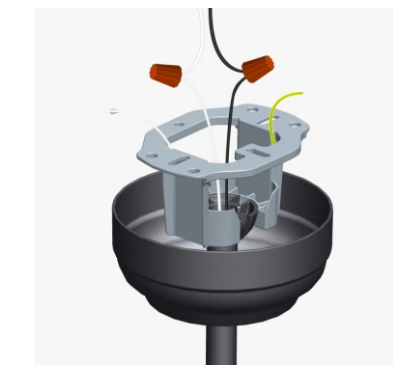

Fig 6.2

#### 7. Raise Canopy:

There are two kinds of canopies and two ways to install. You may receive one of them. Please follow below instructions before installation.

#### A: The screws of mounting bracket are exposed:

Make sure all wires are tucked in the canopy. Raise the canopy to the mounting bracket, align the hole slots in the canopy with the two mounting bracket screws, then turn the canopy in the direction of the arrow in Fig A until the mounting brackets screws engage from the bigger slots of the canopy to the smaller ones. Then secure the canopy to the mounting bracket with the screws.

#### B: The screws of mounting bracket are not exposed:

Make sure all wires are tucked in the canopy. Raise the canopy to the mounting bracket, align the two screws into the slot inside the canopy, rotate and twist the canopy to lock into place according to the direction symbol/arrow.



(A)

(B)

#### 8. Connect the Chandelier components:

As shown in Fig 8.1, first connect the Lamp Wire terminals, and then use M4x6 screws to fix it. As shown in Fig 8.2, the Lampshade is installed.



Fig 8.1



Fig 8.2

**Power on:**

The Fig 9.1 below is a schematic diagram of the whole machine after installation. At this time, the ceiling fan has been installed. Turn on the power supply of the main switch or the room where the ceiling fan is installed. After power on, observe whether the fan light is on.

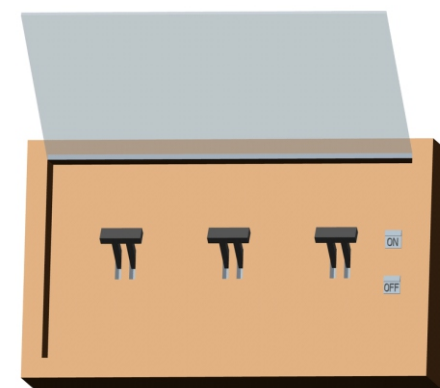



Fig 9.1

**Remote Control Operating Instructions:**

**Pairing the Remote Control to Your Fan**

Within 10 min. of plugging fan to power source, press and hold  button for 5 sec. to pair remote control and fan. Successful pairing will trigger the fan lamp off.

**Remote Control button definitions**

 OFF Press this button and stop the fan from rotation.

 F/R Switch between summer mode and winter mode.

• Summer mode - (Counter-clockwise) A downward airflow creates a cooling effect.  
• Winter model - (Clockwise)  
An upward airflow moves warm air away from the ceiling area and redistributes it around the living space.

 Turn the fan on and decreases fan speed.

 Turn the fan on and Increases fan speed.

 Turn on or off the fan and the fan light.

**Note:** Press/hold button for 5 sec. within 10 min. of plugging fan to power source to pair remote and fan. Successful pairing will trigger the fan lamp off.

 When the fan is on,press this button and the fan will be shut down 1 hour later.

 When the fan is on,press this button and the fan will be shut down 2 hours later.

 When the fan is on,press this button and the fan will be shut down 4 hours later.

 When the fan is on,press this button and the fan will be shut down 8 hours later.

 Turn on or off the fan light.

**Warning: Do not expose the remote control to direct contact of water.**

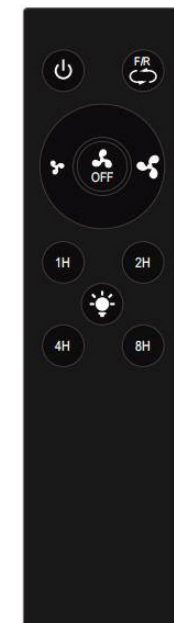

**Basic product parameters:**

Model	ADC525DL2	Voltage	120V
Fan Blade Span	52"	Rated Wattage	97W(Fan 22W Lamp 75W)
Gross weight	16.1lbs.	Rpm	66-200rpm
Maximum Airflow	4490CFM	Maximum Noise	55dB(A)

Model	ADC565DL2	Voltage	120V
Fan Blade Span	56"	Rated Wattage	109W(Fan 34W Lamp 75W)
Gross weight	16.1lbs.	Rpm	66-185rpm
Maximum Airflow	5087CFM	Maximum Noise	55dB(A)

**Care and cleaning:**

1. Check the support connections, brackets, and airfoil attachments twice a year. Make sure they are secure. Because of the fan's natural movement, some connections may become loose over time. It is not necessary to remove the fan from the ceiling.
2. Clean your fan periodically. Use only a soft brush or lint-free cloth to avoid scratching the finish. The plating is sealed with a lacquer to minimize discoloration or tarnishing.
3. (Optional) Apply a light coat of furniture polish to the wood blades.
4. (Optional) Cover small scratches with a light application of shoe polish.

**Do not:**

1. Use water when cleaning. Water could damage the motor, or the wood, or possibly cause an electrical shock.
  2. Apply oil to your fan or motor. The motor has permanently lubricated sealed ball bearings.
- Note:Power off the fan before product maintenance or cleaning the fan.**

**FCC Statement:**

**NOTE:**This equipment has been tested and found to comply with the limits for a Class B digital device, pursuant to part 15 of the FCC Rules, These limits are designed to provide reasonable protection against harmful interference in a residential installation. This equipment generates, uses and can radiate radio frequency energy and, if not installed and used in accordance with the instructions, may cause harmful interference to radio communications. However, there is no guarantee that interference will not occur in a particular installation. If this equipment does cause harmful interference to radio or television reception, which can be determined by turning the equipment off and on, the user is encouraged to try to correct the interference by one or more of the following measures:

- Reorient or relocate the receiving antenna.
- Increase the separation between the equipment and receiver.
- Connect the equipment into an outlet on a circuit different from that to which the receiver is connected.
- Consult the dealer or an experienced radio/TV technician for help.

**WARNING:** Changes or modifications to this unit not expressly approved by the party responsible for compliance could void the user's authority to operate the equipment.

**Troubleshooting:**

Try these troubleshooting steps before contacting the Customer Service. For additional operation, maintenance, and troubleshooting information, please contact our customer service center.

SYMPTOM	POSSIBLE SOLUTION
Fan not spinning	<ol style="list-style-type: none"> <li>1. Make sure the fan is getting power.</li> <li>2. Check your circuit breaker or fuse panel and wall switch for functionality.</li> <li>3. Fan wires are connecting with the house wires correctly.</li> <li>4. Remote control must be paired with the fan within 10 minutes after the fan getting power</li> <li>5. Use a multi-meter and test the adapter wiring harness to see if there is any electrical output.</li> <li>6. All the pin wiring on the circuit board are inserted tight and in the right position.</li> <li>7. Remote need to pair with the fan first.</li> <li>8. Make sure the fan blades spin freely.</li> <li>9. If you're using a wall control, check the power to the breaker from your control and try working your ceiling fan manually. (Normal switch only for the fan power on/off)</li> </ol>
Fan light not working	<ol style="list-style-type: none"> <li>1. Make sure LED light kit/light bulb connected well.</li> <li>2. Make sure the whole fan is powered.</li> <li>3. Remote need to pair with the fan first,correctly and in the retention slot.</li> </ol>
The fan is noisy and wobbling	<ol style="list-style-type: none"> <li>1. Check if the blade screws are NOT rubbing against the round plastic part of the motor.</li> <li>2. Check the pin wire are NOT connected against the moving part.</li> <li>3. Check the down fan cup is NOT hitting the motor.</li> <li>4. Confirm the canopy is NOT touching the ceiling while the fan is in operation.</li> <li>5. Check the down rod is NOT slanted.</li> <li>6. Tighten any loose screws on the light kit, fan blades, motor coupling, down rod, brackets and mounting hardware.</li> <li>7. Confirm the hanger ball is firmly seated in the mounting bracket.</li> <li>8. The ceiling beam must meet the minimum tensile test strength of 30KG for installation.</li> <li>9. Make sure the airfoils and brackets are NOT bent or deformed.</li> <li>10. Verify the wire connections are not rattling against each other.</li> <li>11. Verify the fan blades are not cracked. If the fan blades are cracked, replace the damaged blades with a new blade set from the same brand as your ceiling fan to ensure compatibility.</li> <li>12. The light kit is NOT slanting and hitting the motor.</li> </ol>
Unable to pair remote	<ol style="list-style-type: none"> <li>1. Check if the wires are connected in the right position or not.</li> <li>2. Check the batteries in the remote.</li> <li>3. Disconnect the power for 10 minutes, reconnect the power and pair the remote with the fan immediately.</li> </ol>
Fan or light turning on or off by themselves	<ol style="list-style-type: none"> <li>1. Confirm the circuit breaker is not malfunctioning.</li> <li>2. Verify the wire connections are not frayed.</li> <li>3. Cut the fan power for 10 minutes then power on again.</li> <li>4. All the pins wiring on the circuit board are inserted tight and in the right position.</li> </ol>

Carro USA Inc.  
1431 S. Baker Ave., Ontario CA 91761  
Tel: 888-253-2374  
www.carrohome.com | cs@carrohome.com



ITEM: ADC525DL2/ADC565DL2  
Technical Parameter: AC 120V 60Hz

**CEILING FAN INSTALLATION GUIDE**  
Please read and follow all the Instructions carefully before using this product  
The product image shown here is indicative only.  
Actual product you receive may differ.