

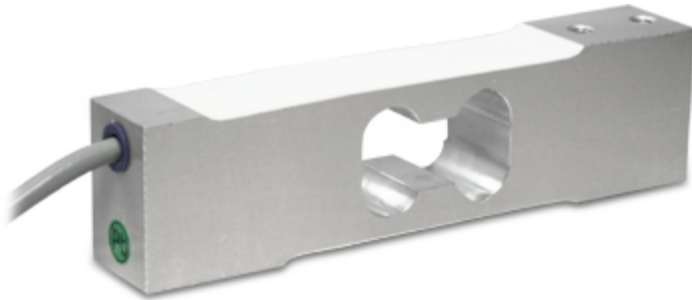

SPG

SPG SERIES SINGLE POINT LOAD CELLS, C3 CLASS



Load cells for off center loads, suitable for example to build CE-M approved scales with a single load cell; maximum platform dimensions of 600x600 mm.

CAPACITIES (kg): 10, 15, 20, 30, 50, 100, 200.

OIML R60. C3 precision class.

Aluminium alloy. IP67 protection.

The best solution
for advanced industrial
applications

MAIN FEATURES

- C3 PRECISION CLASS
- OFF CENTER LOAD COMPENSATED
- ALUMINIUM ALLOY CONSTRUCTION
- IP67 PROTECTION
- MAX. CAPACITIES FROM 10 TO 200 kg
- FOR PLATFORMS WITH DIMENSIONS UP TO 600 X 600 mm
- SHIELDED CONNECTION CABLE
- OIML CERTIFICATE AVAILABLE UPON REQUEST
- TEST CERTIFICATE AVAILABLE UPON REQUEST

TECHNICAL FEATURES

- Minimum load cell verification interval: $V_{min} = E_{Max} / 15.000$
- Maximum number of verification intervals: $n_{LC} = 3000$
- Sensitivity: $2mV/V \pm 10\%$
- Combined error: 0,03% of Full Span (F.S.)
- Temperature effect on zero: 0,01% FS/10K
- Temperature effect on Full Span: 0,001% FS/10K
- Compensated Temperature Range: $-10^{\circ}C/+40^{\circ}C$
- Operating Temperature Range: $-10^{\circ}C/+50^{\circ}C$
- Creep at nominal load in 30 minutes: 0,01% F.S.
- Maximum excitation voltage without damage: 15 Vdc
- Input Resistance: 300..500 Ohm
- Output Resistance: 300..500 Ohm
- Zero Balance: $0 \pm 0,1\%$ F.S.
- Insulation Resistance: >2000 MOhm
- Mechanical limit load in service: 150% F.S.
- Destructive load: 300% F.S.
- Deflection at nominal load $<0,3mm$
- 6-wire shielded cable, 3m long, 4,7mm diameter

ATEX Version

- The CCATEX certificate makes the load cell suitable for use in hazardous areas with protection methods according to:
ATEX II 1G Ex ia IIC T6 (Ta $-20^{\circ}C/+40^{\circ}C$) TX (Ta $-20^{\circ}C/+65^{\circ}C$) Ga
ATEX II 1D Ex ta IIIC TX $^{\circ}C$ (Ta $-20^{\circ}C/+40^{\circ}C$) TX $^{\circ}C$ (Ta $-20^{\circ}C/+65^{\circ}C$) Da IP65.
The certificate includes the manual and the ATEX CE conformity declaration (available in EN, DE, FR, and IT).
- **IMPORTANT:** the certificate refers to the single load cell. For systems with more load cells, it is necessary to order one certificate for each load cell.

DETAIL 1

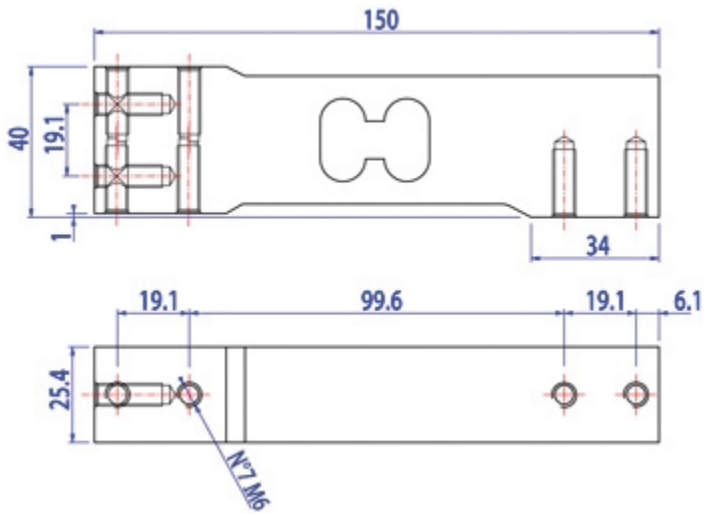







Dimensions (mm)

Wiring Code	
<i>Colour</i>	<i>Function</i>
YELLOW	SHIELD
WHITE	OUTPUT +
GREEN	SENSE +
BLUE	INPUT +
RED	OUTPUT -
GREY	SENSE -
BLACK	INPUT -

VERSIONS

Versioni disponibili

Codice	Piatto Max (mm)	Max (kg)
SPG10 	300x300	10
SPG15 	400x400	15
SPG20 	450x450	20
SPG30 	450x450	30
SPG50 	600x600	50
SPG100 	600x600	100
SPG200 	600x600	200



GRAVITATION LTD.

UNIT 2B SECTION 5 DUNSHAUGHLIN - - CO. MEATH - IRELAND

Tel. 00353469078900

Fax. 00353469078911

E-mail info@gravitation.ie

Web www.gravitation.ie

All the specifications and images can be subject to variations and upgrades without prior notice.