

565/4R moltiplicatore di coppia rapporto 25:1 con dispositivo antiritorno

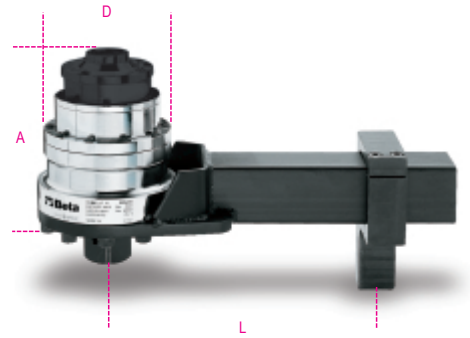

	 005650014	art. 565/4R
--	--	-----------------------