

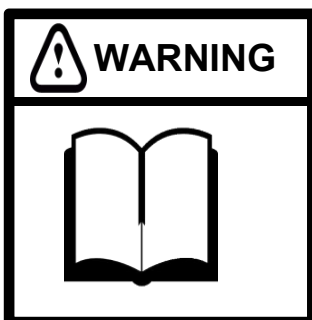

## AGT-DY14 Excavator 14-Paragon With Thumb Clamp



- Please read the product manual completely before assembly
- Check against the parts list to make sure all parts are received
- Wear proper safety goggles or other protective gears while in assembly

Missing parts or questions on assembly?

Please contact [sales@agrotkindustrial.com](mailto:sales@agrotkindustrial.com)

<https://www.agrotkindustrial.com/>

# Preface

Dear users:

Thank you for your trust and love for our products !

The mini-excavator manufactured by the Company is a small excavator which is mainly used for the excavation operation, hoisting as well as loading and unloading. The mini-excavator has compact design structure, proper power, good product stability and high-cost performance, and meets the requirements of excavation, loading and unloading under different operating conditions such as plains, hills and forest areas. The mini-excavator is suitable for use in brick and tile factories, kiln factories, river courses, buildings, as well as desilting and road construction, which is the most ideal construction mini-excavator for farmland operation and small projects.

This manual is a operating manual prepared for the safe and efficient operation of the machine.

Before operating this machine, always read this manual and fully understand the operation, inspection and maintenance until you have full knowledge.

All data, charts and technical specifications in this manual use the latest product data available when this manual is published. The Company reserves the right to change at any time without further notice.

If accidentally operating the machine, it will result in serious injury or death.

Operators and maintenance personnel should carefully read this manual and fully understand its contents before performing the operation or maintenance of the machine.

For easy access, keep this manual properly for regular reading by qualified machine operators.

Please operate the machine after fully understanding the contents of this manual.

Please keep this manual within reach and read it repeatedly.

If this manual is lost or damaged, please order it immediately from us or our agents.

When transferring this machine, please transfer this manual together to facilitate the proper use of the next owner.

For safety, please be sure to read the "safety-related precautions" described in this book.

## **Manufacturer's requirements**

### **Pledge**

The quality assurance scope of this machine shall be subject to the quality warranty provided by the manufacturer. Where the failure of the machine is the responsibility of the manufacturer.

For example, loss of normal function and operation failure, repaired by the manufacturer free of charge. The Department is not responsible for the loss of normal function and machine failure due to user negligence or failure to follow the instructions of this manual.

If the user considers a problem in the service, please contact the company after sale.

## **User attention**

If the contents of this manual do not consistent with the machine you use or have any other questions, please contact your company immediately after sale.

## **Security related information**

Most of the accidents related to operation operations, inspection, maintenance, and repair operations are caused by basic negligent safety precautions and hazard forecasts.

Accidents can be prevented in the bud by predicting dangerous conditions. Therefore, attention must be paid to the location and type of danger. (To properly perform such operations, you must have the specified training, techniques, and tools. )

Improper operation operation and improper inspection and maintenance operations are very dangerous and will lead to personal injury accidents.

Please carefully read all the safety precautions, warnings and accident precautions documented in this manual and machine and understand the contents until fully mastered, otherwise absolutely not Ability of machine operation and inspection and maintenance operations. If these warnings will cause personal casualties, be attention.

The safety tips of this manual, the safety signs used on this machine, distinguish the extent of the possible hazards by the following warnings. Also includes

Prevention methods to avoid danger.

The Company cannot predict all hazards of operation, inspection and maintenance in all environments. Therefore, the warnings indicated on this manual and this machine do not cover all cases. If the operation, inspection and maintenance are not involved in this manual, please consider the necessary safety precautions by themselves. Users are personally responsible to take the necessary safety measures.

Safety Regarding proper maintenance and maintenance of the machine. The recommendations are printed in the relevant sections of operation and maintenance in this manual. Poor maintenance or maintenance steps are dangerous and can lead to injury or death. Read and understand sections of operation and repair before any maintenance or repair.

Maintenance personnel or technicians may not be familiar with many systems of the machine, so special attention when performing services. When loading and unloading any part.

It is important to have the knowledge of the system and components.

Many machines have parts size or weight, maintenance personnel or mechanics can find information in this manual, and suitable cranes should be used when removing any parts.

With.

The following are the basic things to note:

1. All warnings, notices, and signs shall be read before operation, maintenance, or repair.

2. Wear goggles and feet when working around any part of the machine or any accessory parts such as a crusher or a heavy hammer shoes. For welding work, wear welding gloves, head covers, apron guards and other protective overalls as

appropriate. Don't wear it loose or broken damaged clothes. Remove all of the rings while working off the machine.

3. Remove the battery negative line and hang the "Do not operate" sign in front of the cab before repairing the machine.

4. When repairing the machine, park the machine as hard as possible and fix the machine so that it is working above or below the machine will not slide.

<p><b>Do not operate the machine until you read and understand this manual. Because the incorrect operation of the machine is dangerous and can result in injury or death.</b></p>
--

5. During any decomposition, the machine does not work if it is simply suspended. The machine must be stably supported or fixed before being on the machine work.

6. Release the pressure (e. g., air, oil, cooling water system, etc.) before removing any line, plug, or related components.

7. Before doing any work on the machine, drop the ground. If some components cannot fall to the ground, determine whether they are properly fixed to avoid accidental falls.

8. Use the steps, railings, and walkways when going up and down the machine. To remove the above debris before use, and face the step stairs and walkway. If the designed auxiliary equipment cannot be used, please prepare an additional ladder, eagle frame or work platform for safe repair or operation

9. To avoid waist injury, use a sling for heavy parts of over 23 kg (50lbs). And determine whether all the chains, hooks, etc., are in the normal use state.

10. Pay attention to the hot part of the machine to avoid burns.

11. Be careful when removing the cover plate. Gradually remove the last two bolts or caps, pay attention to the spring or other pressure components before complete removal.

12. Use special care when opening the water tank cap, oil cap, and other plugs. For example, avoid a liquid with pressure pouring out, because this condition is quite dangerous.

13. The tools should be kept in good condition. Know the tools for any work.

14. Reinstall the fixed clip with the same part number, and do not use secondary products if it must be replaced.

15. Appropriate reference materials shall be provided for welding and repair. Welding technicians shall have sufficient training and relevant knowledge.

16. Do not damage the wire when removing, and take careful not to damage the wire when reinstalling. Be careful not to touch the liquid when connecting the wire.

17. Before starting the repair, determine that all protective covers and other devices have been properly installed. Double down if the protection device must be removed during repair pay attention to.

18. During maintenance or repair, hold the arms, and place them on the ground.

19. Relax or damaged fuel pipes, oil pipes and hydraulic pipes are dangerous. So you should wear work clothes at work, but do not wear loose or damaged clothes service, because the hydraulic oil pipe may cause a fire. Do not fold or tap the high pressure pipe, damaged pipe do not use again. Please do not measure the leak by hand. Because the very small pinhole can not be seen by the naked eye, and it may be injured by emitting high-pressure liquid at high speed. Use sheets of paper or splints to find out the location of the pinhole.

20. Each oil pipe joint shall be tightened with the correct torque wrench. Determine that all heat insulation plates, clamclips and covers are in safe condition. Avoid overheating, vibration, or friction with other components during operation.

21. If any rotating part is damaged or interfered with any other part, the machine operation must be stopped.

22. Special attention should be paid to crawler machines during repair or decomposition. Because plug pins or debris may fly out during loading and unloading. When the machine sprocket of the machine is removed, the machine may move unexpectedly. So place barriers to prevent the machine from moving and moving away from the front and rear of the machine.

23. Special care should be taken when there are asbestos fibres on the parts. This dust will cause harm to the body if inhaled. If asbestos fibers are found in components, the following points must be noted:

- a. Do not use compressed air cleaning components
- b. Avoid brushing grindstone cotton fiber materials
- c. Use wet cleaning or vacuum equipment with a hePA screen when cleaning
- d. Use exhaust fan when working for a long time
- e. Wear protective mask if there is no other way to control dust
- f. Comply with workplace rules
- g. Dispose of asbestos fibre waste in accordance with environmental regulations
- h. Avoid asbestos-prone areas, especially when filled with air

## Table of Contents

Safety precautions.....	1
Precautions before preparation and during start-up.....	6
Schematic diagram for safety signs:.....	8
Precautions during operation.....	14
Traction precautions:.....	20
Hydraulic breaking hammer.....	22
Precautions when stopping:.....	24
Precautions during transportation:.....	25
Maintenance precautions.....	27
Regular inspection and maintenance:.....	29
Waste disposal:.....	33

## Safety precautions

It is your responsibility to comply with the safety regulations and laws of relevant departments, and to operate, inspect and maintain the mini-excavator as required by the manufacturer.

In fact, all accidents are caused by non-compliance with basic safety regulations and precautions. Most accidents can be avoided by identifying potential hazardous situations in advance.

Please read and understand all safety information on how to prevent accidents. Do not operate the mini-excavator until you are sure that you know how to operate, inspect and maintain the mini-excavator correctly.

Compliance with all safety regulations: the mini-excavator must be operated, inspected and maintained by trained and qualified personnel; All rules, regulations, precautions and safety measures must be understood and observed during operation, inspection and maintenance of the mini-excavator; Do not operate, inspect or maintain the mini-excavator if the operator is under the influence of alcohol, medicines, drugs, fatigue or lack of sleep.

When the mini-excavator is in an abnormal status: in the process of operation or inspection and maintenance of the mini-excavator, if the mini-excavator is found to be in an abnormal status (there are noise, vibration, peculiar smell, oil leakage, and false alarm, etc.), the operation should be stopped immediately and the mini-excavator should be shut down. Do not operate the mini-excavator until exceptions are removed.

Operating temperature: in order to maintain the performance of the mini-excavator and avoid premature wear, please observe the following operating conditions: If the outdoor temperature exceeds  $+ 45^{\circ} \text{C}$  or is lower than  $- 15^{\circ} \text{C}$ , do not operate the mini-excavator; If the outdoor temperature exceeds  $+ 45^{\circ} \text{C}$ , the engine may overheat, resulting in the degradation of engine oil performance. Moreover, the hydraulic oil may become very hot and cause damage to the hydraulic equipment; If operating at an outdoor temperature below  $- 15^{\circ} \text{C}$ , rubber parts such as gaskets may harden, resulting in premature wear or damage of the mini-excavator; If the mini-excavator is operated beyond the above outdoor temperature, please consult the sales or after-sales service personnel. Please wear appropriate clothes and protective equipment (as shown in the figure).



Do not wear loose clothing or decorations that may be hung on the control lever. Avoid collision with the operating handle, thus resulting in operation and collision with mini-excavator.

Wear safety shoes, helmets, safety glasses, filter masks, gloves, ear protection and other protective equipment according to the requirements of the working environment.

Before the mini-excavator is operated, please go around it and check whether there are people or obstacles around it.

Installation of fire extinguisher

Do a good job in fire and accident handling, and correctly use fire extinguishers.

Do not remove safety devices: please make sure that all protective barriers, etc. are installed in place and secure.

**Before the mini-excavator is operated, please check whether the safety device is secure.**



When the excavation operation is completed or the operation of the mini-excavator is stopped, the bucket of the mini-excavator should be lowered to the ground and the key should be removed.



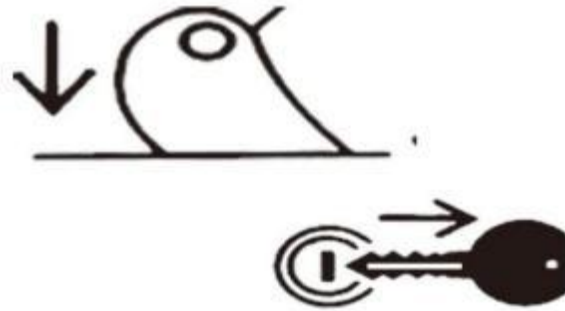

### Arrangement of signalman and flagman



Learn how to use the gestures required in a specific job and identify the person who are responsible for making gestures.

All person must fully understand all gestures.

The operator must only make a respond to the gesture of the designated person, but must obey the shutdown gesture issued by anyone at any time.

The signalman must stand in a clear and visible place at the time of sending a signal.

## Avoidance of fire and explosion hazards



Do not smoke or have open flames when operation the mini-excavator with fuel or fuel systems. Do not carry fire sources, inflammable and explosive articles.

Do not leave the operation site when replenishing fuel or lubricating oil to the mini-excavator. Do not remove the fuel tank cap or add fuel when the engine is running or has not cooled down. In addition, do not splash fuel on hot surfaces or electronic system components of the mini-excavator.

Before the mini-excavator is operated, if there is oil stains on the surface of the mini-excavator, please check the mini-excavator for oil leakage. After confirming that there is no oil leakage, wipe it clean and then start the mini-excavator.

Remove all garbage or sundries in the mini-excavator and ensure that no greasy rags or other inflammables are placed on the mini-excavator.

Handle all kinds of solvents or dry chemicals (foam extinguishers) in a well-ventilated area according to the procedures marked on the manufacturer's containers.

Do not use fuel for cleaning purposes, always use nonflammable solvents.

Keep all flammable liquids and materials in a safe and well ventilated place.

If the electronic system is short circuited, it may cause a fire. Regularly check whether the wires in the electronic system are loose or damaged. Re-tighten the loose connectors and cable clips. Repair or replace damaged wires.

Pipeline and oil circuit: regularly check the pipeline and oil circuit. Ensure that the clamps, protective devices and buffer pads of hoses and pipes are firmly fixed. If

there is looseness, the hose or pipe will be damaged due to vibration or contact with other parts during operation. This may cause high-pressure oil to be sprayed out, thus causing fire or injury.

### Protection against harmful gases



Caution harmful gas poisoning

When working in poor ventilation or sealed environment, pay attention to wearing protective masks and adding exhaust devices.

When working in a dusty environment, you must wear a dust mask. Do not work in a dusty environment for a long time, which may cause damage to the body.

### Be careful of crushing

Do not place your hands, feet or other body parts in the middle of the caterpillar band of the mini-excavator. When the mini-excavator is started, it is strictly prohibited to stand other personnel within the operation radius and stack objects that hinder the operation of the mini-excavator. Avoid bumping and crushing damage.



## Precautions before preparation and during start-up

### Precautions for preparation before operation:

Understand the operation environment: before operation, understand the operation area to ensure operation safety.

Check the terrain and ground conditions in the operation area, check the building structure during indoor operation, and take safety measures if necessary. Remove dangerous objects and obstacles in ditches, underground pipelines, trees, cliffs, overhead power lines, falling rocks and landslides.



### Precautions during starting:

Before operating the mini-excavator, walk around the mini-excavator and make sure there are no other workers or obstructions within the rotation radius of the mini-excavator.

Climb up/down the foot pedal by means of facing the mini-excavator and hold the

handrail, support your weight in a three-point safe posture (hands and feet). Do not pull the control operation lever.

Check whether there are "do not operate it" warning signs or similar signs on the cab, brake or start switch. If such warning signs exist, please do not start the engine or touch any operating lever. Contact relevant personnel to confirm whether the mini-excavator can be used normally. After confirmation, please you fasten the safety belt. Honk the horn to warn people around the mini-excavator. Make sure that the operating lever is in the middle position before starting the mini-excavator.

After starting the engine, make sure that the mini-excavator is operated without personnel or obstacles. If any fault is found, shut down according to the program and report the fault.

- Preheat the starter and hydraulic oil.



Warning sign  
Before starting the  
mini-excavator,  
Please fasten your seat  
belt

- Check whether all instruments and alarm devices work normally.
- Check whether there is noise in the mini-excavator.
- Test the engine speed control.
- Operate the controls to ensure that they can work properly.

## Use in cold climates



Be careful of freezing in severe cold weather. The ground, pedal and handle are very slippery.

In severe cold weather, do not touch any metal part of the mini-excavator with bare hands. The skin will freeze on the metal and cause serious injury.

Do not use ethyl acetate or starting fluid on the engine. Starting fluid can cause explosion and serious injury or death.

Preheat engine and hydraulic fluid. In cold weather, after the mini-excavator is started, the engine should idle for 2 to 5 minutes. If the control lever is operated without warm-up, the mini-excavator will not react or move quickly or properly, which may cause accidents.

### Schematic diagram for safety signs:

1. Precautions for adjusting caterpillar band tension: this sign is located on both sides of caterpillar band beam.

The pressure in the oil cylinder of the belt tensioner is very high. Adjustment or disassembly of the belt tensioner must be carried out in accordance with the operator's manual. Incorrect operation may cause personal injury.

2. The grease filling sign is located on the key structure lubrication diagram:



3. Pay attention to warning signs such as precautions for diesel replacement, loading warning, movement and operation warning, high-voltage line, reading instructions, road lock and height warning signs. These signs are located on the oil seat cover.



4. Sign away from turning area:

This sign is located on the rear counterweight.

- ▲ No one is allowed to stand within the rotating area of the mini-excavator.
- ▲ Do not damage or remove the sign from the mini-excavator.

5. Fuel sign:

This sign is located at the fuel tank filler.

- ▲ Turn off the engine when filling fuel, and keep away from all open flames when filling fuel.
- ▲ Pay attention to view the precautions on the fuel label.
- ▲ Do not damage or remove the sign from the mini-excavator.

6. Precautions for use of battery:

This sign is located on the foot pedal above the battery (pay attention to watch this sign)

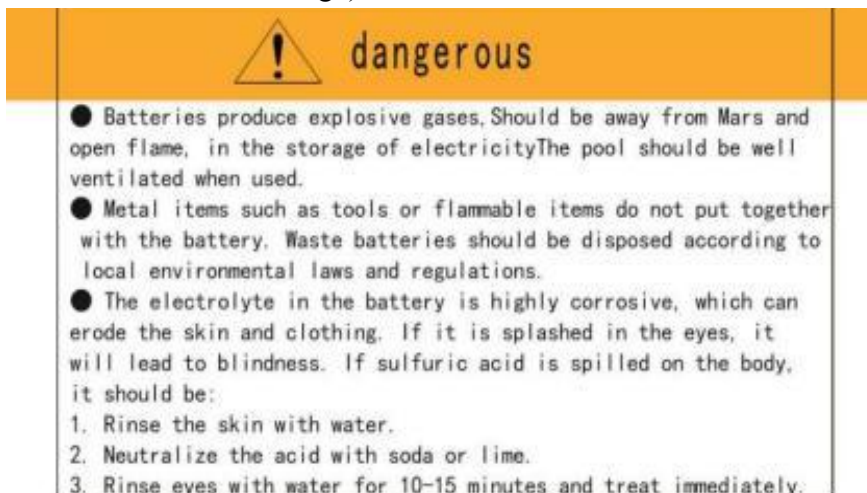

7. No one is allowed to stand in the operation area: this sign is located on both sides of the working arm.



8. Stay away from the excavation area: this sign is located on both sides of the bucket arm.







9. Hydraulic tank sign: this sign is located on the housing at the hydraulic oil tank.

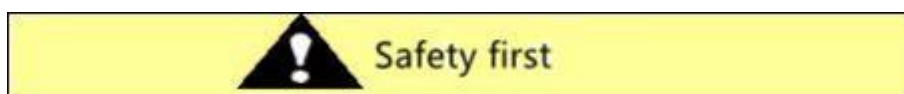

10. Danger sign for hydraulic oil tank : this sign is located on the tank cover plate.



The precautions recorded in this manual and the label with  symbol posted on the mini-excavator are important items that may lead to personal accidents. If the label with  symbol is dirty or falls off, you must purchase it from the local sales store and post it in the designated position.

## Sign on precautions

The operation manual determines the matters needing special attention when using the mini-excavator as follows:

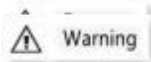

It means that failure to observe the precautions will result in death or serious injury.

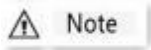

It means that failure to observe the precautions will result in death or serious injury.

It means there is a risk of injury if precautions are not followed.

**Precaution:** It means that if the precautions are not observed, the mini-excavator will be damaged or cause failure.

**Supplemen:** It means other supplementary instructions that are helpful for use.

Before using the mini-excavator, please read and understand the operation manual carefully to ensure safe operation. For safe operation, please observe the above precautions and attach the supplement sign here to ensure safety first.

1. Battery maintenance sign:



**Note:** when the machine is not in use, please turn off the power switch in time to prevent the loss of battery power to bring you unnecessary trouble.

2. Daily inspection:

▲ please confirm whether there are abnormal faults (such as oil leakage, loose bolts and nuts, loose electrical wiring, end wires, terminals, etc.) during the last use.

If there is a fault, please dispose it accordingly.

▲ Please use the specified brand for fuel



and grease.

3. Operation diagram for working device

▲ Check whether the mini-excavator control mode is consistent with that indicated on the label. If there is a difference, replace the label before operating the mini-excavator to match the mini-excavator control mode.

▲ If the mini-excavator is not operated according to this procedure, it may cause casualties (refer to the operation warning).

Mechanical operating system (forehand)

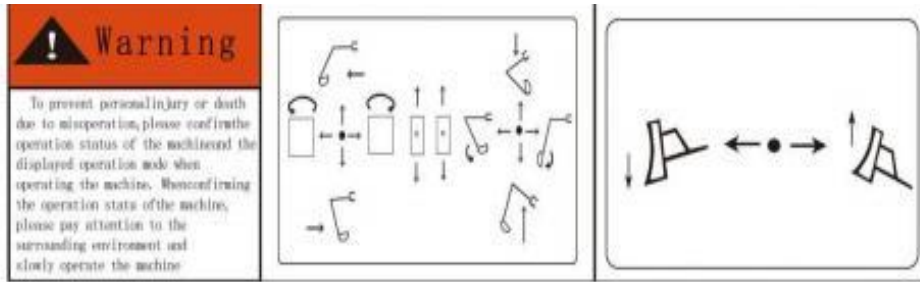

4. When pulling up the bucket, no one is allowed to enter under the bucket.

When pulling up the bucket, please do not touch the overhead wires or obstacles. In particular, death may be caused by electric shock when touching wires, so please pay attention to this matter.



5. Take safety as the guideline, do not drive when you are drinking, taking medicine and in poor health, otherwise it will cause accidents.



6. The exhaust port of the engine is very hot. Do not touch it to avoid scalding.



## Precautions during operation of the mini-excavator:

Ensure good line of sight: when working in a dark place, turn on the work lights and headlights of the mini-excavator, and install additional lighting, if necessary.

When the line of sight is poor due to bad weather (fog, snow, rain or haze), stop operating the mini-excavator until the line of sight improves.

Do not carry people on the mini-excavator: no one is allowed to stand on any part of the mini-excavator at any time when the mini-excavator is walking or operating.

Confirm the performance limits of the mini-excavator. It is forbidden to engage in work beyond the working range of the mini-excavator, which is easy to cause injury to personnel or objects.

The signalman is responsible for sending safety signals at the shoulder, narrow place or blocked line of sight. Do not allow anyone to enter the turning radius and path of the mini-excavator. you can use the horn to express your intention to move the mini-excavator. Since there is a blind area in the rear of the mini-excavator, please check the safety of the rear and make sure that there is no one behind it.

Before operating the propel lever / pedal, make sure that the bulldozer is located in front of the driver's seat. Remember that when the bulldozer is located behind the driver's seat, the operation direction of the propel lever / pedal must be opposite to that of the bulldozer in front of the driver's cab.

### **Safe walking**

The bulldozer blade should be raised when walking

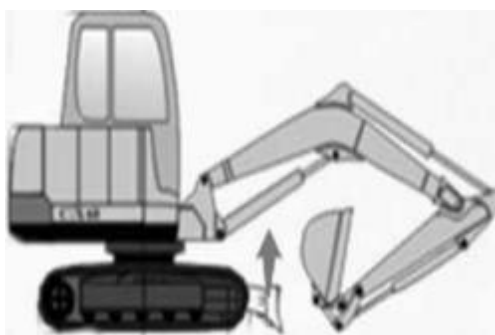

Avoid crossing obstacles as much as possible. If this is necessary, keep the bucket unit close to the ground, and walk it slowly. Do not cross obstacles that will tilt the mini-excavator by 10 ° or more.



On uneven roads, you should keep the mini-excavator walking at a low speed to avoid sudden starting, stopping or changing direction. Otherwise, the working device may come into contact with the ground and cause the mini-excavator to lose balance and damage or damage the building structure in the surrounding area.

Precautions for walking on slopes

Please be careful not to overturn or slide the mini-excavator when walking on a slope or ramp.

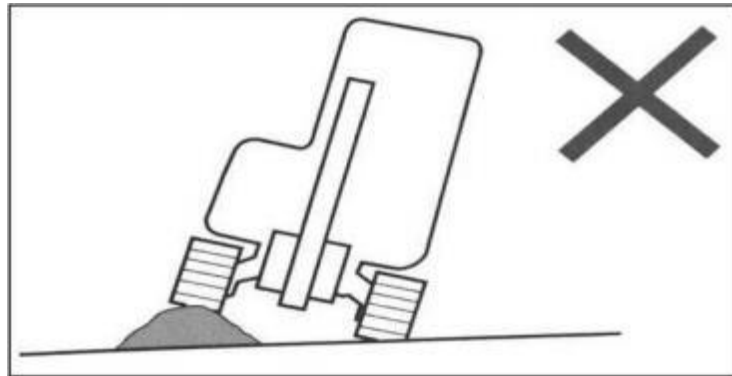

Do not operate the mini-excavator on an excessively steep slope where the

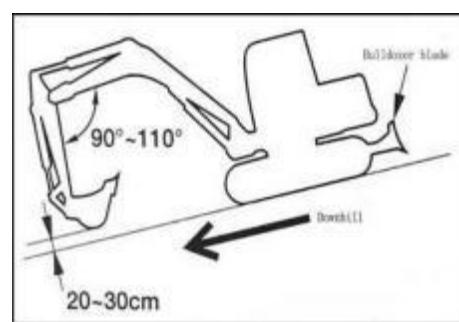
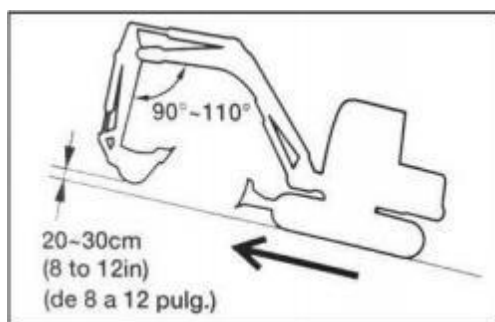

mini-excavator cannot keep its stability (Maximum slope: 30°, lateral inclination: 10°); Please note that in fact, depending on the working conditions, the stability of the mini-excavator will be lower than the above value.

When climbing, keep the driver's seat facing the hillside. When going downhill, keep the driver's seat facing downhill. In both cases, pay attention to the ground state in front of the mini-excavator at the time of walking.

When the mini-excavator is moving on a slope, lower the bucket 20 cm to 30 cm above the ground. When climbing a steep slope, extend the bucket unit to the front of the mini-excavator. In an emergency, lower the bucket to the ground and stop the engine.

When the mini-excavator is moving on a slope or ramp, drive it slowly at low speed.

When the mini-excavator is on a downward slope, the engine speed shall be reduced.

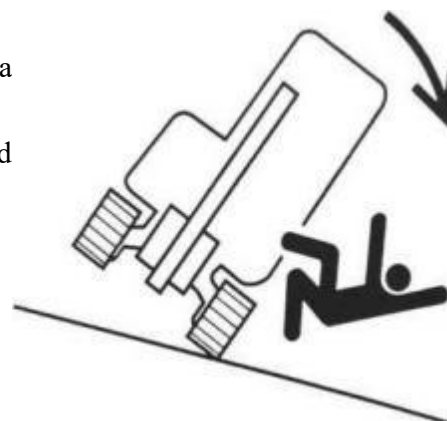

Do not reverse down the slope.

Do not change the direction of movement of the mini-excavator on a slope or cross slope. First return to the flat ground, and then choose another path.

When moving on gentle slopes covered with grass or dead leaves, or on wet metal plates or frozen ground, the mini-excavator may slip sideways. Make sure not to park the mini-excavator laterally on a slope.

If the mini-excavator stalls on a slope, return each control lever to the neutral position and restart the engine. Use extreme caution when operating mini-excavator on snow or ice.

When driving the mini-excavator on snow or icy ground, drive it at low speed to avoid sudden start, stop or change of direction.

The bulldozer blade should be lowered when the mini-excavator is parked on unstable ground.

Do not move the bucket over the worker's head. If the operator moves the bucket over the worker's head, there is a risk that the loaded substances will scatter or the bucket will fall suddenly (as shown in the figure below).

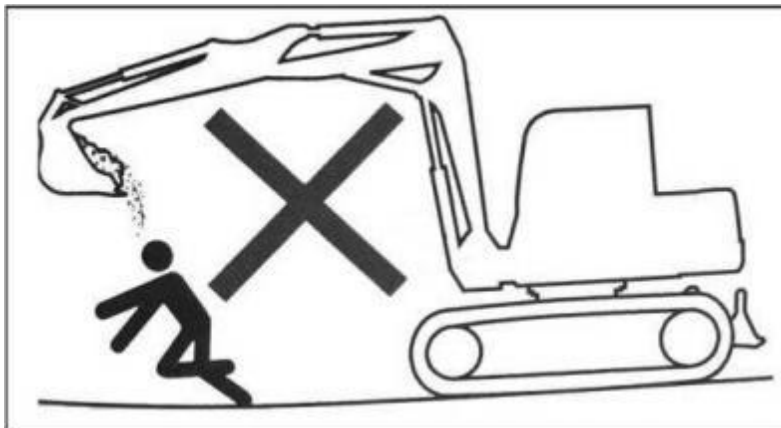

**The driver's safety should be ensured absolutely during loading**

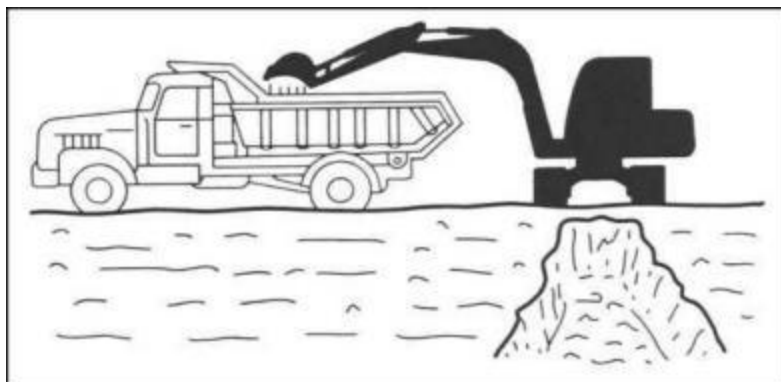

The mini-excavator should keep a safe distance from the high-voltage cable during the driving or working.

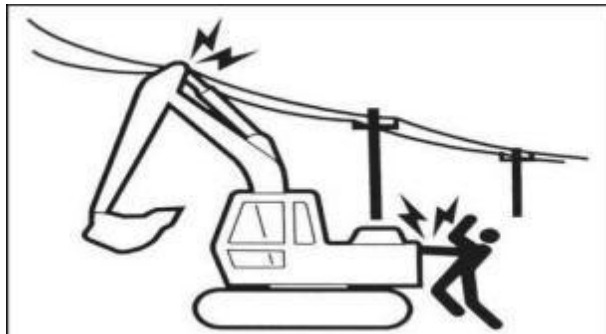

High voltage cables buried underground (as shown in the figure below). Before construction, confirm with relevant personnel whether there are underground cables at the construction site.

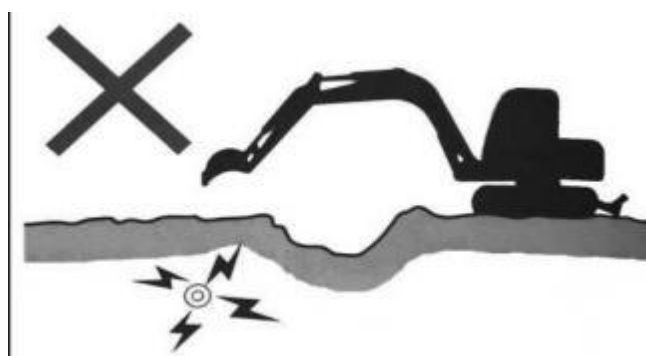

Do not work in the environment with collapse or rockfall hazards, and the corresponding protective measures should be taken.

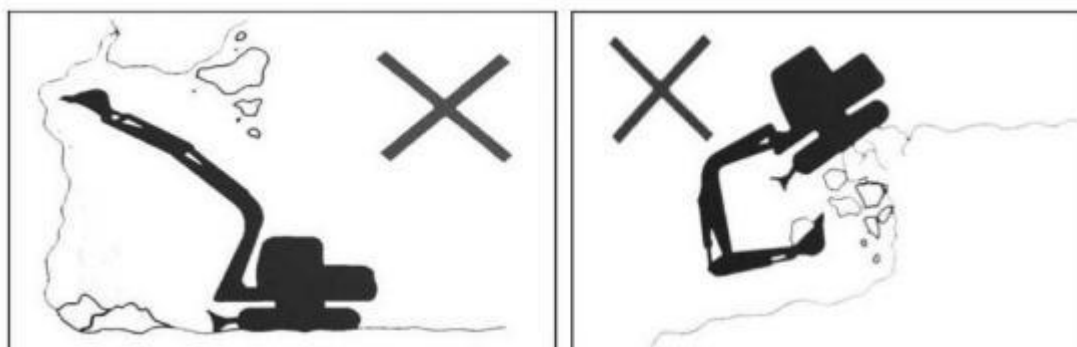

Do not work in the environment with collapse or rockfall hazards, and take corresponding protective measures.

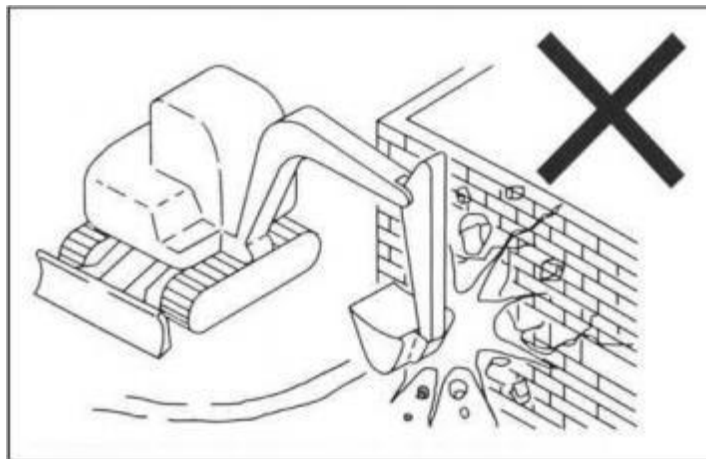

When the mini-excavator is operated on a slope or ramp, the swing or operating device may cause the mini-excavator to lose stability and overturn.

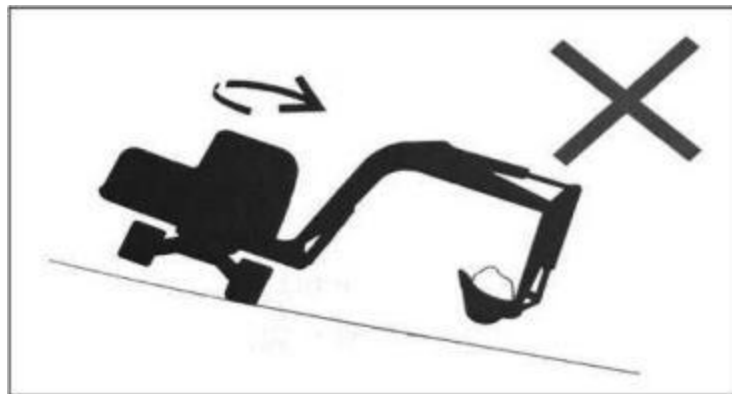

Do not operate the mini-excavator on a slope as far as possible.



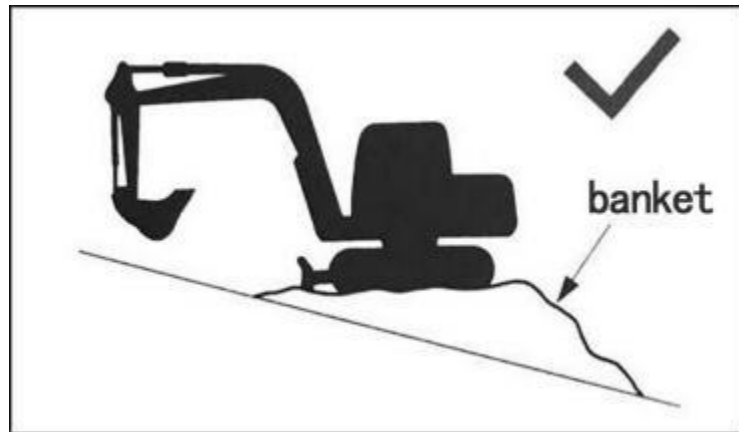

When the mini-excavator is running or working, pay attention to the height between the mini-excavator and the top of the construction environment.

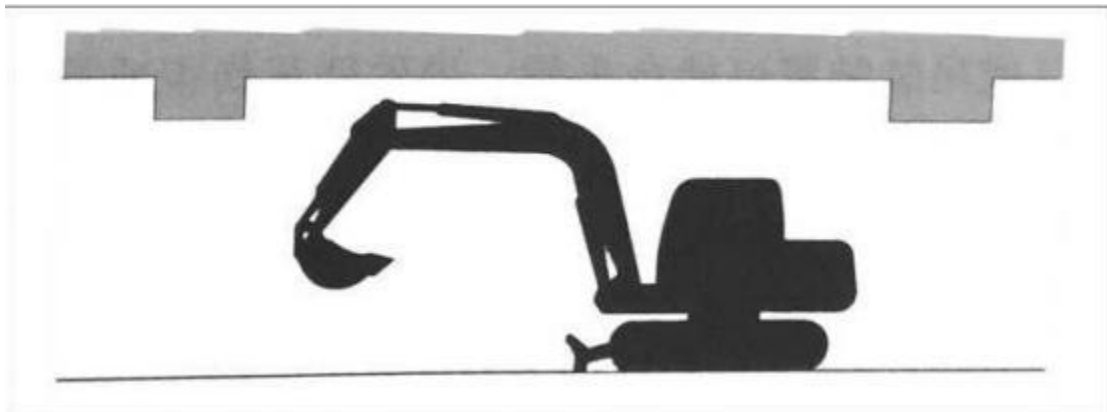

Please do not make the mini-excavator overload or overlength during hoisting. Overload can result in the overturn of the mini-excavator, thus resulting in serious injury to personnel or death.

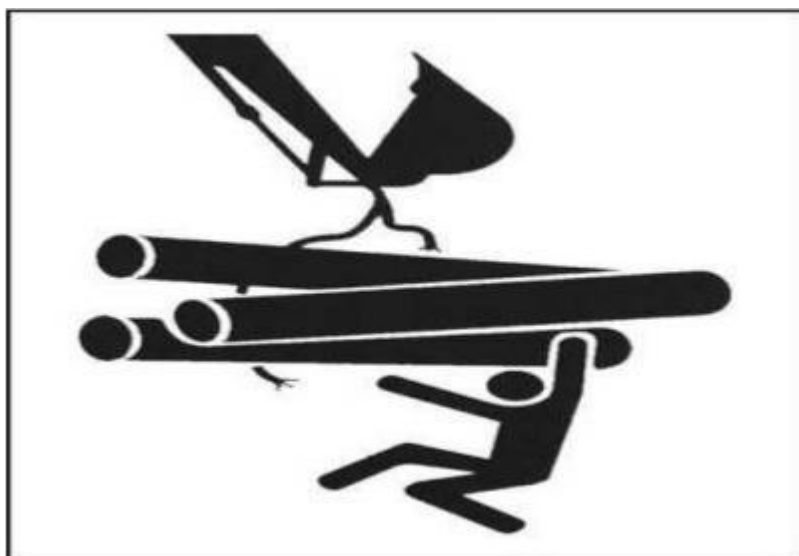

## Traction precautions:

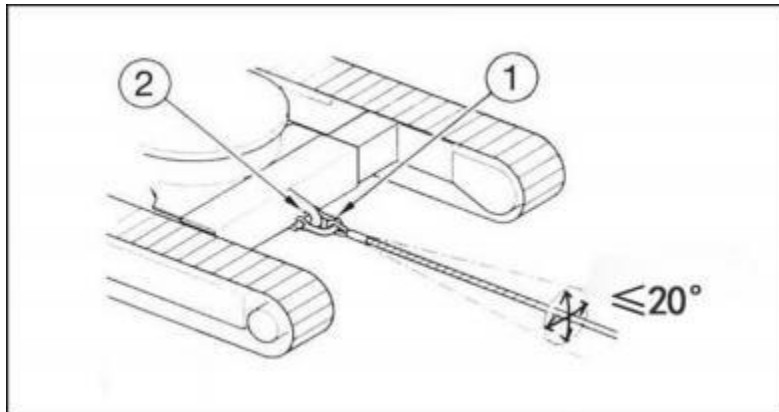

Serious injury or death may result from improper operation, use of wrong cables or improper inspection when towing the mini-excavator.

This can be dangerous if the cable is broken or disengaged. Please use the steel wire rope matching the traction force, and do not use the twisted, twisted or even damaged cable; Do not suddenly apply heavy load on the cable; Wear safety gloves when handling cables.

Ensure that there is an operator on each mini-excavator that is towing or being towed. Do not tow the mini-excavator on a slope.

When towing the mini-excavator, no one should approach the cable.

## Excavation

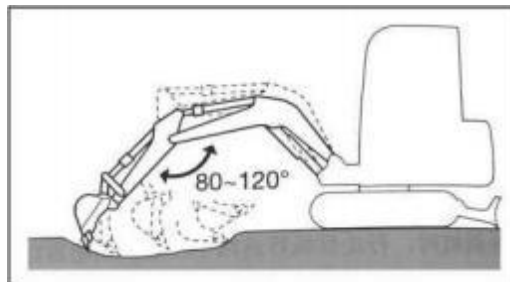

When excavating with stick and bucket, the excavation depth should be shallow and the excavation stroke should be long. The digging force is maximum when the angle between the swing arm and the bucket rod is 80 ° to 120 ° . This angle should be used for effective excavation.

## Digging ditches

In order to improve effectiveness, install a bucket suitable for digging ditches and adjust the caterpillar band to a position parallel to the ditch to be dug.

When digging a wide ditch, the side part shall be excavated first, and then the middle part.

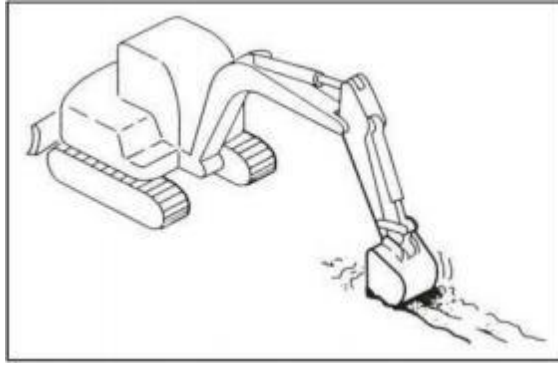

### **Leveling**

- 1 Put the bucket working device close to the mini-excavator body.
  - 2 Slowly push the soil away from the side of the mound.
  - 3 When the height of the soil mound is low, push the soil from its top.
- If the load is too heavy, raise or lower the bulldozer blade for the mini-excavator.

### **Handling rubber caterpillar band:**

Due to the use of rubber, the rubber caterpillar band has an inherent weakness, that is, lack of strength. Please observe the following prohibitions and precautions to prevent the caterpillar band from being damaged or falling off.

### **Prohibitions**

Do not run or operate the mini-excavator in the following places: gravel, extremely rough and hard rock, steel beam, scrap iron, or moving and rotating near the edge of steel plate, which will damage the rubber caterpillar band.



When the mini-excavator walks on the riverbed or where there are a lot of pebbles, it may cause the stones to get stuck in the caterpillar band and damage the caterpillar band, or make the caterpillar band fall off.

Do not operate this mini-excavator at the seaside. Salt may corrode the mini-excavator.

Please observe the following precautions when operating this mini-excavator:



Do not use the bucket operation device to rotate the frame when raising it in front of the mini-excavator (there is no rotation on the mini-excavator).

Otherwise, the load will be concentrated on the caterpillar band, and the single point is to twist the track, resulting in rapid damage and falling off of the caterpillar band.

Prevent the track from falling, so that the rubber caterpillar band will be strongly impacted.

When the rubber track is stored for a long time (three months or more),

Please store it indoors where it is not exposed to direct sunlight or rain.

### Hydraulic breaking hammer

For the operation of the hydraulic breaking hammer, refer to the manual of the hydraulic breaking hammer provided separately by us.

When installing components such as hydraulic breaking hammer, tilt bucket or grab bucket, it is ensured that they are suitable for the mini-excavator model being used. When selecting components, please contact your sales or after-sales service personnel.



The hammer head shall be perpendicular to the working surface for breaking operation.

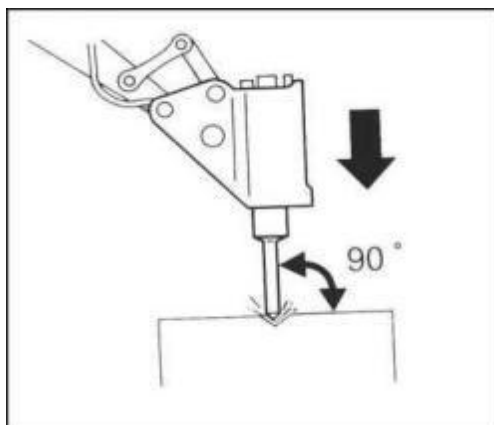

In order to avoid hitting the air, during crushing, the hammer head shall be properly aligned with the object to be crushed.

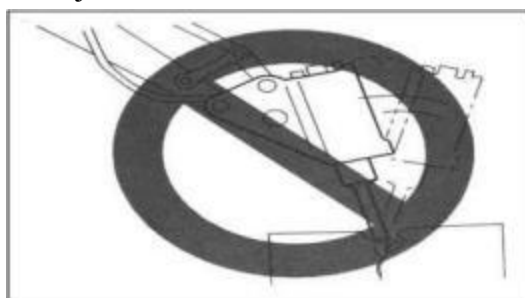

Do not pry the working surface with a hammer, and do not pry the working surface when it is broken; Do not move the hammer head when breaking.

On the same surface, do not impact continuously working surface for more than 30 seconds.

Do not carry out breaking operation when the oil cylinder is fully extended or fully retracted (end of stroke). Leave a gap of at least 50mm.

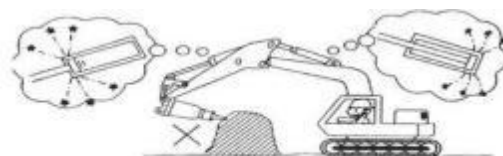

The bucket rod shall not be damaged when placed perpendicular to the ground



Do not hit the object to be broken by the fallen breaking hammer;

Do not use the breaking hammer to move the object or rock block to be broken. If the hydraulic pipe vibrates abnormally, nitrogen may leak from the pressure reservoir. Please check it as soon as possible.

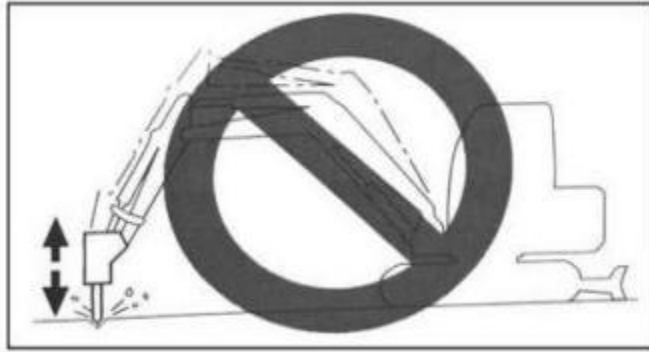

Precautions when stopping:

Safe parking



Park the mini-excavator on flat, firm and safe ground.

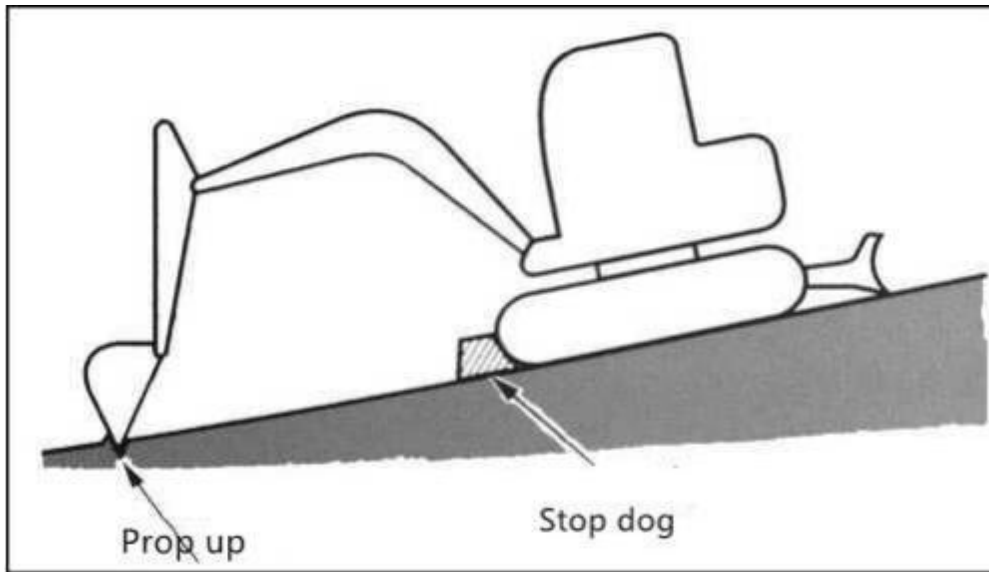

If it is necessary to park or tilt the mini-excavator on a slope, park the mini-excavator firmly and prevent the mini-excavator from moving.

When parking on the street, grids, warning signs, lights, etc. shall be used to make the mini-excavator easy to see even at night to avoid collision with other vehicles.

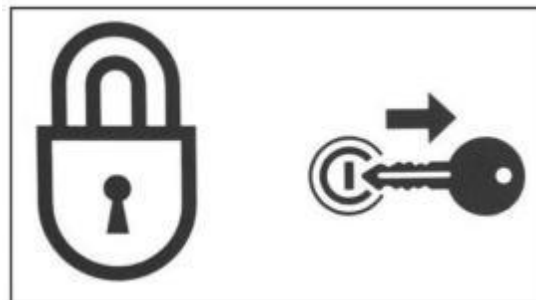

When the excavation work is completed by the mini-excavator or the mini-excavator has stopped operation, the bucket shall be lowered to the ground. After completion of work, pull out the engine start key.

### Precautions during transportation:

Safe loading/unloading mini-excavator

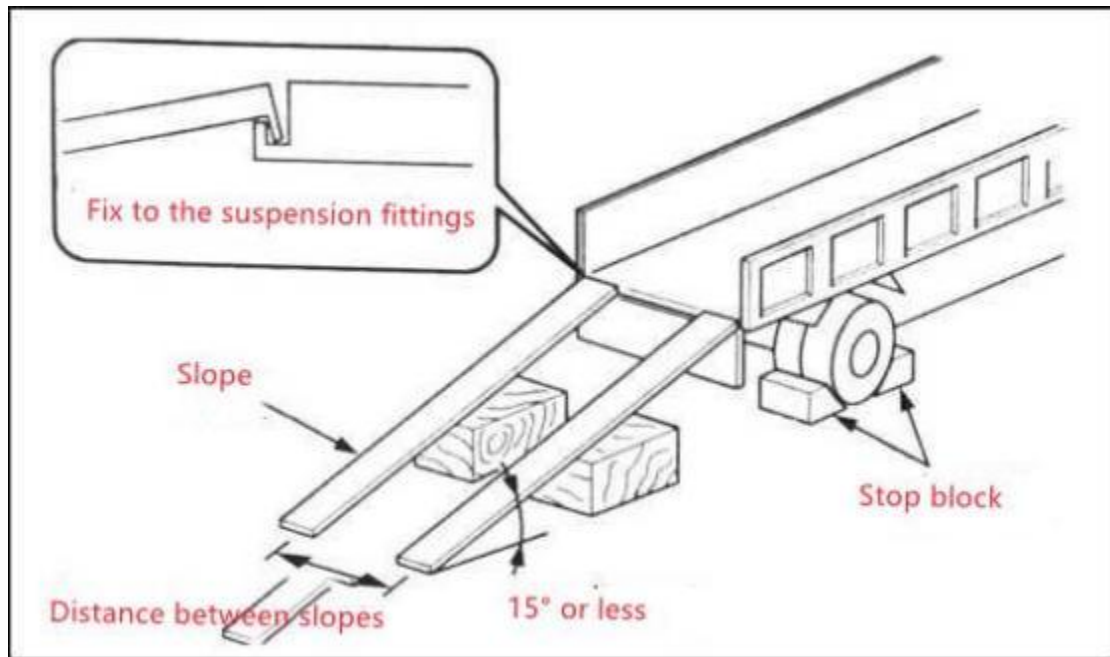

During loading and unloading, the mini-excavator may overturn or fall. Please take the following safety measures:

Select a solid and flat ground and keep a sufficient distance from the shoulder; Fix the ramp of sufficient strength and size to the truck compartment, the slope of the ramp shall not exceed 15 degrees. If the downward curvature of the ramp is too large, support it with struts or cushion blocks.

Keep the truck compartment and loading surface clean and free of oil, sand, ice, snow and other foreign matters to prevent the mini-excavator from sideslip. Clean the caterpillar band.

Wedge the wheels of the transporter to prevent movement.

When loading and unloading the mini-excavator, please follow the signal of the signalman and walk slowly in low gear.

The route shall not be changed on the slope. Do not turn/swing the mini-excavator on an inclined plane. It is likely to turn over.

When turning/swinging on the truck compartment, the footing may not be stable enough, so it should be carried out slowly; If possible, lock the doors and covers after loading. Otherwise, doors and covers may be opened during transportation. Check the caterpillar band firmly with a wedge, and then fasten the mini-excavator to the truck compartment with a cable or chain.

Lift the mini-excavator safely and use correct lifting gestures.

Check the lifting equipment every day to see if any parts are damaged or missing, and replace them if necessary. When hoisting, please use a cable that can lift the weight of the mini-excavator. Lift the mini-excavator according to the procedure



described below. Do not operate the mini-excavator in any other way, otherwise the mini-excavator may be out of balance.

Do not carry out hoisting operation when there are operators on the mini-excavator.

Please lift the mini-excavator slowly to avoid overturning. Keep all personnel away from the operation area during hoisting. Do not move the mini-excavator above the head.

### Safely transport mini-excavator

When transporting the mini-excavator, understand and observe the applicable safety regulations, vehicle codes and traffic rules. The length, width, height and weight of the transport truck after loading the mini-excavator shall be considered to select the best transport route. Do not start or stop suddenly or drive at high speed during transportation. Otherwise, the loaded mini-excavator will move or lose balance.

### Maintenance precautions

Marking with "do not operate" warning message: during checking or maintaining the mini-excavator, if unauthorized personnel start the engine or touch the control device, serious injury may be caused. Before maintenance, please turn off the engine, remove the key and take it with you. The warning message "do not operate the mini-excavator" shall be marked in a conspicuous place, for example, the start switch or control lever.



**Schematic Diagram for Lubrication of Key Structures**

**Hose handling:**

Leakage of lubricating oil or fuel oil can cause fire disaster.

Do not twist, bend or strike the hose.

Twisted, bent or cracked pipes, metal pipes or hoses shall not be used, otherwise explosion may occur.

Retighten the loose joint.

### **Precautions for operating high temperature and high pressure parts:**

1. Please shut down the engine and wait for the mini-excavator to cool down before maintenance.

2. The engine, exhaust pipe, hydraulic pipe, sliding parts and many other parts of the mini-excavator are very hot when the engine cylinder just stops. If you touch these parts, you will be in danger of scalding.

3. Engine coolant, hydraulic fluid and other oils are also subjected to high temperatures and pressures.

4. Do not touch the hydraulic oil when loosening the cover or plug. If you operate the mini-excavator under this condition, scald or injury may be caused by hot oil spray.

### **Be careful of the internal pressure of the hydraulic oil:**

1. After the engine is shut down, the pressure in the hydraulic oil pipe will be maintained for a long time. The internal pressure should be completely relieved before operator carries out maintenance work.

2. Because the hydraulic oil pressure in the oil pipe is relatively high, it can pierce the skin or eyes, thus causing serious injury, blindness and even death. Remember that the hydraulic oil seeping from the small hole is almost invisible. When checking for leaks, operators should wear goggles and thick gloves and protect their skin with cardboard or plywood, to prevent the hydraulic oil from spraying and being injured.

### **Beware of high pressure grease:**

In the caterpillar band tensioning device, grease will splash under high pressure.

The tension shall be adjusted according to the following specified procedure, The grease relief valve may fall off, thus resulting in personal injury.

Do not loosen the grease fittings.

Slowly loosen the grease relief valve without turning it more than one turn.

Do not place face, arms, legs or body in front of the grease relief valve.

When loosening the grease relief valve, if no grease flows out, the valve fails. In this case, do not disassemble the tensioning device, because the spring in the tensioning device will pop out, which will cause serious injury. Do not remove the caterpillar band tensioning device.

### **Precautions for battery:**

1. Disconnect the battery line before electronic system operation or welding. First disconnect the negative battery cable, and finally connect the negative battery cable when reconnecting.

2. When starting the engine with the battery charging line, do not touch the

positive (+) and negative (-) clamps of the battery charging line or contact the mini-excavator. Wear goggles and gloves when maintaining the battery.

3. If having any questions to consult during use and maintenance, you can contact the company's sales or after-sales personnel at any time to learn more about the use and maintenance of the equipment.

### **Vibration undertaken by operators:**

The test results on the vibration transmitted by the mini-excavator to the operator indicate that the vibration on the upper limb of the operator is less than  $2.5\text{m/s}^2$  , In the seat, the vibration borne by the body is less than  $0.5\text{m/s}^2$  .

### **Regular inspection and maintenance:**

In order to ensure good performance of the mini-excavator, the mini-excavator shall be maintained on time according to the nature of work during use.

The following figure shows simple routine maintenance procedures:

Periodic Inspection List for Mini- excavator																	
No	Items	Time	Tuner display time										After this				
			50	100	150	200	250	300	350	400	450	500		550			
1	Working device	Grease														Every day	
2	Fuel oil	Drainage	○	○	○	○	○	○	○	○	○	○	○	○	○	○	Every 50 hours
3	Engine oil	Replacement	○			○											Every 250 hours
4	Oil filter	Replacement	○			○											Every 250 hours
5	Diesel filter	Replacement	○			○											Every 300 hours
6	Air filter element	Replacement	○					○							○		Every 300 hours
7	Hydraulic oil	Replacement													○		Every 800 hours
8	Hydraulic oil filter	Replacement													○		Every 500 hours
9	Line	Inspection															Every 1,000 hours
10	Anti-freezing liquid	Inspection															Every year
			1: Clean or replace the air filter element in time according to the working environment (at least every 50 hours).														
			2: Add anti-freezing liquid in time when it is reduced.														
Note			3: When not working for a long time, the negative pole of the battery needs to be removed, and the negative pole connector can be wrapped with insulating tape to prevent oxidation and corrosion of the connector.														
			4: When working with a crushing hammer, the maintenance cycle is halved.														
			5: Genuine original maintenance filter element shall be used for machine maintenance accessories.														

See the next page for more details of precautions.

## Regular inspection and maintenance

### Remarks:

1. When using hydraulic front-end working devices such as breaking hammer, please replace the hydraulic front-end working device in the following way according to the service times of the hydraulic front-end working device:

Use time ratio of hydraulic auxiliary device	Replacement time of hydraulic oil	Replacement time of return oil filter
Standard operation (backhoe operation)	Every 1,000 hours	Every 500 hours (initial 4,250 hours)
Use ratio of breaking hammer is 20%	Every 800 hours	Every 200 hours
40%	Every 400 hours	
60%	Every 300 hours	Every 200 hours
More than 80%	Every 200 hours	

Note: after changing the filter, the operator must check the oil level.

2. According to the different working environment, the engine air filter element shall be cleaned and replaced in time. When working in a dusty environment, in order to ensure the normal operation of the engine, the engine air filter element must be cleaned for 10 to 20 hours.

When changing the hydraulic oil, the normal barrel hydraulic oil (46#) must be used. Because there are impurities in the bulk hydraulic oil, the high-speed operation of the hydraulic system will damage the hydraulic components.

**Recommended lubricants:**

<b>Manufacturer</b>	<b>Engine oil</b>	<b>Hydraulic oil</b>	<b>Gear oil</b>
Mobil	DelvacMX( 15W-40) Delvac Surper Multigrades (10W-30/ 15W-40)	DTE 25(VG46)	Automotive gear oil Mobilube HD 80W-90
ESSO	Superfl (10W-40)	NUTO H46	Gear oil GX80W-90
SHELL	RIMULA(SAE10W-30)	Tellus ST46	SPIRAX EP90
Castrol CALTEX	(RX Super) SAE 15W-40; (RX Super) SAE 10W-30	HYDRAULIC series hydraulic fluid (VG46)	
TEXACO	Havoline® Motor Oil 10W-30		Havoline® Gear Oil 80W-90
JOMO	High grade diesel engine oil JOMO DIESEEL CF(SAE15W-40)/ High grade diesel engine oil JOMO DIESEEL CD(SAE10W-30)	JOMOHylux (VG46)	Premium automotive gear oil JOMO GEAR 5

- ▪ ▪ When changing the oil, please drain all the oil and inject new oil

**Waste disposal:**

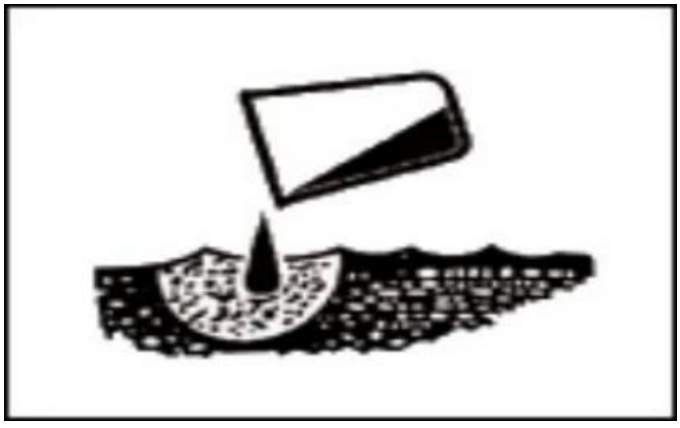

1. Ensure that the waste oil discharged from the mini-excavator is collected in a container. Improper treatment of waste oil will cause harm to the environment.
2. Please follow applicable laws and regulations when handling harmful substances such as lubricating oil, fuel, coolant, solvent, filter and battery.
3. Handling of hazardous chemicals - direct contact with hazardous chemicals can cause serious injury ( The chemicals used in this mini- excavator include grease, battery electrolyte, coolant, coating and adhesive). Please handle hazardous chemicals carefully.