

MAGNUSON

SUPERCHARGERS

Installation Instructions for:
2018-2021* Jeep JL and JT (Not For eTorque)



***This Supercharger System is NOT presently compatible with the GPEC5 PCM.**

PREMIUM 91 OCTANE GASOLINE FUEL REQUIRED



ATTENTION!
Your MAGNUSON SUPERCHARGER kit is sensitive to corrosion!
Use only the vehicle manufacturer recommended coolant for your engine in the intercooler system as well.

Magnuson Superchargers
1990 Knoll Drive, Bldg A, Ventura, CA 93003
(805) 642-8833 phone
magnusonsuperchargers.com

INSTALLATION MANUAL

Magnuson Supercharger Kit: 2018+ Jeep JL and JT (Not For eTorque)

Please take a few moments to review this manual thoroughly before you begin work: Make a quick parts check to be certain your kit is complete (see Bill of Material (BOM) parts list inside the accessory box). If you discover shipping damage or shortage, please call our office immediately. Take a look at exactly what you are going to need in terms of tools, time, and experience. Review our limited warranty with care.

Use only premium gasoline fuel, 91 octane or better. The use of non-premium fuel can cause engine failure and will void your warranty.

Magnuson Products recommend that you run a minimum of one tank of premium 91 octane or better fuel through your vehicle prior to installation of the system to prevent any possible damage that may occur due to running the supercharged engine on lower octane fuel.

DO NOT RUN E85 FUEL WITH THE SUPERCHARGER.

DO NOT USE OCTANE BOOSTERS. If you have used octane boosters in the past you will have to replace your spark plugs and the O2 sensors.

Magnuson Superchargers systems are designed for engines and vehicles in “GOOD” mechanical condition. Magnuson Superchargers recommend that a basic engine system “Health Check” be performed prior to the installation of this supercharger system. Be sure to check for any pending or actual OBDII codes and fix/repair any of the stock systems/components causing these codes. If there are codes prior to the installation they will be there after the installation.

Magnuson Superchargers also recommend the following services to be performed on your vehicle while installing the supercharger system:

- Fuel Filter change
- Engine oil and filter change using brand name oil (organic or synthetic) and filter
Note: It is VERY IMPORTANT to use the factory specified oil viscosity. The original equipment manufacturer has selected this grade of oil to work with your other engine systems such as hydraulic chain tensioner and variable cam controls. Deviation from this specification may cause these systems to fail or not function properly. Please refer to your owner’s manual for the recommended oil viscosity or your engine and application.
- **Unless an engine has less than 5000 miles, it is HIGHLY recommended that new spark plugs are used for this installation. Replace with: NGK #6706. It is also important that the new spark plugs be gapped to 0.032” prior to installation. If re-using stock spark plugs, they must be removed and re-gapped to 0.032” prior to re-installation.**

On older vehicles Magnuson Superchargers recommend these additional services to be performed:

- **New spark plugs with the air gap set at 0.032”.**
- Coolant system pressure test and flush.
NOTE: YOU MUST USE JEEP SPECIFIED COOLANT MIXTURE!

Non “Magnuson Superchargers Approved” calibrations or “tuning” will Void ALL warranties and CARB certification.

Our supplied calibration is designed for use with the components provided in this kit. Any adjustment to the intake, or exhaust systems or other engine components may adversely affect engine performance and may trigger your check engine light.

Tools Required

- Metric wrench set**
- Metric 3/8" and 1/2" drive metric socket set (standard & deep)**
- 3/8" and 1/2" drive ft-lbs and in-lbs torque wrenches**
- Metric Allen socket set 3/8 drive**
- Metric Allen wrenches**
- Phillips and flat head screwdrivers**
- Serpentine belt tool**
- Funnel**
- Drain pan**
- Hose cutters**
- Hose clamp pliers**
- Safety glasses**
- Nut driver**
- Compressed air**
- Air gun**
- Heat gun**
- Torx socket set 3/8 drive**

Contact Information:

Magnuson Superchargers
1990 Knoll Drive, Bldg A
Ventura, CA 93003

Sales/Technical Support Line: (805) 642-8833
Websites: www.magnusonsuperchargers.com
Email: sales@magnusonsuperchargers.com

Table of Contents

Section 1: Initial Preparation	5
Section 2: Front Grill, and Engine Cover Removal	7
Section 3: Air Inlet, Vacuum Pump and Alternator Removal	10
Section 4: Intake Manifold Removal	14
Section 5: Heater Line and Fuel Line Removal	22
Section 6: Pump Install	33
Section 7: Wiring	34
Section 8: Horn And Ambient Air Temp Relocation	38
Section 9: I/C Hose Installation	42
Section 10: Install Low Temperature Radiator (LTR)	46
Section 11: Lower and Upper Intake Preparation	48
Section 12: Main Installation	54
Section 13: Intercooler System Filling and Air Removal	70
Section 14: Oil Filter and Fill Cap Removal Information	73

Any reference to the left or right side of the vehicle is given from the driver's seat perspective.

Section 1: Initial Preparation

1. Before beginning the installation run a full tank of premium 91 octane or higher fuel through your engine. **DO NOT USE E85 FUEL OR OCTANE BOOSTER!** The vehicle must have premium fuel prior to starting the install.
2. If you purchased the kit without calibration you can disregard this step. If your kit has an PCM shipper box and HP Tuners RTD device you will mail in your PCM for unlock to the address shown in the RTD Flash Tool Instructions. Detailed instructions will be provided in a later step for removing the PCM from your vehicle.

This Supercharger System is **NOT** presently compatible with the GPEC5 PCM.

3. If your kit has a provided handheld tuner follow the instructions in the provided pamphlet to install your tune. **WARNING: DO NOT BEGIN THE INSTALLATION BEFORE OBTAINING YOUR NEW CALIBRATION FILE. IN SOME CASES, ESPECIALLY WITH NEWER VEHICLES, THIS STEP CAN TAKE SEVERAL DAYS AND YOUR VEHICLE WILL BE IMMOBILIZED WHILE YOU WAIT FOR THE NEW CALIBRATION FILE.** The pictures shown may be slightly different from the items you receive.
4. Remove the fuel pump relay from the under hood fuse panel shown here with the green arrow. Start the vehicle to release pressure from the fuel rail/line prior to disassembly. Once you have purged the fuel pressure you can replace the fuel pump relay.

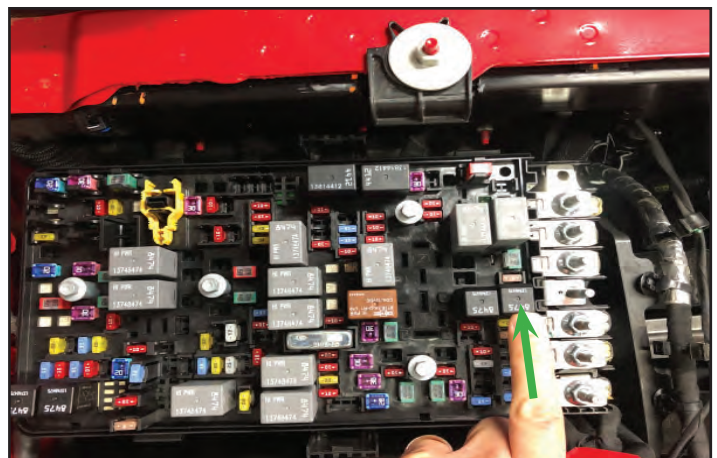

5. Remove the two nuts shown here with arrows on the battery.



6. Insulate the ends of each wire that were disconnected in the last step using thick tape to prevent unintentional grounding.



7. Unplug the wire connection shown from the negative battery terminal.

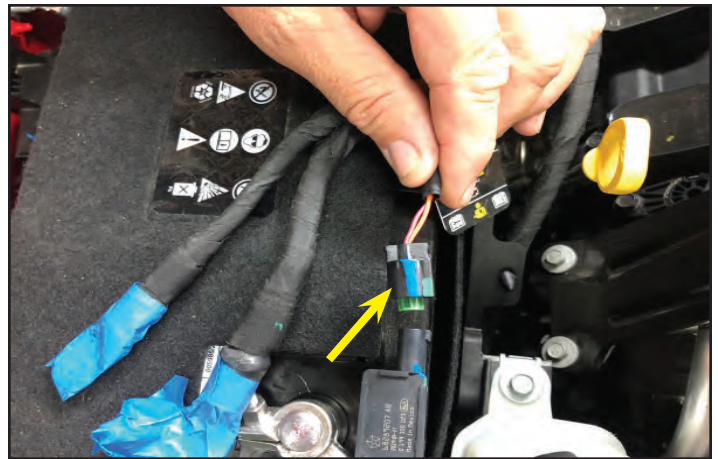

8. **If you are not providing your own calibration you will need to send in your PCM for unlock. There is a box provided for sending in your PCM with instructions included.** Release the two PCM locks at the arrow locations. Then unplug the connections.

This Supercharger System is NOT presently compatible with the GPEC5 PCM.



9. Remove the two bolts holding the PCM in the locations shown with arrows.

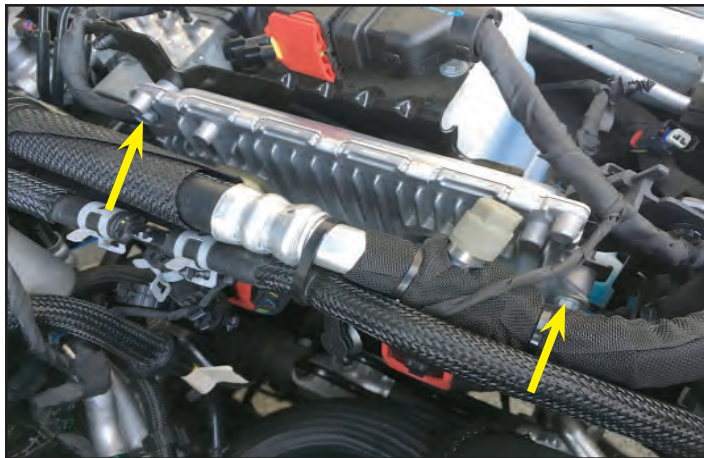

Section 2: Front Grill, and Engine Cover Removal

10. Using proper push pin removal tools, carefully remove 6 push pins along the top core support/horse collar.

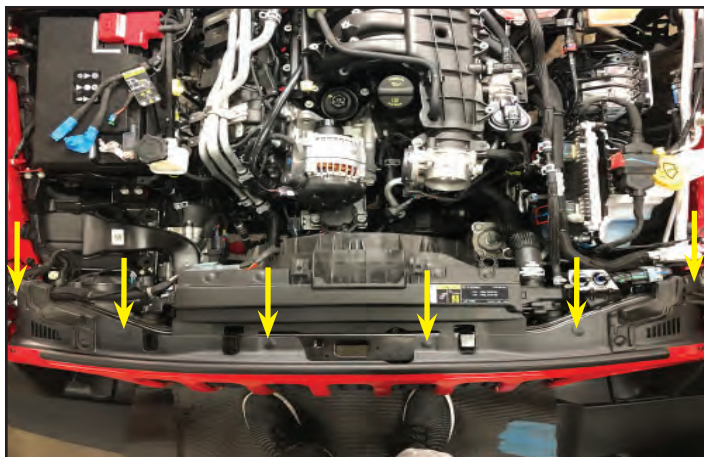

11. Use push pin pliers to remove the 6 push pins.



12. Pry the top core support/horse collars out with a trim removal tool.



13. Pry up on both ends to release the front grille locating pins.



14. Pull the top portion of the grill slightly away as shown here to access the lower retainer clips.



15. Once all push pins have been removed, use an 18" pry bar to carefully release 6 lower retainer clips. This pry bar has been highlighted in green here. The location of one lower clip is shown with an arrow.



16. The arrows show 4 of the lower grill retainer clips, and once again the pry bar is highlighted in green.

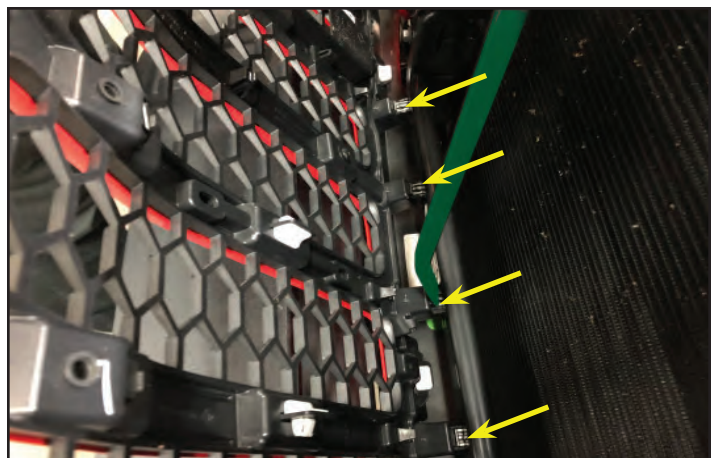

17. Remove front grille from vehicle to prevent damage during install and allow for installation of front radiator in a later step.

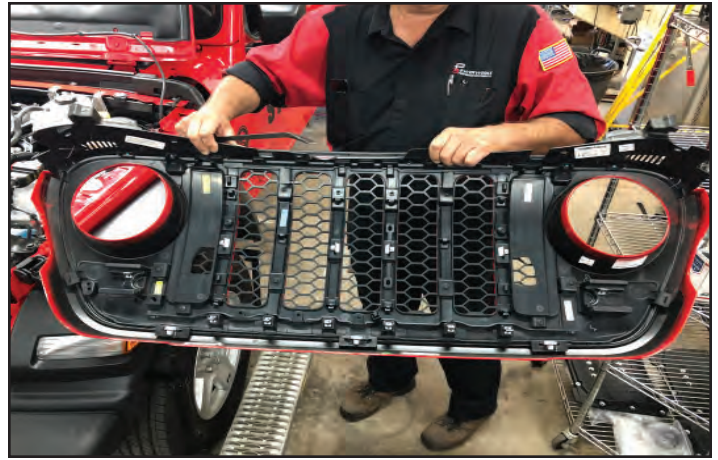

18. Remove 4 push pins shown with arrows which retain the upper closeout panel to the cooling module. Remove the closeout panel from the vehicle.

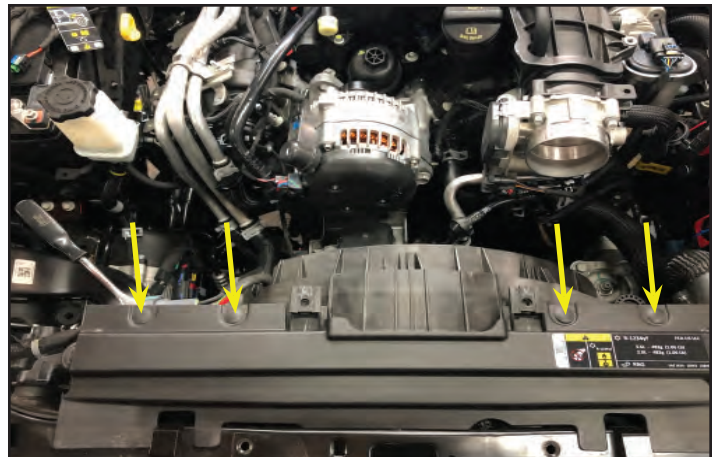
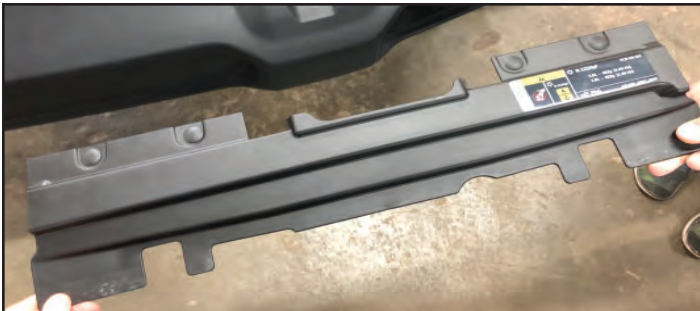

19. Use a T-30 Torx socket to remove the two bolts at the front of the engine cover. Pull back at the cover to release it from the two rubber grommets. The cover will not be reused.



20. Remove the 3 bolts shown with arrows holding the top engine cover bracket using a 10mm socket. Disconnect PCV line from the bracket before removing bracket from vehicle (not shown in picture).



21. Remove three M6 x 15mm bolts shown with arrows using a 10mm socket wrench. Remove the passenger side engine support bracket. This will not be reused. Re-install these bolts in position and **torque to 71 in-lbs.**

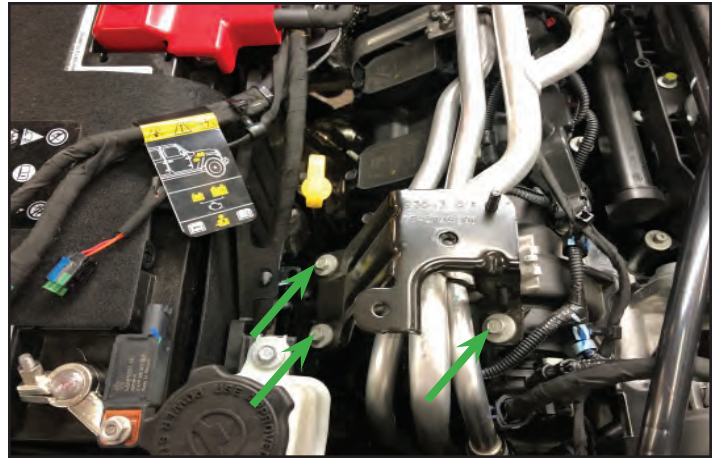

Section 3: Air Inlet, Vacuum Pump and Alternator Removal

22. Remove 3 wiring harness retention push pins from OE air induction tube shown with green arrows and disconnect IAT sensor shown with the red arrow. **Note: You may want to put tape on the IAT connection and set it to the side to prevent damage as it will not be reconnected until later.**



23. Unplug the PCV breather port from the clean air tube shown at the green arrow location by pressing the gray button and pull at the connection.



24. Remove the two bolts at the red arrow locations, and loosen the two hose clamps at the green arrow locations. Disengage the couplers at the airbox and throttle body so the air duct can be completely removed. **Note: The OE air duct will not be reused. The IAT sensor needs to be removed from the duct at this time. (It will be installed into the Magnuson upper intake manifold.)**



25. To remove IAT sensor from the OE air intake duct, gently pry up on the locking tab and rotate counterclockwise. When it is fully disengaged it should pull straight out. **NOTE: You may need to look inside the duct to confirm that the sensor is unlocked.**



26. Remove the bolt shown at the arrow location with a 10mm socket wrench. This bolt secures the airbox. Pull up to remove the airbox assembly.



27. Remove rubber grommets from airbox lower and reinstall into sheet metal shown below.

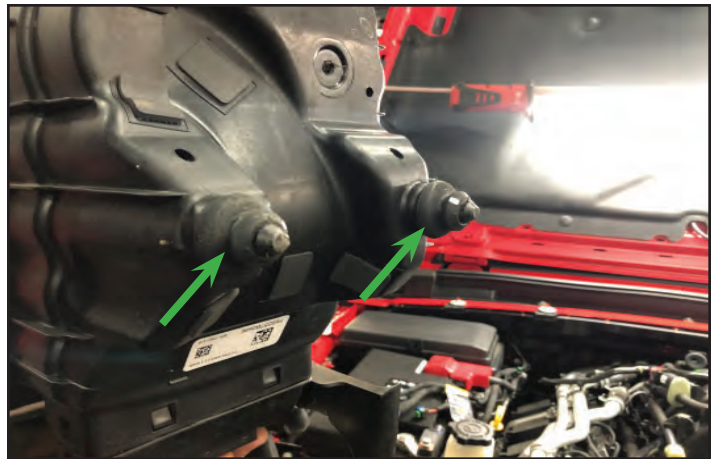
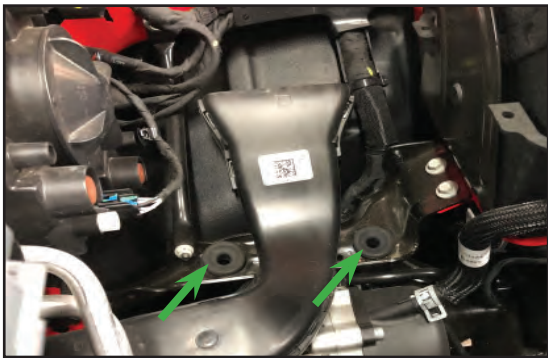

28. Unplug the vacuum fitting to the electric vacuum pump shown here with an arrow.



29. Unplug the wiring harness for the electric vacuum pump shown here with an arrow.

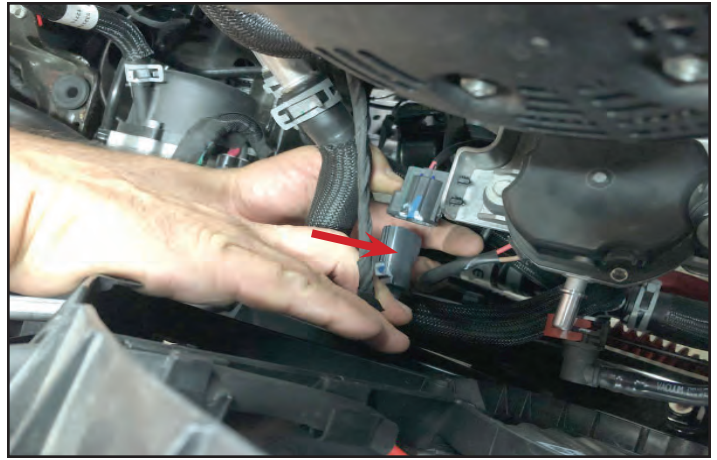

30. Remove the two bolts securing the electric vacuum pump bracket shown here with the two arrows using a 13mm socket wrench.

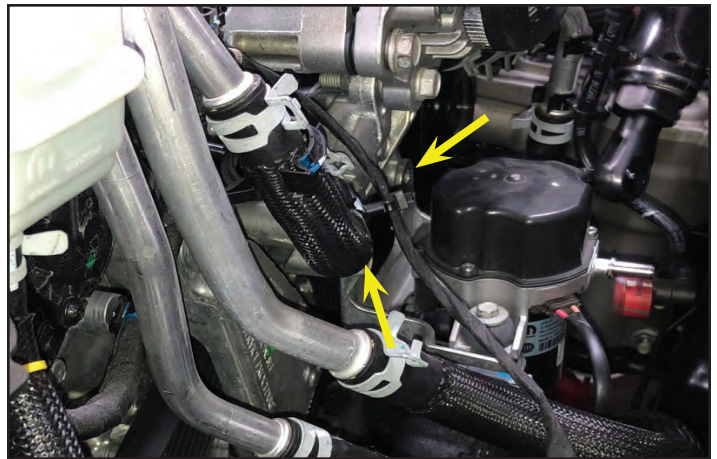

31. Remove the vacuum pump assembly from the vehicle.



32. Locate the 1/2" square location on the belt tensioner shown with a red arrow in the image below. Insert 1/2" x 24" ratchet into the tensioner (yellow arrow) and rotate clockwise.

Note: This vehicle uses a hydraulic tensioner and requires a good deal of force to rotate.



33. With tension removed from belt, slip the belt off the idler located on passenger side as seen here.

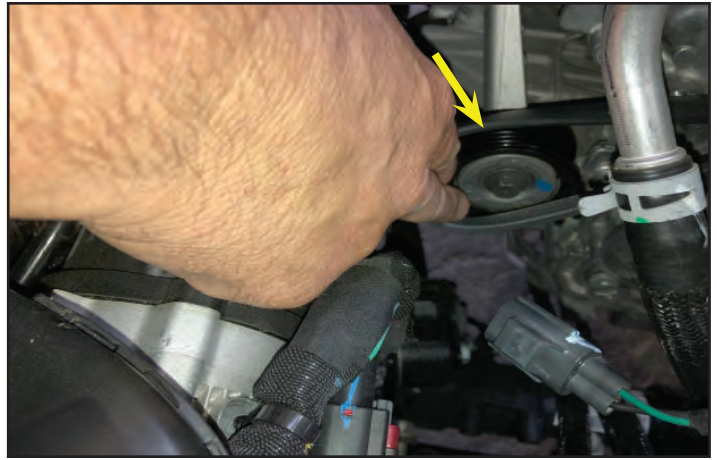

34. Unplug the electrical connector from alternator.



35. Remove power cable from alternator. Wrap cable to insulate end and prevent unintentional circuit grounding.



36. Remove two 13mm inner bolts retaining alternator to engine. Remove two 15mm bolts and slowly remove alternator from vehicle.



37. Remove two bolts retaining the alternator support bracket to engine (One 13mm and one 16mm). Remove alternator support bracket from vehicle and remove factory serpentine belt as well.



Section 4: Intake Manifold Removal

38. Remove 2 push pins from the electrical harness (One to throttle body and one to the throttle body support bracket).



39. To unplug the throttle body electrical connector, first pull out the red locking tab then depress the tab and gently pull to release. **NOTE: Set this part of the harness to the side.**

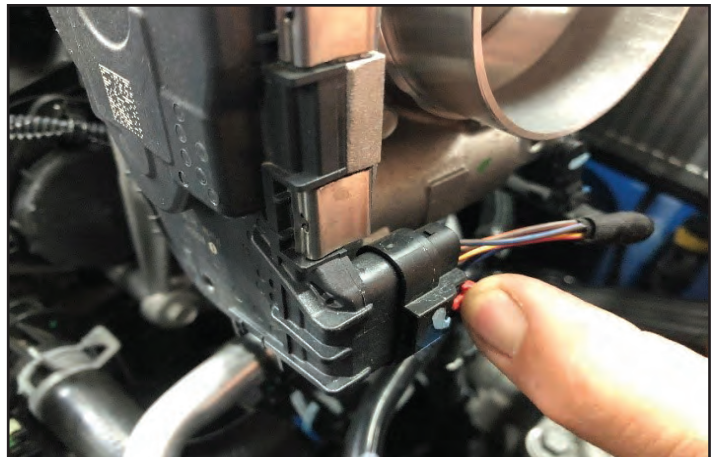

40. To remove the throttle body loosen and remove the 4 bolts with an 8mm socket. **NOTE: Be sure to hold the Throttle Body as this is being performed to prevent damage. The throttle body needs to be reused in a later step.**



41. Remove the 3/8" vacuum hose from intake manifold located between throttle flange and EGR valve shown at the yellow arrow.

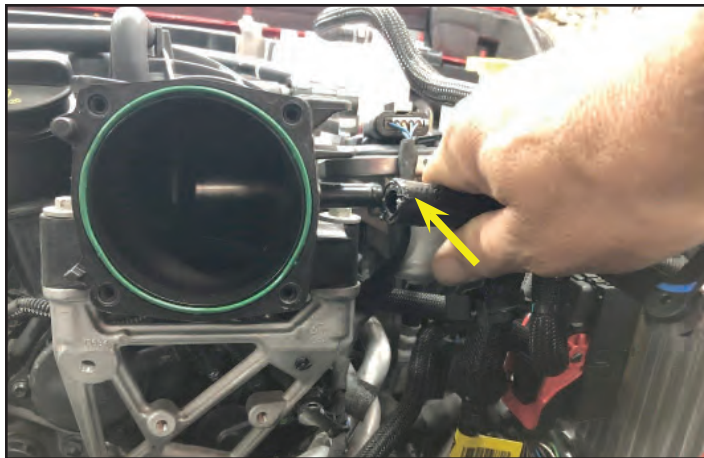

42. Remove the 3/8" VMV (fuel vapor) hose from intake manifold.



43. Disconnect VMV jumper hose from VMV valve (remove red locking clip and depress to release SAE connection).



44. Disconnect VMV jumper hose from the port on the tube bundle located behind the passenger side cylinder head near the dash panel. (remove red locking clip and depress to release SAE connection) Remove the jumper hose from the vehicle. The connectors will be needed in a later step.



45. Unplug the electrical connector from VMV valve.



46. Remove VMV valve and hose assembly from the intake manifold. Note: Keep the hose shown with the arrow to drain coolant.



47. Pull transmission vent line/hose from intake manifold and tuck away near battery to allow for removal of intake.



48. Disconnect PCV (dirty side) from the intake manifold. Disconnect PCV fitting from rear of passenger side cam cover. Remove PCV line from vehicle.



49. Disconnect engine harness from MAP sensor.

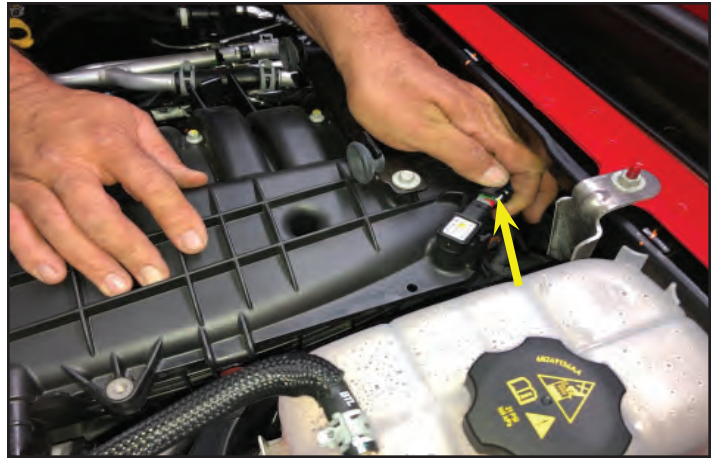

50. Disconnect engine harness from EGR valve. Pull out on the white locking tab then depress and pull to unplug connector.



51. Remove two 10mm nuts at the arrow locations retaining the OE coolant reservoir to the cowl. Pull reservoir up to release lower grommet and to get up over the studs. Temporarily move reservoir forward and toward booster. Use a bungee cord or zip tie to hold it out of the way as shown highlighted in green.



52. Remove the two brown push pins from driver side harness bundle to intake manifold.



53. Remove the 2 bolts with 10mm heads retaining the tube to EGR valve using ratcheting wrench.

Note: Save the bolts for reinstallation.

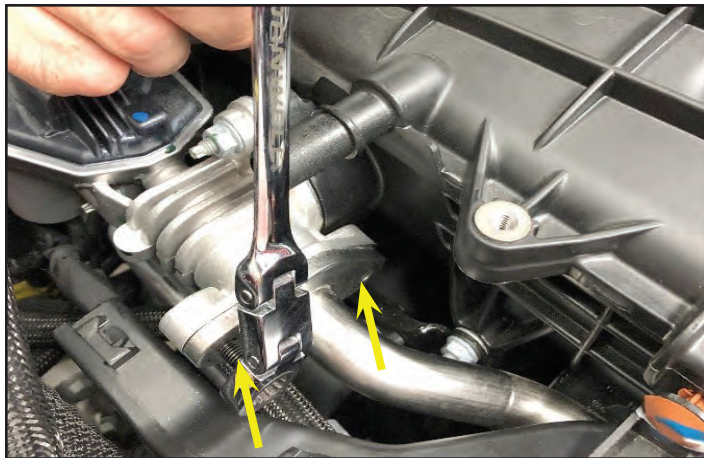

54. Remove EGR rubber coated metal gasket and **save for reinstallation.**



55. Remove 2 nuts retaining EGR tube brackets to intake manifold (only forward location shown in picture) with a 10mm socket wrench.

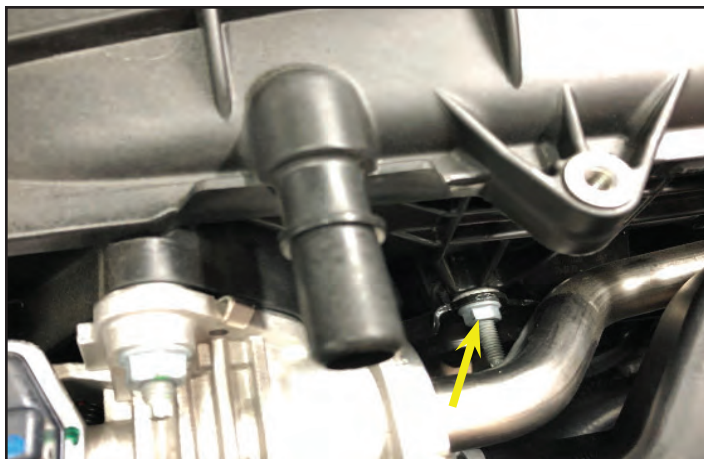

56. Remove the 2 bolts securing the intake to throttle body support bracket with a 10mm socket wrench.

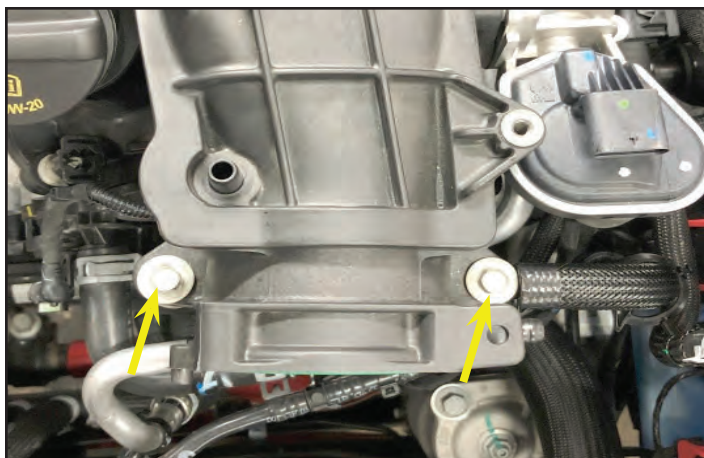

57. Remove eight upper to lower intake manifold mounting bolts with 8mm heads. NOTE: You may want to use a swivel on the rear most bolt for easier tool access during bolt removal.



58. Gently pry up on the locking mechanism at the rear of the oil filter adaptor to the cam cover (at 12 o'clock position when looking down on oil fill) while slowly rotating counterclockwise until it makes contact with the intake manifold. At this point, you will need to "wiggle" the intake manifold to provide some additional clearance to allow for removal of the oil fill cap adaptor.



59. Once removed, install the supplied oil cap on cam cover at arrow location to prevent debris from contaminating the engine.



60. Carefully remove intake manifold. NOTE: The two remaining studs on the intake driver side to intake support brackets will provide some resistance. This is normal. These studs are shown in the next step.



61. Here are the two studs at the yellow arrows that were mentioned in the last step.

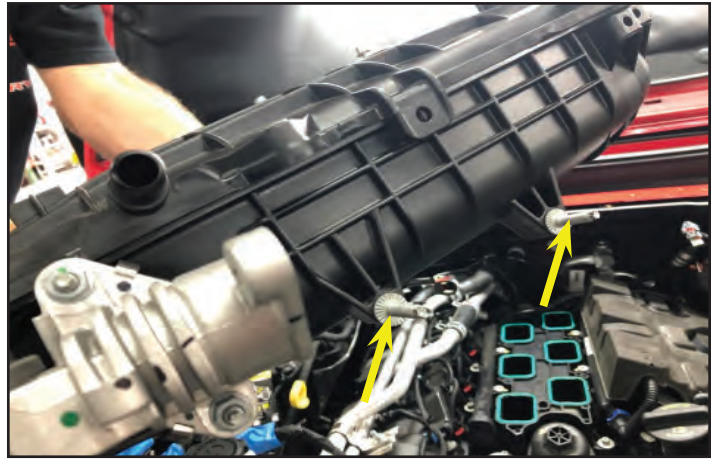

62. Tape off intake manifold ports to prevent contamination into engine.



63. Remove the throttle body gasket from the OE intake manifold and set it aside for a later step.



64. Use a 10mm socket to remove the 3 nuts holding the EGR assembly to the upper intake manifold. Set the EGR valve safely aside to be reused in later steps.

Note: When removing EGR valve you will notice an extension tube attached to the valve. DO NOT REMOVE extension tube.



65. Remove 2 bolts retaining throttle body support bracket to engine front cover with a 10mm socket wrench. Remove throttle body support bracket.



66. Remove foam insulator below intake. This will not be reused.



Wait for the engine to cool before draining the coolant system.

67. Locate radiator petcock and drain cooling system as per Jeep manual. This is located on the driver side inside frame rail behind the bumper. Ideally you would use service coolant system service tools to vacuum, drain and fill.

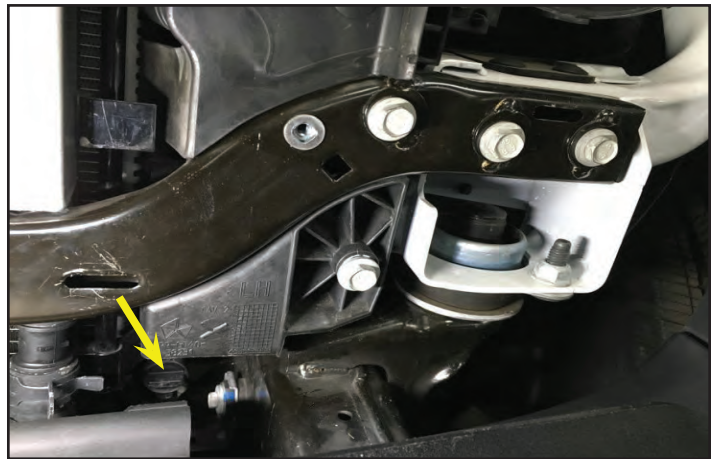

68. Now you can use the removed 3/8" VMV hose to aid in draining the coolant. Connect the hose end with the 90-degree bend to the bottom of the petcock and orient as shown. Once the drain pan is in place below the hose, un-cap the coolant reservoir and turn the petcock to open. Be sure not to turn the petcock too much as it will come out completely. Once all the coolant has drained close the petcock.



Section 5: Heater Line and Fuel Line Removal

69. Remove EGR/heater core return tube assembly. In order to do this, you must first remove the nut on passenger side bracket shown with an arrow.



70. Pry up on tab and bend bracket towards center of engine to free up the tube (yellow arrow). Remove bracket and rubber from the hardline.

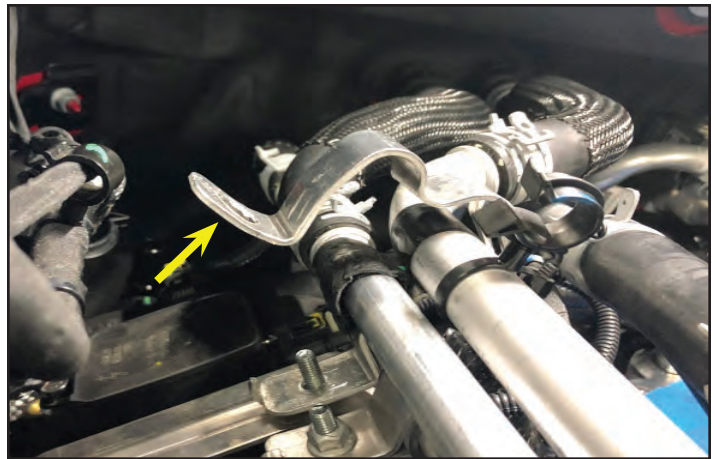

71. Remove the nut from the arrow location.



72. Pry up on the bracket shown with the arrow. Remove bracket and rubber from the hardline.

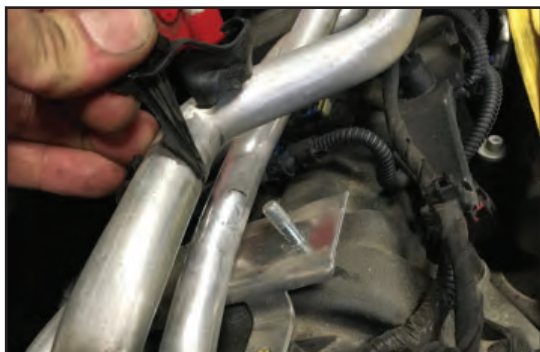

73. Thread the previously removed nut onto the exposed stud. Use pliers to support the bottom of the stud and carefully knock the stud out.

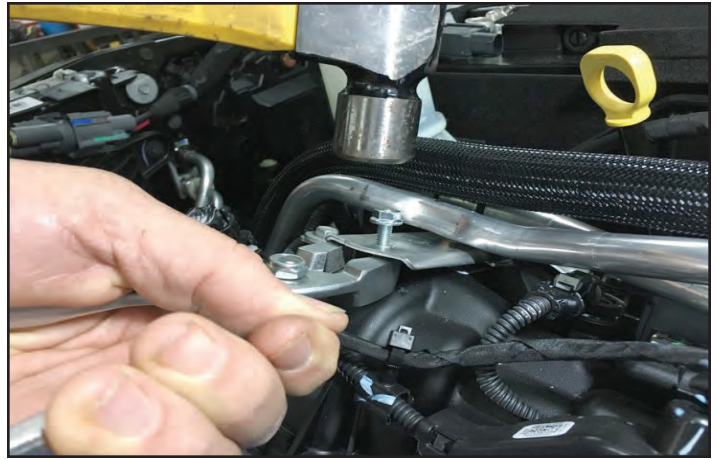

74. Remove the nut from the stud and pull the stud out from the bottom of the bracket. **NOTE: Save the M6 nut for use in a later step.**

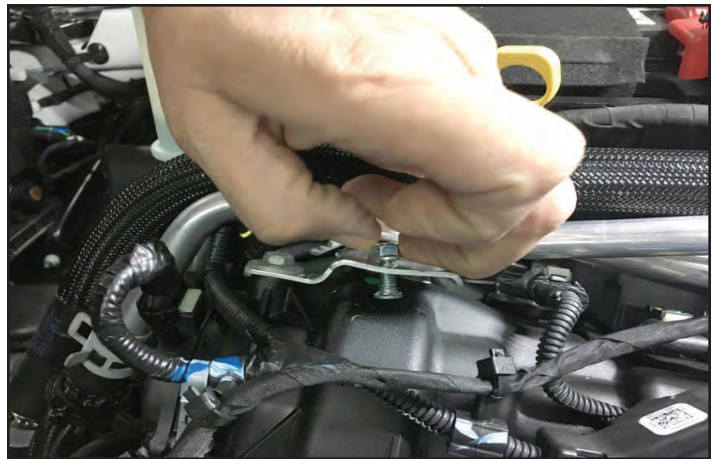

75. Cut plastic tie between heater hoses.



76. Disconnect heater hose connection at the dash panel at the arrow. The next step shows how to release this fitting.



77. The retaining clip needs to be up as shown to release.

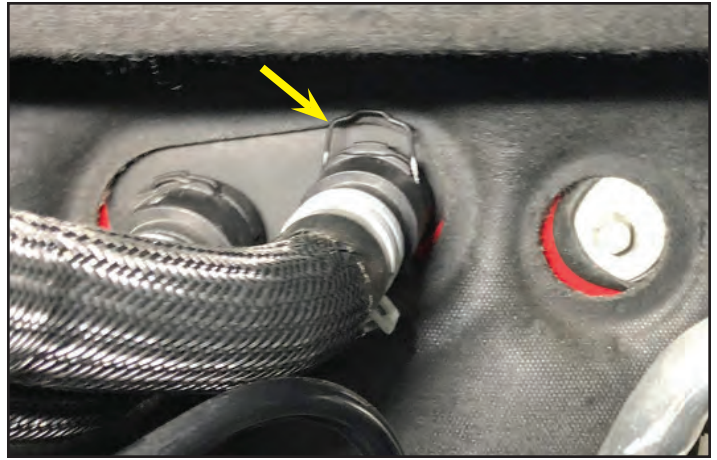

78. Disconnect the rubber hose at the location shown with a red arrow.



79. Here is the EGR hardline after removing the hoses from the last step. Disconnect the last hose shown at the arrow and remove this assembly from the car.



80. Save the hose section shown with an arrow as it needs to be reused on the new hose assembly.



81. Remove your six spark plugs. If your vehicle has less than 5,000 miles re-gap them to 0.032" and reinstall. Otherwise **replace with: NGK #6706** and verify that the air gap is 0.032" before installing them.



82. Supporting the rear EGR cooler tube with vice grips and long screw driver down the open tube end, gently swing the open end toward the fuse box (highlighted in green) in the arrow direction approximately 20 degrees to provide clearance to the new upper intake manifold.

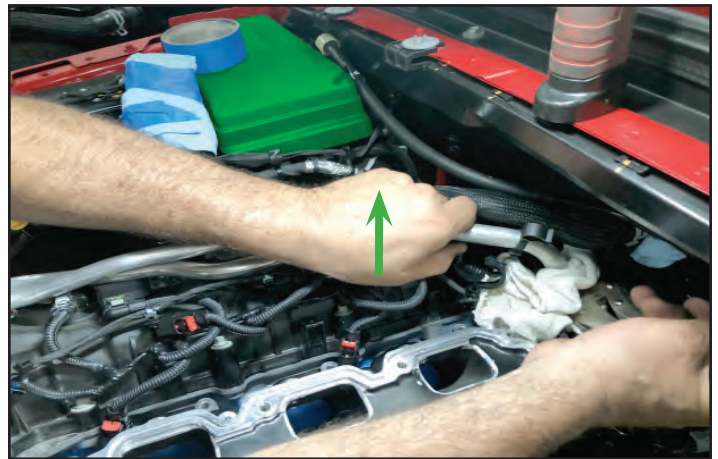

83. Remove heater quick connect fitting from stock line shown at the arrow.



84. Here is a close-up of the heater quick connect fitting being removed. Make a partial cut through the hose with a razor blade to allow the connector to be pulled loose. Do not cut the plastic hose fitting. This fitting will be reused.



85. Install clamp and quick connect fitting from the last step into the supplied hose (31-19-36-011H) at the red arrow. Install clamp and hose saved from 4 steps ago onto the fitting with the yellow arrow.



86. Place completed hose assembly into vehicle as shown. The quick connect that was installed in the last step will be installed in its original location. Remember to push down retaining clip to lock connection. The "Y" fitting will attach at the arrow location.



87. Reuse clamps and attach to the stock hose at the fitting located near the belt tensioner shown with the yellow arrow. Retain the hose assembly using the provided large cable ties in the locations shown with the red arrows.



88. **Have some shop towels ready for fuel spillage. Wear safety glasses while removing the fuel line fittings and ensure that there are no ignition sources.** Disconnect fuel inlet to fuel rail. NOTE: Remove blue locking tab, depress and pull to remove. NOTE: Be prepared to wipe any excess fuel from line and rail before proceeding.



89. Remove the 3 fuel line push pins to wiring harness retainers.

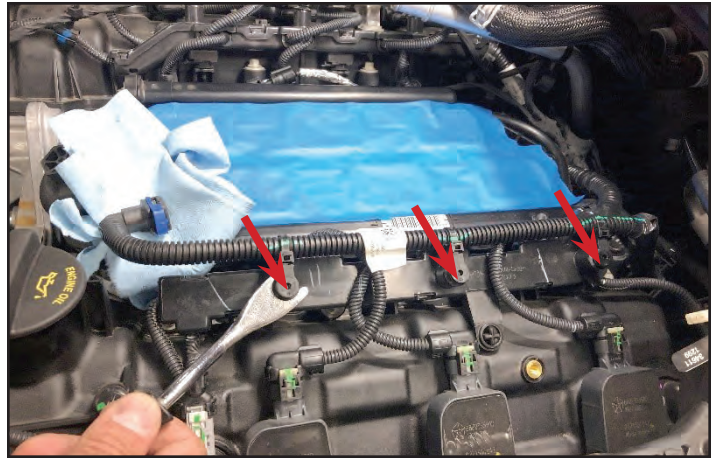

90. Remove the 3 wiring harness push pins to cam cover on driver side near injectors. Repeat process for passenger side wiring harness retention to cam cover.



91. Remove the 6 injector electrical connectors.

NOTE: Pull red locking tab up, then depress and pull to unplug connector.



92. Carefully pry apart the wiring harness retainers on driver side.



93. This is a clamshell design and will split into two pieces which can be removed from the harness. Repeat for passenger side and remove completely from the vehicle.

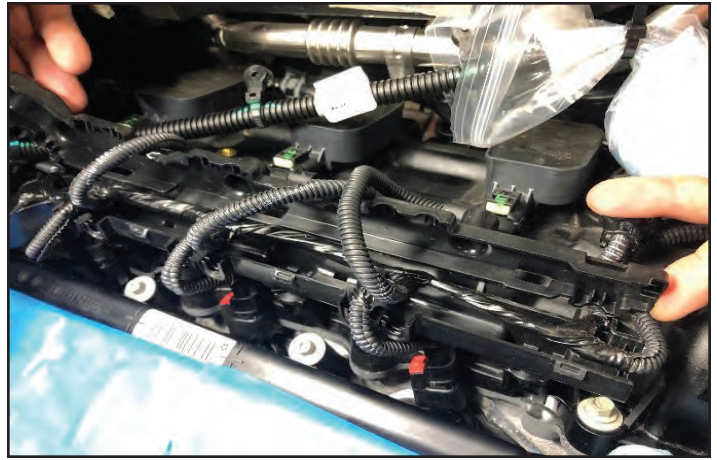

94. Remove the 3 push pins from wiring harness to rear of lower intake manifold. **NOTE: It may be easier to cut zip ties holding push pins. They will not be reused.**



95. Remove the 8 lower intake to cylinder head bolts.



96. Carefully lift the front of intake manifold to allow for access to wiring harness connected to bottom of intake. Pry push pin/retainers from bottom to allow for removal of intake from engine. **NOTE: Set intake aside in a safe place as the gaskets and fuel rail will be reused in a later step.**

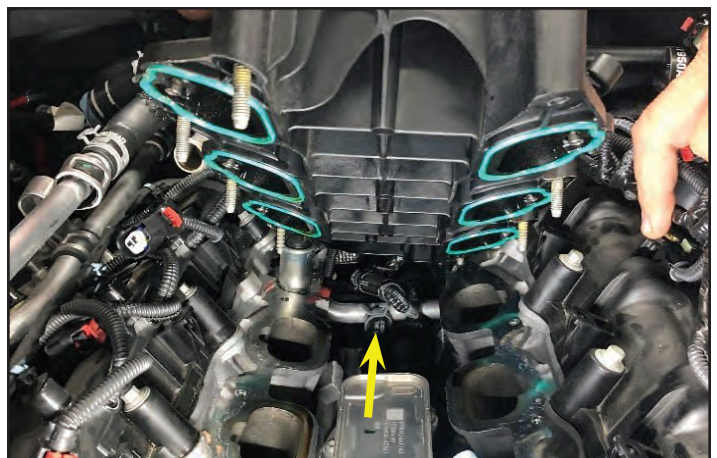

97. Using a clean cloth, carefully wipe all cylinder head mounting surfaces BEFORE proceeding. Tape cylinder head surfaces to prevent debris from falling into engine.

It is VERY important to not contaminate your work environment or allow any debris to fall into the exposed ports, or engine damage can occur.



98. Locate the Transmission vent tube clip (Near dash panel).

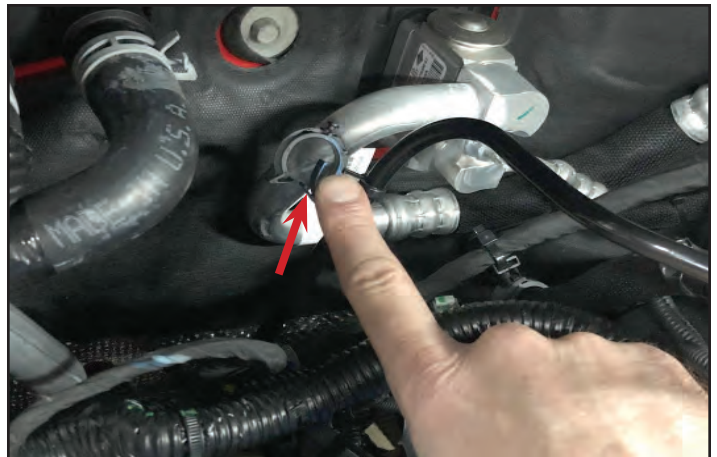

99. Clip the Transmission vent tube to the EGR cooler tube.

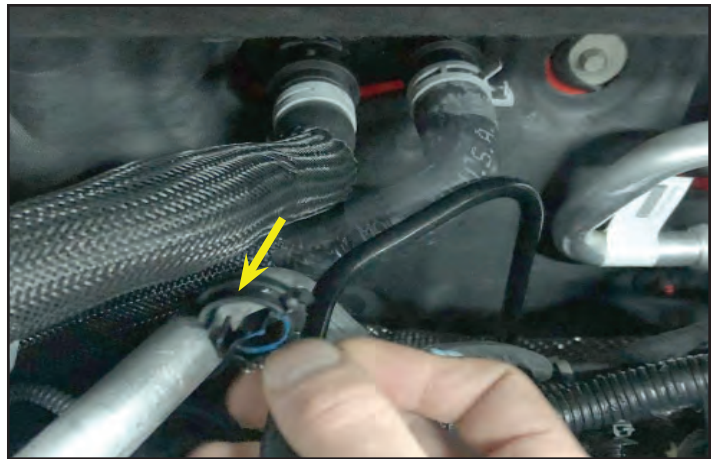

100. Route the tube from the last step underneath the injector wires & down the side of the passenger side cam cover (as shown highlighted in green).



101. PCV HOSE Modifications: Carefully remove one 90° SAE FITTING from stock tube that was previously removed.

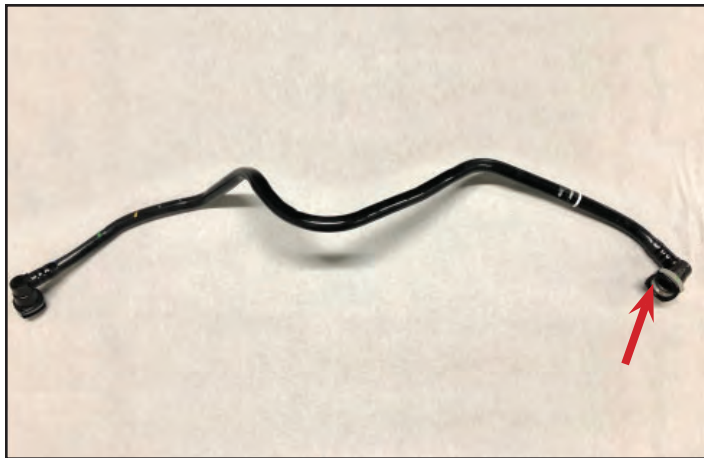

102. Here is the fitting removed in the last step.



103. Install the supplied clamp and 90° SAE fitting from the last step into the supplied 5/8" hose (31-19-36-011E) at the arrow location. **NOTE: Make sure the 90-degree connector is oriented as shown.**



104. Load hose into vehicle and connect the side with the 90° to the passenger side cam cover (rear upwards facing port). The opposite side will connect to the supercharger inlet port.



105. Route the hose from the last step down to cam cover behind engine as shown highlighted in green.



106. Here is the VMV Hose (vapor management valve). The VMV assembly created will be installed after the intake. **NOTE: The yellow paint marks show the location of the O-rings. Be extra careful not to cut them while removing the connectors.**



107. Remove 45 & 90° SAE Connectors from the stock VMV Hard line.



108. Install 45 & 90° SAE Connectors into the supplied 1/2" diameter 9.5" straight hose (31-19-36-011F) and clamps as shown.



109. Attach the 45 Degree connector to the VMV at the red arrow and the straight 3/8" diameter hose (31-19-36-011G) at the green arrow as shown.

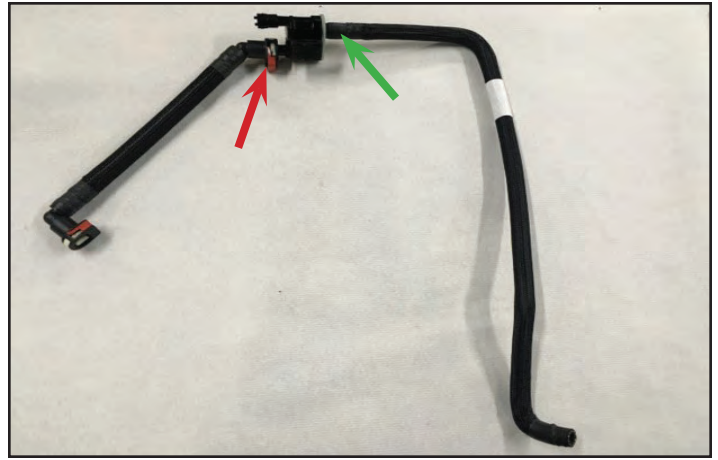

110. Install VMV Assembly from the last step into vehicle shown highlighted in green. Make connection behind passenger side cam cover shown with a yellow arrow.



111. Plug in the electrical connector to the VMV valve.



112. Route VMV hose assembly along the back of the engine and around the driver side cam cover as shown highlighted in green. This is temporary as it will be mounted to the lower intake in a later step.



Section 6: Pump Install

113. Collect the supplied coolant pump, pump bracket, rubber pump isolator, 2-M6 J-clips and M6 x 20mm bolts (not shown here).

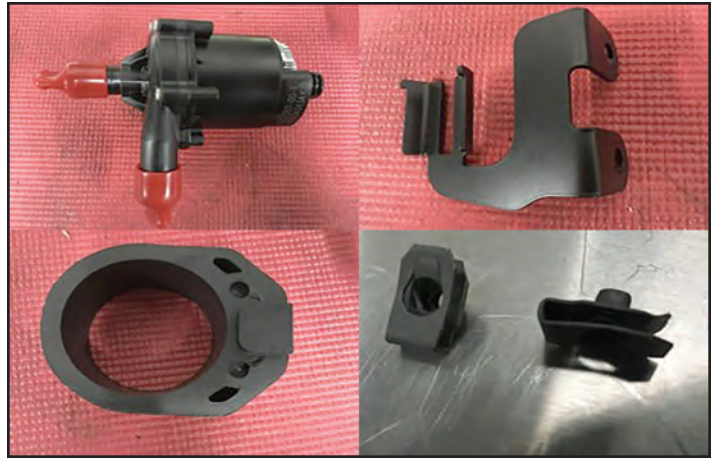

114. Locate and remove the upper wire retainer behind the driver side front wheel. (yellow arrow)



115. Install the J-clips onto the upper two tabs. Install intercooler pump mounting bracket to the tabs with the J-clips using two M6 bolts (10mm socket).

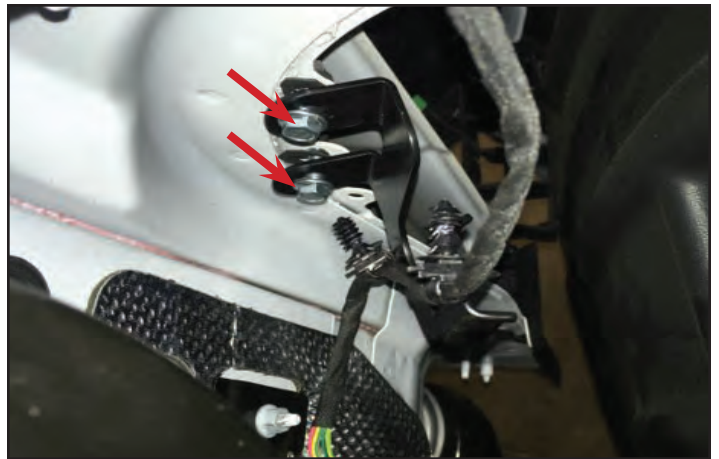

116. The pump should come with the rubber mount pre-installed in the orientation shown. Ensure that the stop hits at the arrow location.



117. Install pump onto intercooler mounting bracket.

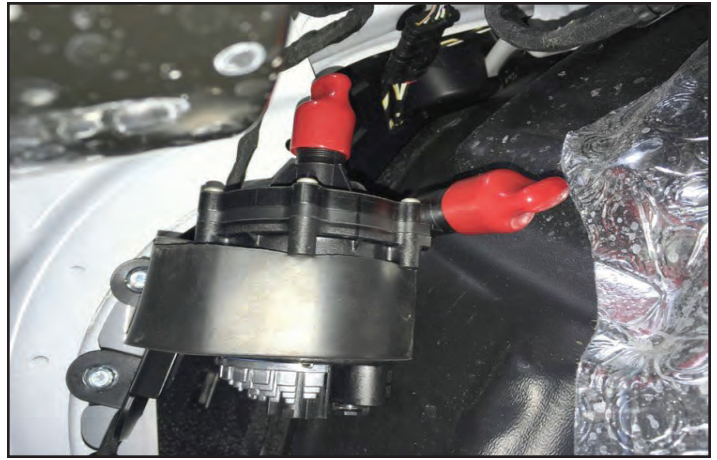

Section 7: Wiring

118. Gather the supplied Intercooler Pump Harness shown.



119. Make a small groove in fuse box at the arrow location to allow the yellow trigger wire to pass through.



120. Connect the eyelet terminal for the power wire on the intercooler pump harness on the bus as shown (red arrow) using the M6 nut saved from the OE Heater Tube removal. Pull fuse #F04 - fuel pump 20A (yellow arrow).

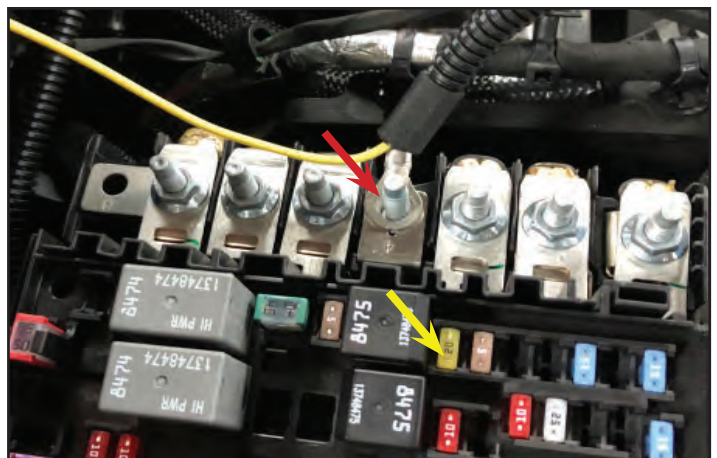

121. Install fuse spike that is on the yellow trigger wire (highlighted in green) on the 20A fuse that was removed in the last step.

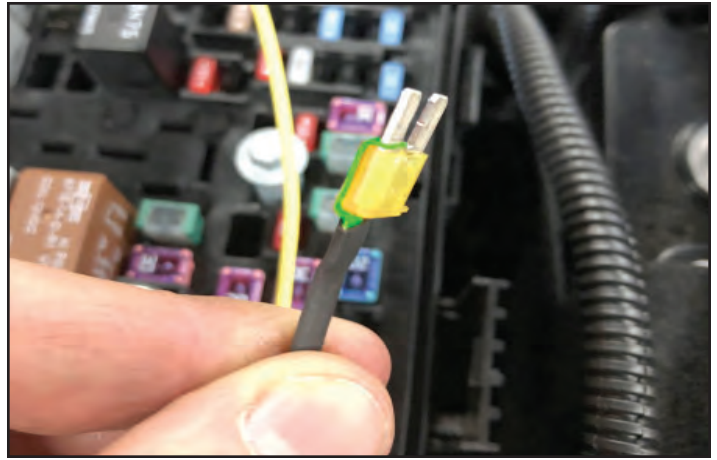

122. Reinstall the spiked fuel pump fuse (#F04) and carefully route the wire through the notch (red arrow location) as shown to prevent damage from the fuse box cover.

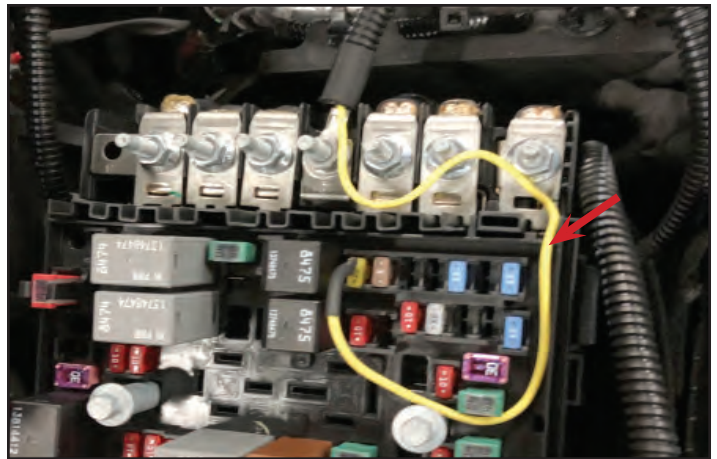

123. Carefully reinstall fuse box lid and make sure not to pinch any wires.



124. Route ground wire down along the front of the fuse box but **do not** connect to stud until a later step.

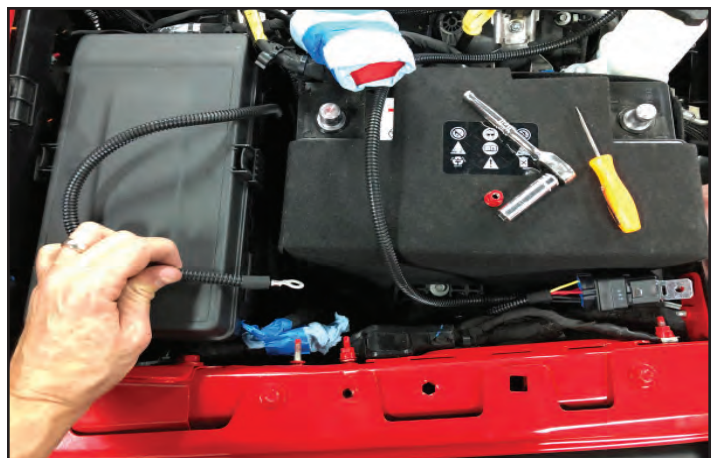

125. Install the provided 15 Amp fuse for the I/C harness into fuse housing.

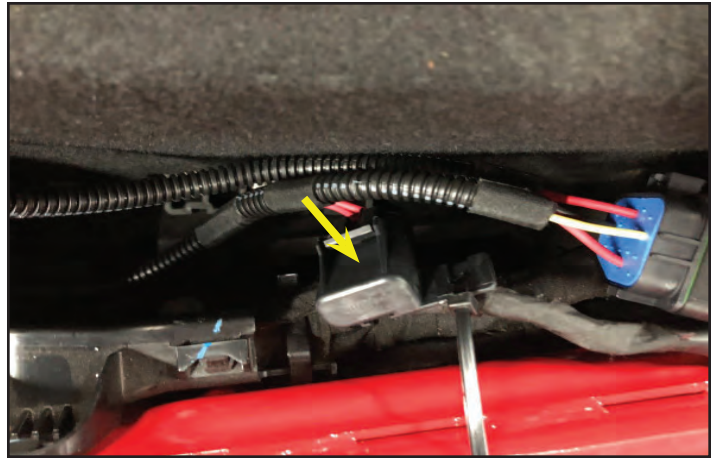

126. Tuck fuse housing neatly under the relay. This will be mounted later.



127. Route intercooler pump wiring around the fuse box, along rear of engine.

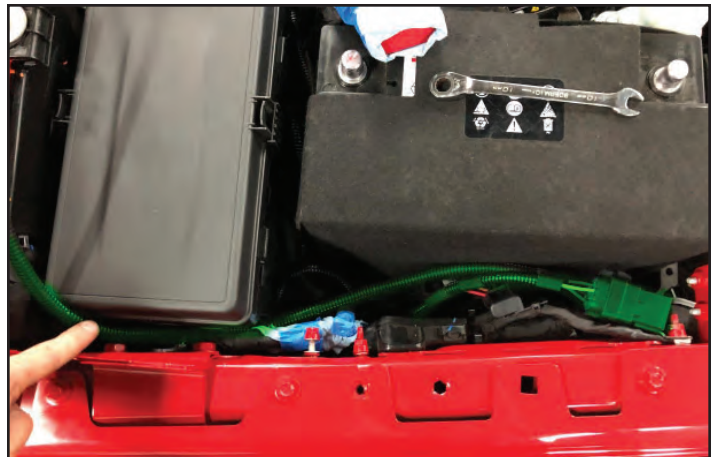

128. Continue routing the wiring around the back of the fuse box at the arrow location.



129. Route connector behind degas bottle mounting bracket, shown with the arrow, and over brake booster to the pump.

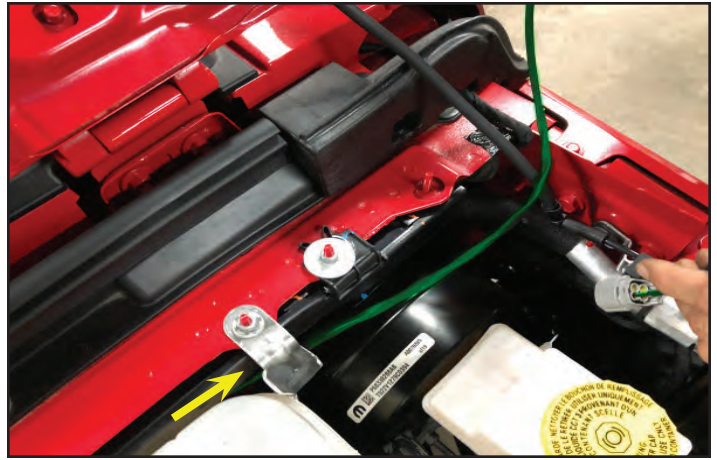

130. Route the connector down to the intercooler pump and make connection at the bottom of the pump.



131. Connect the MAP sensor wire extension harness to the existing MAP sensor plug. The location of this plug will be shown in the next step.
NOTE: Each side of the MAP sensor connection has an offset, the offsets are on opposite sides from each other! The locking clip will only engage the tab if you align the offsets correctly. You can force the connection with the offsets being on the same side, but in the process you can damage the connectors. ENSURE THE OFFSET OF THE MAP SENSORS ARE ON OPPOSITE SIDES AS SHOWN IN THIS IMAGE.

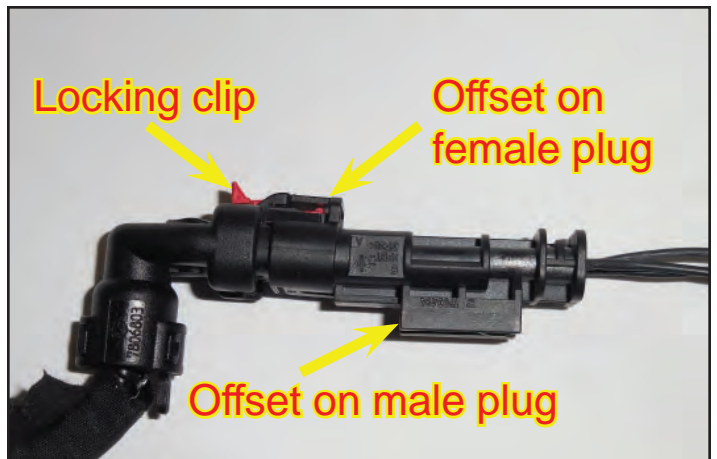

132. Install MAP sensor extension harness highlighted here in green. Connect the harness female end with OE male end. Note: MAP harness connector plugs where OE sensor was disconnected earlier. **Ensure that you engage the locking clip shown in the last step once the connection is made.**



133. Gather the provided IAT sensor extension harness.



134. Install IAT sensor extension harness. Connect the female connector from the harness with the OE male connector shown at the arrow location. Note: IAT harness connector plugs where OE sensor was disconnected earlier. The opposite end of this IAT sensor extension will be plugged in later.

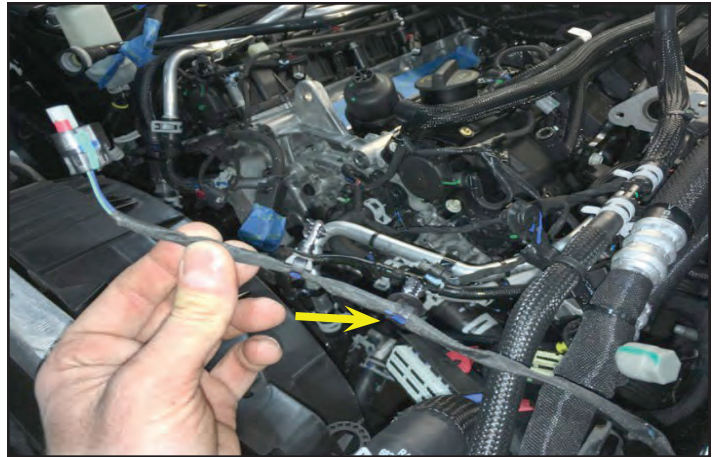

Section 8: Horn And Ambient Air Temp Relocation

135. Remove 2 front pencil braces highlighted in green (4 bolts).

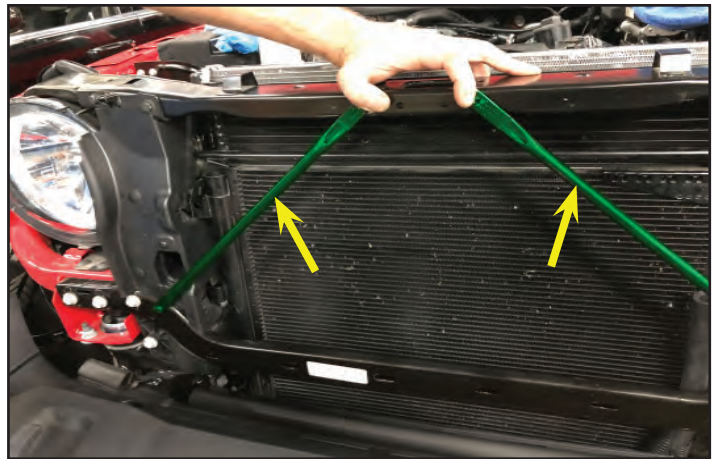

136. Remove both side front closeout panels highlighted in green. **NOTE: The passenger side closeout has two T20 Torx bolts to mount the OE air inlet duct.**

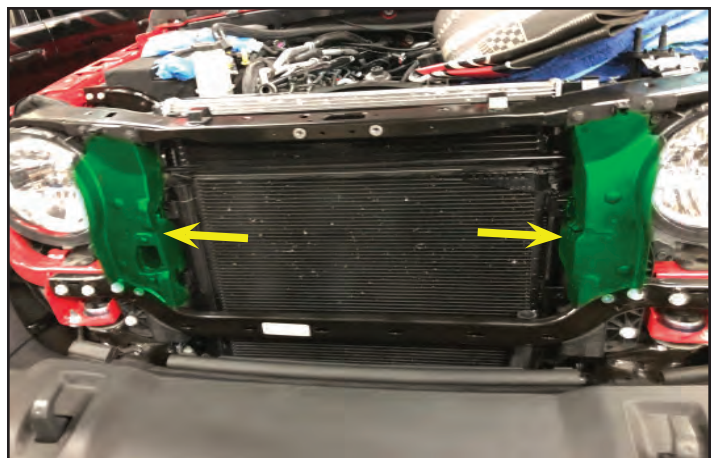

137. Loosen 2 cooling module retaining bolts.

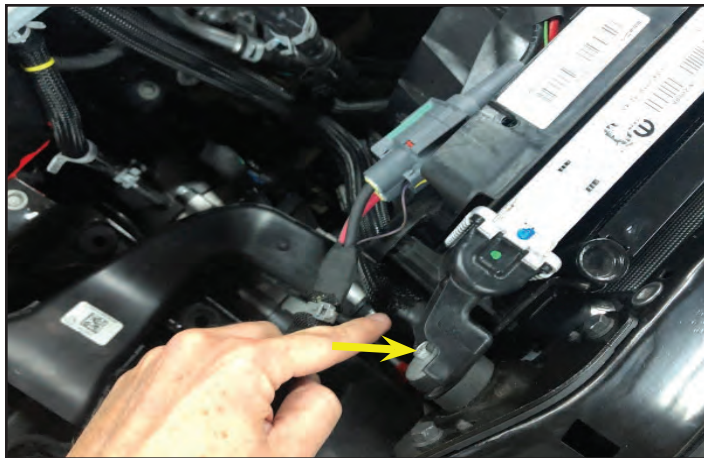

138. Push the top of the cooling module toward engine at green arrow to provide clearance for the removal of the horn bracket bolts shown at the yellow arrow.

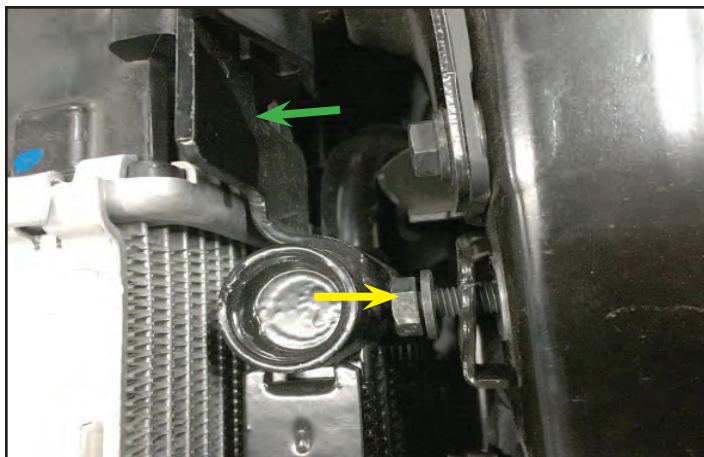

139. Start by removing 3 electrical connections. To remove the horn electrical connectors, first pull up on the red locking tab (red arrow) and then depress the tabs under the red locking tab (yellow arrow) and gently pull to remove.

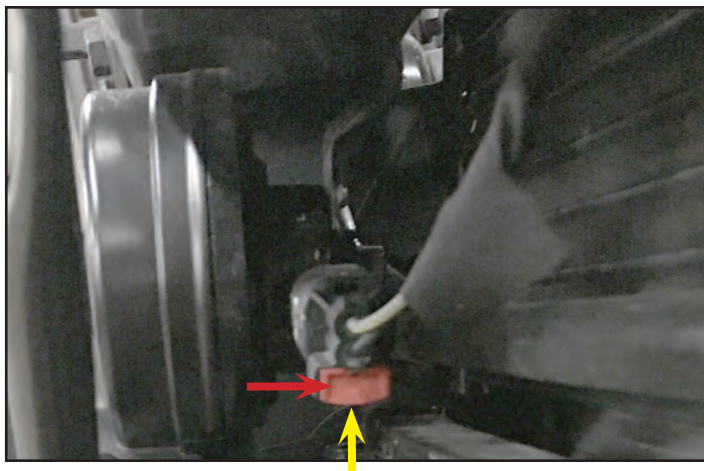

140. Remove horns and brackets from the vehicle at yellow arrow locations. Remove ambient air temp (AAT) sensor as well at green arrow location.

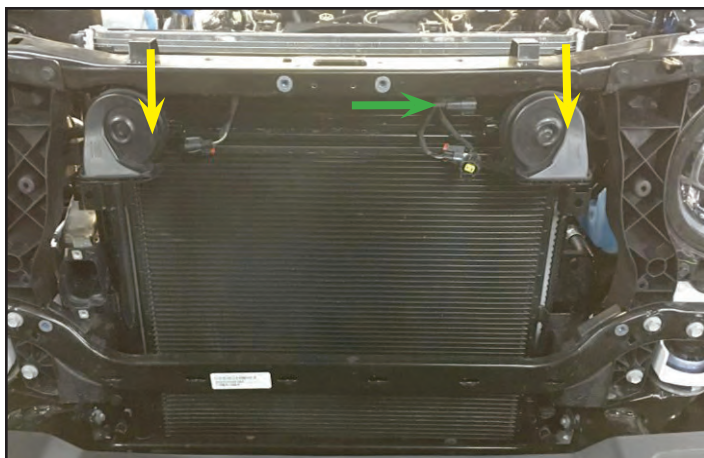

141. Remove the 4 push pins that retain the wire to the radiator support. (Only 3 shown in picture)

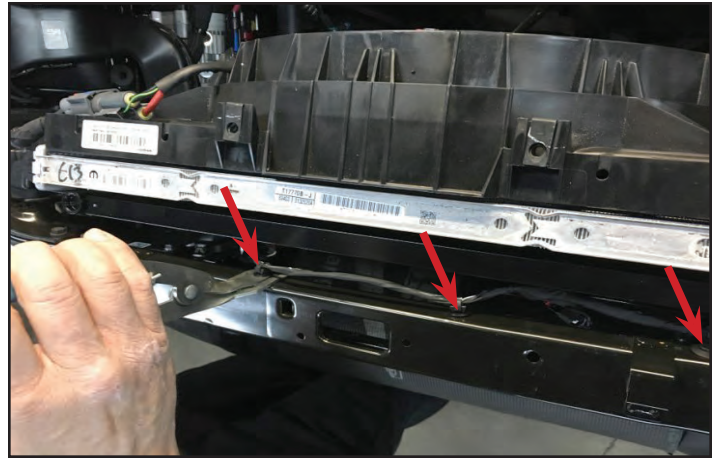

142. Carefully remove approximately 4" of OEM tape from the yellow highlighted area of the horn/AAT wiring harness to expose the common ground for the horns and the sensor. (This will be as far as the harness can be split) When the modification is complete there will be enough harness length to relocate the AAT sensor. **Make sure to re-cover the exposed wire with heat shrink or electrical tape before proceeding.**

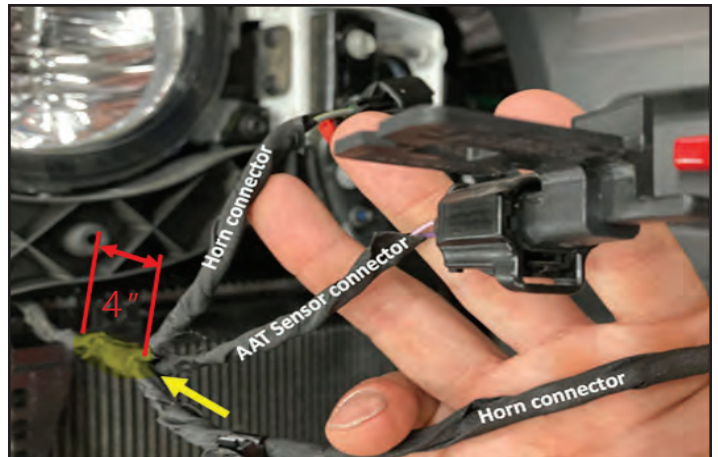

143. Re-route horn/AAT wiring harness from stock location, highlighted in green, back into the area of windshield washer fluid reservoir. **Note: Horns shown in place for clarity. These will not be installed until a later step.**

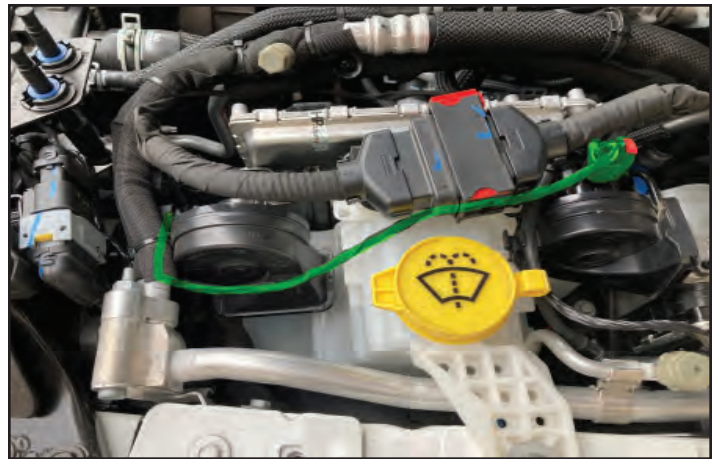

144. Route the AAT sensor wire with the sensor installed to the inside of the grille opening as shown. This sensor will be installed on the driver's side closeout panel in a later step.



145. Push the cooling module back into place and tighten 2 mounting bolts.

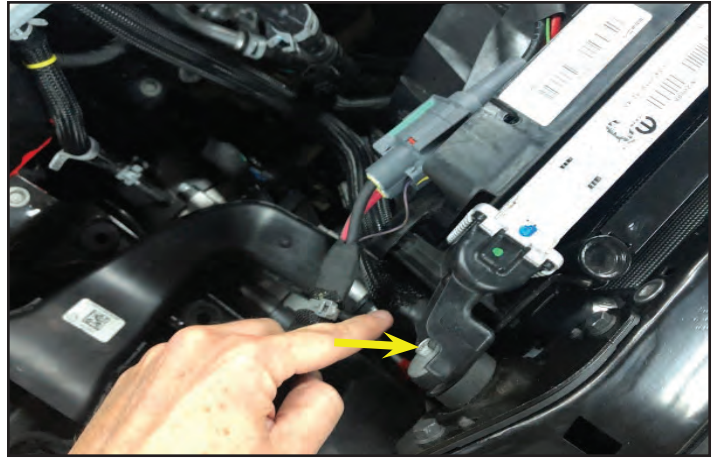

146. Use a 1/4" drill to increase the size of 2 existing unused holes in PCM mounting bracket. This photo shows the forward hole location.

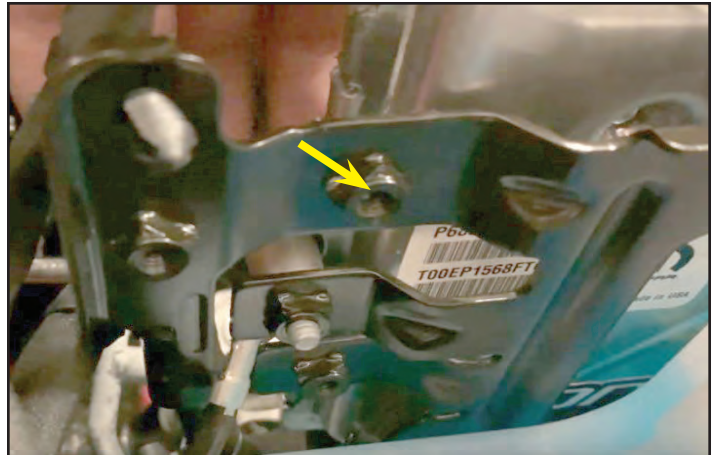

147. This photo shows the rear hole location for the relocation of the horns.

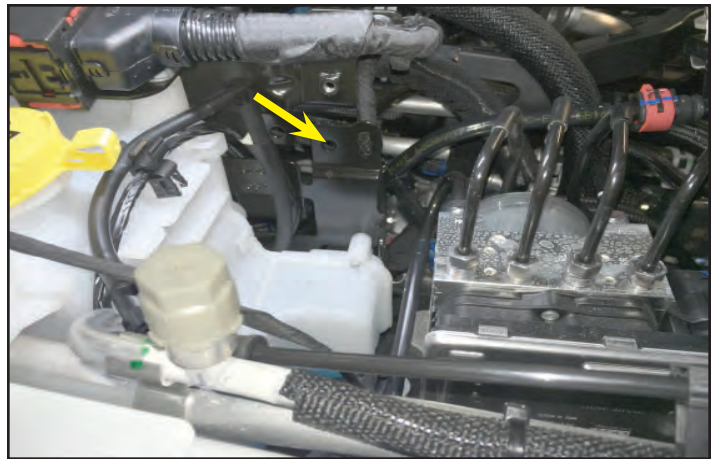

148. Remove stock horn mounting brackets from horns. These will not be reused. Install 2 tall hex nuts onto back of horns and **tighten to 89 in-lbs.**



149. Install horns using two M6 bolts, thru PCM bracket and into hex nuts. Orient horns as shown. **Tighten to 89 in-lbs.** Reconnect horn wiring connectors.

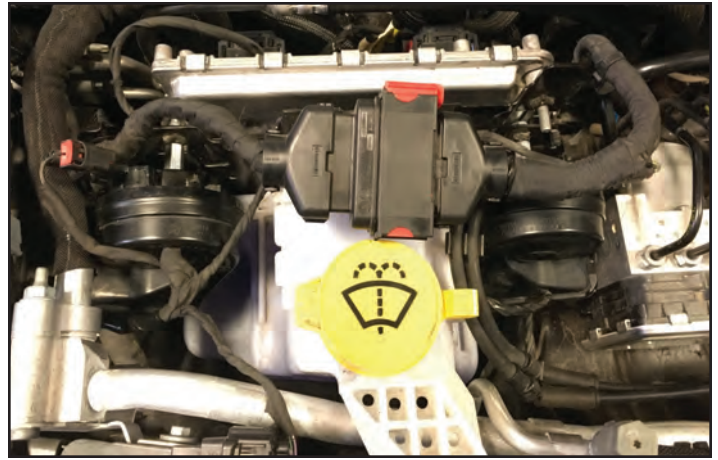

150. Once you have received the PCM back from getting unlocked you will reinstall the bolts. **VERY IMPORTANT: Be sure to re-attach the PCM ground strap between the PCM and the bracket when installing the front bolt.**

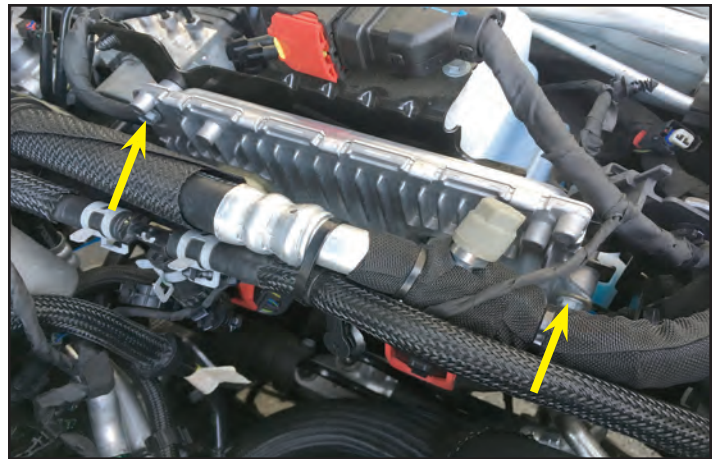

151. Plug the connections in for the PCM and secure the two clamps.

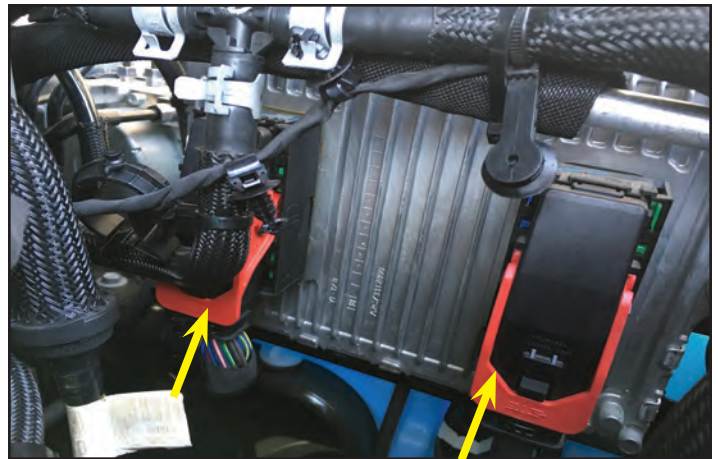

Section 9: I/C Hose Installation

152. Here you can see the hose diagram for the intercooler system. These hoses will be connected over the next steps. You will find a larger version of this diagram at the back of this manual.

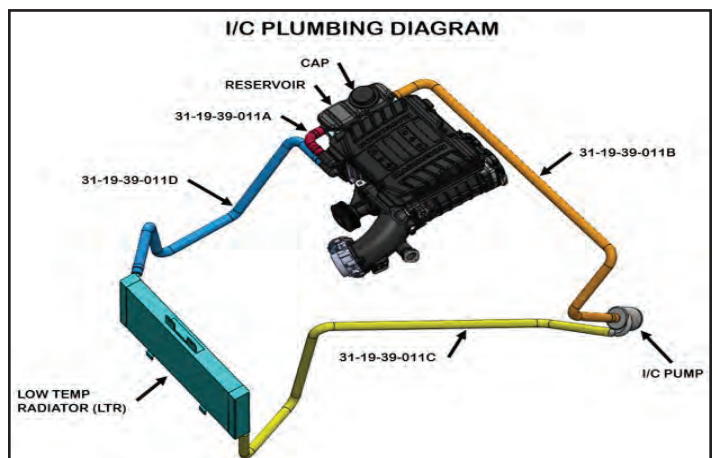

153. Remove the fan wiring harness push pin from the cooling module in the arrow locations shown in the two photos here.



154. Cut off the pin that was just removed in the last step.



155. Cut fan shroud tang used to mount the push pin removed in the previous step. Once removed, this area will allow for clearance of an intercooler hose. Make sure the plastic is smooth once tab is removed



156. Locate the supplied 3/4" formed hose 31-19-36-011D shown here.

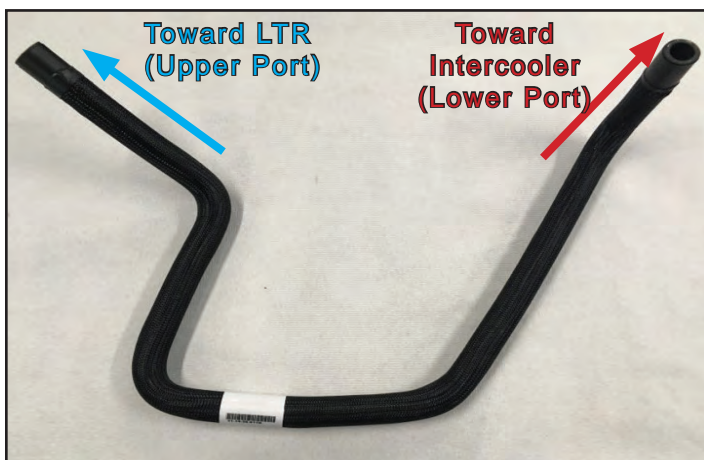

157. Route intercooler hose: 31-19-36-011D through the opening created by removal of the tab in the previous step. Gently push the hose (highlighted in green) from inside the engine compartment, you may need to push the hose farther through to help make the clamp connection at a later step.

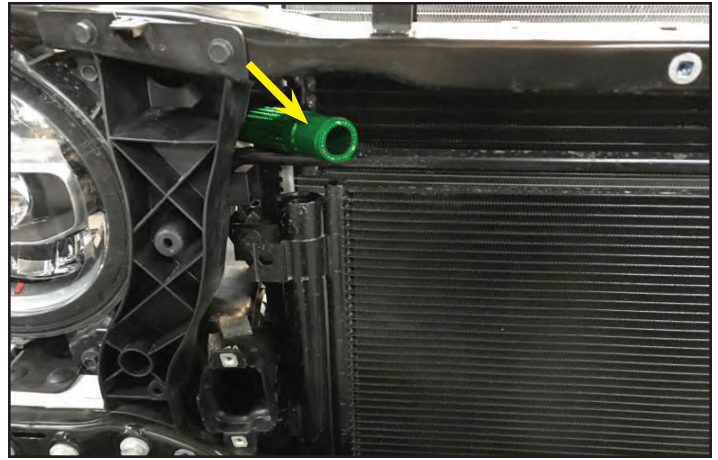

158. The green highlighted hose: 31-19-36-011D will route as shown so that the airbox will be able to be re-installed later without crushing the intercooler hose. Place the end in a safe place until a later step when the connection will be made.



159. Here is another view of the hose 31-19-36-011D routing up to the radiator.



160. Locate the supplied 3/4" formed hose 31-19-36-011C shown here.

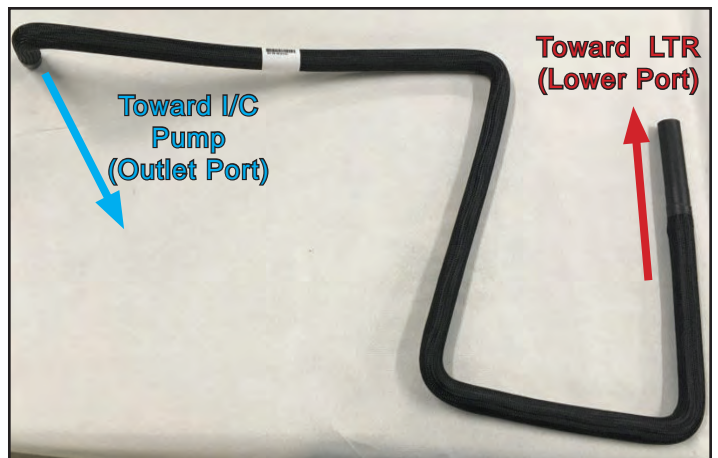

161. Install the clamp and intercooler hose: 31-19-36-011C to the intercooler pump outlet.

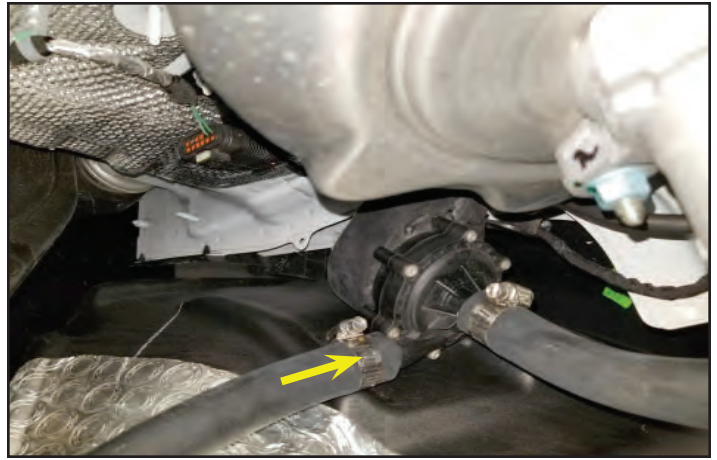

162. Route 31-19-36-011C (highlighted in green) from the pump forward along the frame rail between the ABS lines and the inner fender well.



163. Route hose 31-19-36-011C over the upper radiator hose and down through the gap shown by the arrow. (just in front of the steering stabilizer bar.)

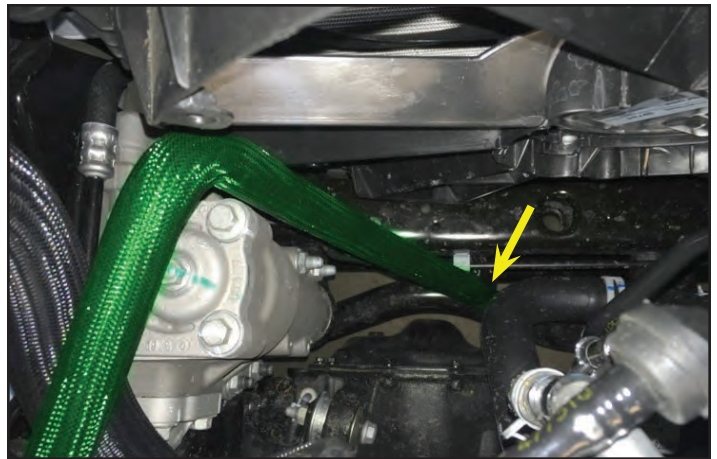

164. Continue routing of 31-19-36-011C under the front suspension sway bar and the bottom of the cooling module toward the front. The last turn routes up to the position of the lower port of the LTR. Apply a small amount of lube on the inner diameter of the hose to ease the install later.



Section 10: Install Low Temperature Radiator (LTR)

165. Loosely place the LTR in position with the two lower brackets engaged with the lower horse collar.



166. With the two lower LTR brackets engaged to the lower horse collar, rock the LTR up on the driver side to allow access to the lower hose port. Make sure to position the worm clamp onto the hose so that you can access the screw from the front. This will also allow the assembly to sit back down with proper clearance between the clamp and the horse collar as well as the A/C condenser behind.



167. Rock the LTR back down until both lower mounting brackets are properly engaged with the horse collar. It is very important to make sure the worm clamp is positioned with the screw facing forward on the outboard side of the lower LTR port. This will also allow the assembly to sit back down with proper clearance between the clamp and the horse collar as well as the A/C condenser behind.



168. Gently pull out on the top of the LTR to allow access to the upper port. Make sure to position the worm clamp onto the hose as shown. After the connection is tight, push the LTR back into position making sure to adjust the upper hose: 31-19-36-011D as well to ensure the proper routing / avoiding pinching the hose.

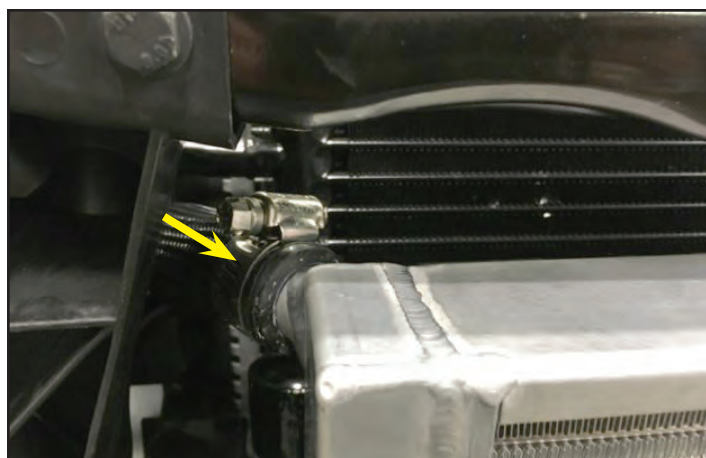

169. Reuse two OE front strut bolts to finish installing the LTR.



170. Ensure that the side closeout panels have been reinstalled using 2 push pins on each side plus 2 bolts to inlet duct using Torx T20 driver. When this is completed, we recommend that you cover the LTR with a thick blanket or cardboard to avoid accidentally damaging the LTR fins while reaching into the engine compartment to install the remaining components.



171. Attach the AAT sensor to the vehicle using the upper pushpin on the driver's side closeout panel as shown at the arrow location.

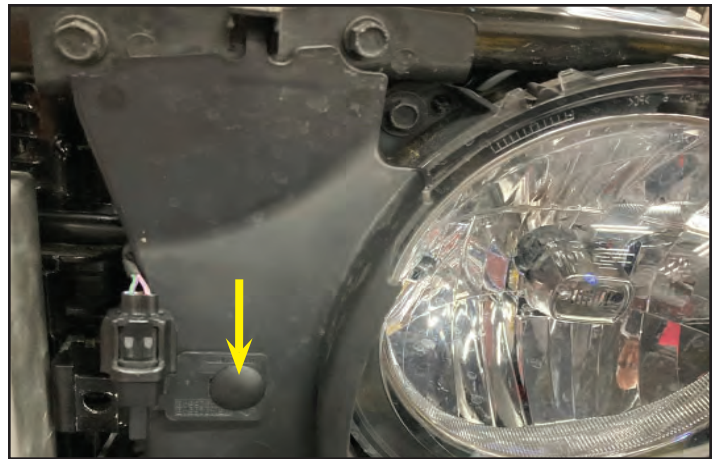

172. Locate supplied 3/4" formed hose 31-19-36-011B shown here.

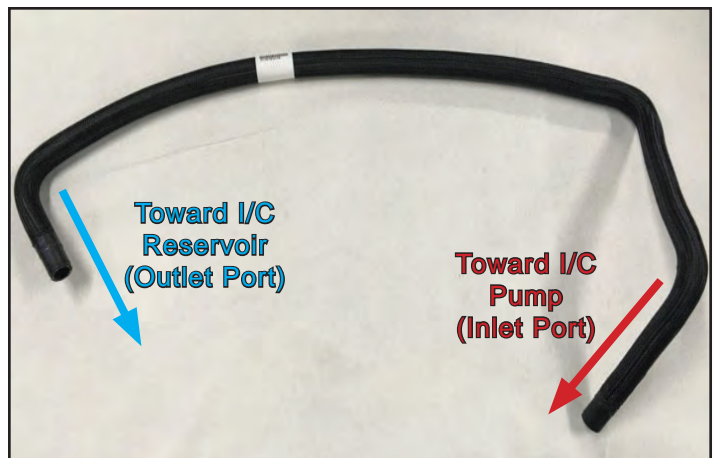

173. Connect intercooler hose: 31-19-36-011B to intercooler pump INLET with a provided clamp.



174. Route intercooler hose: 31-19-36-011B along dash panel under brake booster & behind OE coolant reservoir in the arrow location.
NOTE: If the reservoir is pinching the hose. Use some pliers to roll the edge of the bracket to create the appropriate clearance.



175. Here you can see the path of the hose from the last step behind the engine highlighted in green.



Section 11: Lower and Upper Intake Preparation

176. Locate both the steel and aluminum rear support brackets, 3X-M6 x 20mm bolts, 4X-M8 x 20mm bolts as shown.

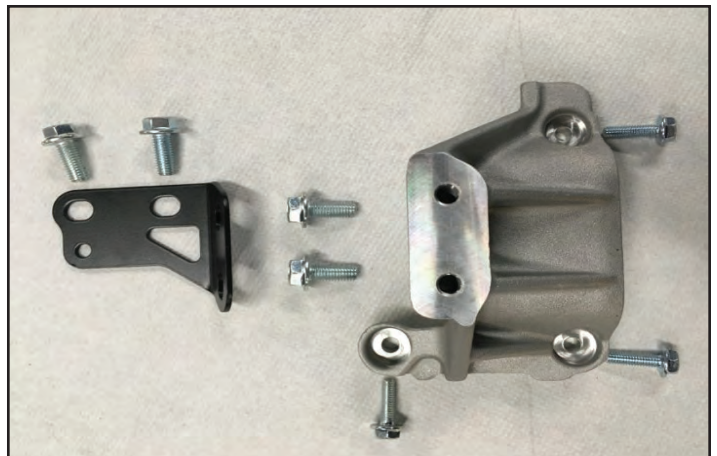

177. Install Rear Lower Support Bracket into place on the three threaded inserts on the driver side cam cover. This bracket is shown in the next step.

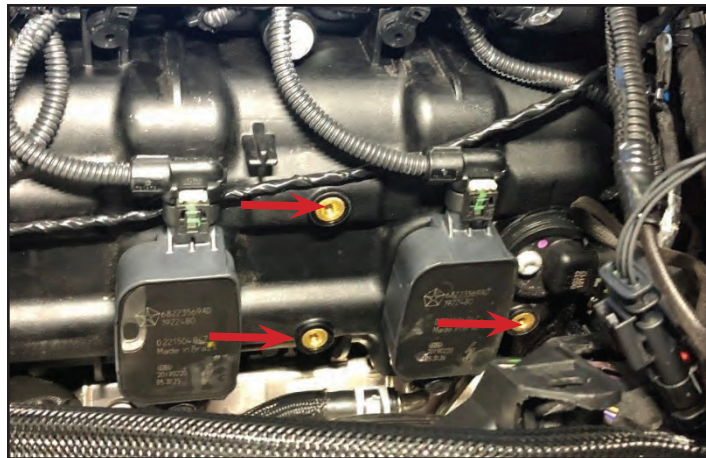

178. Here is the Rear Lower Support Bracket in the location from the last step. Using a 10mm socket, install the bracket to cam cover using the 3-M6 x 20 bolts. **Tighten bolts to 88 in-lbs.**

NOTE: To gain better access to the bolts, temporarily unplug the EGR tube sensor (red arrow) and carefully pull the plastic covered wire bundle up and over the sensor toward the driver side as shown in the picture (yellow arrow).

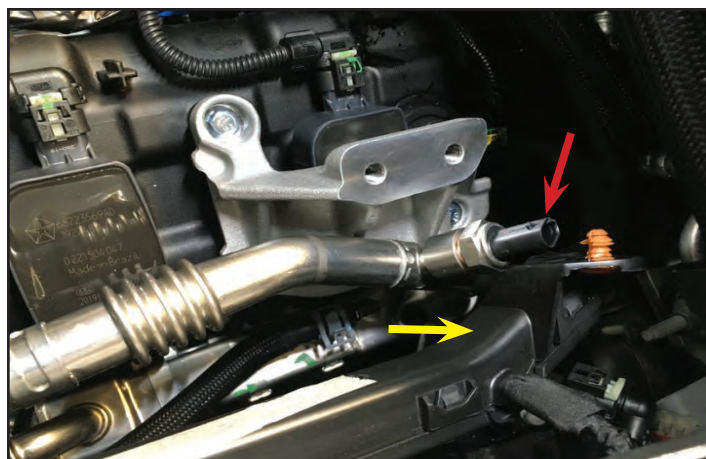

Have some shop towels ready for fuel spillage. Wear safety glasses while removing the fuel line fittings and ensure that there are no ignition sources.

179. To remove the OE Fuel Rail assembly, use T30 Torx to remove the 4 bolts. Then gently pull up to release the rail and injectors from the OE Lower Intake Manifold.

NOTE: Be prepared for fuel spillage - the Fuel Rail will still have some fuel inside.

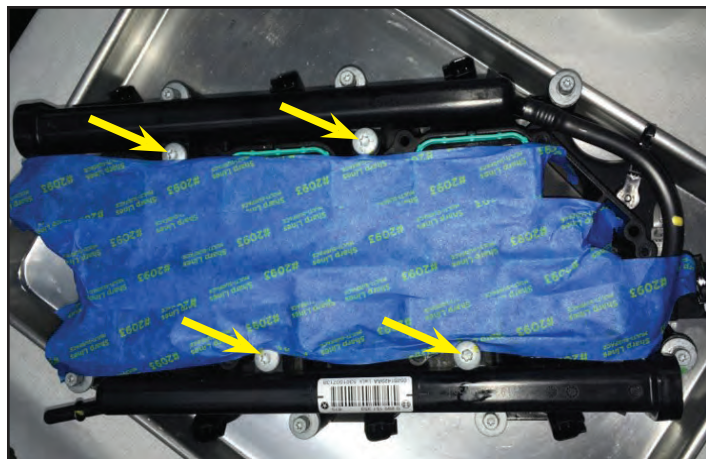

180. MAGNUSON Lower Intake Manifold subassembly:

Carefully unwrap the Lower Intake Manifold with pre-installed gasket. Also gathering the supplied Lube, 6 - upgraded Fuel Injectors, the OE Fuel Rail and 4 – M6 x 35mm bolts (bolts not shown in picture)

NOTE: Be careful not to cut or damage the Intake Gasket while unwrapping or during assembly.

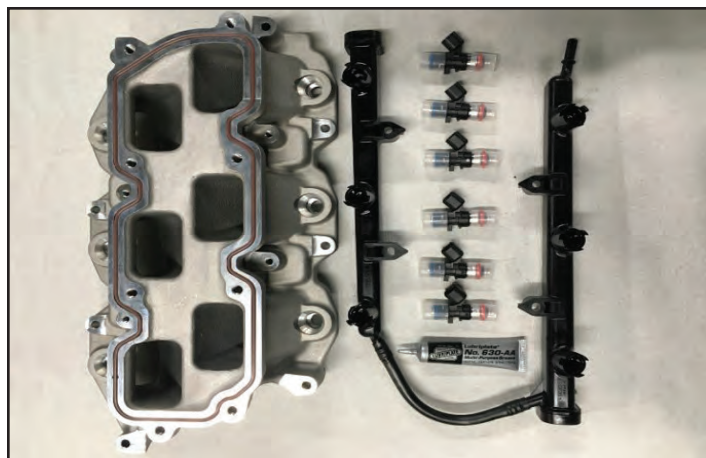

181. Install Supplied Fuel Injectors into OE Fuel Rail using lube on the O-rings to prevent damage and ease the installation process.



182. Reinstall stock fuel rail onto Magnuson Lower Intake Manifold. Use 4 supplied M6 x 35mm bolts and **torque to 89 in-lbs.**



183. Here is a top view of the fuel rail location. **NOTE: The Fuel X-Over line will be around the rear of the Lower Intake Manifold as shown for proper Fuel Rail orientation. (red arrow)**



184. Remove 6 OE Intake Manifold Gaskets from the OE manifold and install in the Magnuson lower manifold shown below.



185. Cover the top surface of the completed Magnuson Lower Manifold Assembly with tape (shown in the next step) and remove the tape from the Engine Cylinder Head surfaces. **Ensure that all wires are clear from this area prior to installing the Lower Intake Manifold.**



186. Install completed Lower Intake Manifold Assembly onto the engine. Hand tighten fasteners:
 Four M6 x 40mm bolts are used on the inner bolts.
 Four M6 x 60mm bolts are used on the corners.



187. Use this image to sequence the torquing of your lower intake manifold mounting bolts. Do NOT torque each bolt down to full specs in a single step. Rather gradually bring each bolt up to specifications rotating in this pattern. The final **torque should be 106 in-lbs**. There is a larger version of this diagram at the back of this manual.

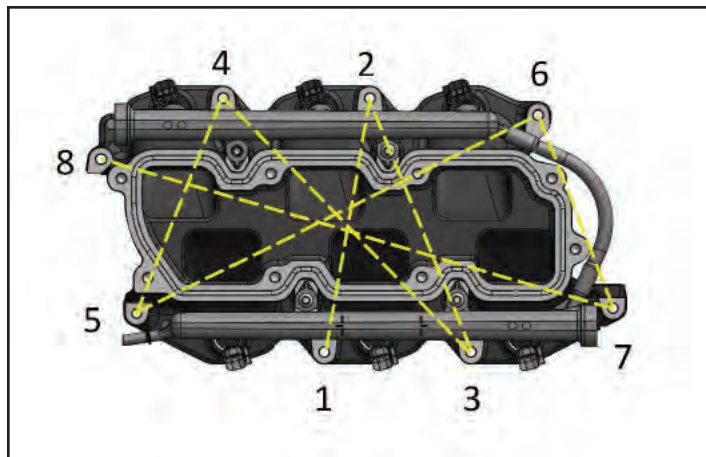

188. Plug in 6 injector connectors and depress red locking tab.



189. Reconnect the Fuel supply Line to the Fuel Rail. Make sure to route the line as shown and engage the blue lock to ensure connection.



190. Carefully manage all wiring down between fuel rail and cam cover to provide clearance to the upper intake and supercharger which will be installed in later steps.
NOTE: Reuse the push pins on the Fuel Supply line to retain it to the cam cover. This will insure it is tucked in next to the driver side Fuel Rail (yellow arrows). Also make sure the PCV line is tucked in along side the passenger side Fuel Rail (Green arrow).

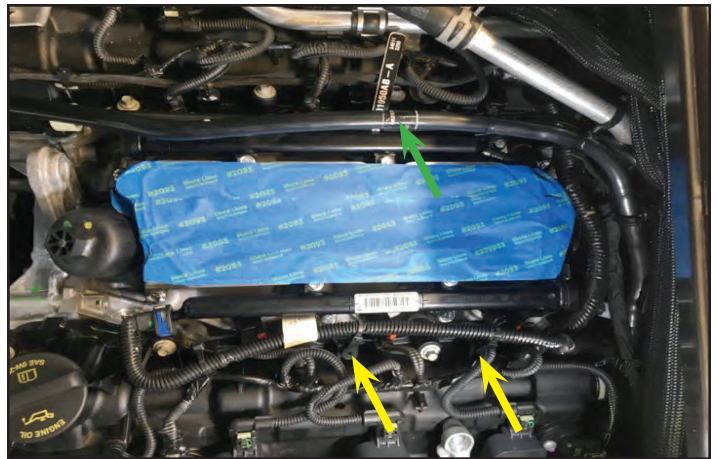

191. Carefully unwrap the Magnuson Upper Intake Manifold Subassembly.



192. Remove the Turret Manifold Assembly by removing the four M6x35mm bolts using a 10mm socket. Save these bolts for re-use. Carefully pull the Turret Assembly straight out to disengage the Intercooler Tubes.

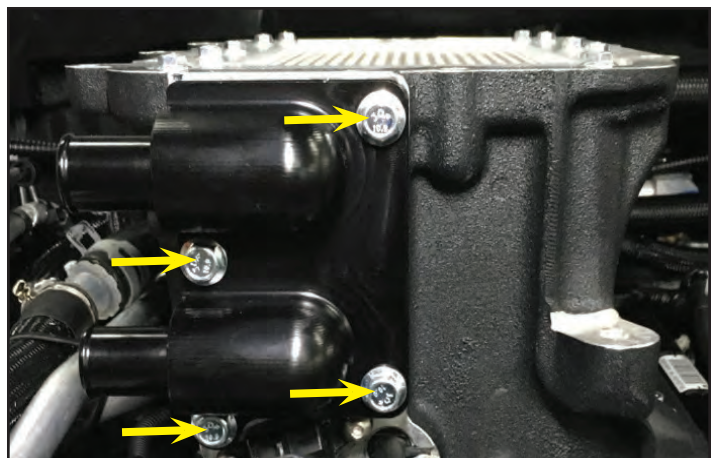

193. Remove Intercooler Tubes by carefully pulling them straight out. (If the Intercooler Tube(s) came out with the Turret Assembly, remove the tube from the Turret.)

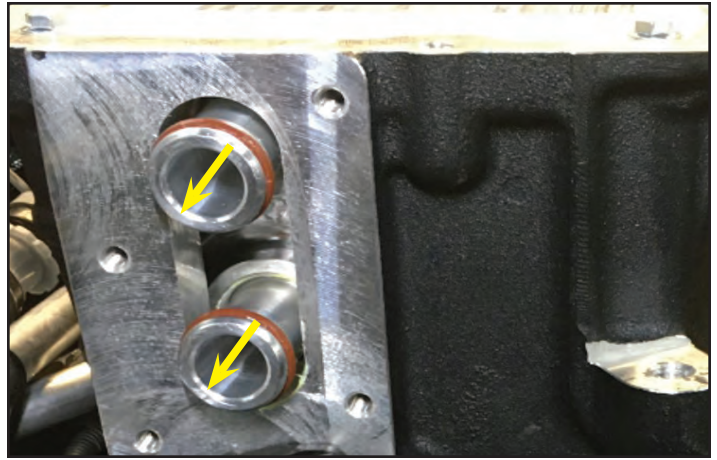

194. Remove the 10 intercooler mounting bolts. (save bolts for re-use)

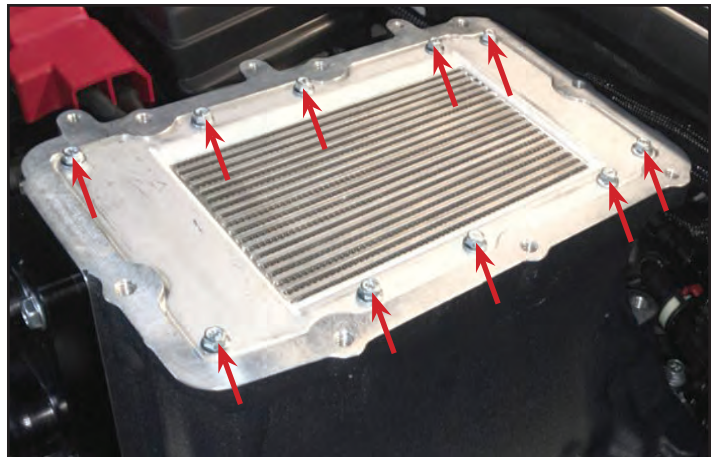

195. Remove the Intercooler by pushing up with your finger on the Intercooler inlet (red arrow). This will allow you to get under the mounting flange. Carefully pull the Intercooler straight out and put in a safe place until needed.



196. Install the IAT sensor that was removed from the stock clean air tube in a previous step in the red arrow location using lube and secure it with one provided M5x10mm bolt. Using lube, carefully install the supplied 2 Bar MAP sensor into the intake and secure using two internal hex head M5 x 16mm bolts at the yellow arrow locations. **Torque all three M5 bolts to 53 in-lbs.**

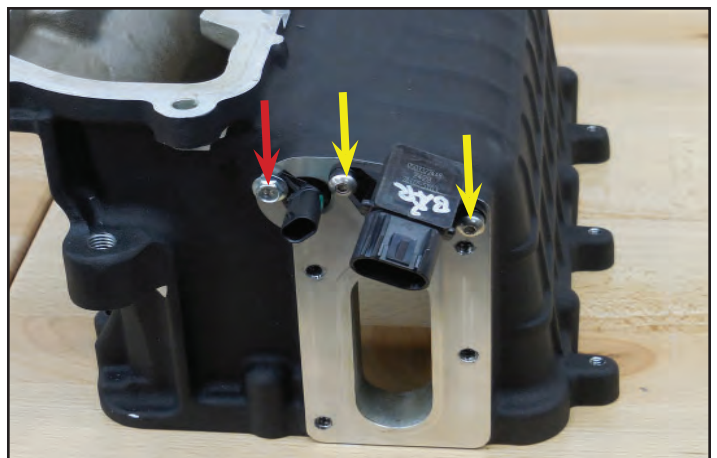

197. **Optional Step:** If you wish to add a boost gauge you will have to remove the threaded plug at the red arrow location and replace it with a 90° fitting like the barbed one shown here. Clock this fitting as shown and attach the hose before installing the upper manifold in the vehicle. This location will be at the back of the engine bay near the firewall which makes it impossible to access once the manifold is installed. **DO NOT forget to connect the gauge if you follow this step!**

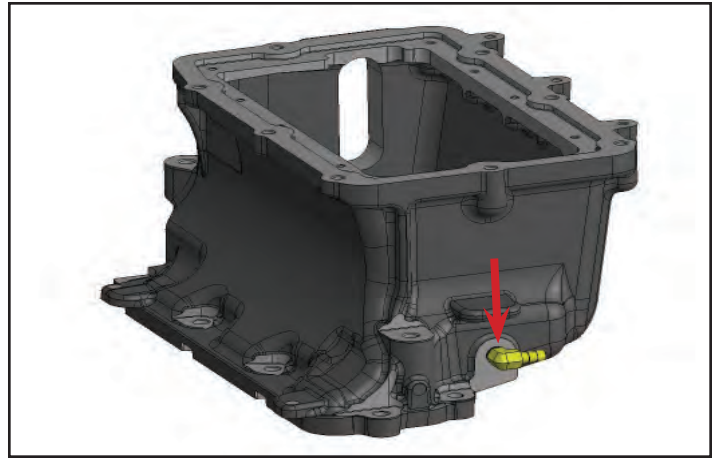

Section 12: Main Installation

198. Remove the tape from the lower manifold shown below. Place the upper intake on lower.



199. You may need to make small adjustments to heater formed line to provide small clearance and allow the intake to align correctly.



200. **Apply blue Loctite 242 to the eight provided M8x30mm bolts.** Install 1 bolt through the VMV bracket in rear as shown highlighted in green. **Do not** use the dished head bolts shown below for this.



201. Hand tighten all eight M8 bolts.



202. **Torque the M8 bolts to 18 ft-lbs** in the sequence shown. Slowly approach the final torque specifications as you go through the pattern three times. There is a larger version of this diagram at the back of this manual.

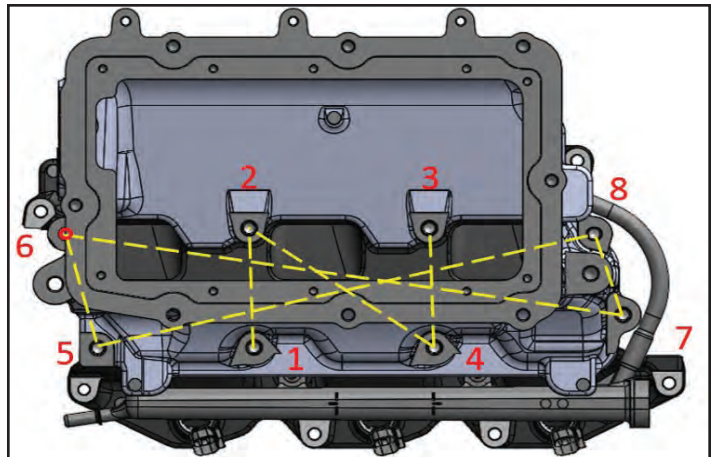

203. Install the VMV onto the bracket on the rear of the Intake flange. Retain the valve to the bracket by putting a zip tie through the hole as shown at the arrow location.

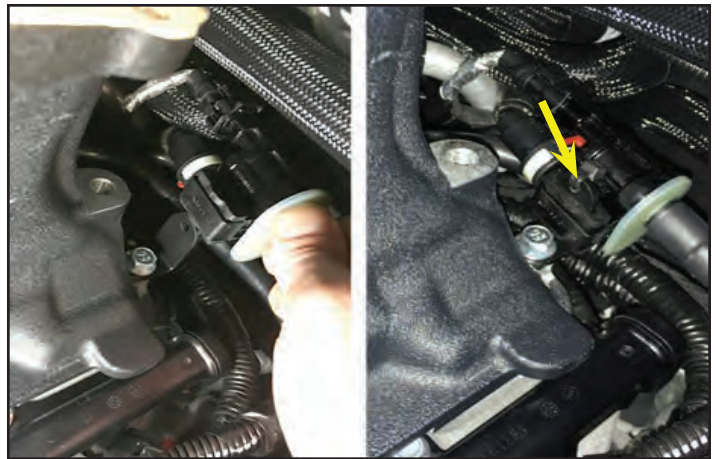

204. Temporarily route the VMV hose as shown in the green highlighted area. Make sure it doesn't get stuck underneath the Supercharger as it is installed over the next few steps.



205. Connect the MAP sensor extension at the red arrow location. Connect the IAT sensor electrical wire at the yellow arrow location.
Note: Make sure to route the wires and retain where needed with cable ties. Wires need to be retained so they do not get in the way of the supercharger as it is loaded in position.

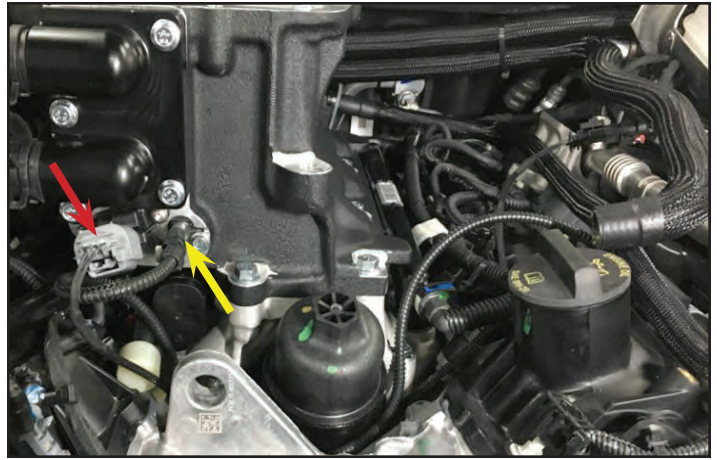

206. Have a friend help you lift the supercharger onto 2 tabs on upper intake manifold. The front tab is shown at the arrow. The other tab is in the back and is shown in the next step. **Apply blue Loctite 242 to the M10 x 40mm bolts and loosely install the front mounting bolt.**



207. Here is the rear location of the tab for mounting the supercharger. Install the rear M10 Supercharger mounting bolt. If you have trouble aligning the rear bolt, lightly tighten the front bolt which should align the rear bolt and allow for easy install. Once both bolts are installed, **torque both to 33 ft-lbs.**

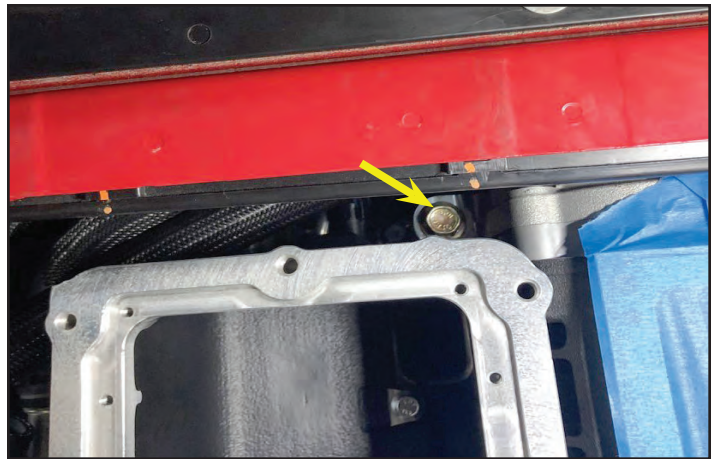

208. Install rear support L-shaped bracket using four M8 x 20mm bolts and **torque to 18 ft-lbs.**



209. Connect the wiring harness bundle to the bracket at the arrow location using 1 push pin (re-use stock brown colored).

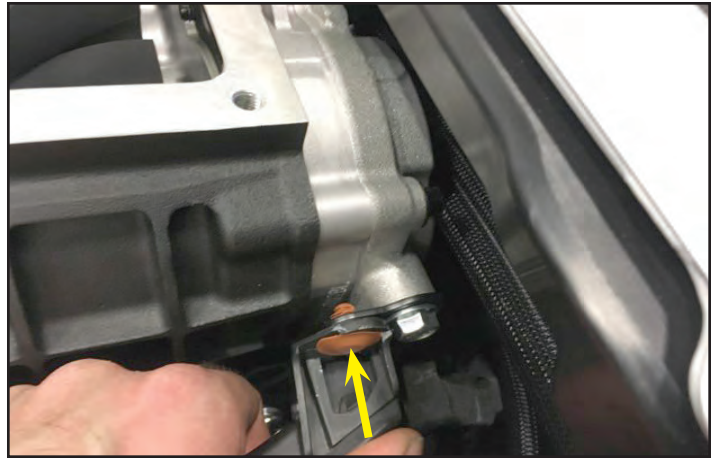

210. Re-connect EGR tube sensor.

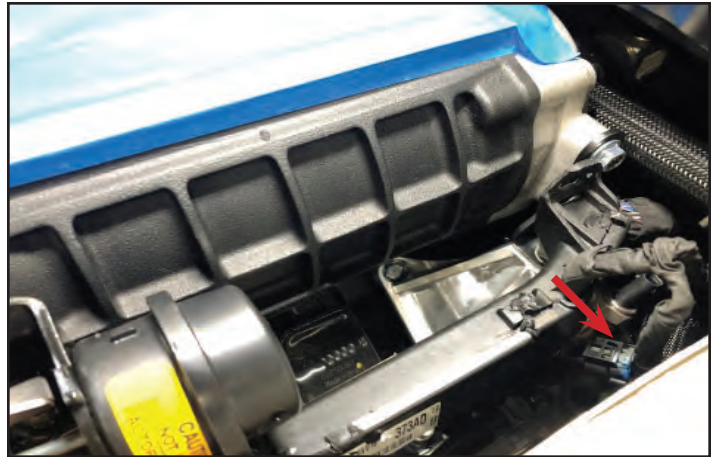

211. Connect VMV hose to the lower air tube on the Supercharger inlet.

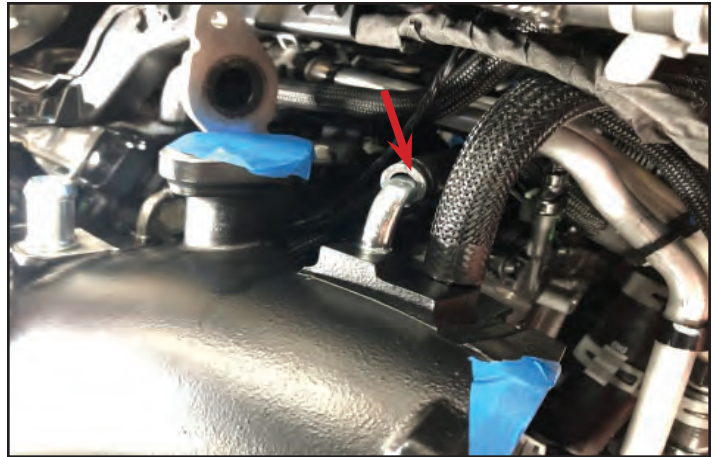

212. Connect brake booster to the Supercharger inlet.



213. Remove the Supercharger pulley to allow access for FEAD bracket mounting. Remove four M6 bolts and pull pulley straight out to disengage the hub.



214. Collect FEAD bracket components.

- 1-FEAD Idler Bracket
- 2-Idler Pulleys
- 2-M10 x 20mm (Idler Pulleys to Bracket)
- 2-M8 x 40mm (Idler Bracket to S/C drive cover)
- 1-M8 x 50mm (Idler bracket thru Engine Front cover)
- 1-Idler bracket mount
- 1-M6 set screw



215. **Apply blue Loctite 242 to M10 bolts** and attach idlers to bracket, **torque to 18 ft-lbs.**

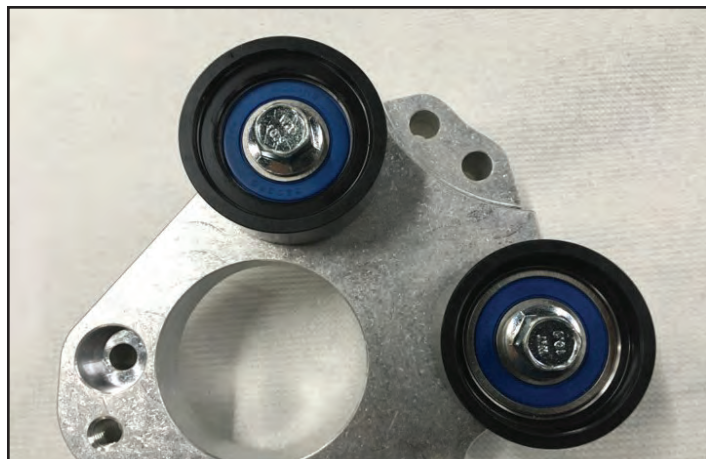

216. **Apply blue Loctite 242 to the two M8 x 40mm bolts** and install the FEAD bracket onto engine with them at the red arrow locations into Supercharger Inlet.

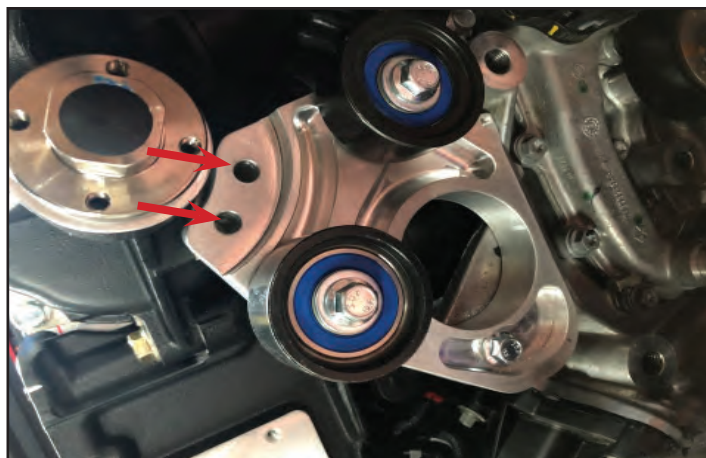

217. **Apply blue Loctite 242 to the one provided M8 x 50mm bolt** along with the FEAD mounting post shown below and install at the arrow location in the photo to the right.



218. Place the FEAD Mounting Post on the backside of the front cover and thread the M8 x 50mm bolt through the bracket hole shown with the yellow arrow into the mounting post. Use a 16mm open end wrench to hold the post. **Torque the 3-M8 bolts to 18 ft-lbs.**



219. **Apply blue Loctite 242 to the supplied set screw.** Install and tighten the set screw at the arrow location. **Torque the set screw to 44 in-lbs.**



220. Install Charge Air Cooler (CAC). **Use blue Loctite 242. Install bolts and torque to 53 in-lbs.**



221. Install Turret O-ring into groove as shown.



222. Lubricate 4 O-rings on floating tubes.

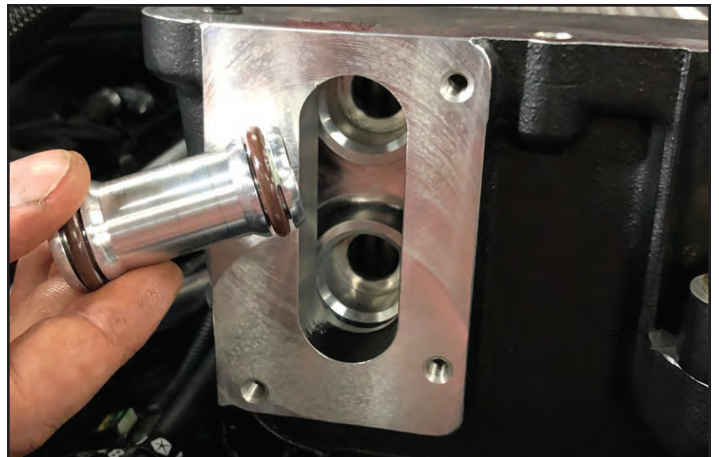

223. Once O-rings are lubricated on tubes press them into CAC.

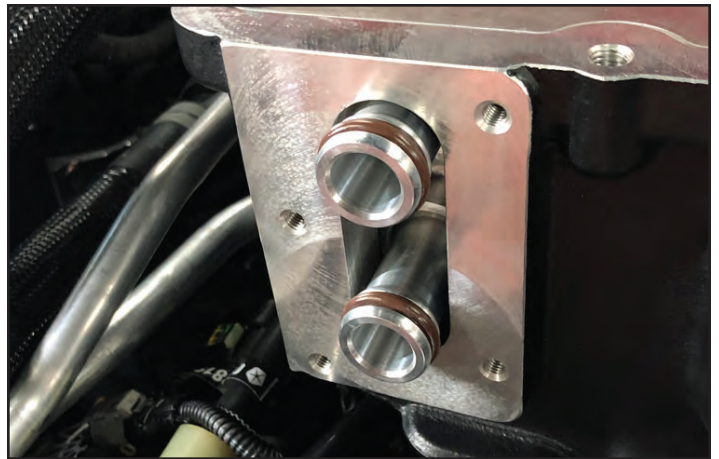

224. Install turret onto floating tubes. Secure to upper intake using four M6 bolts. **Torque to 89 in-lbs.**

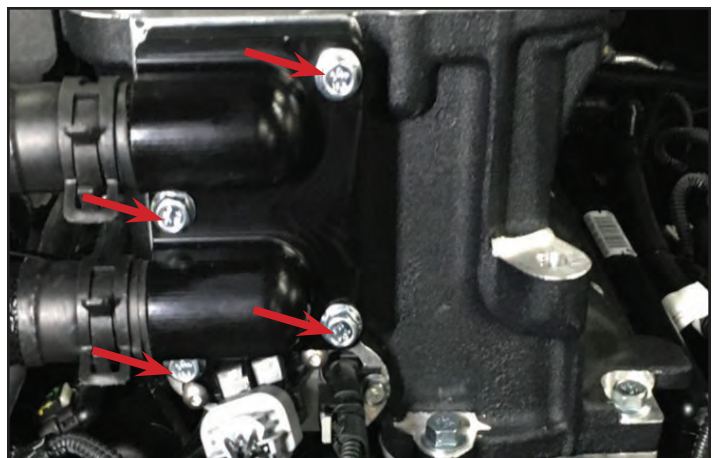

225. Remove tape from the supercharger. Clean the sealing surface of the supercharger and upper intake manifold with lacquer thinner. Ensure that there are no imperfections in the sealing surface.



226. Remove the lid from the bag and check the gaskets for any imperfections.



227. Lid fastener layout:

- Three M8 X 16mm (FAUX-IN **YELLOW**)
- Ten M8 x 30mm (PERIMETER-IN **RED**)
- Two M8 x 45mm (FRONT CENTER-IN **GREEN**)
- Two M8 X 65mm (REAR CENTER-IN **BLUE**)

There is a larger version of this at the back of this manual. **All the lid bolts will have the dished heads shown below.**

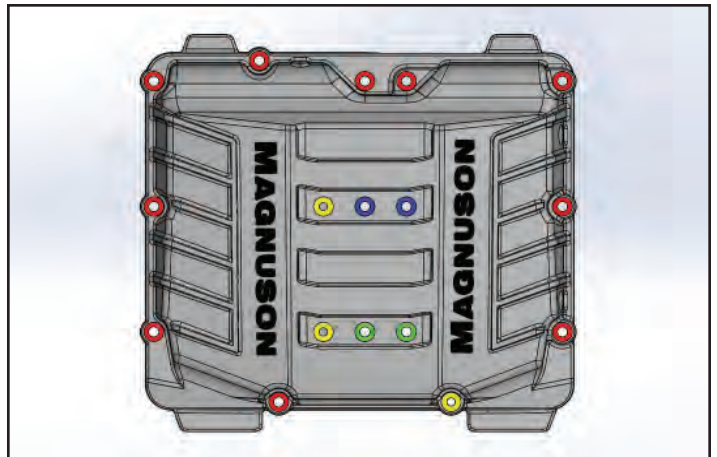

228. Apply blue Loctite 242 to all fasteners. Install lid fasteners hand tight. Then tighten both numeric (yellow) and alphabetical (red) sequence as shown in two cycles. **Tighten the first cycle, yellow and red to 8 ft-lbs. Then do another final cycle in sequence yellow and red at 18 ft-lbs.** There is a larger version of this in the back of this manual.

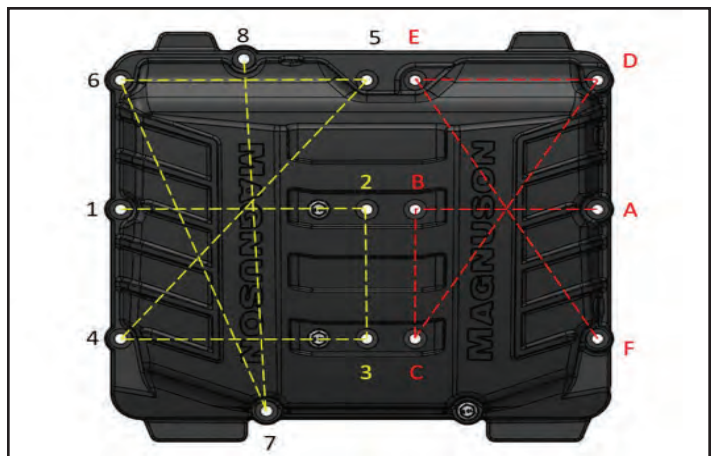

229. Find Intercooler Hose 31-19-36-011B. Using a clamp attach the hose to the rear port on the provided Intercooler coolant reservoir. (shown with red arrow)



230. Install Intercooler reservoir bottle onto the upper Intake bosses. Apply blue Loctite 242 to the three provided M6 x 30mm bolts and install them into the green arrow locations. **Torque these three bolts to 40 in-lbs.**



231. Install clamps onto 31-19-36-011A hose, attach it to the top port on the intake manifold and the front port on the intercooler coolant reservoir (green arrows). Locate intercooler hose 31-19-36-011D which should be laying nearby from an earlier step. Attach a provided clamp to hose and connect the hose to the lower port on the intake manifold as shown. (yellow arrow)

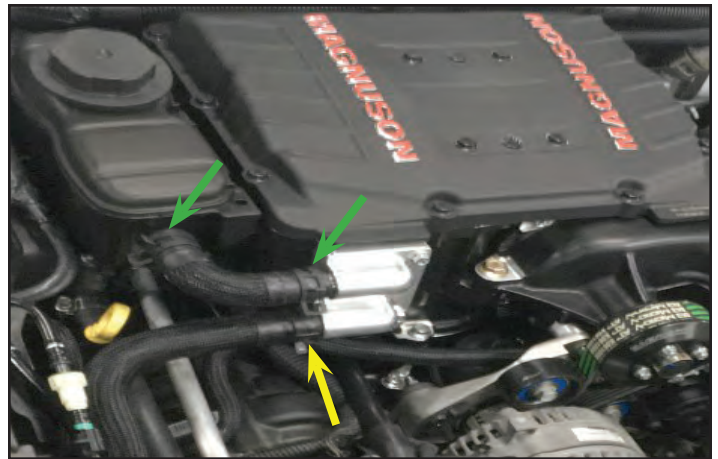

232. Gather the provided front Supercharger inlet support bracket shown along with two M6 x 16mm and two M8 x 20mm bolts.



233. Highlighted in green here is the bracket from the last step located under the throttle body with four supplied bolts. **Torque the M6 x 16mm bolts to 89 in-lbs (yellow arrows), and M8 x 20mm bolts to 15 ft-lbs (red arrows).**

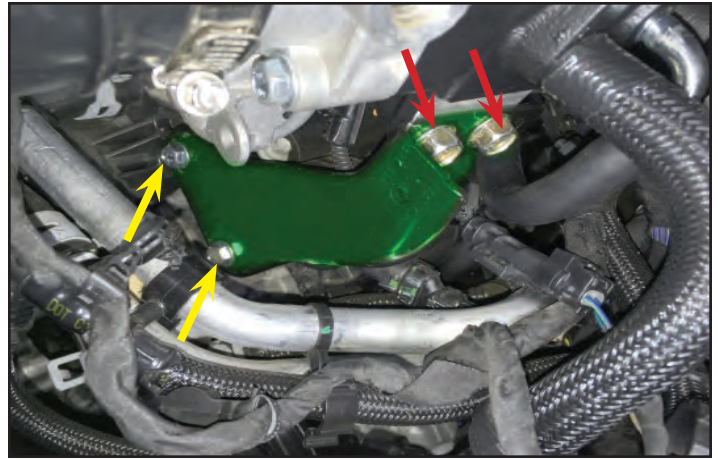

234. Install the OE Throttle Body gasket saved from an earlier step into the groove on the Supercharger Inlet as shown.

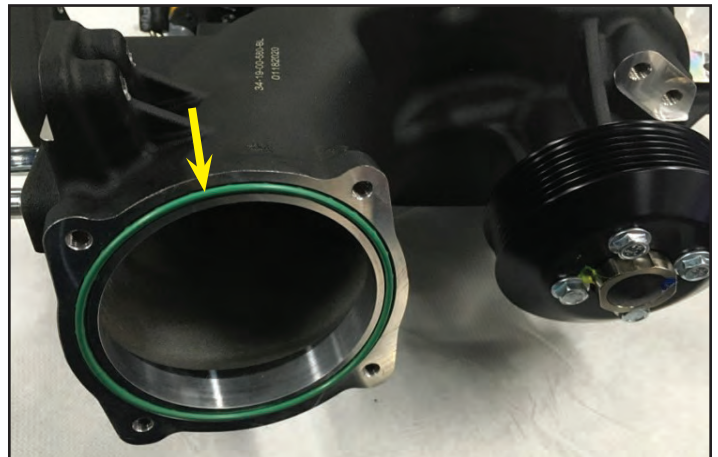

235. Install Throttle Body and **torque to 106in-lbs. NOTE: Make sure the Throttle Body is installed in the proper orientation as shown**

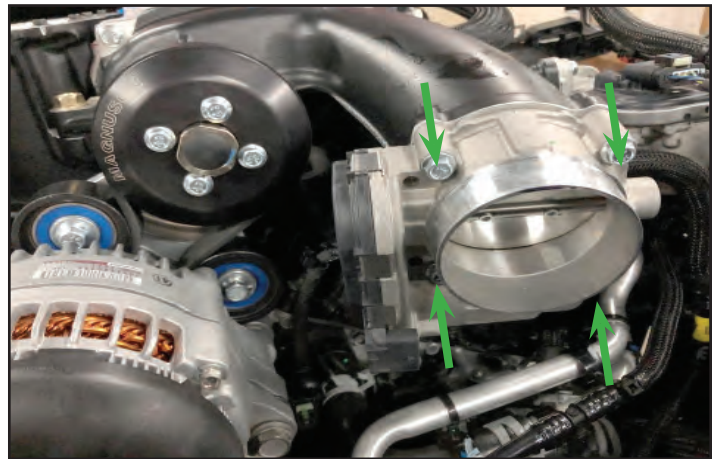

236. Reconnect electrical connector and lock tab at arrow location.



237. Install the supercharger pulley onto the input shaft hub **using blue Loctite 242 on the four M6 bolts** and tighten by hand. Full torque will be applied after the belt has been installed in a later step.



238. Install belt onto the OE and currently installed pulleys as shown. Alternator bracket and the alternator itself will be installed next. Note: Slipping belt off the smooth water pump pulley makes this install possible without having to adjust the tensioner.



239. Here is a belt routing diagram for the supercharger. **A larger version of this diagram is at the back of this manual.** (Supercharger Belt= Gates# K060980)

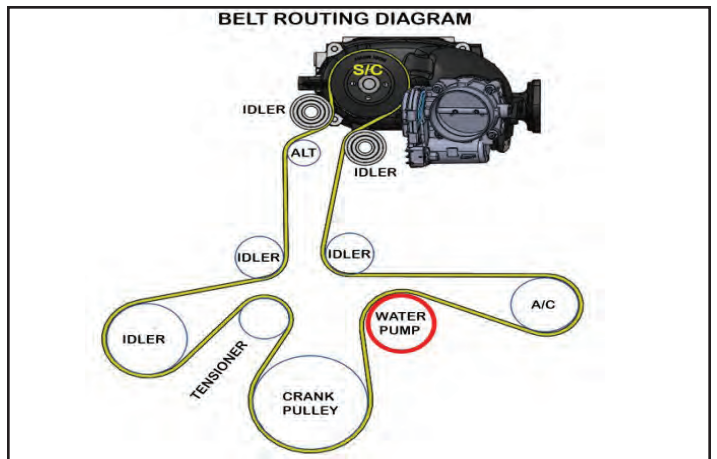

240. Re-install the lower alternator mounting bracket reusing the OE hardware. Make sure to properly route belt over the idler. **Be careful not to route belt around the bracket mounting post.**



241. Install the alternator reusing the OE hardware. Make sure to properly route the belt over the alternator pulley. Then reconnect the electrical connector and power cable with cover.



242. Make sure the belt route is correct on all pulleys except water pump. Torque the tensioner to loosen the belt and carefully slip the belt back over the water pump pulley. Once the system is correctly routed and under tension, **tighten the four supercharger pulley bolts to 106 in-lbs.**

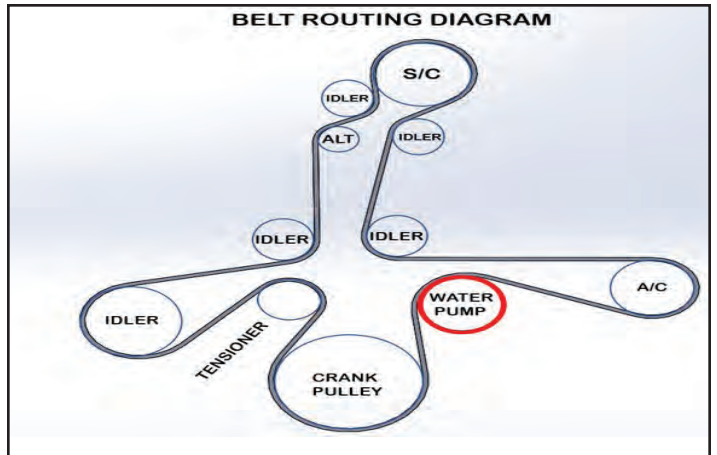

243. Reinstall air pump bracket assembly. Make sure to completely re-connect the vacuum line with red lock and the pump electrical connector.



244. Install O-ring into Supercharger inlet EGR flange.

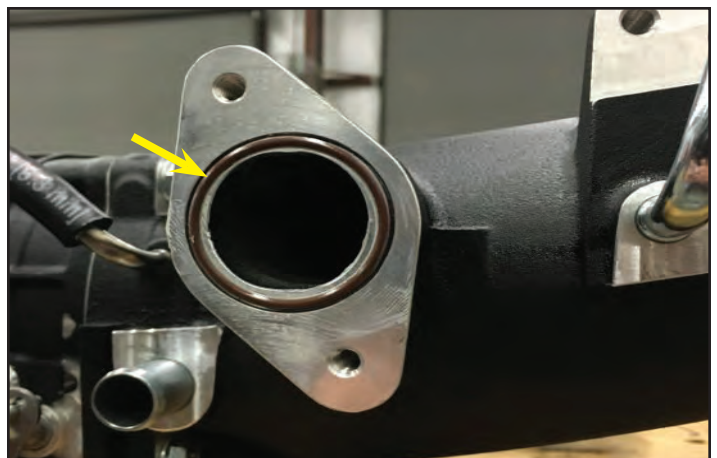

245. Install the EGR Valve bottom M6 x 30mm bolt finger tight into Supercharger inlet at the arrow location.



246. Install the EGR Tube Gasket and attach to valve re-using gasket & M6 bolts – finger tight.



247. The arrow locations indicate the two M6 bolts from the last step that are to be finger tight for now.



248. Install EGR valve top M6x30mm bolt into the S/C inlet at the arrow location.



249. **Tighten all EGR bolts to 106 in-lbs.**



250. Plug in electrical connector and lock tab.



251. Ensure that there is a clean filter in the airbox, and then locate it back in the grommets that were reinstalled just after the airbox was removed.



252. Install 10mm bolt for the airbox.

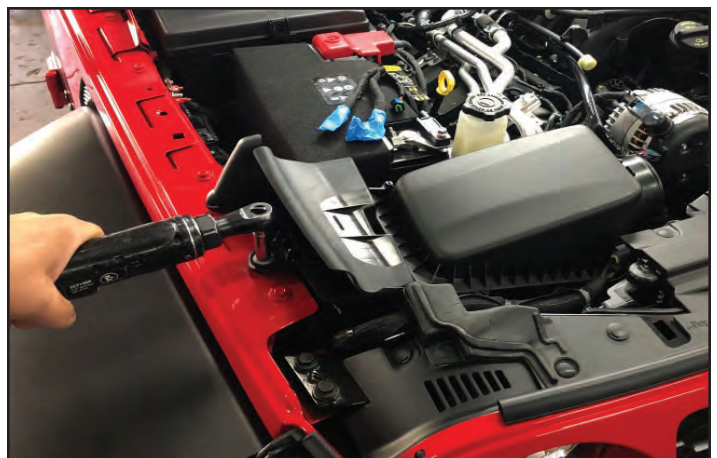

253. Install the supplied Clean Air Tube and tighten clamps.



254. Connect the PCV "fresh" OE hose to the Clean Air Tube fitting.



255. Reinstall front closeout panel with push pins.

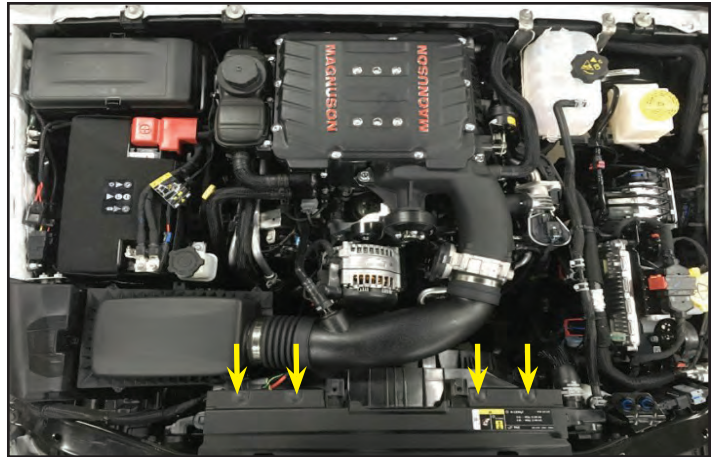

256. Reinstall the front grill assembly with/push pins at the 6 arrow locations.

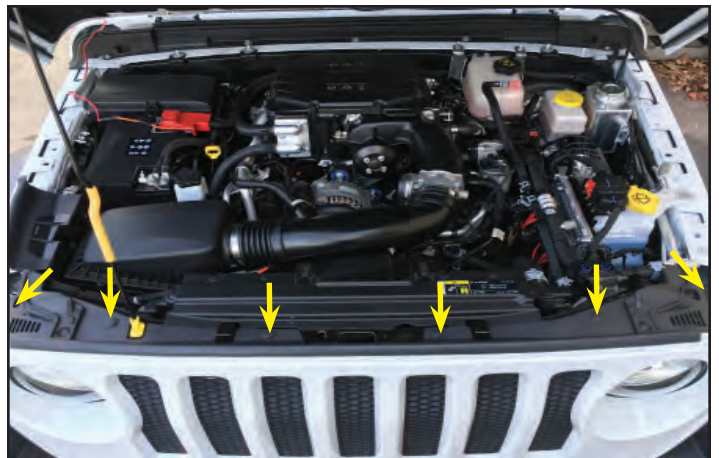

257. Reconnect the wires to your battery terminals. Ensure that all three connections are tight.



Make sure that you have followed the steps at the beginning of this manual and in the addendum manual to load the proper Supercharger calibration to your vehicle's ECM.

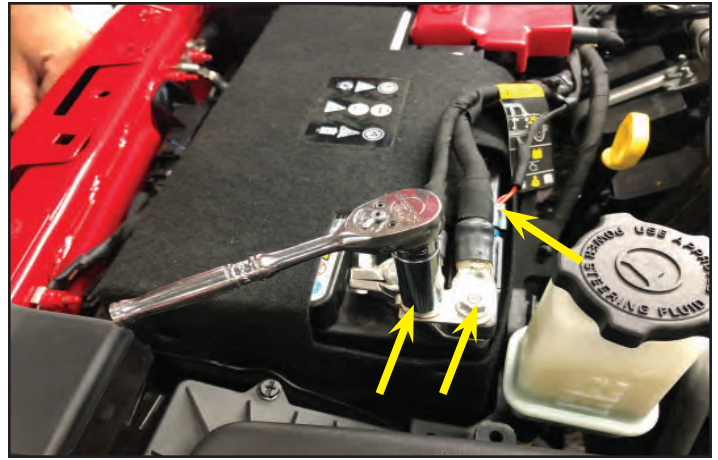

258. Connect ground wire to stud shown with arrow and tighten in place with nut.

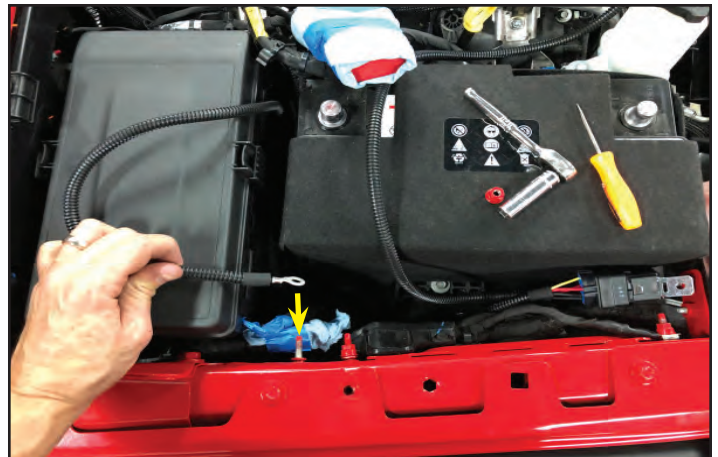

259. Remove the nut at the arrow location and mount the relay to stud on top of the OEM ground wire eyelet connector and reinstall the nut



*****WARNING: You must perform a vacuum leak down test on your intercooler system prior to adding any coolant. This can be accomplished with the same equipment that is used for engine cooling systems.*****

260. **Ensure that the radiator petcock is closed.** Refill coolant system per Jeep Manual. Fill Supercharger Intercooler system with coolant at the reservoir using the same type of coolant that is recommended for your engine coolant system following the steps that begin on the next page.



Section 13: Intercooler System Filling and Air Removal

261. **If air is present in the system, the intercooler pump will automatically shut off leading to excessively high intake air temperatures which can cause engine damage. Therefore we highly recommend using a cooling system vacuum purge and refill kit as shown here to properly fill the system.**

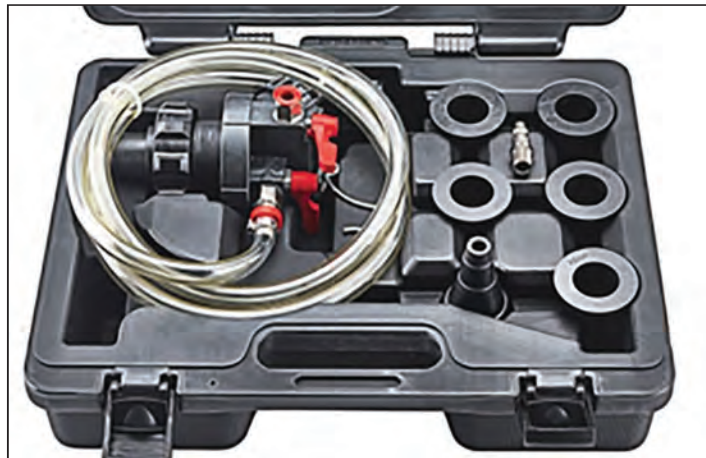

262. Remove the cap from the degas bottle and using the correct adapter, connect the “Evac” tool to the filler neck.



263. Connect the shop air to the tool, and submerge the fill hose into the fill coolant container.



264. Pull a partial vacuum on the system and close the vacuum line.



265. Slowly open the fill valve and purge all the air out of the fill hose to avoid any air being introduced during the fill process, and once the coolant gets to the valve close it.



266. Pull a vacuum until all of the air is out of the system. All of the intercooler system hoses will be fully collapsed and the needle will stop rising. Close the vacuum valve and let the system sit for a few minutes and make sure the vacuum holds. This will help insure that the system has no leaks. **If the gauge loses vacuum, YOU HAVE A LEAK somewhere in the system.** This leak must be found and repaired as it could be a rolled O-Ring on the extension tubes from the coolant manifold to the CAC. (Charge Air Cooler) If an O-Ring is leaking then the coolant from this system can leak into the engine and cause damage.



267. Once all the vacuum is gone, remove the tool from the tank, but do not install the cap yet. At this point start the engine and make sure the coolant is flowing vigorously through the bottle. (The pump takes a few seconds to ramp up so be patient). Once the coolant is flowing, shut the engine off and let the coolant settle. Once the coolant has settled, fill the bottle so that the level is just above the inlet to the tank.



268. If you are unable to use a vacuum purge and refill kit you can follow the directions in the next step to fill your system manually.

269. Option #2: Manual filling.

- a. Using a coolant funnel attach the correct adaptor to the intercooler reservoir.
- b. Connect the funnel to the adaptor.
- c. Fill the funnel to the $\frac{1}{2}$ way mark with a 50/50 mixture of the same coolant approved by the OEM. If you don't have the funnel shown make sure the reservoir tank is full.
- d. Remove the trigger wire from the fuse in the fuse box and touch it directly to a 12 volt source. While the pump runs you need to massage the 31-19-36-011C hose to try and force the air up out of the system. Repeat touching the trigger wire to the 12v source for the duration of the pump running.
- e. As the level drops in the tank, make sure that you pause and refill the tank to prevent any air from getting back into the system.
- f. Once coolant starts flowing keep the trigger wire to the 12V supply, add coolant as needed until the coolant flows consistently.
- g. Remove the trigger wire from the 12v source. Fill the tank back up to above the inlet port to the tank, put the cap on, and re-connect the trigger wire to the fuse in the fuse box.
- h. Start the vehicle and verify the intercooler system is running.



270. Start the vehicle for 5 seconds and shut it off. Check for fuel leaks and supercharger belt alignment. Check the intercooler reservoir level. Now start your engine and let it run for a few minutes to let it get to operating conditions. Let the engine cool down, and check all your levels again.



271. Test drive vehicle for the first few miles under normal driving conditions. **Do not perform any wide open throttle runs.** Listen for any noises, vibrations, engine misfire or anything that does not seem normal. The supercharger does have a slight whining noise under boost conditions, which is normal. Check and top off the intercooler reservoir as needed.

**TURN OFF Traction Control
For Off Road/Racing use.**



272. After the initial test drive gradually work the vehicle to wide open throttle runs, listen for any engine detonation (pinging). If engine detonation is present let up on the throttle immediately. Most detonation causes are low octane gasoline still in the tank.

If you have questions about your vehicles performance, please check with your installation facility.

After you finish your installation and road test your vehicle, please fill out the warranty registration. This can be found on our website.



273. Clean the surface at the arrow location and apply the provided CARB EO label as shown.

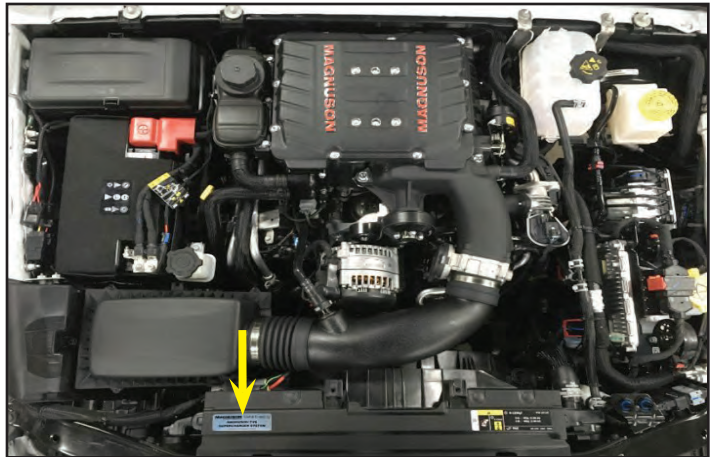

274. Clean the surface at the arrow location and apply the provided "Use Premium Fuel Only" label as shown.

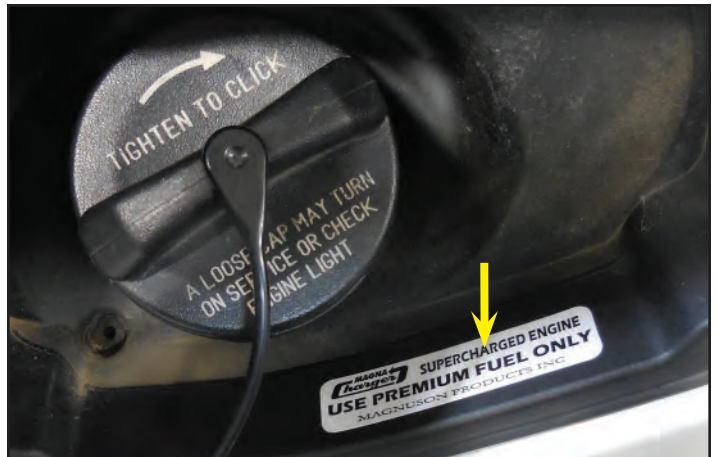

Section 14: Oil Filter and Fill Cap Removal Information

275. The next few steps show the process for accessing and removing the Oil Cap and Oil Filter Cap, as the supercharger kit reduces clearance in these areas. The remainder of the oil changing process is unaffected and will remain the same as OEM process. Parts and tools needed to replace Oil Filter are shown here.

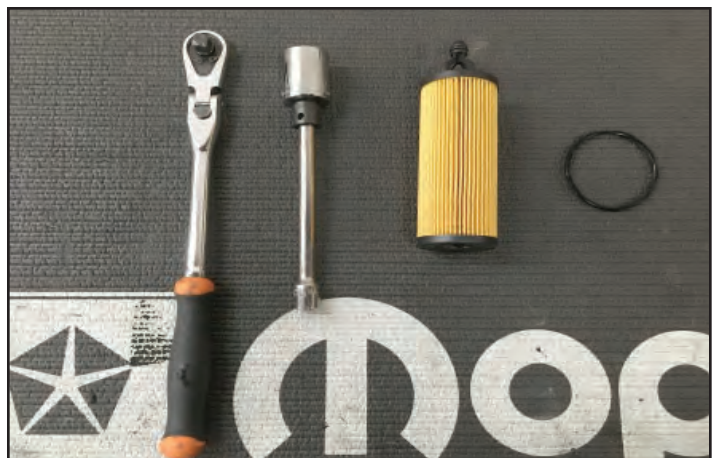

276. To remove the cap and access the Oil Filter you will need a 24mm socket and extension as shown.

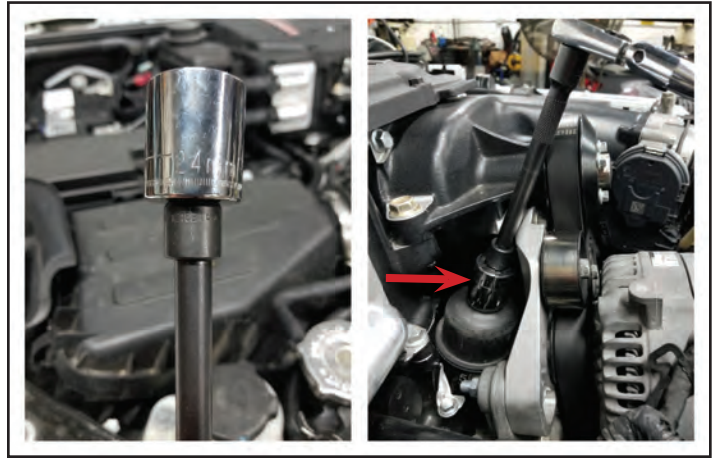

277. Once the cap is loose pull up to remove, it is normal for the cap to disconnect from the filter during this process.

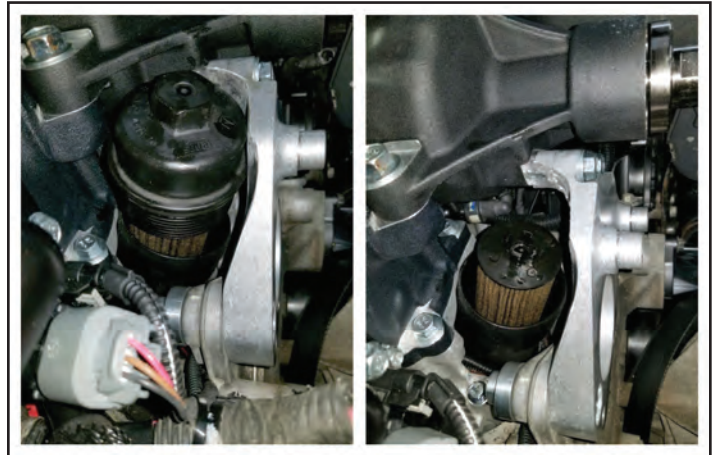

278. Carefully remove and discard used oil filter.

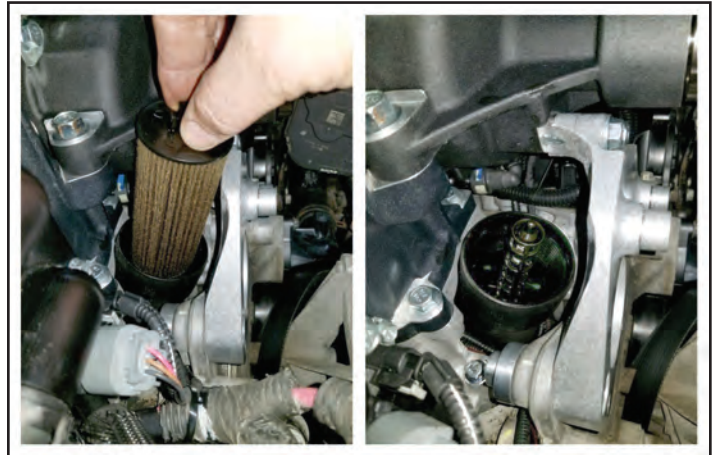

279. Assemble the new filter and O-ring (arrow location) to the OEM Oil Filter Cap and re-install as shown.



280. Use a torque wrench to tighten to 18 ft-lbs.



281. The Oil Fill Cap is located between the supercharger inlet and drive pulley. To remove we recommend using needle nose pliers to grab the handle of the cap and rotate to release. Once the cap is loose, use the same pliers to completely remove the oil cap. Re-installation of the cap after filling with oil will be the same process reversed. (Always make sure the cap has been re-installed properly)

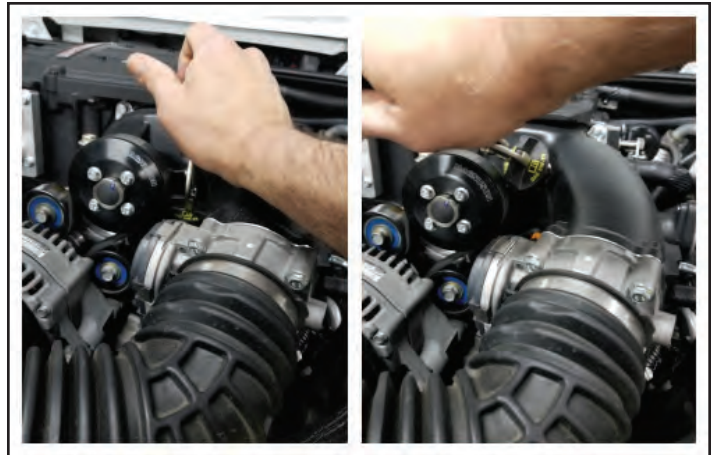

282. We recommend using a large funnel during the fill process to prevent spillage.



VACUUM ROUTING DIAGRAM

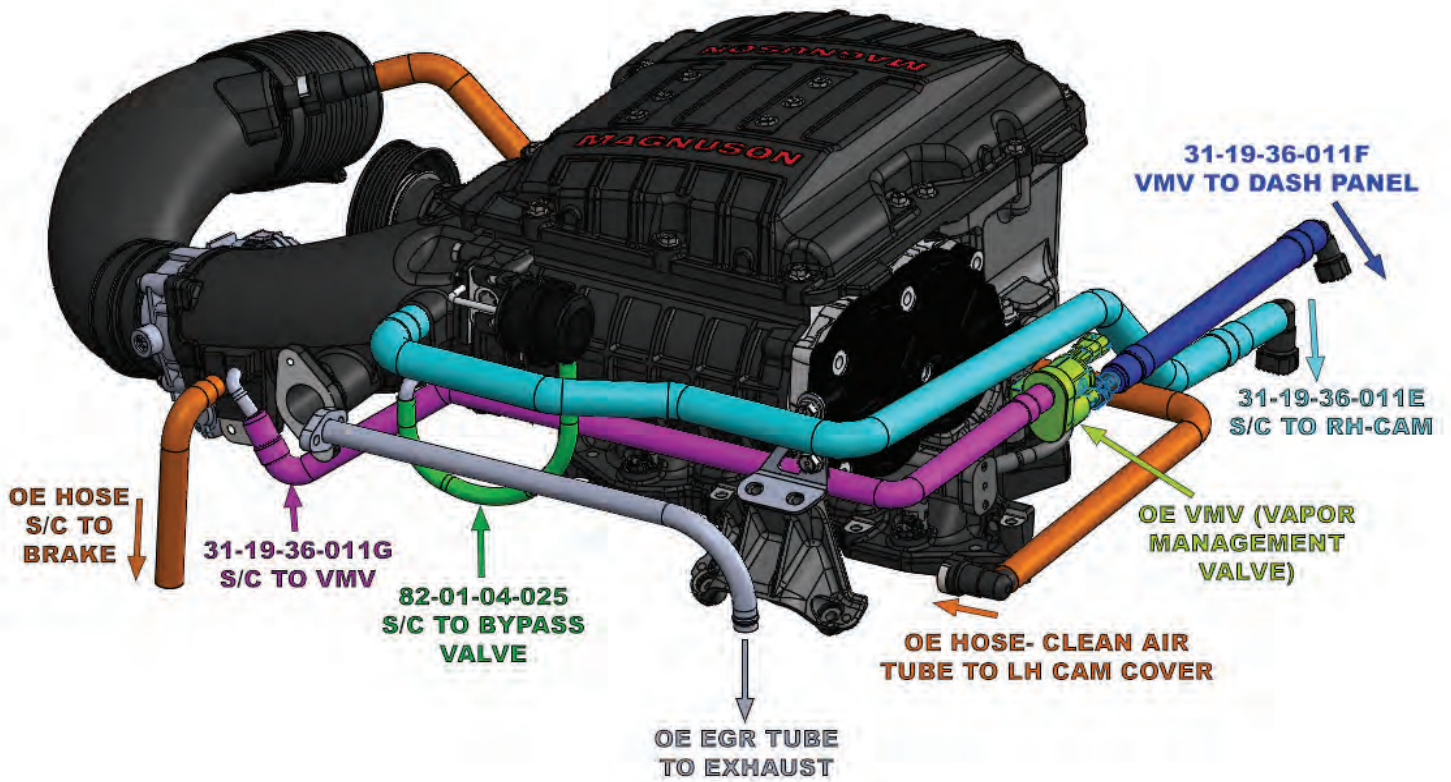

Appendix

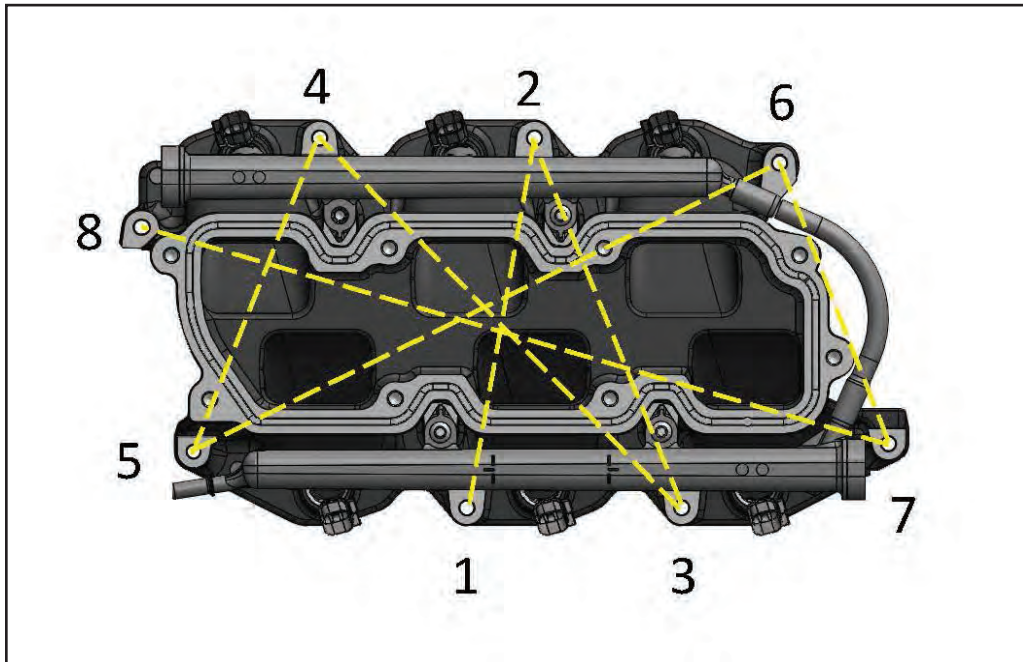

Torque Sequence for Lower Intake Manifold (106 in-lbs)

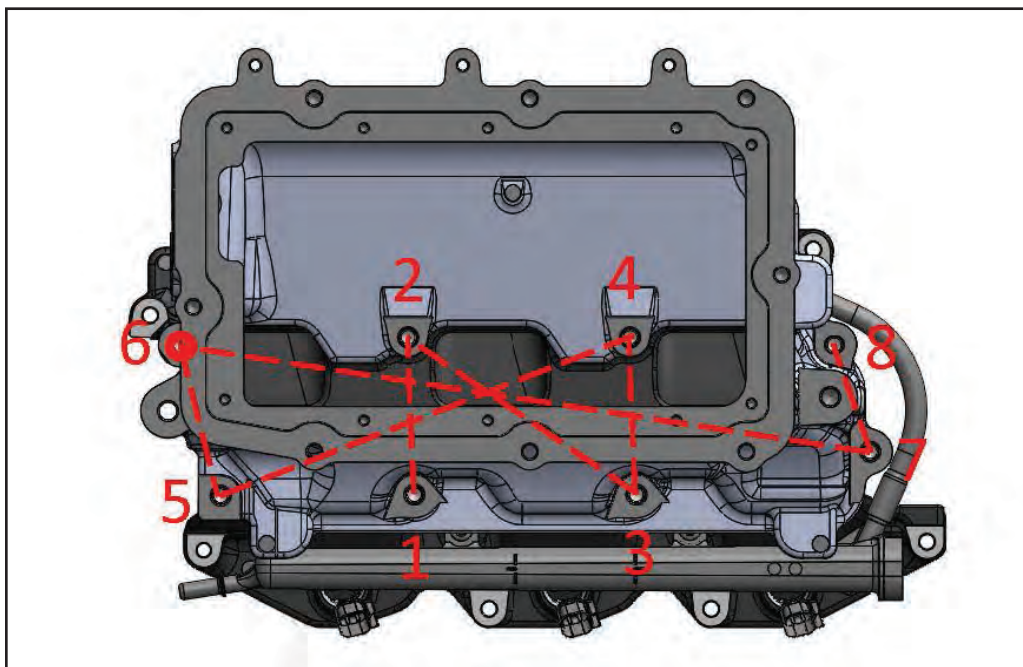

Torque Sequence for Upper Intake Manifold (18 ft-lbs)

Appendix

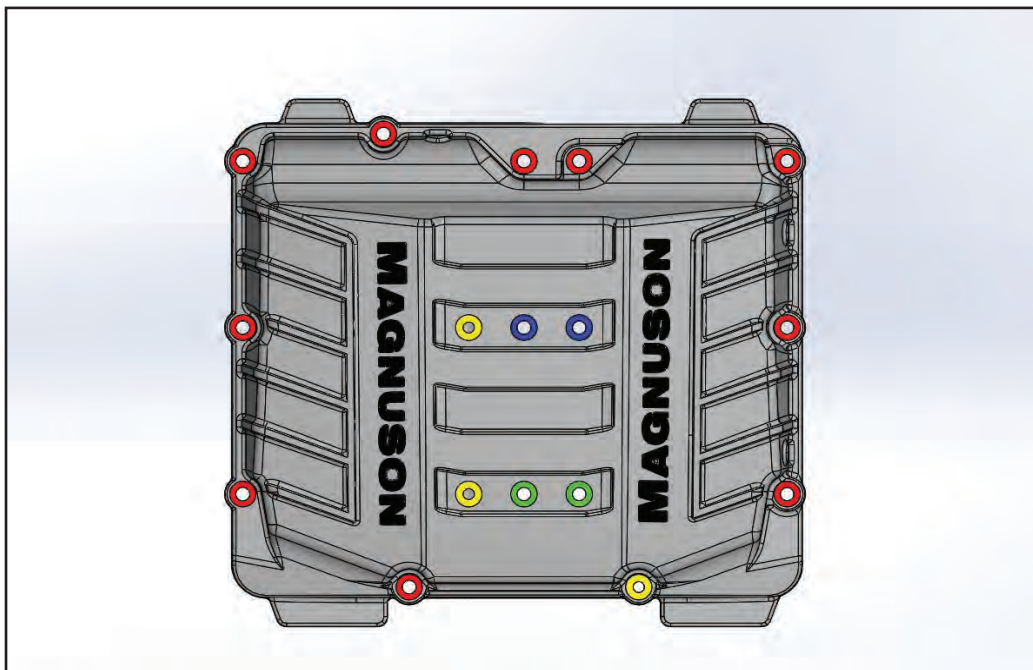

Lid fastener layout:

Three M8 X 16mm (FAUX-IN **YELLOW**)

Ten M8 x 30mm (PERIMETER-IN **RED**)

Two M8 x 45mm (FRONT CENTER-IN **GREEN**)

Two M8 X 65mm (REAR CENTER-IN **BLUE**)

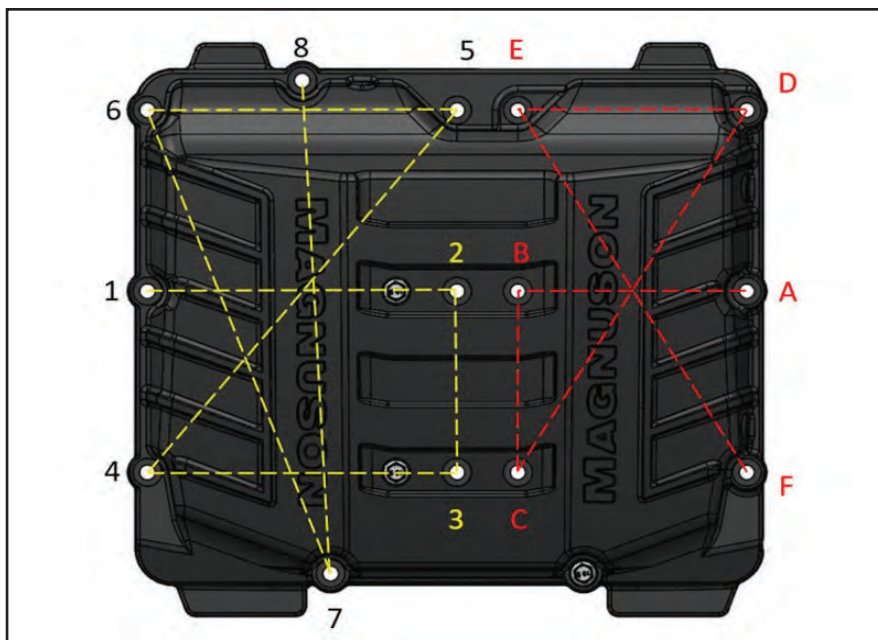

Torque Sequence for Lid (18 ft-lbs)

Appendix

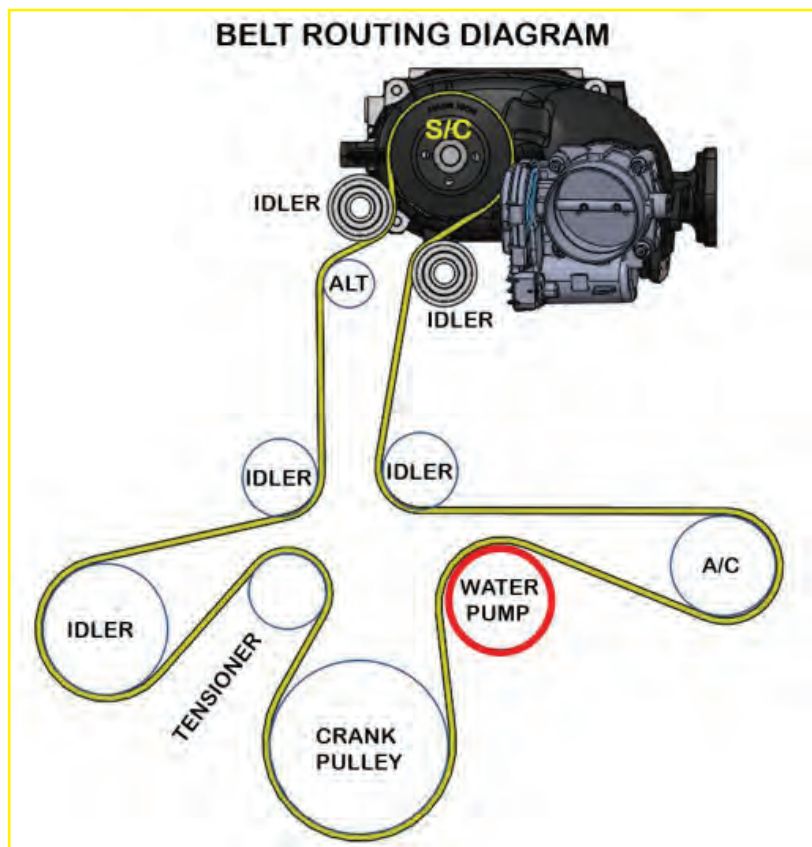
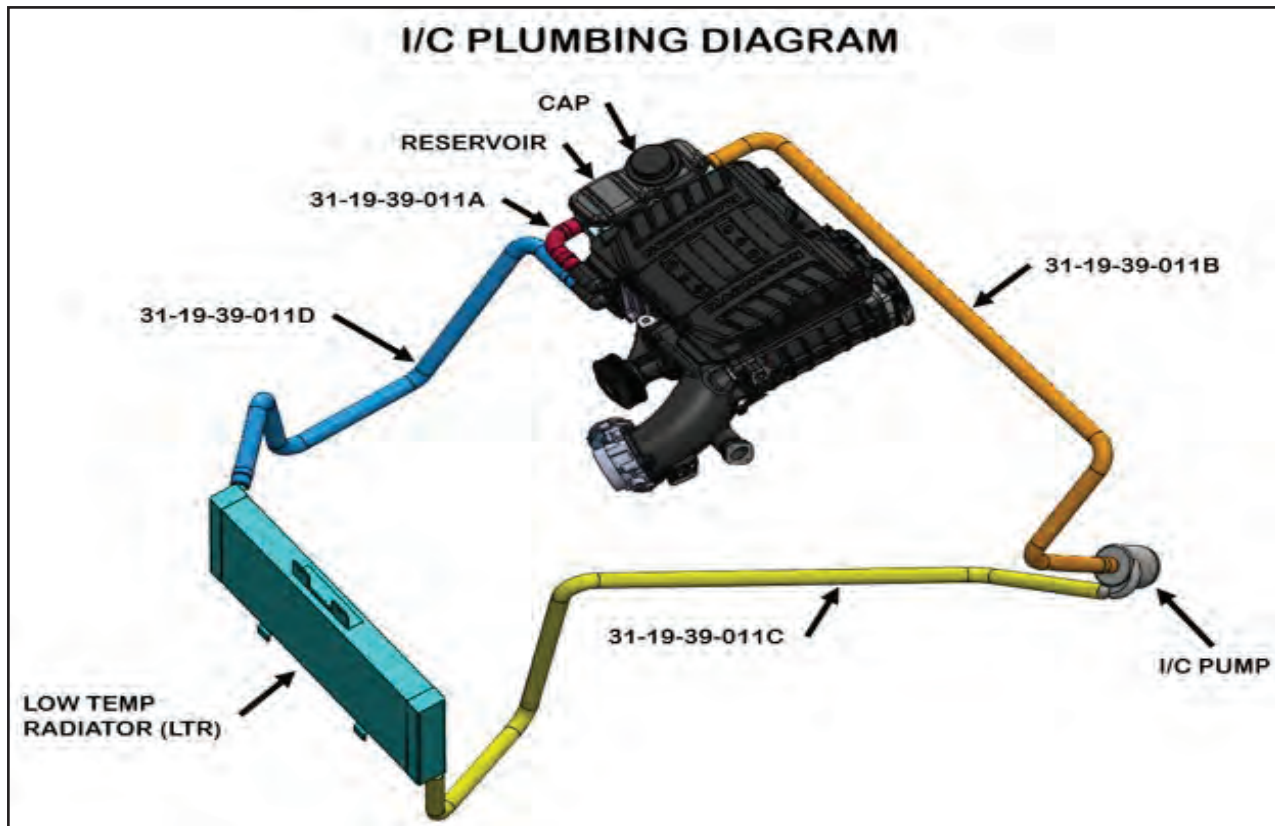

Supercharger Belt = Gates# K060980



Please enjoy your "Magnuson SuperCharged" performance responsibly.

*** PREMIUM 91 OCTANE GASOLINE FUEL REQUIRED ***

***TURN OFF Traction Control
For Off Road/Racing use.***

MAGNUSON
SUPERCHARGERS