

EVO

MANUFACTURING

2007-2018 JEEP WRANGLER JK / JKU
2018-2019 JEEP WRANGLER JL / JLU
2020 JEEP GLADIATOR JT



2019



EVO Manufacturing was founded in 2008 by Mel Wade, an avid 4 wheeler/master mechanic and Andrew Perle, raised in desert racing and a mechanical engineer. The 2 saw a need for well engineered, properly tuned suspension systems and accessories in the Jeep Wrangler market. They paired to do just that. Through their experience, EVO Manufacturing (EVO MFG) solidifies performance and quality. Driven by industry leaders, engineered and tested like no other, EVO MFG's focus on innovation is unmatched. Our efforts are guided by bringing the highest quality and performance minded products to you. Engineered and manufactured in the USA, proven worldwide. EVO MFG is unsurpassed!

The logo for EVO Manufacturing features the letters 'EVO' in a large, stylized, black font. The 'E' is composed of three horizontal bars. The 'V' is a simple, bold shape. The 'O' is a circle with a crosshair inside. Below the letters, the word 'MANUFACTURING' is written in a smaller, black, sans-serif font.

EVO
MANUFACTURING



TABLE OF CONTENTS

**2018-2019 JEEP WRANGLER JL/JLU
SUSPENSION SYSTEMS 4-9**

**2018-2019 JEEP WRANGLER JL/JLU
SUSPENSION COMPONENTS & UPGRADES 10-12**

**2020 JEEP GLADIATOR JT
SUSPENSION SYSTEMS 13-16**

**2020 JEEP GLADIATOR JT
COMPONENTS & UPGRADES 17-18**

**2007-2018 JEEP WRANGLER JK/JKU
SUSPENSION SYSTEMS 19-25**

**2007-2018 JEEP JK/JKU
COMPONENTS & UPGRADES 26-27**

**2018-2019 JEEP WRANGLER JL/JLU
2020 JEEP GLADIATOR JT BUMPERS,
TIRE CARRIERS & ARMOR 28-32**

**2007-2018 JEEP WRANGLER JK/JKU
BUMPERS AND TIRE CARRIERS 33**

**2007-2018 JEEP WRANGLER JK/JKU
ARMOR 35**

**2007-2018 JEEP WRANGLER JK/JKU
PROTEK ARMOR AND SKIDS 36-37**

**2007-2018 JEEP WRANGLER JK / JKU
ACCESSORIES 38**

SUSPENSION SYSTEMS

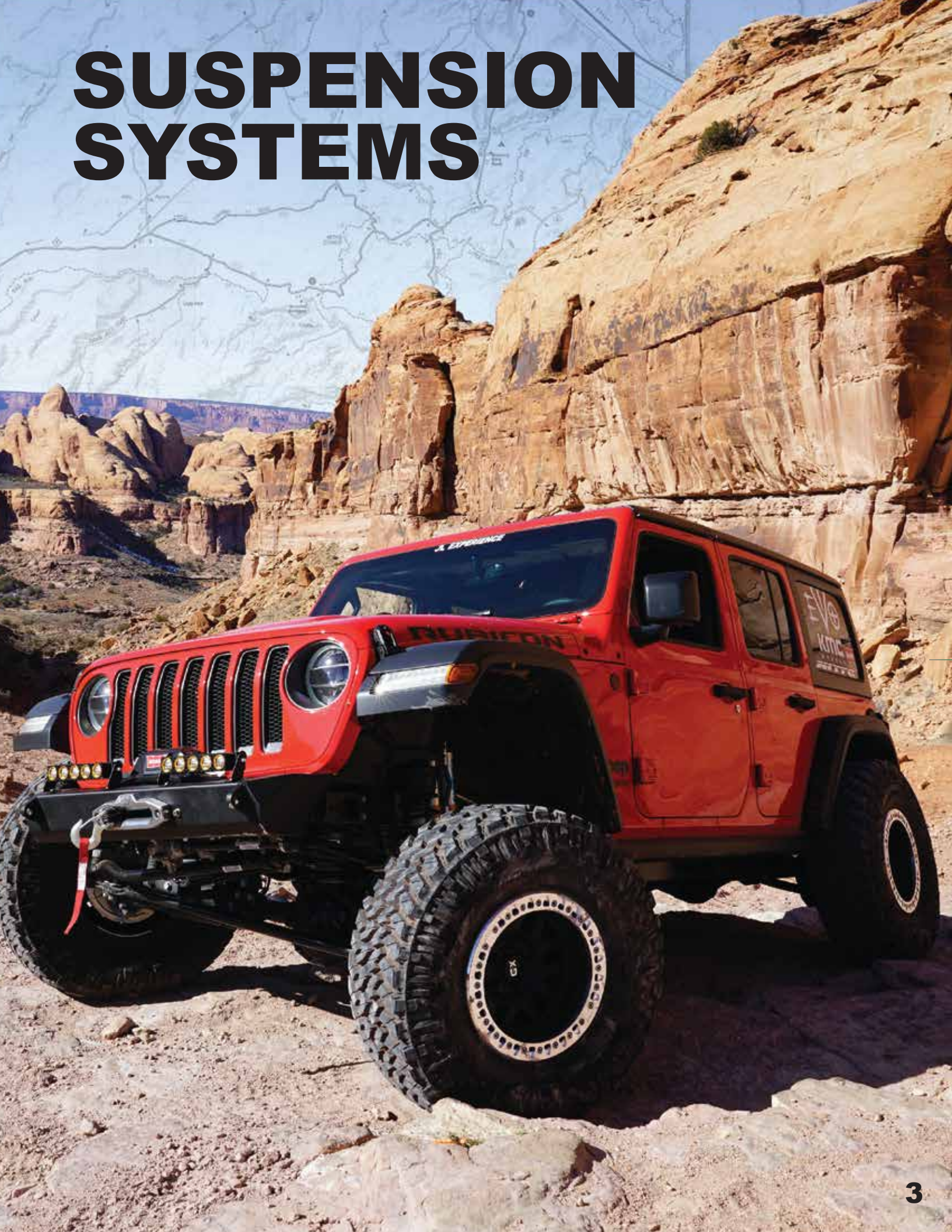

2018-2019 JEEP WRANGLER JL/JLU SUSPENSION SYSTEMS

JL/JLU SUSPENSION SYSTEM STAGE INFORMATION

STAGE 1:	Includes the basic components to lift your JL/JLU
STAGE 2:	Includes all components of stage 1 with the addition of adjustable front Lower enforcer control arms. This allows for front caster adjustments.
STAGE 3:	Includes all components of stage 2 with the addition of adjustable rear upper Enforcer control arms. This allows for rear axle pinion angle adjustments
STAGE 4:	Includes all component of stage 1 with the addition of "all 8" (Front and rear upper and lower) adjustable enforcer control arms.

Plus ("P") kits include the addition of front and rear adjustable track bars
"K" kits include a full set, front and rear king 2.5" dia remote reservoir shocks.
PRO kits are front and rear coilover suspension systems



2018-2019 JEEP WRANGLER JL/JLU SUSPENSION SYSTEMS

HIGH CLEARANCE PRO COILOVER LONG ARM

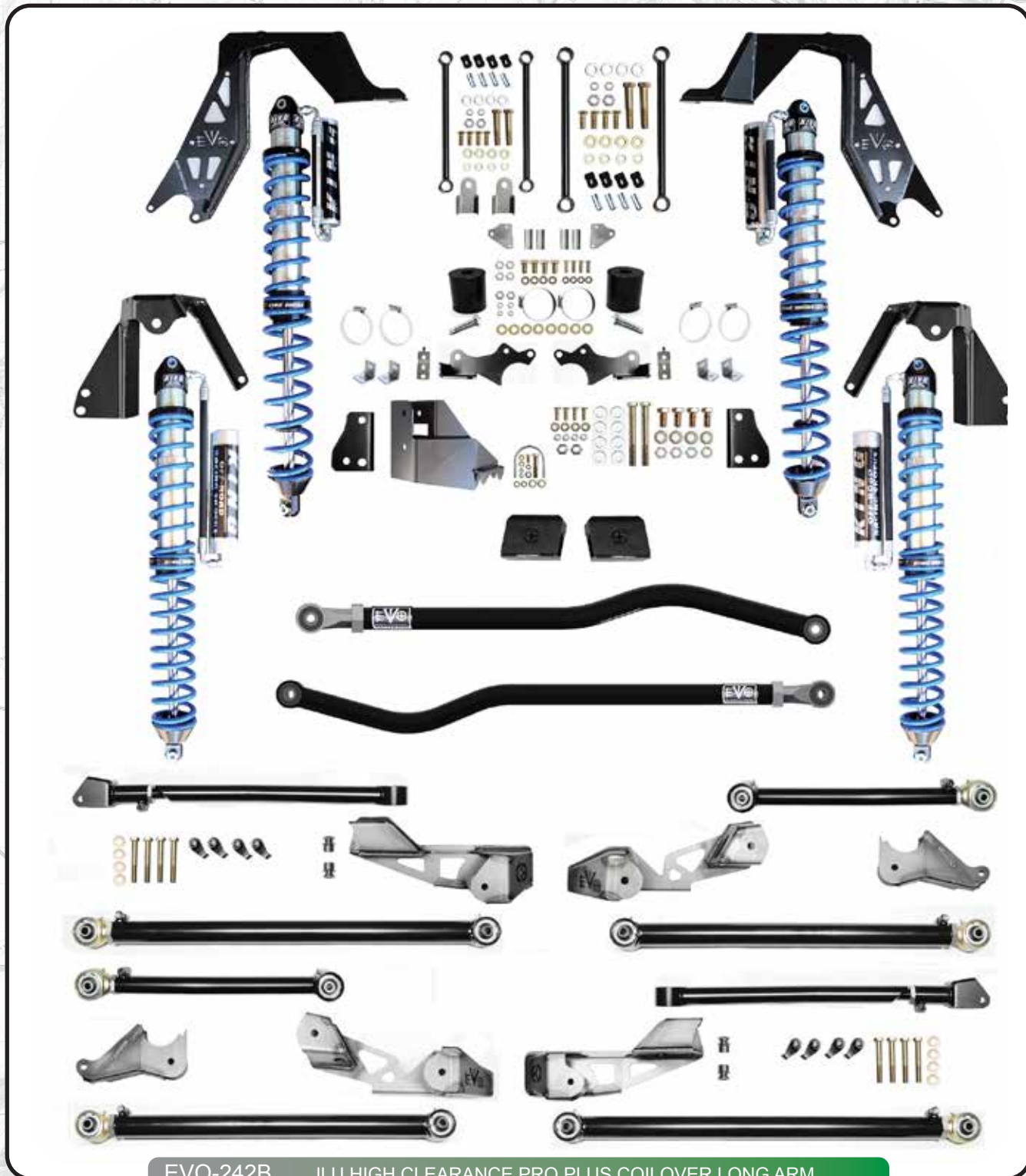

EVO-242B JLU HIGH CLEARANCE PRO PLUS COILOVER LONG ARM
EVO-242BP JLU HIGH CLEARANCE PRO PLUS COILOVER LONG ARM PLUS

Compression adjust coilovers available - special order/leadtime

2018-2019 JEEP WRANGLER JL/JLU SUSPENSION SYSTEMS

ENFORCER PRO COILOVER



JL / JLU ENFORCER PRO

STAGE 1	EVO-241B-1 EVO-241B-1P	ENFORCER PRO STAGE 1 ENFORCER PRO STAGE 1 PLUS
STAGE 2	EVO-241B-2 EVO-241B-2P	ENFORCER PRO STAGE 2 ENFORCER PRO STAGE 2 PLUS
STAGE 3	EVO-241B-3 EVO-241B-3P	ENFORCER PRO STAGE 3 ENFORCER PRO STAGE 3 PLUS
STAGE 4	EVO-241B-4 EVO-241B-4P	ENFORCER PRO STAGE 4 ENFORCER PRO STAGE 4 PLUS

Compression adjust coilovers available- special order/leadtime

2018-2019 JEEP WRANGLER JL/JLU SUSPENSION SYSTEMS

HIGH CLEARANCE LONG ARM 2.5" 3.5" OR 4.5" LIFT HEIGHTS

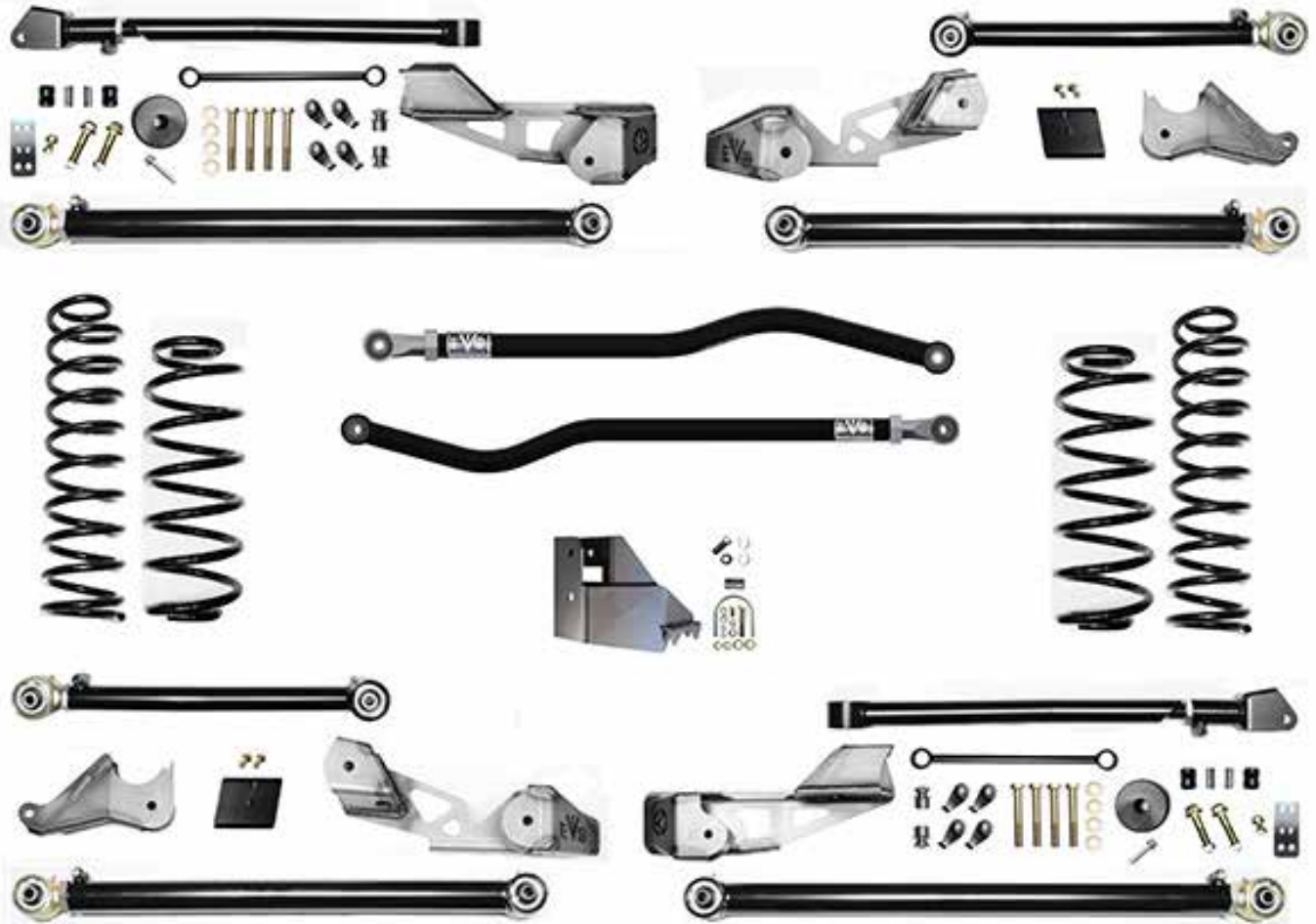

JL / JLU HIGH CLEARANCE LONG ARM

2.5"	EVO-3015	2.5" HIGH CLEARANCE LONG ARM
	EVO-3015P	2.5" HIGH CLEARANCE LONG ARM PLUS
	EVO-3015K	2.5" HIGH CLEARANCE LONG ARM, W/ 2.5" DIA KING RESERVOIR SHOCKS
	EVO-3015PK	2.5" HIGH CLEARANCE LONG ARM PLUS, W/ 2.5" DIA KING RESERVOIR SHOCKS
3.5"	EVO-3016	3.5" HIGH CLEARANCE LONG ARM
	EVO-3016P	3.5" HIGH CLEARANCE LONG ARM PLUS
	EVO-3016K	3.5" HIGH CLEARANCE LONG ARM, W/ 2.5" DIA KING RESERVOIR SHOCKS
	EVO-3016PK	3.5" HIGH CLEARANCE LONG ARM PLUS, W/ 2.5" DIA KING RESERVOIR SHOCKS
4.5"	EVO-3056	4.5" HIGH CLEARANCE LONG ARM
	EVO-3056P	4.5" HIGH CLEARANCE LONG ARM PLUS
	EVO-3056K	4.5" HIGH CLEARANCE LONG ARM, W/ 2.5" DIA KING RESERVOIR SHOCKS
	EVO-3056PK	4.5" HIGH CLEARANCE LONG ARM PLUS, W/ 2.5" DIA KING RESERVOIR SHOCKS

Compression adjust shocks available- special order/leadtime

2018-2019 JEEP WRANGLER JL/JLU SUSPENSION SYSTEMS

ENFORCER SYSTEMS 2.5" 3.5" OR 4.5" LIFT HEIGHTS



JL / JLU ENFORCER SYSTEMS

2.5"	EVO-3011S4	2.5" ENFORCER STAGE 4
	EVO-3011S4P	2.5" ENFORCER STAGE 4 PLUS
	EVO-3011S4K	2.5" ENFORCER STAGE 4, W/ 2.5" DIA KING RESERVOIR SHOCKS
	EVO-3011S4PK	2.5" ENFORCER STAGE 4 PLUS, W/ 2.5" DIA KING RESERVOIR SHOCKS
3.5"	EVO-3013S4	3.5" ENFORCER STAGE 4
	EVO-3013S4P	3.5" ENFORCER STAGE 4 PLUS
	EVO-3013S4K	3.5" ENFORCER STAGE 4, W/ 2.5" DIA KING RESERVOIR SHOCKS
	EVO-3013S4PK	3.5" ENFORCER STAGE 4 PLUS, W/ 2.5" DIA KING RESERVOIR SHOCKS
4.5"	EVO-3054S4	4.5" ENFORCER STAGE 4
	EVO-3054S4P	4.5" ENFORCER STAGE 4 PLUS
	EVO-3054S4K	4.5" ENFORCER STAGE 4, W/ 2.5" DIA KING RESERVOIR SHOCKS
	EVO-3054S4PK	4.5" ENFORCER STAGE 4 PLUS, W/ 2.5" DIA KING RESERVOIR SHOCKS

STAGE 1 "S1", STAGE 2 "S2" STAGE 3 "S3" ALSO AVAILABLE.
REFERENCE STAGE INFORMATION ON PAGE 4.
COMPRESSION ADJUST SHOCKS AVAILABLE- SPECIAL ORDER/LEADTIME

2018-2019 JEEP WRANGLER JL/JLU SUSPENSION SYSTEMS

ENFORCER OVERLAND 2.5" 3.5" OR 4.5" LIFT HEIGHTS



JL / JLU ENFORCER OVERLAND SYSTEMS

2.5"	EVO-3012S4	2.5" ENFORCER OVERLAND STAGE 4
	EVO-3012S4P	2.5" ENFORCER OVERLAND STAGE 4 PLUS
	EVO-3012S4K	2.5" ENFORCER OVERLAND STAGE 4, W/ 2.5" DIA KING RESERVOIR SHOCKS
	EVO-3012S4PK	2.5" ENFORCER OVERLAND STAGE 4 PLUS, W/ 2.5" DIA KING RESERVOIR SHOCKS
3.5"	EVO-3014S4	3.5" ENFORCER OVERLAND STAGE 4
	EVO-3014S4P	3.5" ENFORCER OVERLAND STAGE 4 PLUS
	EVO-3014S4K	3.5" ENFORCER OVERLAND STAGE 4, W/ 2.5" DIA KING RESERVOIR SHOCKS
	EVO-3014S4PK	3.5" ENFORCER OVERLAND STAGE 4 PLUS, W/ 2.5" DIA KING RESERVOIR SHOCKS
4.5"	EVO-3055S4	4.5" ENFORCER OVERLAND STAGE 4
	EVO-3055S4P	4.5" ENFORCER OVERLAND STAGE 4 PLUS
	EVO-3055S4K	4.5" ENFORCER OVERLAND STAGE 4, W/ 2.5" DIA KING RESERVOIR SHOCKS
	EVO-3055S4PK	4.5" ENFORCER OVERLAND STAGE 4 PLUS, W/ 2.5" DIA KING RESERVOIR SHOCKS

STAGE 1 "S1", STAGE 2 "S2" STAGE 3 "S3" ALSO AVAILABLE.
REFERENCE STAGE INFORMATION ON PAGE 4.
COMPRESSION ADJUST SHOCKS AVAILABLE- SPECIAL ORDER/LEADTIME

2018-2019 JEEP WRANGLER JL/JLU SUSPENSION COMPONENTS & UPGRADES

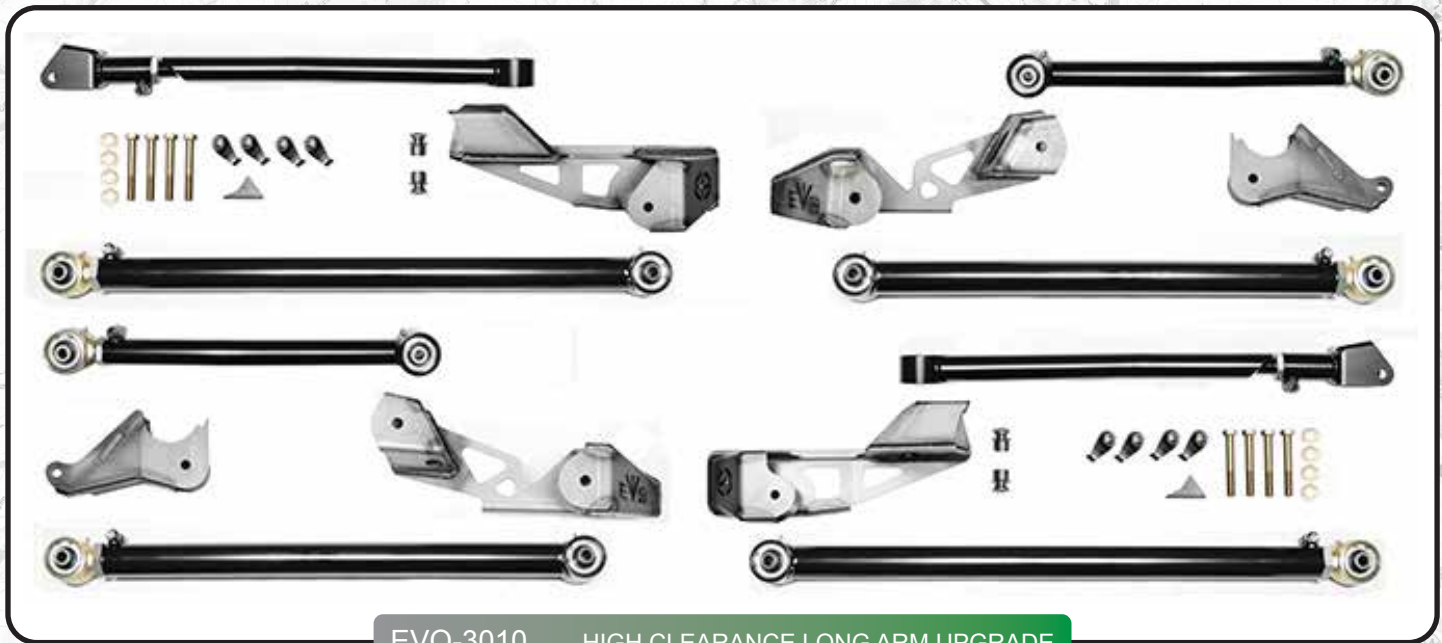

EVO-3010 HIGH CLEARANCE LONG ARM UPGRADE

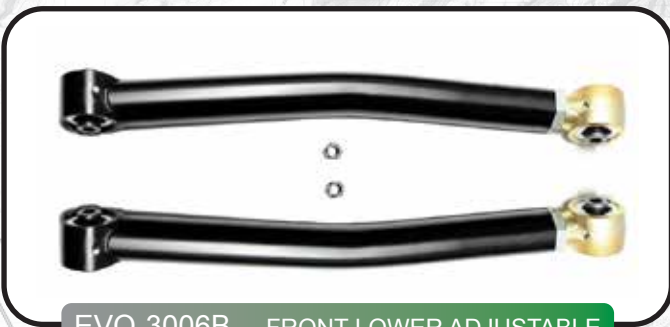

EVO-3006B FRONT LOWER ADJUSTABLE ENFORCER CONTROL ARMS

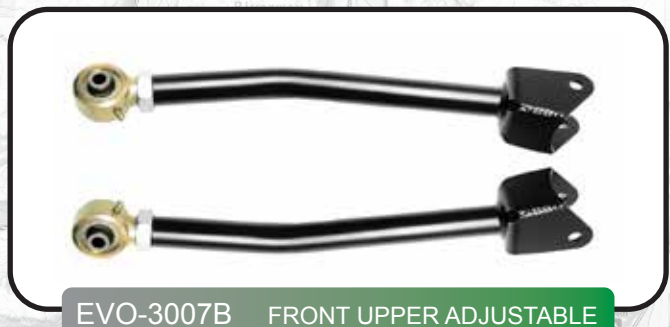

EVO-3007B FRONT UPPER ADJUSTABLE ENFORCER CONTROL ARMS



EVO-1175B REAR LOWER ADJUSTABLE ENFORCER CONTROL ARMS

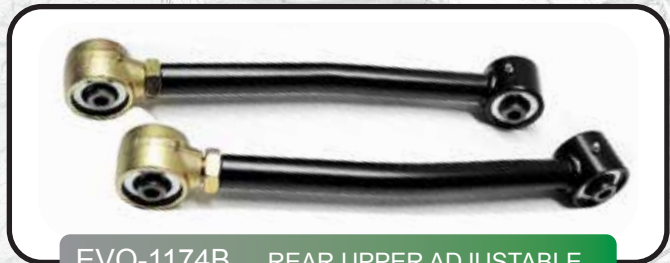

EVO-1174B REAR UPPER ADJUSTABLE ENFORCER CONTROL ARMS



EVO-3047B FRONT ADJUSTABLE TRACKBAR



EVO-3048B REAR ADJUSTABLE TRACKBAR

2018-2019 JEEP WRANGLER JL/JLU SUSPENSION COMPONENTS & UPGRADES

PLUSH RIDE COILS

2.5"	EVO-3021	2.5" FRONT PLUSH RIDE COILS, PAIR
	EVO-3022	2.5" REAR PLUSH RIDE COILS, PAIR
3.5"	EVO-3023	3.5" FRONT PLUSH RIDE COILS, PAIR
	EVO-3024	3.5" REAR PLUSH RIDE COILS, PAIR
4.5"	EVO-3052	4.5" FRONT PLUSH RIDE COILS, PAIR
	EVO-3053	4.5" REAR PLUSH RIDE COILS, PAIR

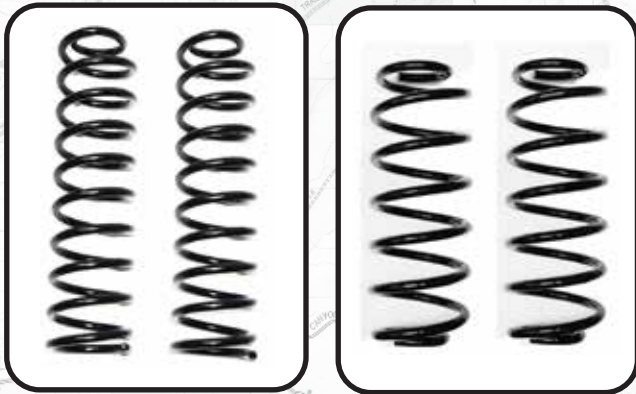

EVO-3003B OVERLAND FRONT GEOMETRY CORRECTION BRACKETS



EVO-1077 FRONT BUMPSTOP EXTENSIONS



EVO-3025B REAR TRACKBAR BRACKET



EVO-1066 REAR BUMPSTOP EXTENSIONS



EVO-3026B PROTEK REAR SHOCK SKIDS



EVO-3027B PROTEK FRONT SHOCK RELOCATION BRACKETS, BLACK

2020 JEEP GLADIATOR JT SUSPENSION SYSTEMS



GLADIATOR JT SUSPENSION SYSTEM STAGE INFORMATION

- | | |
|-----------------|---|
| STAGE 1: | Includes the basic components to lift your Gladiator JT |
| STAGE 2: | Includes all components of stage 1 with the addition of adjustable front Lower enforcer control arms. This allows for front caster adjustments. |
| STAGE 3: | Includes all components of stage 2 with the addition of adjustable rear upper Enforcer control arms. This allows for rear axle pinion angle adjustments |
| STAGE 4: | Includes all component of stage 1 with the addition of "all 8" (Front and rear upper and lower) adjustable enforcer control arms. |

Plus Kits "P" include the addition of front and rear adjustable track bars
"K" Kits include a full set, front and rear king 2.5" dia remote reservoir shocks.
PRO Kits are front and rear coilover suspension systems
Fusion Kits are front coilover rear coil and shock suspension systems

2020 JEEP GLADIATOR JT SUSPENSION SYSTEMS

GLADIATOR JT ENFORCER FUSION SYSTEMS 4.5" OR 6.5" LIFT HEIGHTS



EVO-248BS4P
EVO-249BS4P

4.5" ENFORCER FUSION STAGE 4 PLUS
6.5" ENFORCER FUSION STAGE 4 PLUS

2020 JEEP GLADIATOR JT SUSPENSION SYSTEMS

GLADIATOR JT ENFORCER SYSTEMS 2.5" 4.5" 6.5" LIFT HEIGHTS



GLADIATOR JT ENFORCER SYSTEMS

2.5"	EVO-3060S4	2.5" ENFORCER STAGE 4
	EVO-3060S4P	2.5" ENFORCER STAGE 4 PLUS
	EVO-3060S4K	2.5" ENFORCER STAGE 4, W/ 2.5" DIA KING RESERVOIR SHOCKS
	EVO-3060S4PK	2.5" ENFORCER STAGE 4 PLUS, W/ 2.5" DIA KING RESERVOIR SHOCKS
4.5"	EVO-3062S4	4.5" ENFORCER STAGE 4
	EVO-3062S4P	4.5" ENFORCER STAGE 4 PLUS
	EVO-3062S4K	4.5" ENFORCER STAGE 4, W/ 2.5" DIA KING RESERVOIR SHOCKS
	EVO-3062S4PK	4.5" ENFORCER STAGE 4 PLUS, W/ 2.5" DIA KING RESERVOIR SHOCKS
6.5"	EVO-3064S4	6.5" ENFORCER STAGE 4
	EVO-3064S4P	6.5" ENFORCER STAGE 4 PLUS
	EVO-3064S4K	6.5" ENFORCER STAGE 4, W/ 2.5" DIA KING RESERVOIR SHOCKS
	EVO-3064S4PK	6.5" ENFORCER STAGE 4 PLUS, W/ 2.5" DIA KING RESERVOIR SHOCKS

STAGE 1 "S1", STAGE 2 "S2" STAGE 3 "S3" ALSO AVAILABLE.
REFERENCE STAGE INFORMATION ON PAGE 13.
COMPRESSION ADJUST SHOCKS AVAILABLE- SPECIAL ORDER/LEADTIME

2020 JEEP GLADIATOR JT SUSPENSION SYSTEMS

GLADIATOR JT ENFORCER OVERLAND SYSTEMS 2.5" 4.5" 6.5" LIFT HEIGHTS



GLADIATOR JT ENFORCER OVERLAND SYSTEMS

2.5"	EVO-3061S4	2.5" ENFORCER OVERLAND STAGE 4
	EVO-3061S4P	2.5" ENFORCER OVERLAND STAGE 4 PLUS
	EVO-3061S4K	2.5" ENFORCER OVERLAND STAGE 4, W/ 2.5" DIA KING RESERVOIR SHOCKS
	EVO-3061S4PK	2.5" ENFORCER OVERLAND STAGE 4 PLUS, W/ 2.5" DIA KING RESERVOIR SHOCKS
4.5"	EVO-3063S4	4.5" ENFORCER OVERLAND STAGE 4
	EVO-3063S4P	4.5" ENFORCER OVERLAND STAGE 4 PLUS
	EVO-3063S4K	4.5" ENFORCER OVERLAND STAGE 4, W/ 2.5" DIA KING RESERVOIR SHOCKS
	EVO-3063S4P	4.5" ENFORCER OVERLAND STAGE 4 PLUS, W/ 2.5" DIA KING RESERVOIR SHOCKS
6.5"	EVO-3065S4	6.5" ENFORCER OVERLAND STAGE 4
	EVO-3065S4P	6.5" ENFORCER OVERLAND STAGE 4 PLUS
	EVO-3065S4K	6.5" ENFORCER OVERLAND STAGE 4, W/ 2.5" DIA KING RESERVOIR SHOCKS
	EVO-3065S4PK	6.5" ENFORCER OVERLAND STAGE 4 PLUS, W/ 2.5" DIA KING RESERVOIR SHOCKS

STAGE 1 "S1", STAGE 2 "S2" STAGE 3 "S3" ALSO AVAILABLE.
REFERENCE STAGE INFORMATION ON PAGE 13.
COMPRESSION ADJUST SHOCKS AVAILABLE- SPECIAL ORDER/LEADTIME

2020 JEEP GLADIATOR JT COMPONENTS & UPGRADES

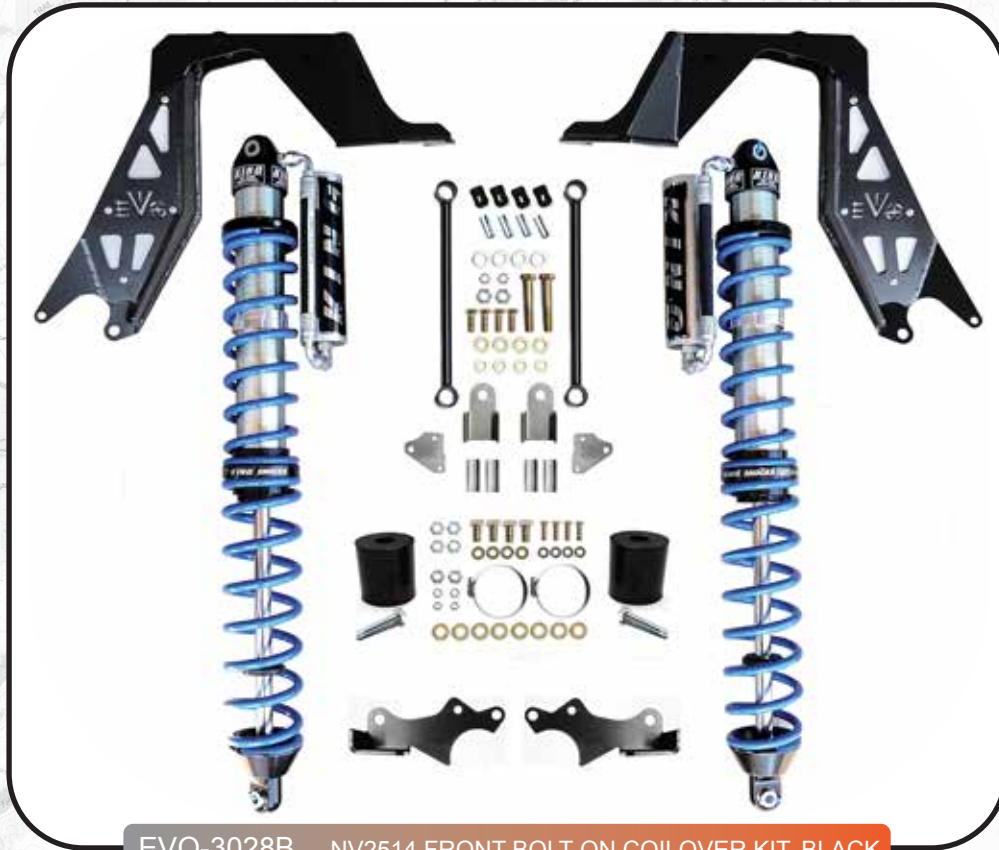

EVO-3028B NV2514 FRONT BOLT-ON COILOVER KIT, BLACK

COMPRESSION ADJUST COILOVERS AVAILABLE, SPECIAL ORDER/LEADTIME

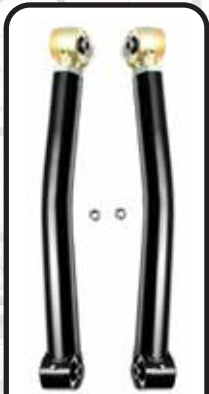

EVO-3006B FRONT LOWER ADJUSTABLE ENFORCER CONTROL ARMS



EVO-3007B FRONT UPPER ADJUSTABLE ENFORCER CONTROL ARMS



EVO-3032B REAR LOWER ADJUSTABLE ENFORCER CONTROL ARMS

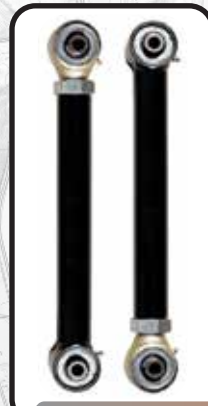

EVO-3081B REAR UPPER ADJUSTABLE ENFORCER CONTROL ARMS



EVO-3047 FRONT ADJUSTABLE TRACKBAR



EVO-3049B REAR ADJUSTABLE TRACKBAR

2020 JEEP GLADIATOR JT COMPONENTS & UPGRADES

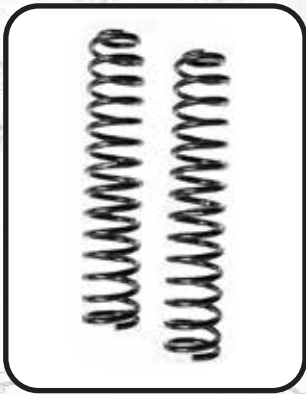

PLUSH RIDE COILS

2.5"	EVO-3068	2.5" FRONT PLUSH RIDE COILS, PAIR
	EVO-3069	2.5" REAR PLUSH RIDE COILS, PAIR
4.5"	EVO-3076	4.5" FRONT PLUSH RIDE COILS, PAIR
	EVO-3077	4.5" REAR PLUSH RIDE COILS, PAIR
6.5"	EVO-3078	6.5" FRONT PLUSH RIDE COILS, PAIR
	EVO-3079	6.5" REAR PLUSH RIDE COILS, PAIR



EVO-3003B OVERLAND FRONT GEOMETRY CORRECTION BRACKETS



EVO-1077 FRONT BUMPS TOP EXTENSIONS

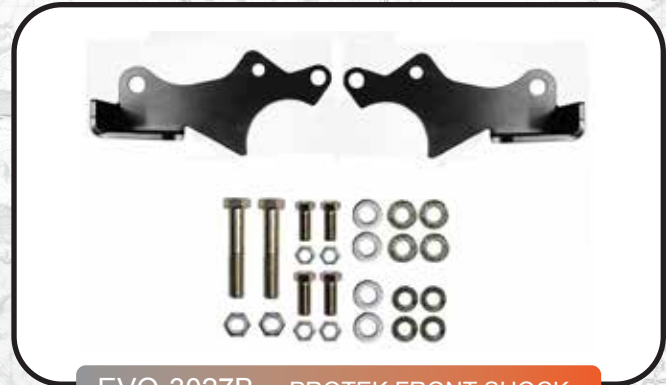

EVO-3027B PROTEK FRONT SHOCK RELOCATION BRACKETS



EVO-3080B-25 2.5" REAR BUMPS TOP EXTENSION PAIR
 EVO-3080B-3 3.0" REAR BUMPS TOP EXTENSION PAIR
 EVO-3080B-4 4.0" REAR BUMPS TOP EXTENSION PAIR

2007-2018 JEEP WRANGLER JK/JKU SUSPENSION SYSTEMS



JK/JKU SUSPENSION SYSTEM STAGE INFORMATION

STAGE 1:

Includes the necessary parts to lift your jk/jku with the addition of adjustable front lower enforcer control arms. This allows for front caster adjustments.

STAGE 2:

Includes all components of stage 2 with the addition of adjustable rear upper enforcer control arms. This allows for rear axle pinion angle adjustments

STAGE 3:

Includes all component of stage 1 with the addition of "all 8" (front and rear upper and lower) adjustable enforcer control arms.

PRO kits are front and rear King coilover suspension systems

2007-2018 JEEP WRANGLER JK/JKU SUSPENSION SYSTEMS

Double Throwdown Component Systems



EVO-1010 FRONT DOUBLE THROWDOWN



EVO-1008 REAR DOUBLE THROWDOWN

2007-2018 JEEP WRANGLER JK/JKU SUSPENSION SYSTEMS

Double Throwdown Long Arm Suspension Systems



EVO-204B DOUBLE THROWDOWN HIGH CLEARANCE LONG ARM

2007-2018 JEEP WRANGLER JK/JKU SUSPENSION SYSTEMS

High Clearance PRO Coilover Long Arm Suspension Systems



EVO-202B HIGH CLEARANCE PRO COILOVER LONG ARM

COMPRESSION ADJUST COILOVERS AVAILABLE - SPECIAL ORDER/LEADTIME

2007-2018 JEEP WRANGLER JK/JKU SUSPENSION SYSTEMS

DOUBLE D LONG ARM SUSPENSION SYSTEMS 3" OR 4" LIFT HEIGHTS



- EVO-1084-35 3" JK/JKU LONG ARM
- EVO-1084-37 4" JK/JKU LONG ARM

2007-2018 JEEP WRANGLER JK/JKU SUSPENSION SYSTEMS

ENFORCER SUSPENSION SYSTEMS 3" OR 4" LIFT HEIGHTS



JK / JKU ENFORCER 3" OR 4" LIFTS

STAGE 1	EVO-230-35S1	3" ENFORCER STAGE 1 WITH DRAGLINK FLIP
STAGE 2	EVO-230-35S2	3" ENFORCER STAGE 2 WITH DRAGLINK FLIP
STAGE 3	EVO-230-35S3	3" ENFORCER STAGE 3 WITH DRAGLINK FLIP
STAGE 1	EVO-230-37S1	4" ENFORCER STAGE 1 WITH DRAGLINK FLIP
STAGE 2	EVO-230-37S2	4" ENFORCER STAGE 2 WITH DRAGLINK FLIP
STAGE 3	EVO-230-37S3	4" ENFORCER STAGE 3 WITH DRAGLINK FLIP

REFERENCE STAGE INFORMATION ON PAGE 19.

2007-2018 JEEP JK/JKU COMPONENTS & UPGRADES

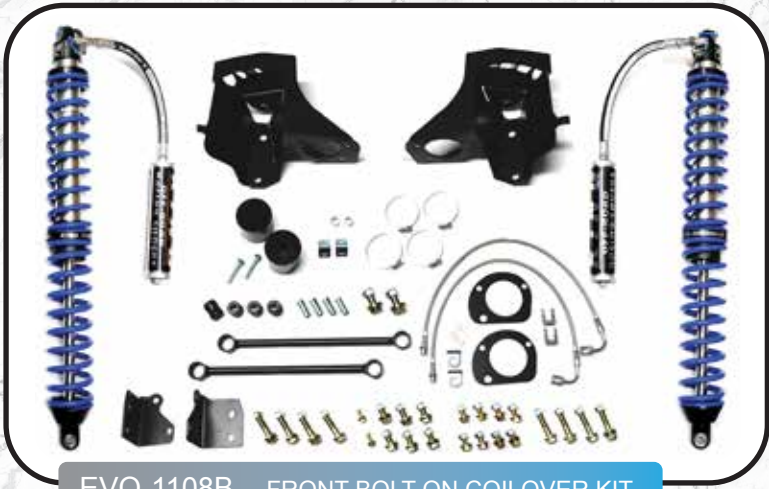

EVO-1108B FRONT BOLT ON COILOVER KIT



EVO-1109B REAR BOLT ON COILOVER KIT



EVO-1200 HIGH CLEARANCE LONG ARM UPGRADE

2007-2018 JEEP JK/JKU COMPONENTS & UPGRADES

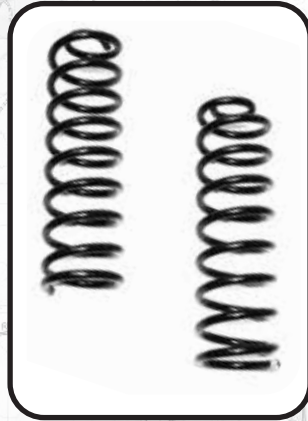
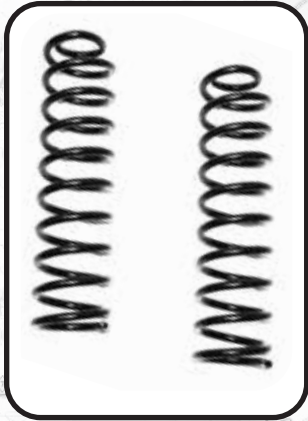

PLUSH RIDE COILS

3"	EVO-1401	3" FRONT PLUSH RIDE SPRING PAIR
	EVO-1402	3" REAR PLUSH RIDE SPRING PAIR
4"	EVO-1061	4" FRONT PLUSH RIDE SPRING PAIR
	EVO-1062	4" REAR PLUSH RIDE SPRING PAIR



EVO-1095 HD LEVELING KIT

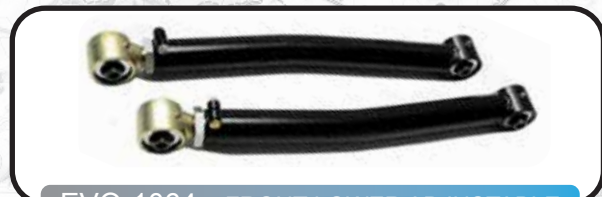

EVO-1064 FRONT LOWER ADJUSTABLE ENFORCER CONTROL ARMS



EVO-1173B FRONT UPPER ADJUSTABLE ENFORCER CONTROL ARMS



EVO-1174B REAR UPPER ADJUSTABLE ENFORCER CONTROL ARMS



EVO-1175B REAR LOWER ADJUSTABLE ENFORCER CONTROL ARMS



EVO-1077 FRONT BUMPSTOP EXTENSIONS



EVO-1066 REAR BUMPSTOP EXTENSIONS



EVO-1071 DRAGLINK FLIP KIT



EVO-1072B REAR RCC TRACKBAR BRACKET

2018-2019 JEEP WRANGLER JL/JLU 2020 JEEP GLADIATOR JT BUMPERS , TIRE CARRIERS & ARMOR



2018-2019 JEEP WRANGLER JL/JLU 2020 JEEP GLADIATOR JT BUMPERS AND TIRE CARRIERS



EVO-3057 ¼ POUNDER FRONT WINCH BUMPER, RAW STEEL
EVO-3057B ¼ POUNDER FRONT WINCH BUMPER, BLACK



EVO-1079 REVOLUTION STINGER FOR ¼ POUNDER
EVO-1079B REVOLUTION STINGER FOR ¼ POUNDER

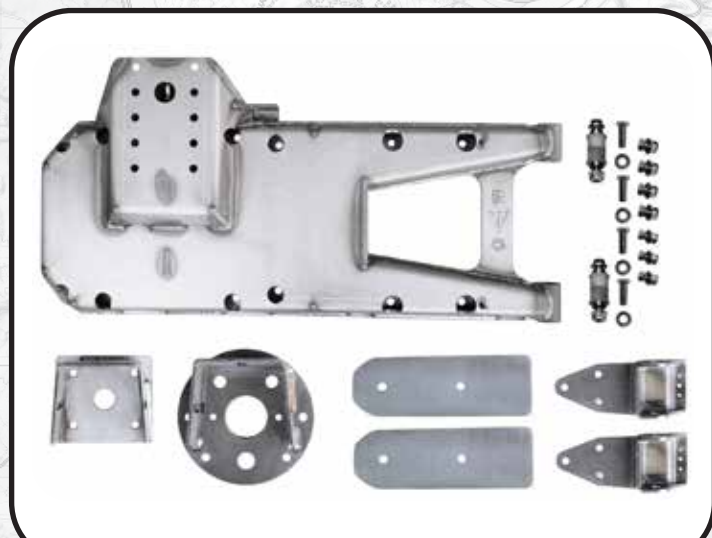

EVO-3032 JL/JLU HD HINGED TIRE CARRIER, RAW
EVO-3032B JL/JLU HD HINGED TIRE CARRIER, BLACK

2018-2019 JEEP WRANGLER JL/JLU 2020 JEEP GLADIATOR JT BUMPERS AND TIRE CARRIERS



EVO-3070 JEEP GLADIATOR JT CREW BOMBER ROCKERS
EVO-3071 JEEP GLADIATOR JT CREW BOMBER ROCKERS WITH ROCK SKINS

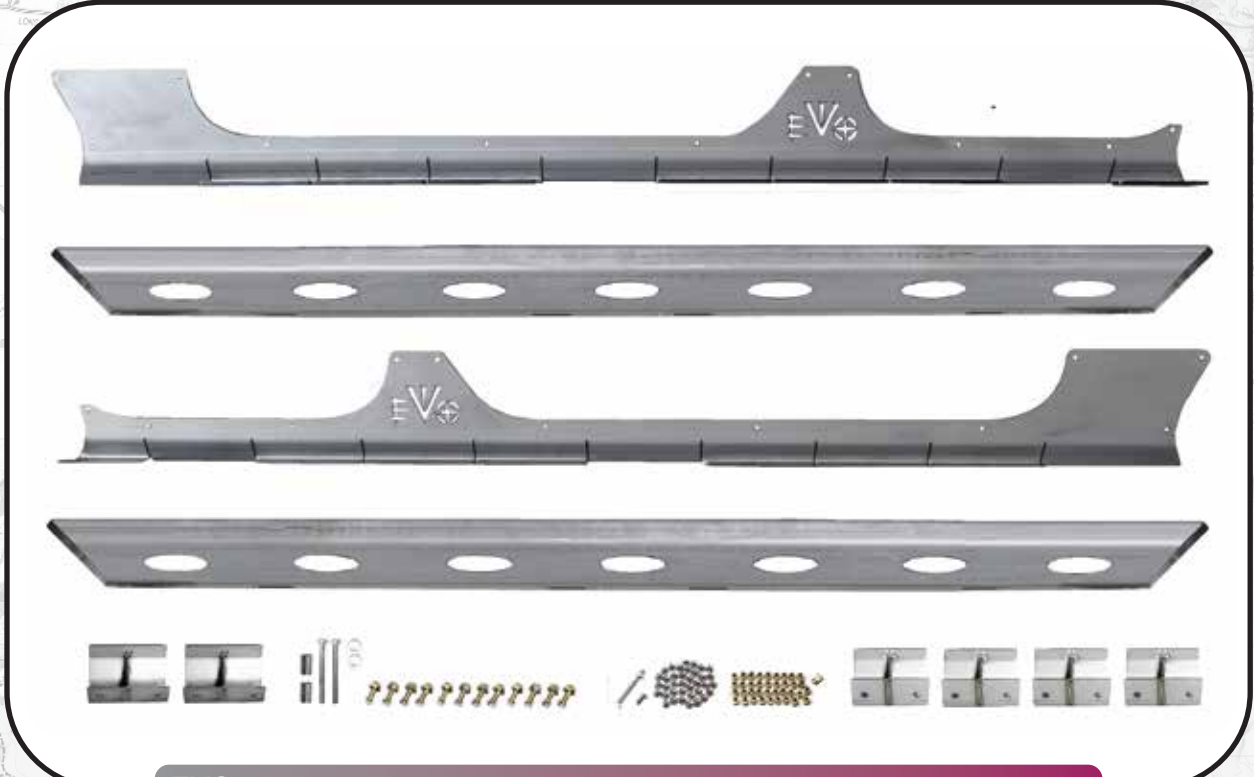

EVO-3033 JEEP WRANGLER JL/.JLU BOMBER ROCKERS
EVO-3036 JEEP WRANGLER JL/.JLU BOMBER ROCKERS WITH ROCK SKINS

2018-2019 JEEP WRANGLER JL/JLU 2020 JEEP GLADIATOR JT BUMPERS AND TIRE CARRIERS



EVO-3039B JL / JLU PROTEK ENGINE AND TRANS SKID BLACK
EVO-3040B JL / JLU PROTEK EXHAUST LOOP SKID BLACK
EVO-3041B JL / JLU PROTEK ENGINE, TRANS, EXHAUST LOOP SKID PACKAGE BLACK

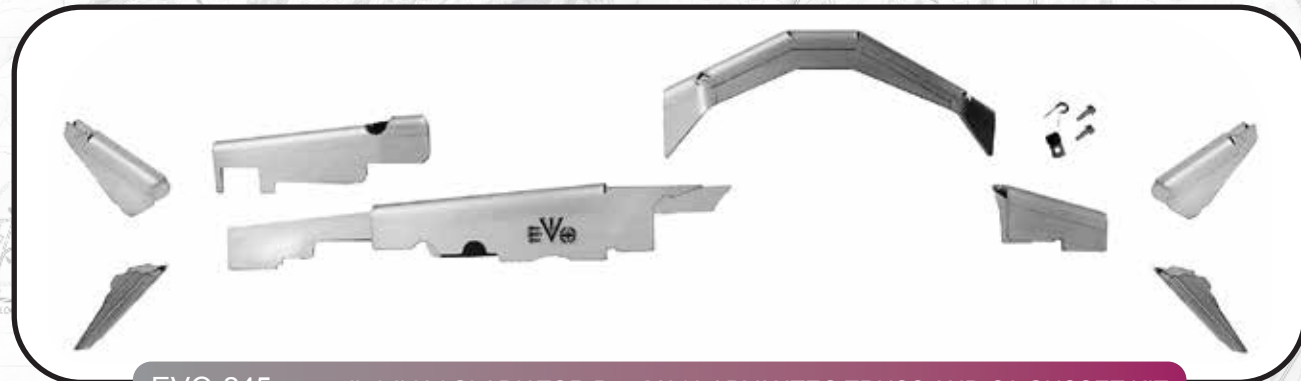

EVO-245 JL / JLU / GLADIATOR D44 M210 ADVANTEC TRUSS AND C2 GUSSET KIT
EVO-3050 JL / JLU / GLADIATOR D44 M210 ADVANTEC TRUSS KIT
EVO-3051 JL / JLU / GLADIATOR ADVANTEC C2 GUSSET KIT



EVO-3042B JL / JLU / GLADIATOR FRONT AXLE FAD/CAD SKID BLACK

2018-2019 JEEP WRANGLER JL/JLU 2020 JEEP GLADIATOR JT BUMPERS AND TIRE CARRIERS

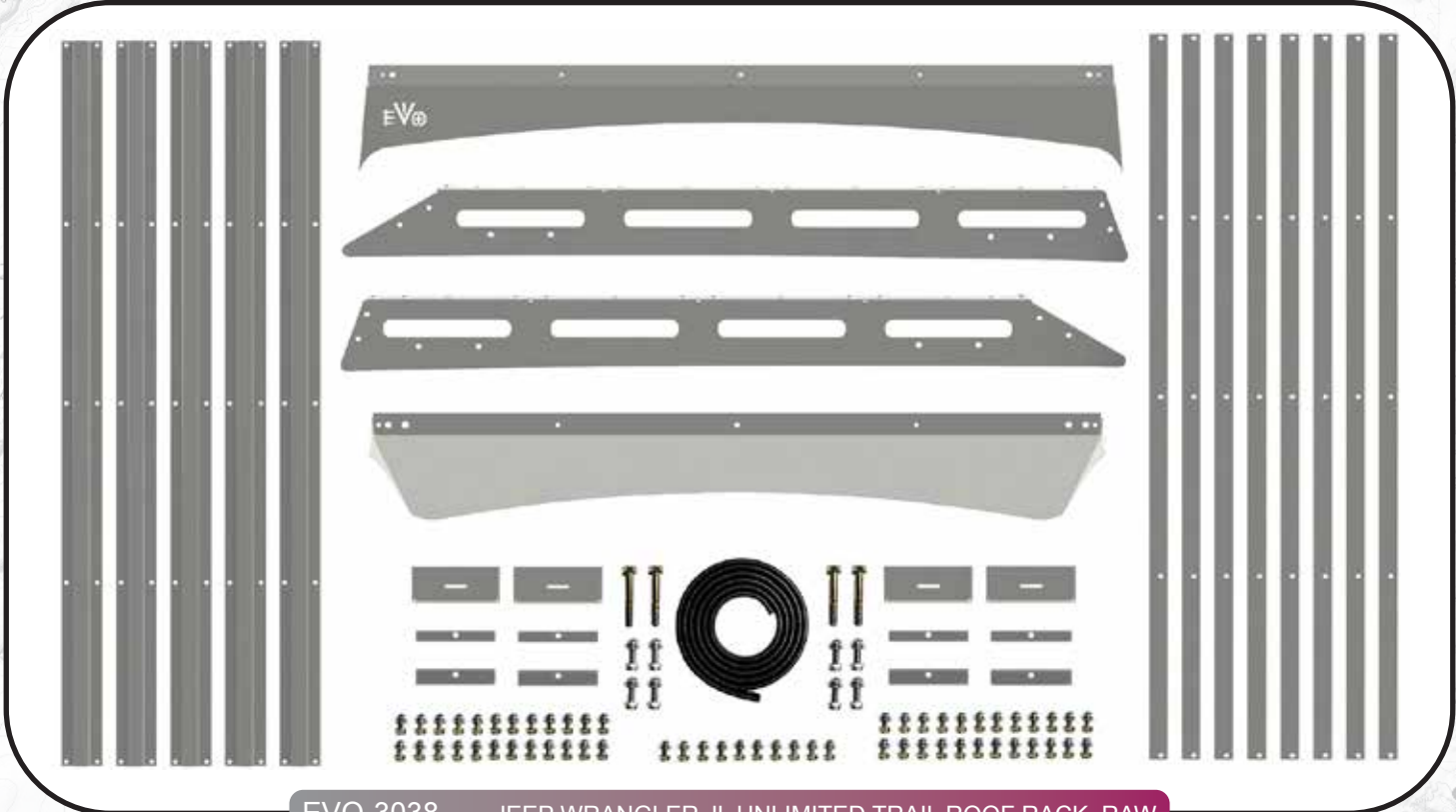

EVO-3038 JEEP WRANGLER JL UNLIMITED TRAIL ROOF RACK, RAW
EVO-3075AL JEEP GLADIATOR JT HALF CAB ROOF RACK, RAW



EVO-3073 MID HEIGHT ADVENTURE BED RACK



EVO-3074 CAB HEIGHT ADVENTURE BED RACK



**2007-2018 JEEP WRANGLER
JK / JKU ACCESSORIES**

2007-2018 JEEP WRANGLER JK/JKU BUMPERS AND TIRE CARRIERS



EVO-3057 1/4 POUNDER FRONT WINCH BUMPER, RAW STEEL
EVO-3057B 1/4 POUNDER FRONT WINCH BUMPER, BLACK



EVO-1130 PRO SERIES FRONT HOOP WINCH BUMPER
EVO-1130NH PRO SERIES FRONT WINCH BUMPER, NO HOOP



EVO-208B REAR DRING AND FACIA PACKAGE KIT BLACK
EVO-1083B REAR BOLT ON D RING SHACKLE MOUNTS BLACK
EVO-1111B REAR BUMPER FASCIA



EVO-1132 PRO SERIES REAR BUMPER



EVO-1079 REVOLUTION STINGER FOR 1/4 POUNDER
EVO-1079B REVOLUTION STINGER FOR 1/4 POUNDER

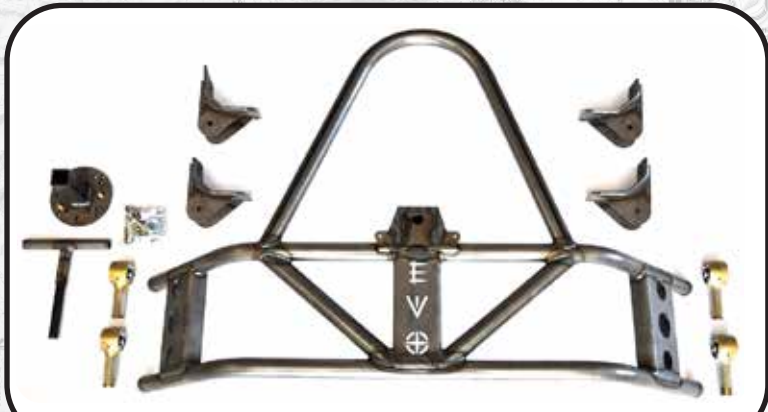

EVO-1069 REAR TIRE CARRIER CAGE

2007-2018 JEEP WRANGLER JK/JKU ARMOR

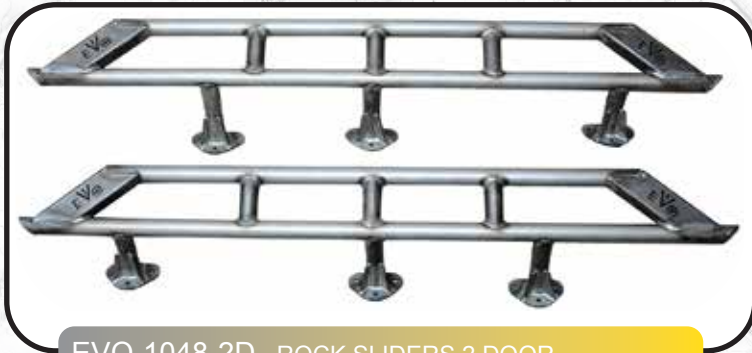

EVO-1048-2D ROCK SLIDERS 2 DOOR
 EVO-1048-4D ROCK SLIDERS 4 DOOR
 EVO-1048-2DSTEP ROCKSLIDER STEP 2 DOOR
 EVO-1048-4DSTEP ROCKSLIDER STEP 4 DOOR



EVO-1070-2D REAR ROCK SKIN 2 DOOR
 EVO-1070-4D REAR ROCK SKIN 4 DOOR

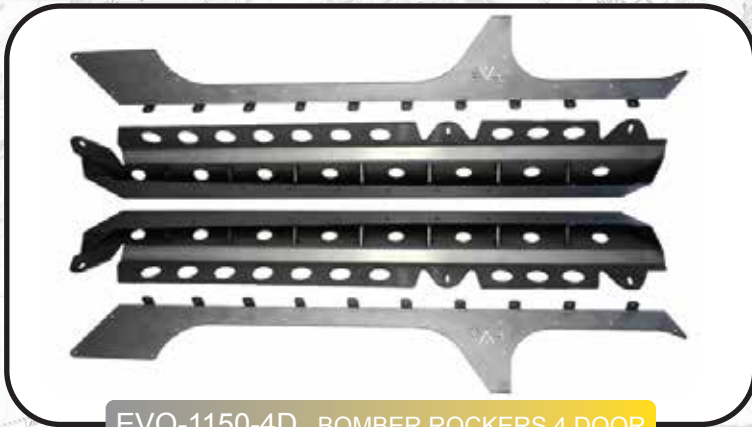

EVO-1150-4D BOMBER ROCKERS 4 DOOR



EVO-1019-4D 4 DOOR REAR BUILDER ARMOR

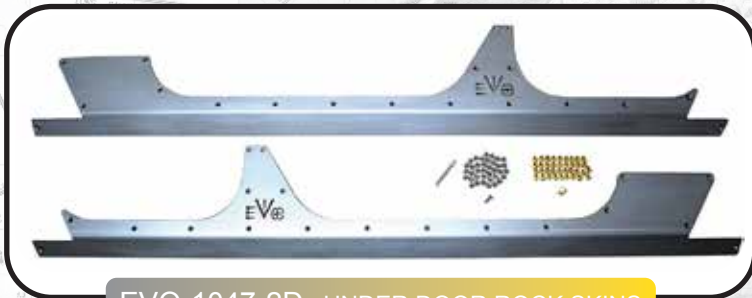

EVO-1047-2D UNDER DOOR ROCK SKINS
 EVO-1047-4D UNDER DOOR ROCK SKINS



EVO-1018 FRONT BUILDER ARMOR

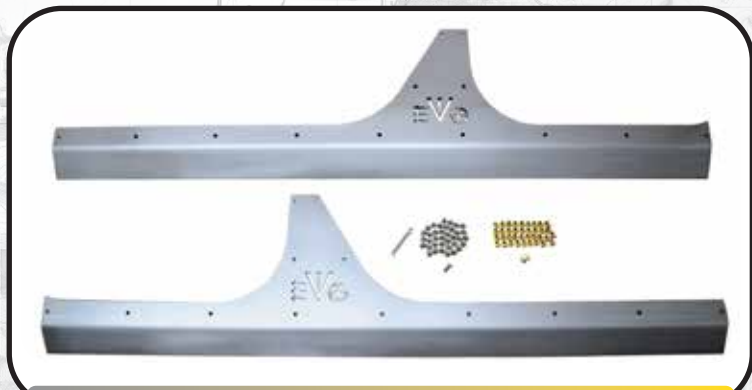

EVO-1021-4D 4 DOOR BUILDER ARMOR UNDER DOOR

2007-2018 JEEP WRANGLER JK/JKU PROTEK ARMOR AND SKIDS



2007-2011 PROTEK SKID SYSTEMS

- EVO-209 3.8L PROTEK ENGINE, TRANS AND EXHAUST SKID PLATES AUTO TRANS
- EVO-210 3.8L PROTEK ENGINE, TRANS AND EXHAUST SKID PLATES MANUAL TRANS
- EVO-209X 3.8L PROTEK PACKAGE AUTO TRANS
- EVO-210X 3.8L PROTEK PACKAGE MANUAL TRANS



2011-2018 PROTEK SKID SYSTEMS

- EVO-211 3.6L PROTEK ENGINE, TRANS AND EXHAUST SKID PLATES AUTO TRANS
- EVO-212 3.6L PROTEK ENGINE, TRANS AND EXHAUST SKID PLATES MANUAL TRANS
- EVO-211X 3.6L PROTEK PACKAGE AUTO TRANS
- EVO-212X 3.6L PROTEK PACKAGE MANUAL TRANS

2007-2018 JEEP WRANGLER JK/JKU PROTEK ARMOR AND SKIDS

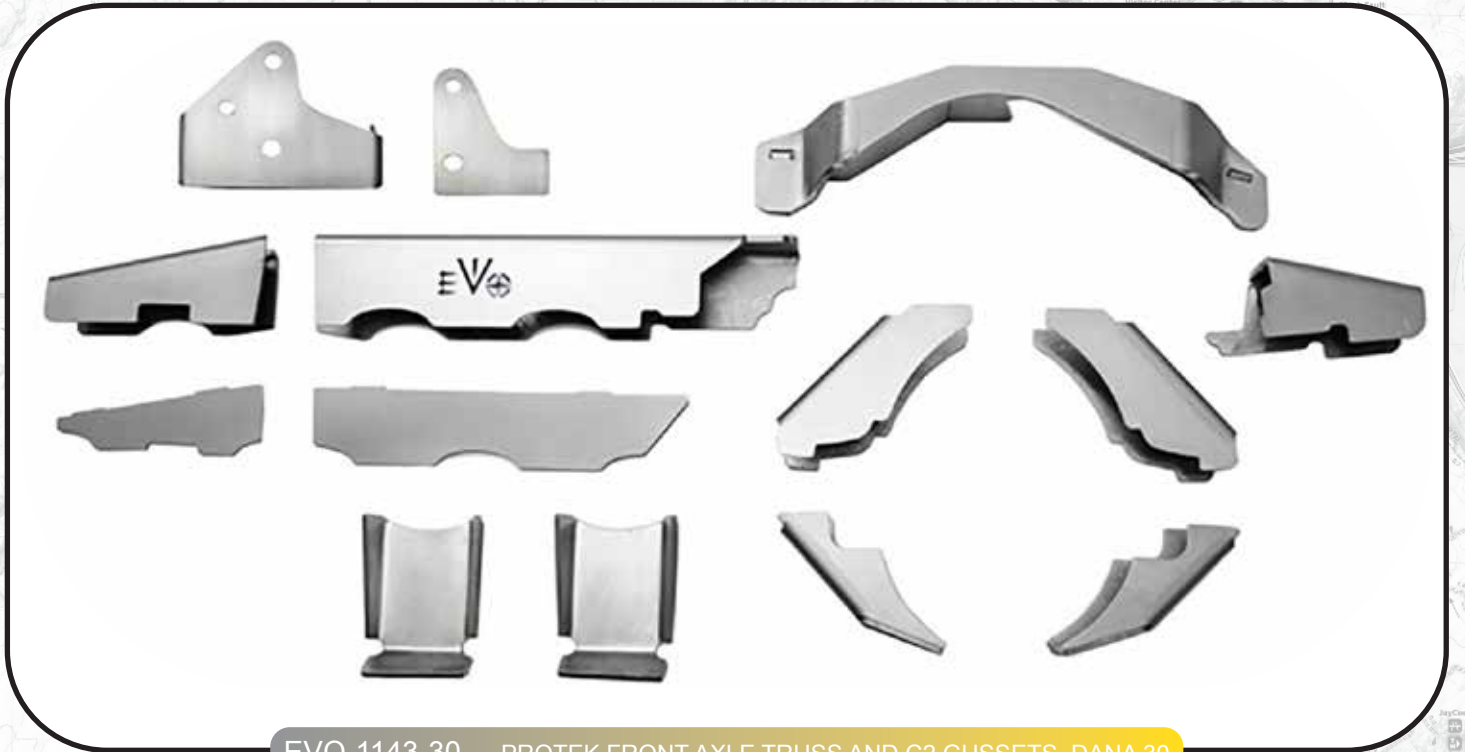

- EVO-1143-30 PROTEK FRONT AXLE TRUSS AND C2 GUSSETS, DANA 30
- EVO-1143-44 PROTEK FRONT AXLE TRUSS AND C2 GUSSETS, DANA 44
- EVO-220-30 PROTEK FRONT AXLE ARMOR TRUSS, DANA 30
- EVO-220-44 PROTEK FRONT AXLE ARMOR TRUSS, DANA 44



EVO-1138 PROTEK REAR AXLE TRUSS

2007-2018 JEEP WRANGLER JK / JKU ACCESSORIES



EVO-1087
NO LIMITS MANUAL RUBICON
SWAYBAR DISCONNECT, JK



EVO-1152
NO LIMITS ON DEMAND SWAY
BAR DISCONNECT



EVO-1097
ARB AIR COMPRESSOR
MOUNT KIT



EVO-1197
VENTED INNER FENDERS,
COIL SPRING SUSPENSION



EVO-1198
VENTED INNER FENDER
LINERS, COILOVER



EVO-1199
VENTED INNER FENDER LINERS,
DOUBLE THROWDOWN



EVO-1120B
TAILGATE JACK MOUNT BLACK



EVO-1163B
LICENSE PLATE RELOCATE



EVO-214
MINI INNER FENDER LINERS