

AI 5X/20X/23X PTZ Bullet Plus Network Camera



IP66

AF Lens



DATASHEET

KEY FEATURES

- ▶ Smart IR II (Combining the High Beam and Low Beam to adjust IR intensity for different lighting conditions with the IR distance up to 180m.)
- ▶ 1/1.8" Starlight Sensor (The STARVIS Starlight big sensor enables the camera to deliver clear night image quality.)
- ▶ PTZ Auto Tracking (Perform Pan/Tilt/Zoom to track the moving objects in a proper size automatically.)
- ▶ 300 Preset Positions (The user can easily control the lens position via mouse to monitor interested area and set up to 300 preset positions for patrolling.)
- ▶ Versatile Interfaces (A whole array of ports including PoE, DC, Audio I/O and Alarm I/O offers more choices for easy management and various needs.)
- ▶ New-generation PTZ Motor (The new generation motor is designed with sophisticate planetary gear drive to ensure smooth turning and robust performance.)
- ▶ Keyboard Control (Shortcut keys for PTZ control via Keyboard.)
- ▶ Smart Stream (Bandwidth, storage and bit rate save with Smart Stream ON, e.g. H.265+ save 70%~80% bandwidth of H.264.)

AI Video Analytics

- 8 intelligent VCA modes powered by AI engine, which can intelligently filter objects to focus on human and vehicle detection.
- People Counting technology provides high accuracy and real-time data based on AI algorithm with statistic reports.
- Face Detection function detects human faces in the monitoring scene and captures the snapshots, which greatly enhances the monitoring efficiency.



3 in 1 Super WDR Pro & 0.002Lux Ultra Low-light

140dB Super WDR Pro combines 3 frames with multiple exposures to get the optimal images especially moving subjects in high contrast lighting situations. Meanwhile, the cameras can capture full-color images in extremely low-light conditions reaching 0.002Lux without extra light supplement.

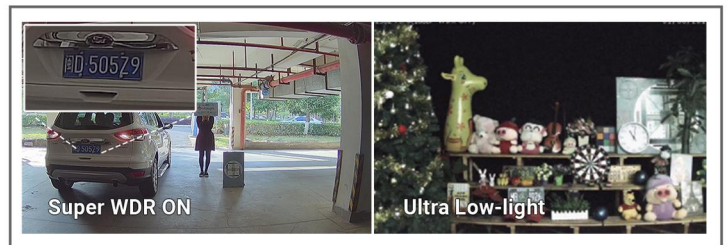

23X Optical Zoom

The 23X optical zoom can zoom up to distant subjects while still maintaining the clarity, delivering high quality video over the entire zoom range.

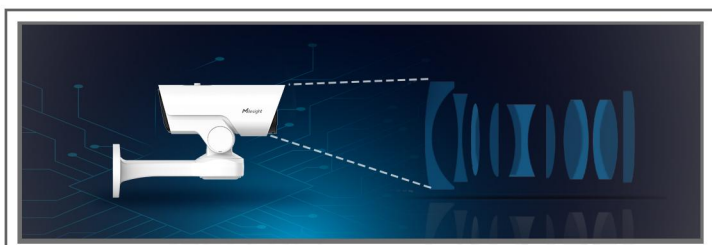

30fps@4K

Providing 4K HD resolution with frame rate of 30fps, the camera performs well in catching detailed image regardless of the moving speed.

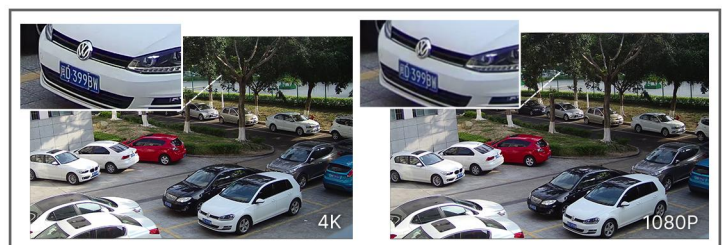

AI 5X/20X/23X PTZ Bullet Plus Network Camera



	Model	MS-C2867-X20TPC (2MP)	MS-C2967-X23R(T)PC (2MP)	MS-C5367-X23PC (5MP)
Camera	Image Sensor	1/2" Progressive Scan CMOS	1/2.8" Progressive Scan CMOS	
	Min. Illumination	Color: 0.002Lux@F1.6 B/W: 0Lux with IR on	Color: 0.005Lux@F1.5 B/W: 0Lux with IR on	Color: 0.008Lux@F1.5 B/W: 0Lux with IR on
	WDR	140dB Super WDR Pro	140dB Super WDR (Super WDR Pro is optional for T Series)	120dB Super WDR
	Shutter Time	1/100000s~1s		
	IR Distance	Up to 180m		
	Digital Zoom	16X		
	Day/Night Mode	Day/Night/Auto/Customize/Schedule		
	S/N	>55dB		
Lens	Focal Length	6.4~128mm, 20X Optical Zoom	5~117mm, 23X Optical Zoom	5~117mm, 23X Optical Zoom
	Zoom Speed	Approx 5s (Wide-Tele)	Approx 6s (Wide-Tele)	Approx 6s (Wide-Tele)
	Field of View	H60°~H3°/D67°~D4°/ V37°~V1°	H60°~H3°/D69°~D4°/ V35°~V2°	H55°~H3°/D68°~D4°/ V42°~V2°
	Focus Control	Auto/Semi-Auto/Manual		
	Minimum Working Distance	1000/2000mm (Wide/Tele)	1000/1500mm (Wide/Tele)	1000/1500mm (Wide/Tele)
	Aperture	F1.6~F4.0	F1.5~F3.5	F1.5~F3.5
	Iris Control	Auto		
	PTZ	Pan Range/Pan Speed	360°endless / Pan Manual Speed: 0.1°~60°/s, Pan Preset Speed: 60°/s	
Tilt Range/Tilt Speed		-45°~30° / Tilt Manual Speed: 0.1°~30°/s, Tilt Preset Speed: 30°/s		
Proportional Zoom		Support		
Preset Quantity		300		
Patrol		8 Patrols, up to 48 presets each patrol		
Pattern		4 Patterns		
Auto Tracking		Support		
Power Off Memory		Support		
Other Function	Auto Scan, Auto Home, Preset Freezing, 3D Positioning, PTZ Limits, Initial Position			
Video	Max. Image Resolution	1920x1080		2592x1944
	Primary Stream	60Hz: 100fps@(1920x1080)(Optional for T Series) , 60fps@(1920x1080, 1280x960, 1280x720, 704x576) 50Hz: 100fps@(1920x1080)(Optional for T Series) , 50fps@(1920x1080, 1280x960, 1280x720, 704x576)		60Hz: 30fps@(2592x1944), 45fps@(2048x1536), 60fps@(1920x1080, 1280x960, 1280x720, 704x576) 50Hz: 25fps@(2592x1944), 45fps@(2048x1536), 50fps@(1920x1080, 1280x960, 1280x720, 704x576)
	Secondary Stream	60Hz: 60fps@(704x576, 640x480, 640x360, 352x288, 320x240, 320x192, 320x180) 50Hz: 50fps@(704x576, 640x480, 640x360, 352x288, 320x240, 320x192, 320x180)		60Hz: 30fps@(704x576, 640x480, 640x360, 352x288, 320x240, 320x192, 320x180) 50Hz: 25fps@(704x576, 640x480, 640x360, 352x288, 320x240, 320x192, 320x180)
	Tertiary Stream	60Hz: 30fps@(1920x1080, 1280x720, 704x576, 640x480, 640x360, 320x240, 320x192, 320x180) 50Hz: 25fps@(1920x1080, 1280x720, 704x576, 640x480, 640x360, 320x240, 320x192, 320x180)		
	Video Compression	H.265+/H.265(HEVC)/H.264+/H.264/MJPEG		
	Video Bit Rate	16Kbps~16Mbps(CBR/VBR Adjustable)		

AI 5X/20X/23X PTZ Bullet Plus Network Camera



Video	Privacy Masking	Up to 28 areas(24 mask areas and 4 mosaic areas)
	ROI	Up to 8 areas
	Image Setting	Brightness/Contrast/Saturation/Sharpness
Interface	Ethernet	1*RJ45 10M/100M Ethernet Port
	Audio I/O	1/1
	Alarm I/O	1/1
Network	Network Storage	NAS(Support NFS, SMB/CIFS), ANR
	Protocol	IPv4/IPv6, ARP, TCP, UDP, RTCP, RTP, RTSP, RTMP, HTTP, HTTPS, DNS, DDNS, DHCP, FTP, NTP, SMTP, SNMP, UPnP, Bonjour, SIP, PPPoE, VLAN, 802.1x, QoS, IGMP, ICMP, SSL
Audio	Audio Compression	G.711/AAC/G.722/G.726
	Audio Sampling Rate	8/16/32/44.1/48KHz
	Audio Bit Rate	16~256kbps
	Two-way Audio	Support
Intelligent Analytics	Video Analysis	Region Entrance, Region Exiting, Advanced Motion Detection, Tamper Detection, Line Crossing, Loitering, Object Left, Object Removed
	Face Detection	Detect and capture faces, get real-time snapshots
	People Counting&Report	Count the number of people entering or exiting, up to 4 detection areas for regional people counting
System	Storage	Support microSD/SDHC/SDXC Card Local Storage, up to 256G
	Advanced Function	BLC, HLC, 2D DNR, 3D DNR, Defog, AWB, EIS, IP Address Filtering, AGC, Anti-flicker, Corridor Mode, Deblur, Watermark
	SIP/VoIP Support	Yes, Voice & Video-over-IP
	Event Trigger	Motion Detection, Network Disconnection, External Input, Audio Alarm, etc.
	Event Action	FTP Upload, SMTP Upload, SD Card Record, External Output, SIP Phone, White LED, PTZ Motion, HTTP Notification, etc.
	System Compatibility	ONVIF Profile G & Q & S & T, API
General	Working Temperature	-40°C~60°C
	Working Humidity	0~90%(Non-condensing)
	Power Supply	PoE (802.3at) / DC 12V/3A±10%
	Power Consumption	12W MAX / 23W MAX (With IR on)
	Weather Proof	Up to IP66-rated for Weather-resistant Performance
	Weight	2.9Kg
	Dimensions	110mmX337mmX220mm
	Warranty	2 Years / 3 Years (Optional)

AI 5X/20X/23X PTZ Bullet Plus Network Camera



	Model	MS-C8267-X5PC (4K)	MS-C8267-X20PC (4K)
Camera	Image Sensor	1/1.8" Progressive Scan CMOS	
	Min. Illumination	Color: 0.009Lux@F1.7 B/W: 0Lux with IR on	Color: 0.009Lux@F1.6 B/W: 0Lux with IR on
	WDR	120dB Super WDR	
	Shutter Time	1/100000s~1s	
	IR Distance	Up to 180m	
	Digital Zoom	16X	
	Day/Night Mode	Day/Night/Auto/Customize/Schedule	
	S/N	>55dB	
Lens	Focal Length	11~55mm, 5X Optical Zoom	6.4~128mm, 20X Optical Zoom
	Zoom Speed	Approx 3.5s (Wide-Tele)	Approx 5s (Wide-Tele)
	Field of View	H36°~H8°/D41°~D9°/ V21°~V5°	H60°~H3°/D67°~D4°/ V37°~V1°
	Focus Control	Auto/Semi-Auto/Manual	
	Minimum Working Distance	1000/1500mm (Wide/Tele)	1000/2000mm (Wide/Tele)
	Aperture	F1.7~F2.1	F1.6~F4.0
	Iris Control	Auto	
PTZ	Pan Range/Pan Speed	360°endless / Pan Manual Speed: 0.1°~60°/s, Pan Preset Speed: 60°/s	
	Tilt Range/Tilt Speed	-45°~30° / Tilt Manual Speed: 0.1°~30°/s, Tilt Preset Speed: 30°/s	
	Proportional Zoom	Support	
	Preset Quantity	300	
	Patrol	8 Patrols, up to 48 presets each patrol	
	Pattern	4 Patterns	
	Auto Tracking	Support	
	Power Off Memory	Support	
	Other Function	Auto Scan, Auto Home, Preset Freezing, 3D Positioning, PTZ Limits, Initial Position	
Video	Max. Image Resolution	3840x2160	
	Primary Stream	60Hz: 30fps@(3840x2160, 3072x2048, 2592x1944, 2592x1520, 2048x1536, 1920x1080, 1280x960, 1280x720, 704x576) 50Hz: 25fps@(3840x2160, 3072x2048, 2592x1944, 2592x1520, 2048x1536, 1920x1080, 1280x960, 1280x720, 704x576)	
	Secondary Stream	60Hz: 30fps@(704x576, 640x480, 640x360, 352x288, 320x240, 320x192, 320x180) 50Hz: 25fps@(704x576, 640x480, 640x360, 352x288, 320x240, 320x192, 320x180)	
	Tertiary Stream	60Hz: 30fps@(1920x1080, 1280x720, 704x576, 640x480, 640x360, 320x240, 320x192, 320x180) 50Hz: 25fps@(1920x1080, 1280x720, 704x576, 640x480, 640x360, 320x240, 320x192, 320x180)	
	Video Compression	H.265+/H.265(HEVC)/H.264+/H.264/MJPEG	
	Video Bit Rate	16Kbps~16Mbps(CBR/VBR Adjustable)	
	Privacy Masking	Up to 28 areas(24 mask areas and 4 mosaic areas)	
	ROI	Up to 8 areas	
	Image Setting	Brightness/Contrast/Saturation/Sharpness	

AI 5X/20X/23X PTZ Bullet Plus Network Camera



Interface	Ethernet	1*RJ45 10M/100M Ethernet Port
	Audio I/O	1/1
	Alarm I/O	1/1
Network	Network Storage	NAS(Support NFS, SMB/CIFS), ANR
	Protocol	IPv4/IPv6, ARP, TCP, UDP, RTCP, RTP, RTSP, RTMP, HTTP, HTTPS, DNS, DDNS, DHCP, FTP, NTP, SMTP, SNMP, UPnP, Bonjour, SIP, PPPoE, VLAN, 802.1x, QoS, IGMP, ICMP, SSL
Audio	Audio Compression	G.711/AAC/G.722/G.726
	Audio Sampling Rate	8/16/32/44.1/48KHz
	Audio Bit Rate	16~256kbps
	Two-way Audio	Support
Intelligent Analytics	Video Analysis	Region Entrance, Region Exiting, Advanced Motion Detection, Tamper Detection, Line Crossing, Loitering, Object Left, Object Removed
	Face Detection	Detect and capture faces, get real-time snapshots
	People Counting&Report	Count the number of people entering or exiting, up to 4 detection areas for regional people counting
System	Storage	Support microSD/SDHC/SDXC Card Local Storage, up to 256G
	Advanced Function	BLC, HLC, 2D DNR, 3D DNR, Defog, AWB, EIS, IP Address Filtering, AGC, Anti-flicker, Corridor Mode, Deblur, Watermark
	SIP/VoIP Support	Yes, Voice & Video-over-IP
	Event Trigger	Motion Detection, Network Disconnection, External Input, Audio Alarm, etc.
	Event Action	FTP Upload, SMTP Upload, SD Card Record, External Output, SIP Phone, White LED, PTZ Motion, HTTP Notification, etc.
	System Compatibility	ONVIF Profile G & Q & S & T, API
General	Working Temperature	-40°C~60°C
	Working Humidity	0~90%(Non-condensing)
	Power Supply	PoE (802.3at) / DC 12V/3A±10%
	Power Consumption	13W MAX / 24W MAX (With IR on)
	Weather Proof	Up to IP66-rated for Weather-resistant Performance
	Weight	2.9Kg
	Dimensions	110mmX337mmX220mm
	Warranty	2 Years / 3 Years (Optional)

AI 5X/20X/23X PTZ Bullet Plus Network Camera



Structure Diagrams

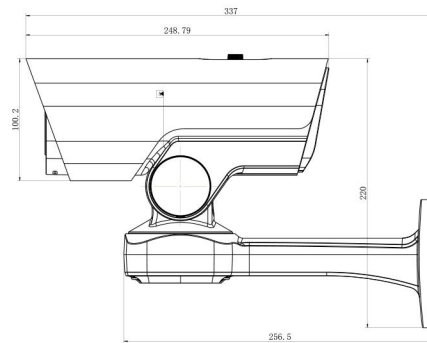
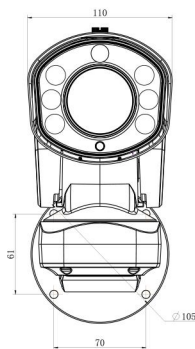
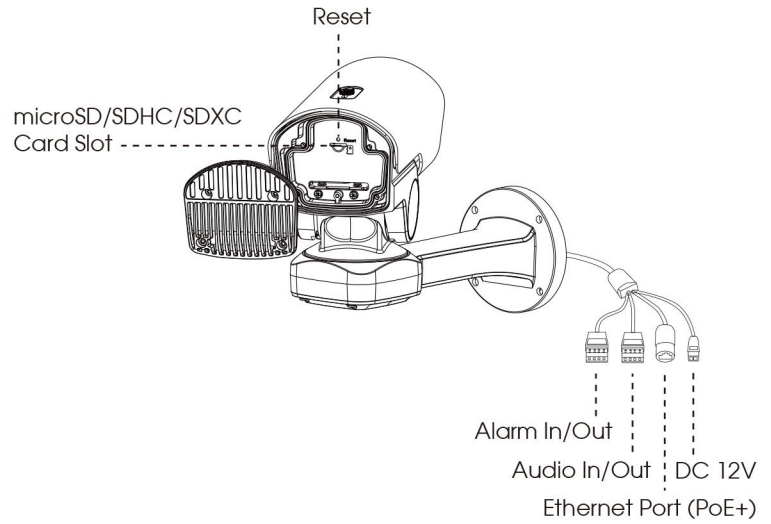
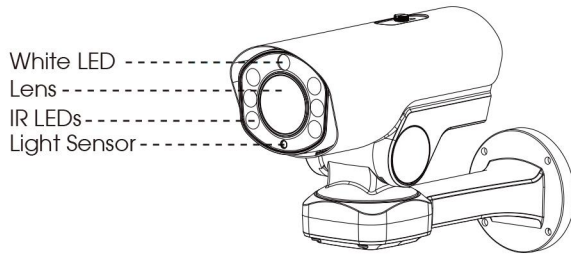

Units: mm

Accessories Support

A01 Pole Mount

Weight: 720g
Dimensions: 170*51.5*152.6mm



A03 External Corner Bracket

Weight: 900g
Dimensions: 170*152.5*76.3mm



A62 Junction Box

Weight: 510g
Dimensions: 134*126*40mm



Milesight Technology | www.milesight.com
Contact Us: sales@milesight.com support@milesight.com

Add: 220 NE 51st Street, Oakland
Park, Florida 33334, USA
Tel: +1-800-561-0485

Add: 925, Anyang SK V1 Center, LS-ro
116beon-gil, Dongan-gu, Anvng-si, Korea
Tel: +82-31-990-7732

Add: Building C09, Software Park
Phase III, Xiamen 361024, Fujian, China
Tel: +86-592-5922772

