

# C42 Ceiling PoE Line

## Ceiling bt PoE Switches

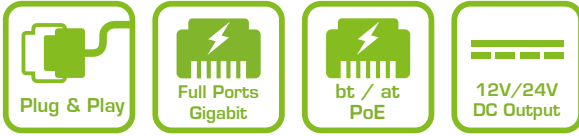

AETEK's unmanaged C42-050-030 Ceiling PoE Switch line with one PoE PD input port, five PoE PSE output ports, and visible LED indicator benefits from low-cost installation quick diagnostic, and low-voltage safety DC power deployment. C42-050-30-B unparalleled daisy-chain PoE feature extends long range PoE up to 300m over cat 5e/cat 6 cable without extra AC/DC power adapter in ceiling. Furthermore C42-050-30-B provides DC 12V & DC 24V output for non-IP DC device.

### Features

- No costly electrical installation required
- Eliminating conventional electrical supply reducing the fire event in the ceiling
- No need to switch off the power anywhere when PoE or non-PoE device is expanded or changed in ceiling
- Supports 10/100/1000Mbps data rates
- Support Auto-MDI/MDIX
- IEEE 802.3az Energy Efficient Ethernet standard for green power

### Applications

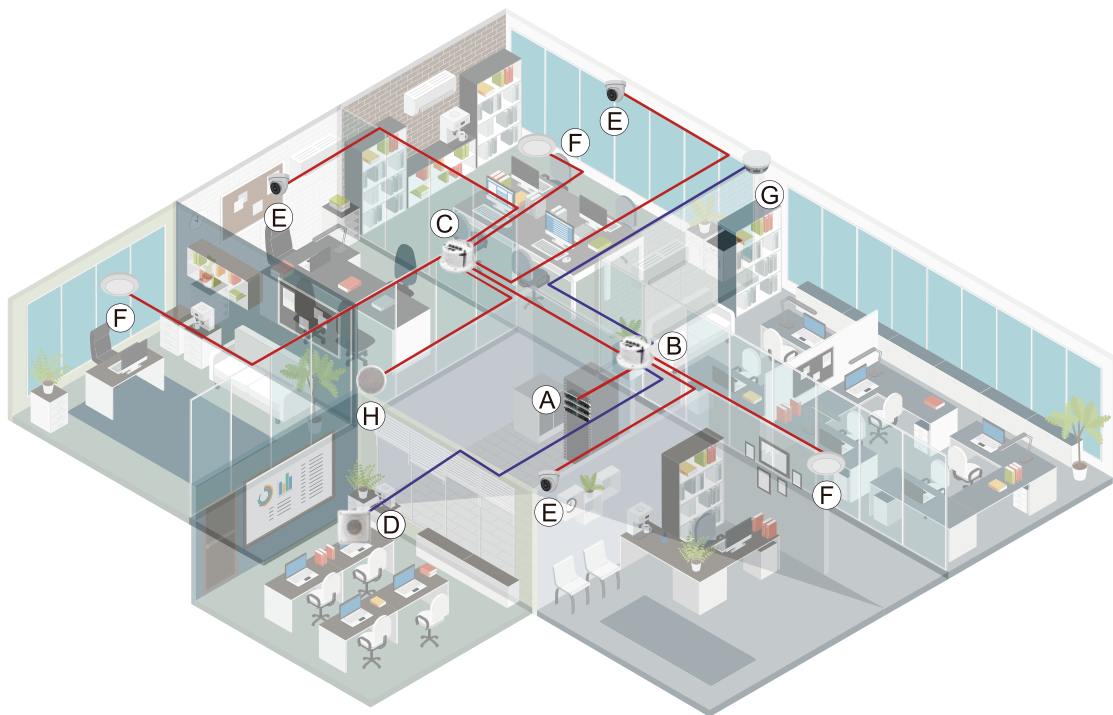

PoE (Data + Power) ——— DC Power ———

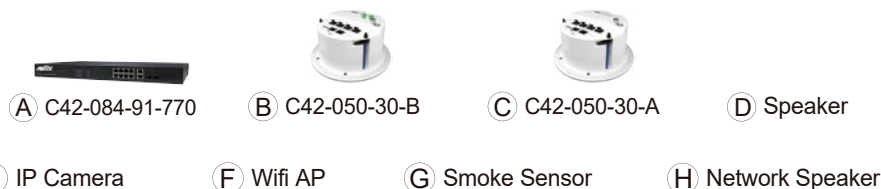

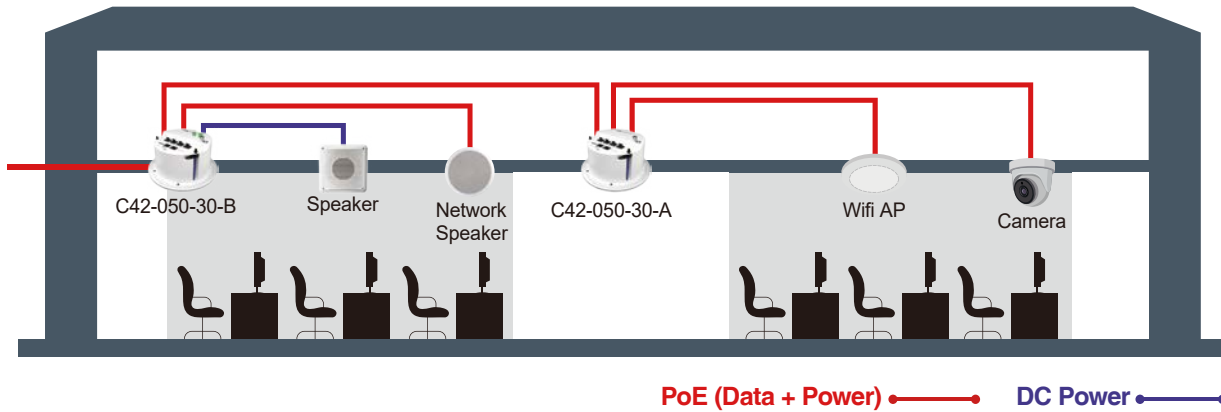





## Technical Specifications-Hardware

	C42-050-30-A	C42-050-30-B
<b>Network Specifications</b>		
GbE PoE PSE Ports	1 x bt PoE Output 4 x at PoE Output	1 x bt PoE Output 4 x at PoE Output
GbE PoE PD Port	1 x bt PD Input	1 x bt PD Input
Power Input	Class 8 bt PoE	Class 8 bt PoE
Daisy-Chain	-	Support
Reset Button	Support	Support
Power Output	-	12VDC/2.5A x 1, 2Pin Terminal Block 24VDC/1.25A x 1, 2Pin Terminal Block
Forwarding Capacity	8.928Mpps	8.928Mpps
Mac Table	8 K	8 K
Jumbo Frames	9,216 Bytes	9,216 Bytes
Switching Capacity	12 Gbps	12 Gbps
LED Indicator	PWR, LAN, PoE	PWR, LAN, PoE, 12VDC, 24VDC
<b>Mechanical Specifications</b>		
Dimensions	H90×φ185.16 mm	H90×φ185.16 mm
Recommended ceiling opening	φ150 mm	φ150 mm
Recommended ceiling thickness	5 to 45 mm	5 to 45 mm
Case material	PC	PC
Weight	0.8KG	1KG
<b>Environmental Specifications</b>		
Operating Temperature	0°C ~ 50°C (32°F ~ 122°F)	0°C ~ 50°C (32°F ~ 122°F)
Storage Temperature	-20°C ~ 70°C (-4°F ~ 158°F)	-20°C ~ 70°C (-4°F ~ 158°F)
Operating Humidity	10% to 90% non-condensing	10% to 90% non-condensing
<b>Certifications</b>		
EMC	CE, FCC, VCCI, C-Tick	CE, FCC, VCCI, C-Tick

## Ordering Information

Ceiling PoE Switch Line			
	<b>C42-050-30-A</b> <ul style="list-style-type: none"> <li>1xGbE bt PD PoE Input</li> <li>1xGbE bt PoE + 4xGbE at PoE PSE Output</li> </ul>		<b>C42-050-30-B</b> <ul style="list-style-type: none"> <li>1xGbE bt PD PoE Input</li> <li>1xGbE bt PoE + 4xGbE at PoE PSE Output</li> <li>12V/24VDC Output</li> <li>Support Daisy-Chain</li> </ul>

## Related Product

bt PoE Switch Line			
	<b>C42-042-91-380</b> <ul style="list-style-type: none"> <li>4xGbE bt PoE + 2xGbE Switch</li> <li>380W Power Budget</li> </ul>		<b>C42-084-91-770</b> <ul style="list-style-type: none"> <li>8xGbE bt PoE + 2xGbE RJ45 + 2xGbE SFP Switch</li> <li>770W Power Budget</li> </ul>