

TOOLS REQUIRED

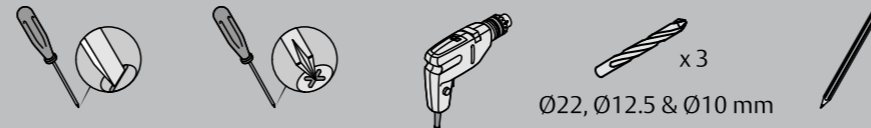

1 LOCKSET HANDLING

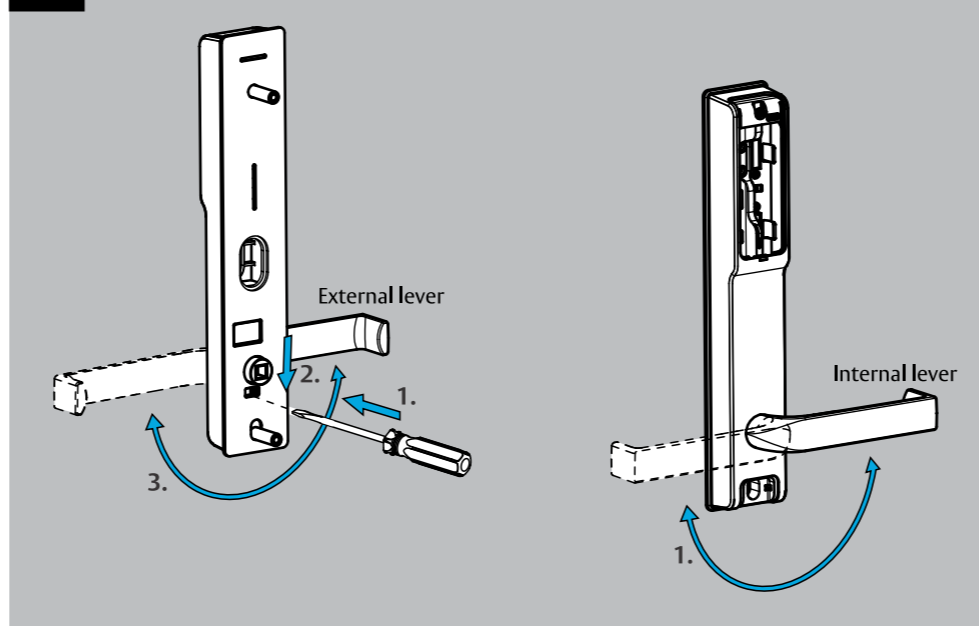

2 DOOR PREPARATION

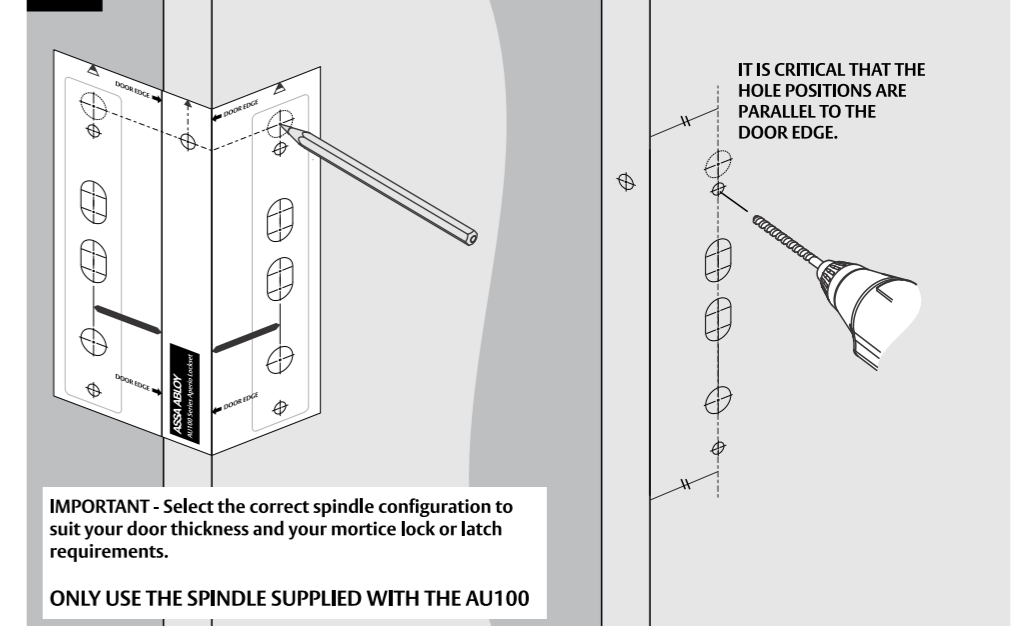

SPINDLE SELECTION

60mm Backset Mortice Lock
(NOHD variant - set to Escape both sides)

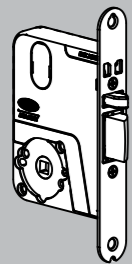

30 & 38mm Short Backset Mortice Lock
(ENOHD variant)

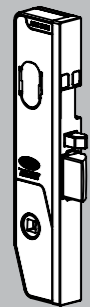

60mm Standard Latch

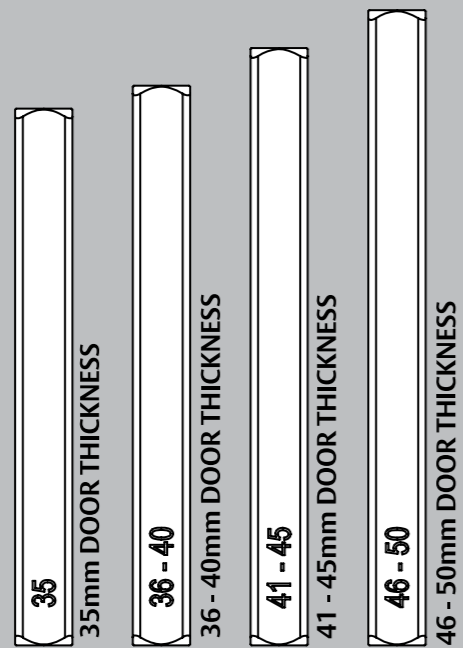
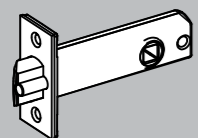

3 FITTING OF MORTICE LOCK OR LATCH

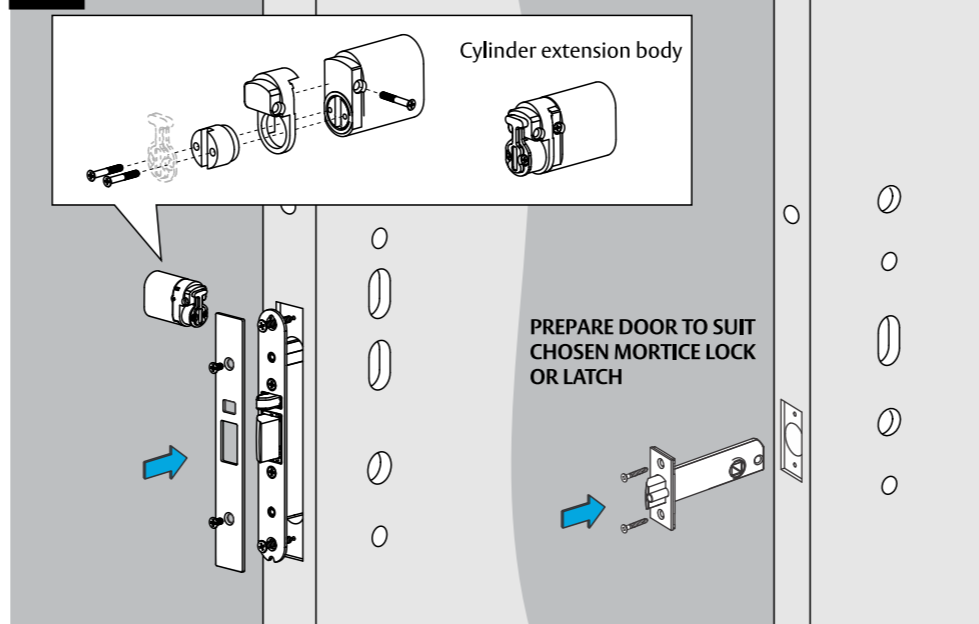

4 FITTING OF EXTERNAL SIDE

