



WINDOW TYPE AIR CONDITIONER
OWNER'S MANUAL

MODELS: GJC08BK-A6NRNE2D

Thank you for choosing our product. Please read this owner's manual carefully before operation and retain it for future reference.

TOLL-FREE: 1 866 680-4733

Operation Notices

| | |
|--------------------------|---|
| Safety Precautions | 3 |
| Precautions | 6 |
| Parts Name | 7 |

Operation Guide

| | |
|---|----|
| Function and Control | 8 |
| Introduction of remote controller | 11 |
| Instruction for fan direction adjusting | 13 |

Maintenance

| | |
|-----------------------------|----|
| Clean and Maintenance | 14 |
|-----------------------------|----|

Malfunction

| | |
|----------------------------|----|
| Malfunction analysis | 15 |
|----------------------------|----|

Installation Notice

| | |
|---|----|
| Installation and Maintenance | 18 |
| Preparation before installation | 20 |
| Window Types and Requirements | 21 |
| Installation procedure | 22 |
| Sponge Sticking Method and Procedures | 25 |

READ THIS MANUAL

Inside you will find many helpful hints on how to use and maintain your air conditioner properly. Just a little preventive care on your part can save you a great deal of time and money over the life of your air conditioner. You'll find many answers to common problems in the chart of troubleshooting tips. If you review our chart of Troubleshooting Tips first, you may not need to call for service at all.



CAUTION

Contact the authorized service technician for repair or maintenance of this unit.

Contact the installer for installation of this unit.

The air conditioner is not intended for use by young children or infirm persons without supervision.

Young children should be supervised to ensure that they do not play with the air conditioner.

If the power cord is to be replaced, replacement work must be performed by authorized personnel only.

Installation work must be performed in accordance with the national wiring standards by authorized personnel only.

SAFETY PRECAUTIONS

⚠ DANGER

Indicates a hazardous situation that, if not avoided, will result in death or serious injury.

⚠ WARNING

Indicates a hazardous situation that, if not avoided, could result in death or serious injury.

⚠ CAUTION

Indicates a hazardous situation that, if not avoided, may result in minor or moderate injury.

● Meaning of symbols used in this manual are as shown below.

| | |
|--|------------------------|
| | NEVER DO THIS. |
| | ALWAYS DO THIS. |

⚠ WARNING!

- | | | |
|---|--|--|
| <p> Plug in power plug properly</p> <p>● Otherwise, it may cause electric shock or fire due to excess heat generation.</p> | <p> Do not operate or stop the unit by inserting or pulling out the power plug.</p> <p>● It may cause electric shock or fire due to heat generation.</p> | <p> Do not damage or use an unspecified power cord.</p> <p>● If the power cord is damaged, it must be replaced by the manufacturer or an authorized service center in order to avoid hazard.</p> |
| <p> Do not modify power cord length or share the outlet with other appliances.</p> <p>● It may cause electric shock or fire due to heat generation ion.</p> | <p> Do not operate with wet hands or in damp environment.</p> <p>● It may cause electric shock.</p> | <p> Do not direct airflow at room occupants only.</p> <p>● This could damage your health.</p> |
| <p> Always ensure effective grounding</p> <p>● Incorrect grounding may cause electric shock.</p> | <p> Do not allow water to run into electric parts.</p> <p>● It may cause failure of machine or electric shock.</p> | <p> Always install circuit breaker and a dedicated power circuit.</p> <p>● Incorrect installation may cause fire and electric shock .</p> |
| <p> Unplug the unit if strange sounds, smell, or smoke comes from it.</p> <p>● It may cause fire and electric shock.</p> | <p> Do not use the socket if it is loose or damaged.</p> <p>● It may cause fire and electric shock.</p> | <p> Do not open the unit during operation.</p> <p>● It may cause electric shock.</p> |
| <p> Keep firearms away.</p> <p>● It may cause fire.</p> | <p> Do not use the power cord close to heating appliances.</p> <p>● It may cause fire and electric shock.</p> | <p> Do not use the power cord near flammable gas or combustibles, such as gasoline, benzene, thinner, etc.</p> <p>● It may cause an explosion or fire.</p> |
| <p> Ventilate room before operating air conditioner if there is a gas leakage from another appliance.</p> <p>● It may cause explosion, fire and burns.</p> | <p> Do not disassemble or modify unit.</p> <p>● It may cause failure and electric shock.</p> | |

SAFETY PRECAUTIONS

⚠ CAUTION!



When the air filter is to be removed, do not touch the metal parts of the unit.

- It may cause an injury.



Do not clean the air conditioner with water.

- Water may enter the unit and degrade the insulation. It may cause an electric shock.



Ventilate the room well when used together with a stove, etc.

- An oxygen shortage may occur.



When the unit is to be cleaned, switch off, and turn off the circuit breaker.

- Do not clean unit when power is on as it may cause fire and electric shock, it may cause an injury.



Do not put a pet or house plant where it will be exposed to direct air flow.

- This could injure the pet or plant.



Do not use for special purposes.

- Do not use this air conditioner to preserve precision devices, food, pets, plants, and art objects. It may cause deterioration of quality, etc.



Stop operation and close the window in storm or hurricane.

- Operation with windows opened may cause wetting of indoor and soaking of household furniture.



Hold the plug by the head of the power plug when taking it out.

- It may cause electric shock and damage.



Turn off the main power switch when not using the unit for a long time.

- It may cause failure of product or fire.



Do not place obstacles around air-inlets or inside of air-outlet.

- It may cause failure of appliance or accident.



Ensure that the installation bracket of the outdoor appliance is not damaged due to prolonged exposure.

- If bracket is damaged, there is concern of damage due to falling of unit.



Always insert the filters securely. Clean the filter once every two weeks.

- Operation without filters may cause failure.



Do not use strong detergent such as wax or thinner but use a soft cloth.

- Appearance may be deteriorated due to change of product color or scratching of its surface.



Do not place heavy object on the power cord and ensure that the power cord is not compressed.

- There is danger of fire or electric shock.



Do not drink water drained from air conditioner.

- It contains contaminants and could make you sick.



Use caution when unpacking and installing. Sharp edges could cause injury.



If water enters the unit, turn the unit off at the power outlet and switch off the circuit breaker. Isolate supply by taking the power plug out and contact a qualified service technician.



Do not, under any circumstances, cut, remove or bypass the grounding prong.



Power supply cord with 3-prong grounding plug and current detection device.

SAFETY PRECAUTIONS**⚠ CAUTION!**

- 1) For some models, the power supply cord with this Air Conditioner contains a current detection device designed to reduce the risk of fire. Please refer to the section "Operation of Current Device" for details. In the event that the power supply cord is damaged, it cannot be repaired. It must be replaced with a cord from the Product Manufacturer.

⚠ WARNING - FOR YOUR SAFETY

- 1) Do not store or use gasoline or other flammable vapours and liquids in the vicinity of this or any other appliance.
- 2) Avoid fire hazard or electric shock. Do not use an extension cord or an adaptor plug. Do not remove any prong from the power cord.

⚠ ELECTRICAL INFORMATION

- 1) Be sure the electrical service is adequate for the model you have chosen. This information can be found on the serial plate, which is located on the side of the cabinet and behind the grille.
- 2) Be sure the Air Conditioner is properly grounded. To minimize shock and fire hazards, proper grounding is important. The power cord is equipped with a three-prong grounding plug for protection against shock hazards.
- 3) Air Conditioner must be used in a properly grounded wall receptacle. If the wall receptacle you intend to use is not adequately grounded or protected by a time delay fuse or circuit breaker, have a qualified electrician install the proper receptacle.
- 4) Ensure the receptacle is accessible after the unit installation.
- 5) Do not run Air Conditioner without side protective cover in place. This could result in mechanical damage within the air conditioner.
DO NOT USE AN EXTENSION CORD OR AN ADAPTER PLUG.

POWER SUPPLY CORD**With current detection device only.**

The power supply cord contains a current device that senses damage to the power cord. To test your power supply cord, do the following:

- 1) Plug in the Air Conditioner.
- 2) The power supply cord will have 2 buttons on the plug head. Press the TEST button, you will notice a click as the RESET button pops out.
- 3) Press the RESET button, again you will notice a click as the button engages.
- 4) The power supply cord is now supplying electricity to the unit. On some products this is also indicated by a light on the plug head.

NOTES:

- 1) Do not use this device to turn the unit on or off.
- 2) Always make sure the RESET button is pushed in for correct operation.
- 3) The power supply must be replaced if it fails reset when either the TEST button is pushed, or it cannot be reset. A new one can be obtained from the product manufacturer.
- 4) If power supply cord is damaged, it cannot be repaired. It MUST be replaced by one obtained from the product manufacturer.

PRECAUTIONS

! WARNING!

- 1) This appliance can be used by children aged from 8 years and above and persons with reduced physical, sensory or mental capabilities or lack of experience and knowledge if they have been given supervision or instruction concerning use of the appliance in a safe way and understand the hazards involved.
- 2) Children shall not play with the appliance.
- 3) Cleaning and user maintenance shall not be made by children without supervision.
- 4) Air Conditioner should be properly grounded. Incorrect grounding may cause electric shock.
- 5) Do not connect air conditioner to multipurpose socket. Otherwise, it may cause fire hazard.
- 6) Do install the air switch. If not, it may cause malfunction.
- 7) Do not spill water on the remote controller, otherwise the remote controller may be broken.
- 8) Do not spray water on air conditioner. It may cause electric shock or malfunction.
- 9) Do not extend fingers or objects into air inlet or air outlet. It may cause personal injury or damage.
- 10) Do not step on air conditioner, or put heavy objects. It may cause damage or personal injury
- 11) Do disconnect power supply when cleaning air conditioner. Otherwise, it may cause electric shock.
- 12) Do not block air outlet or air inlet. It may cause malfunction.
- 13) Do not repair air conditioner by yourself. It may cause electric shock or damage. Please contact dealer when you need to repair air conditioner.
- 14) Maintenance must be performed by qualified professionals. Otherwise, it may cause personal injury or damage.

NOTICE:

The power cord of window type unit has creepage protection device.

There're test button and reset button on the plug.

You are suggested to check the power cord periodically.

Check method:

After putting through the power, indicator is ON. After pressing test button, indicator is OFF and you can heard a sound. Then press reset button, indicator will be ON, which indicates the protection device is normal.

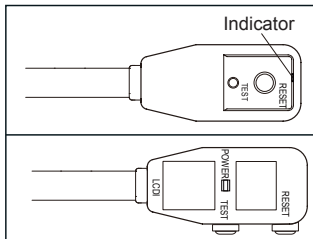

Note :

Plug may be different with the actual product.
Please refer to actual product.

WORKING TEMPERATURE RANGE

| | Indoor side DB/WB(°C/°F) | Outdoor side DB/WB(°C/°F) |
|-----------------|--------------------------|---------------------------|
| Maximum cooling | 32/23(89.6/73.4) | 43/26(109.4/78.8) |

The operating temperature range (outdoor temperature) for cooling only unit is 18°C~ 43°C(64.4. ~ 109.4°F), for heat pump unit is -7°C~ 43°C(19.4 ~ 109.4°F).

PARTS NAME

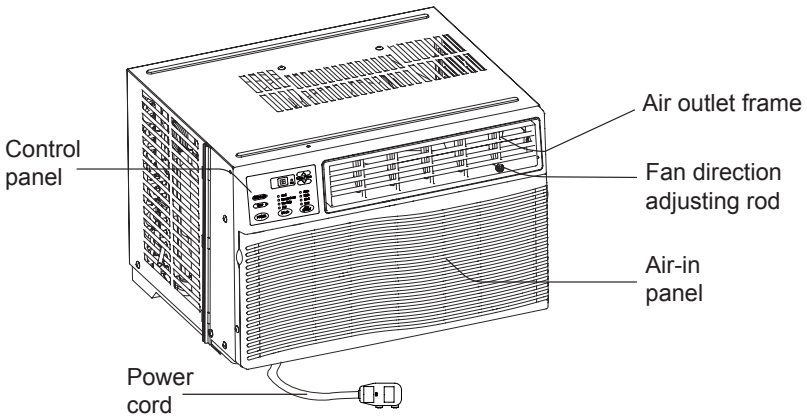



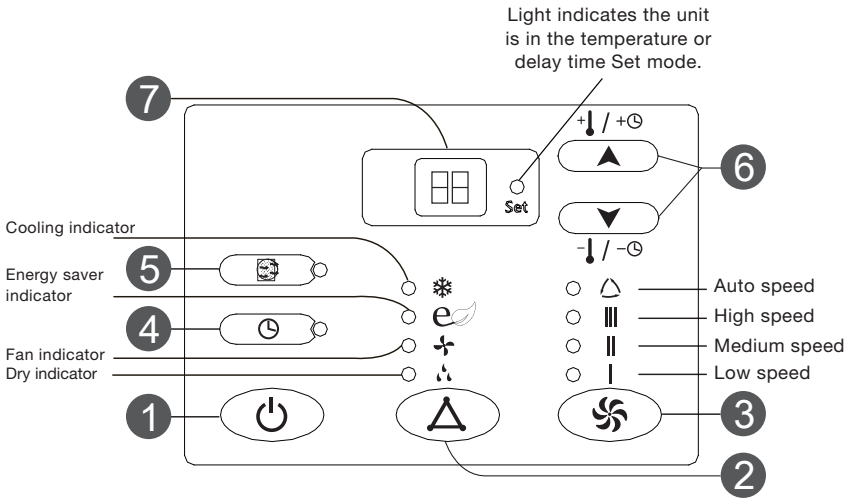

**Note:**

Panel outlook picture, just for reference, please take the real unit as standard.

Function and Control

After putting through the power, air conditioner will give out a sound and indicators on control panel will be on. After that, you operate the air conditioner through remote controller or control panel.



- 1 Power button 
- 2 Mode button 
- 3 Fan Speed button 
- 4 Timer button 
- 5 Filter check button 
- 6 Boutton 
- 7 Display

1 Power button:

Press this button can turn on or turn off air conditioner.

NOTE: Press this button to turn on air conditioner, the unit will operate in Energy Save mode; if the unit is energized after power failure, the unit will still operate according to the status before power failure.

2 Mode button:

Press this button can your required operation mode in turn.
Corresponding indicator will be on.



(AUTO):

Under this mode, the unit will operate automatically according to ex-factory setting. In this case, set temperature cannot be adjusted.

(COOL):

Under this mode, air conditioner operates under cooling mode. Cooling indicator will be on. Press "Fan Speed" button can adjust the fan speed.

(ENERGY SAVE):

Under this mode, air conditioner operates under SE mode. SE indicator will be on. Press "Fan Speed" button can adjust the fan speed.

(FAN ONLY):

Under this mode, air conditioner will not cool or heat, only blow wind. Fan indicator will be on. Press "Fan Speed" button can adjust the fan speed.
(No auto fan speed under fan mode)

(DRY):

Under this mode, the unit runs in low fan speed for dehumidification and the corresponding indicator is on; under dry mode, the fan speed cannot be adjusted.

3 Fan Speed button:

Press this button can select your required fan speed in turn.
Corresponding speed indicator will be on.



4 Timer button:

• TIMER ON:

Can be set under off state of unit. If timer ON reaches, the unit will turn on. The timer can be set in 0.5 hour increment below 10 hours and in 1 hour increment for 10 hours or above. The setting range is 0.5~24hr.

• TIMER OFF:

Can be set under on state of unit. If timer OFF reaches, the unit will turn off. The timer can be set in 0.5 hour increment below 10 hours and in 1 hour increment for 10 hours or above. The setting range is 0.5~24hr.

5 Filter check button: 

After fan rotates for 250h totally, lamp of cleaning filter is on to remind customer clean it.

Note: When user cleaned the filter, press Filter check button to clear the operation time. Meanwhile, the warning indicator will turn off.

6 Boutton ▲ / ▼:

Under temperature setting status, after each pressing of “▲” or “▼” button, temperature will increase or decrease 1°. Temperature setting range: 61~86°F (~17 to 30°C). Under timer setting status, after each pressing of “▲” or “▼” button, time will increase or decrease 0.5h or 1h.

7 Display:

- 1) Under ON status without timer setting, the operation mode is Auto, Cool, Energy Saver or Dry mode, and the set temperature will be displayed.
- 2) Under ON status without timer setting, the operation mode is fan mode and the ambient temperature will be displayed.
- 3) Time will be displayed under timer setting or timer preview.

Introduction of remote controller

Note:

This is a general use remote controller, it could be used for the air conditioners with multifunction. For some function, which the model doesn't have, if press the corresponding button on the remote controller that the unit will keep the original running status.

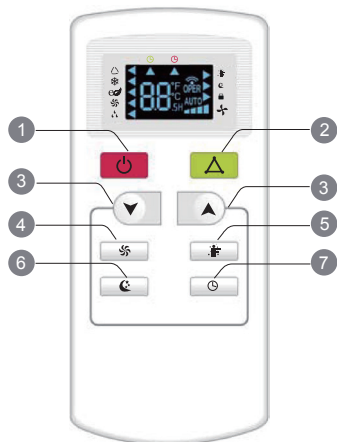

- 1 ON/OFF button (⏻)
- 2 MODE button (▲)
- 3 Button - / +
- 4 FAN button (⌘)
- 5 I FEEL button (👤)
- 6 SLEEP button (🌙)
- 7 TIMER button (🕒)

1 ON/OFF button: ⏻

Press this button to turn on the unit, turning on the unit with remote controller, the unit will operate in energy-saving mode. Press this button again to turn off the unit.

Note: If energize the unit, turn it on, turn it off and then turn it on, the unit will operate in energy-saving mode; if the unit is energized after power failure, the unit will still operate according to the status before power failure. Under off status, the complete unit doesn't respond to turning on the unit with remote controller under any mode other than energy-saving mode. In this case, the buzzer will give out two sounds for error indication. You need to turn off the unit and then turn it on with remote controller or switch to energy-saving mode after turning on the unit with remote controller.

2 MODE button: ▲

Each time you press the button, a mode is selected in a sequence that goes from AUTO, COOL, SAVE, FAN and DRY, as the following:



3 Button ▲ / ▼:

Pressing ▲ or ▼ button once will increase or decrease set temperature by 1°F(°C). Hold ▲ or ▼ button for 2s, set temperature on remote controller will change quickly. Release the button after your required set temperature is reached.

Under timer setting status, after each pressing of ▲ or ▼ button, time will increase or decrease by 0.5h. Hold ▲ or ▼ button, 2s later, time displayed on dual-8 nixie tube will change quickly. Loosen the button until the time is reached to your set time.

4 FAN button:

Use this button to adjust the fan speed in the following order:



NOTE:

There are 3 speeds for the Fan Speed of this model.

5 I FEEL button:

I feel function will be action if pressing this button. If controller receives I FEEL order, it will work under ambient temperature value which sending by remote controller, and remote controller will send ambient temperature value to controller every 10min. After 11min, if controller does not receive ambient temperature value which sending by remote controller, it will run with AC ambient temperature; if I FEEL is not set, ambient temperature will adopt sampling value of AC temperature sensor. If power off happens, this function will not be memorized.

6 SLEEP button:

Press this button to go into the SLEEP operation mode. Press it again to cancel this function. This function is available in COOL, SAVE, HEAT (Only for models with heating function) or DRY mode to maintain the most comfortable temperature for you.

7 TIMER button:

Press this button to initiate auto-on/auto-off timer. To cancel auto-timer program, press this button twice.

FUNCTION INTRODUCTION FOR COMBINATION BUTTONS

Light function:

Under switch-on or switch-off state, you may hold “▲” and “⚡” buttons simultaneously for 3 seconds to set the lamp on or off and send the code. After being energized the lamp is defaulted on.

Child lock function:

Press “▲” and “▼” buttons simultaneously can turn on or turn off child lock function. When child lock function is started up, LOCK indicator on remote controller is ON. If you operate the remote controller, remote controller won't send signal.

Temperature display switch over function:

Under OFF status, press “▼” button and “△” button simultaneously can switch between °C and °F.

REPLACEMENT OF BATTERIES IN REMOTE CONTROLLER

- 1) Press the mark “” on back cover of batteries box cover for remote controller with fingers as shown in the fig, and then remove the batteries box cover along the arrow direction.
- 2) Replace with two (AAA 1.5V) dry batteries. Make sure positions for “+” pole and “-” pole are correct.
- 3) Reinstall batteries box cover.

NOTICE:

- The distance between signal sender and receiving window should be no more than 8m, and there should be no obstacles between them
- As the signal will be interfered in the room with electronic fluorescent lamp, conversion fluorescent lamp or wireless phone, please get closer to the air conditioner when using the remote controller.
- Replace new batteries of the same model when replacement is required.
- When you don't use remote controller for a long time, please take out the batteries.

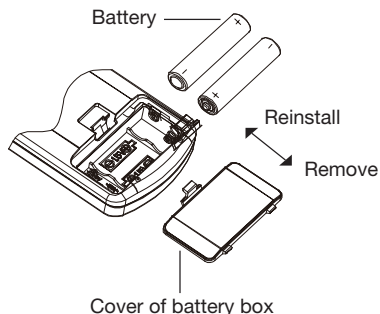
**Instruction for fan direction adjusting**

You can adjust the fan direction adjusting rod to select left & right air outlet direction according to your requirement.

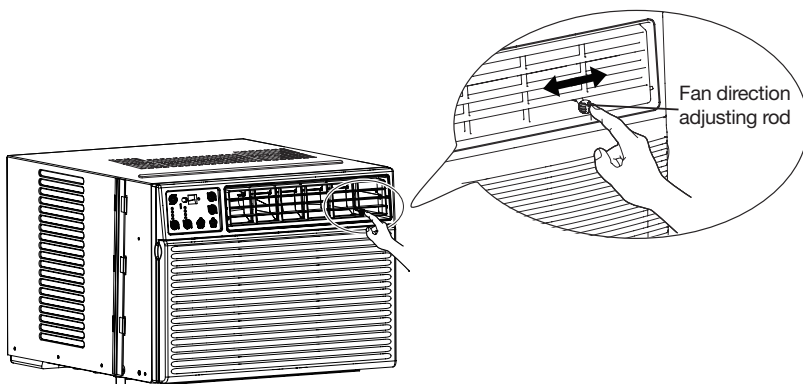

You can adjust the air outlet frame to select up & down air outlet direction according to your requirement.

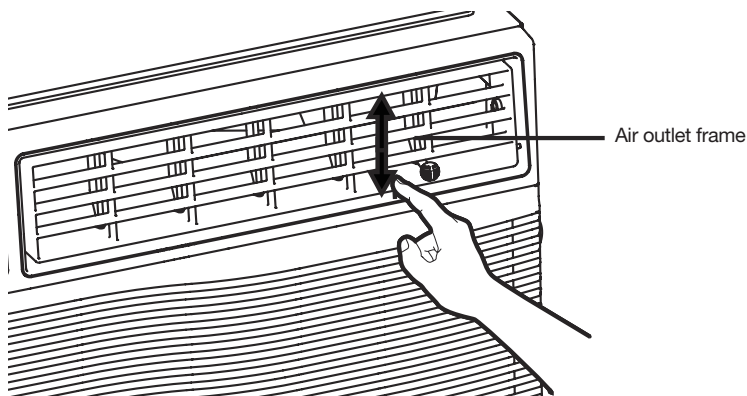

Clean and Maintenance

WARNING!

- 1) Turn off the air conditioner and disconnect the power before cleaning the air conditioner to avoid electric shock.
- 2) Do not wash the air conditioner with water to avoid electric shock.
- 3) Do not use volatile liquid to clean the air conditioner.

CLEAN FILTER

- 1) Open the panel. Pull the groove at both sides of panel forcibly to open the panel to a certain angles as shown in the illustration.
- 2) Remove the filter as show in the illustration.
- 3) Clean the filter
 - Use dust catcher or water to clean the filter.
 - If the filter is very dirty, you can use warm water dissolved with neutral abluent, and then put it under the shady place.
- 4) Install the filter and then buckle the panel cover tightly.

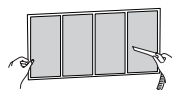
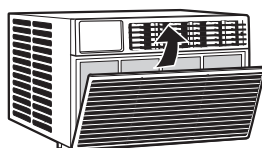
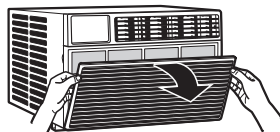

NOTICE:

- Clean the filter about once every three month. If there are lots of dust in operation environment, you can increase the clean times.
- Due to there's shaft metal fins in the air conditioner, do no touch the fins after removing filter to avoid scratching.
- Do not dry the filter on fire or use hair drier to dry the filter. Otherwise, the filter may be deformed or catch fire.
- Do not operate the air conditioner when the filter hasn't been installed.

CLEAN THE PANEL

If the surface of panel is very dirty, you are suggested to use soft dry cloth or wet cloth dipped with neutral abluent to wipe it.

Note:

Do not remove the panel when cleaning it.

MAINTAIN THE OUTER CASE

You are suggested to check the outer case of air conditioner one or twice every year. If the outer case is damaged or rusted, please contact dealer.

Note:

In order to reduce damage or rust under no-use season, you can cover the air conditioner with protective covering.

Malfunction analysis

GENERAL PHENOMENON ANALYSIS

Please check below items before asking for maintenance. If the problem still can't be solved, please contact dealer or professional person.

| Phenomenon | Troubleshooting | Solution |
|---|---|---|
| Air conditioner can't operate | Power failure? | Wait after power recovery. |
| | Is plug loose? | Reinsert the plug. |
| | Whether the air switch is tripped off or fuse is burnt? | Ask professional person to replace air switch or fuse. |
| | Is there's malfunction for the circuit? | Ask professional person to replace circuit. |
| | Whether the unit is restarted up after stopping immediately? | Wait after voltage is resumed. |
| | The protection device for the plug of power cord trips off? | Please press reset button on plug again. If the power trips off again and heard a sound, there's malfunction for the plug or the unit. Please contact after-sales maintenance person. |
| Poor cooling (heating) | Is the power too low? | Wait after voltage is resumed. |
| | Whether the air filter is too dirty? | Clean the air filter. |
| | Whether the set temperature is proper? | Adjust the temperature. |
| | Whether door and window are closed? | Close door and window. |
| Air conditioner can't receive signal from remote controller or remote controller is not sensible. | Whether the unit is interfered seriously (such as static pressure, unstable voltage)? | Please pull out the plug. Insert the plug after about 3min, and then turn on the unit. |
| | Whether remote controller is within the receiving range? | The receiving range of remote controller is 8m. Do not exceed this range. |
| | Whether it's blocked by obstacles? | Remove the obstacles. |
| | Is sensitivity of remote controller low? | Check the batteries of remote controller. If the power is low, please replace the batteries. |
| | Whether there's fluorescence lamp in the room? | Move the remote controller close to air conditioner. |

| Phenomenon | Troubleshooting | Solution |
|---|---|--|
| No fan blowed out from air conditioner | Whether air outlet or air inlet is blocked? | Eliminate the obstacles. |
| | Under heating mode, whether indoor temperature is reached to set temperature? | The unit will stop blowing fan after reaching to set temperature. |
| | Whether heating mode is started up just now? | In order to prevent cold air, air conditioner will delay for a while to be started up, which is the normal phenomenon. |
| Set temperature can't be adjusted | Whether the unit operates under auto mode? | Temperature can't be adjusted under auto mode. |
| | Whether the required temperature exceeds the temperature setting range? | Temperature setting range: 61°F (17°C) ~86°F (30°C). |
| The device gives off an odor | There's off-flavour source in the room, such as furniture, cigarette, etc. | Remove the source of the smell |
| | | Clean the filter |
| There's abnormal sound during operation | Whether the unit is interfered by thunder, radio, etc? | Disconnect power, put through the power again, and then turn on the unit again. |
| You can heard water-flowing sound | Whether the unit is turned on or turned off just now? | There's flowing sound of refrigerant inside the air conditioner, which is the normal phenomenon. |
| The device makes a knock sound | Whether the unit is turned on or turned off just now? | Heat expansion or shrinkage for the panel due to change of temperature, which cause friction sound. |

Malfunction code

When there's abnormal phenomenon for the air conditioner, dual-8 nixie tube displays corresponding malfunction code:

| Malfunction code | Solution |
|------------------|---|
| F1 | Please contact professional person to deal with it. |
| F2 | Please contact professional person to deal with it. |
| F4 | Please contact professional person to deal with it. |
| FJ | Please contact professional person to deal with it. |
| EP | Please contact professional person to deal with it. |
| F0 | Please contact professional person to deal with it. |
| H3 | Please contact professional person to deal with it. |

Note:

EP malfunction code is only applicable for cooling only unit.

F1/F2/F4/FJ malfunction codes are only applicable for electric heating model.

 **WARNING!**

- | | |
|----|--|
| 1) | If there's below phenomenon, please turn off the air conditioner and disconnect the power immediately. After that, please contact dealer at once. <ul style="list-style-type: none">• Power cord is overheating or damaged.• There's abnormal sound during operation.• There's burning smell.• Power cord test or reset button often bounces automatically.• Water leakage at indoor side. |
| 2) | Do not repair or refit the air conditioner by yourself. |
| 3) | Operate the air conditioner under abnormal status will cause malfunction, electric shock or fire hazard. |

Installation and Maintenance



WARNING!

- | |
|--|
| 1) Observe all governing codes and ordinances. |
| 2) Do not use damaged or non-standard power cord. |
| 3) Be caution during installation and maintenance. Prohibit incorrect operation to prevent electric shock, casualty and other accidents. |

SELECTION OF INSTALLATION LOCATION

Basic requirement

Installing the unit in the following places may cause malfunction. If it is unavoidable, please consult the local dealer:

- 1) The place with strong heat sources, vapors, flammable or explosive gas, or volatile objects spread in the air.
- 2) The place with high-frequency devices (such as welding machine, medical equipment).
- 3) The place near coast area.
- 4) The place with oil or fumes in the air.
- 5) The place with sulfureted gas.
- 6) Other places with special circumstances.

Requirement of complete unit











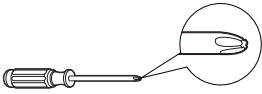

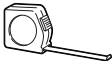
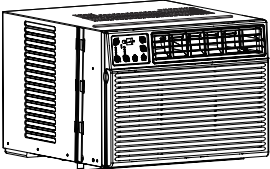
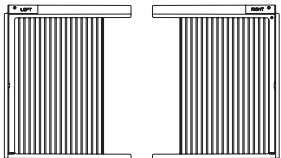

- 1) There should be no obstruction near air inlet and air outlet.
- 2) Select a location where the condensation water can be dispersed easily and won't affect other people.
- 3) The location should be able to withstand the weight of the unit and won't increase noise and vibration.
- 4) Select a location where the noise and outflow air emitted by the unit will not affect neighbourhood.
- 5) The location should be able to withstand the weight of unit.
- 6) Select a location which is out of reach for children and far away from animals or plants. If it is unavoidable, please add fence for safety purpose.
- 7) Please try your best to keep far away from fluorescent lamp.

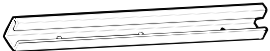
REQUIREMENTS FOR ELECTRIC CONNECTION

Safety precaution

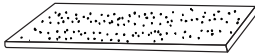
- 1) Must follow the electric safety regulations when installing the unit.
- 2) According to the local safety regulations, use qualified power supply circuit and air switch.
- 3) Make sure the power supply matches with the requirement of air conditioner. Unstable power supply or incorrect wiring may result in electric shock, fire hazard or malfunction.
- 4) Please make sure the power supply complies with the requirement of air conditioner. Unstable power supply or wrong wiring may lead to electric shock, fire hazard or malfunction.
- 5) Properly connect the live wire, neutral wire and grounding wire of power socket.
- 6) Do not put through the power before finishing installation.
- 7) Be sure to cut off the power supply before proceeding any work related to electricity and safety.
- 8) The air conditioner is first class electric appliance. It must be properly grounding with specialized grounding device by a professional. Please make sure it is always grounded effectively, otherwise it may cause electric shock.
- 9) The yellow-green wire or green wire in air conditioner is grounding wire, which can't be used for other purposes.
- 10) The grounding resistance should comply with national electric safety regulations.

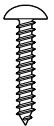
Preparation before installation

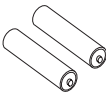
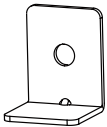
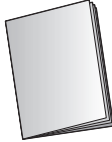
| | | | | |
|------------------------|---|---|---|---|
| Tools for installation |  | |  | |
| | Phillips screwdriver | | Flat-blade screwdriver | |
| |  |  |  |  |
| | Level | Scissors | Pencil | Measuring tape |
| Spare parts list |  | |  | |
| | Air conditioner | | Left and right accordion panel | |
| |  | |  | |
| | Sealing strip (with adhesive)(2) | | Top mounting rail | |
| |  | |  | |
| | Sealing strip (without adhesive) | | Top mounting rail seal strip | |
| |  |  |  |  |
| | Accordion panel seal (2) | Foam Insulation (2) | Screw A (4) | Screw B (6) |
| |  |  |  |  |
| | Remote controller | Batteries | Window locking bracket (1) | User Manual |

Window types and requirements

Note:

- The description for below installation is for the standard window. If it's other types of window, you may need to adjust the window.
- If you install the device in a small window, you may not need the flexible display. Please refer to the window dimensions for details.
- All parts used for supporting air conditioner should be fixed at solid wooden strap, brick or metal.
- Socket must be installed at the position where the power cord is available.

STANDARD WINDOW

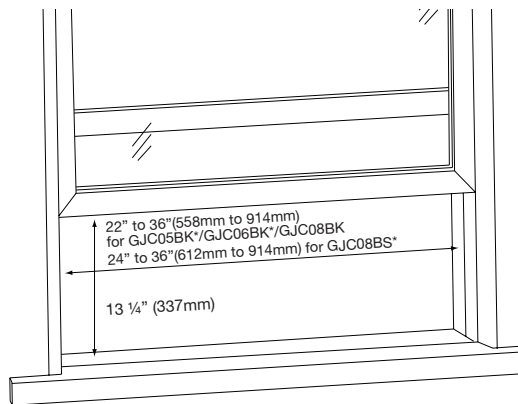

WEATHER-PROOF TYPE WINDOW

The height of window frame is higher than windowsill for some weather-proof type window, which will affect the installation of air conditioner. In this case, before installing the air conditioner, add wooden strap on the windowsill and fix the wooden strap at the windowsill.

Specification of wooden strap

Width: about 2"

Length: same to the inner frame size of window

Height: Put the wooden strap on the windowsill, top part of wooden strap and window frame should be at the same horizontal level, or higher than the top part of window frame about 1/4"-1/2".

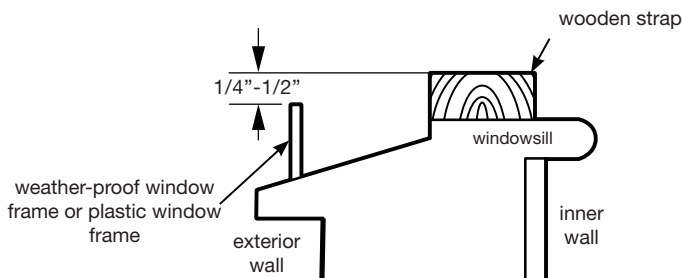

Installation procedure

Step 1: Install top mounting rail

- 1) Tear off the paster at back side of top mounting rail seal strip, and then align it at the bottom edge of top mounting rail to stick the top mounting rail seal strip at the bottom of top mounting rail. (The top mounting rail seal strip has been stick on the top mounting rail for some models. Therefore, this step can be omitted.)

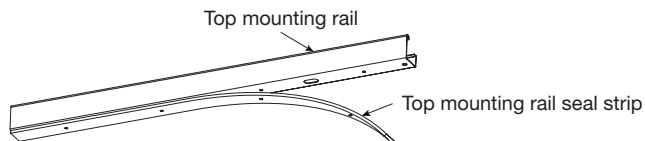

- 2) Use 4 type A screws to fix the top mounting rail at the outer case of air condition. (The top mounting rail has been fixed on the conditioner for some models. Therefore, this step can be omitted.)

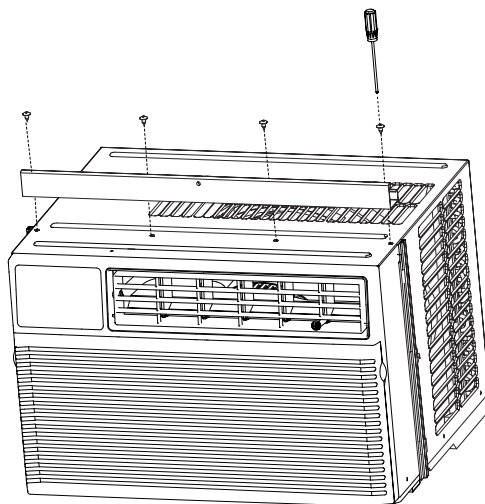

Step 2: Install accordion panel

- 1) Stick one accordion panel seal respectively on the left side and right side of accordion panel installation frame, as shown in the figure.

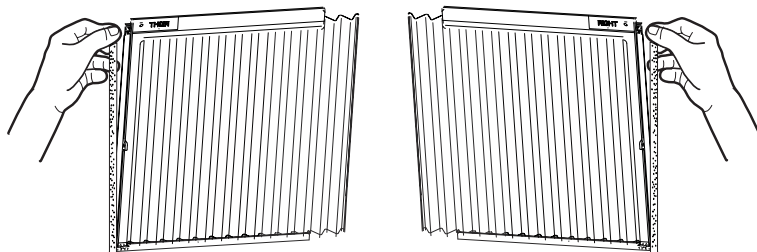

- Undraw the accordion panel, install the accordion panel marked with "LEFT" "RIGHT" at both sides of air conditioner in turn. Slide the upper and lower ends of accordion panel into top mounting rail and lower guide rails.

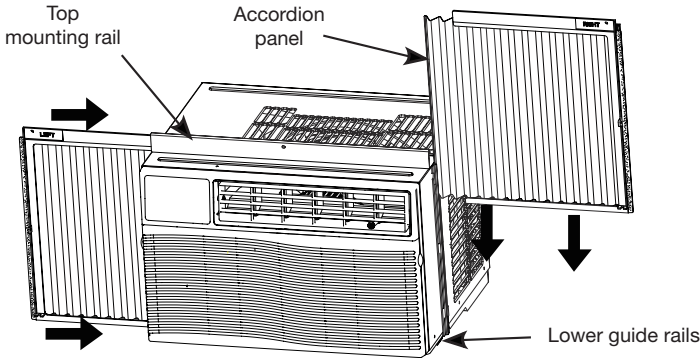

Step 3: Stick window sill and sash seal

- Cut the window sill and sash seal into proper length. Tear off the paster and then stick the seal at the lower part of the window frame.

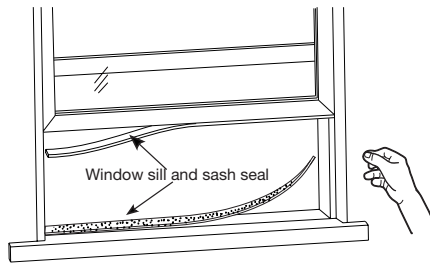

Step 4: Put the air conditioner

- Ask 2 persons to put the air conditioner at the windowsill, and the lower guide rail should be stick at the windowsill. Top mounting rail stays at the middle lower side of window and then window can stick to the top mounting rail when closing it. Please note that the air conditioner should be placed at horizontal place or inclined outwards slightly.

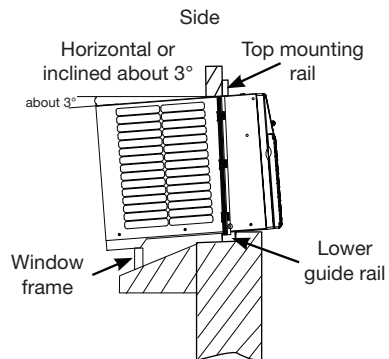
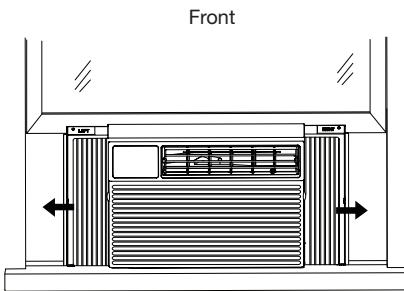

- Pull the window, undraw accordion panels at both sides to keep it vertical to the window frame and then use 5 type B screws and frame locking bracket to fix the frame of accordion panel at window frame and windowsill.

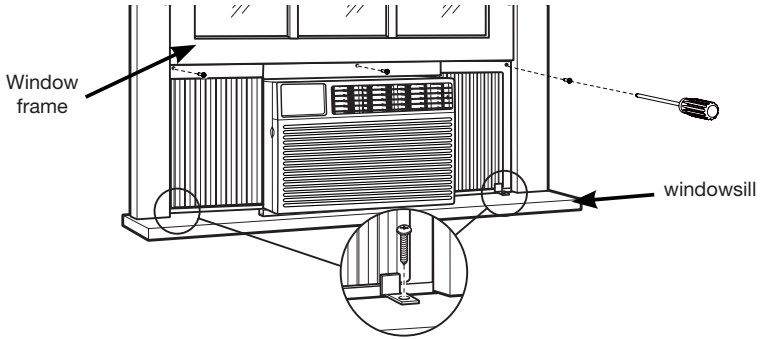

Step 5: Install window locking bracket

- 1) Install the window locking bracket at the window frame to fix the window.

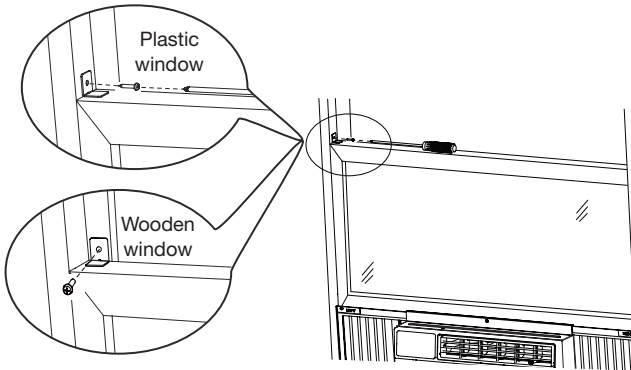

Step 6: Plug foam top window gasket

- 1) Cut the foam top window gasket into the length same to the width of window. Plug the foam between glasses and window to prevent rain and insects getting into the room.

Note:

If foam top window gasket is not proper to your window, you can select other proper materials to replace it.

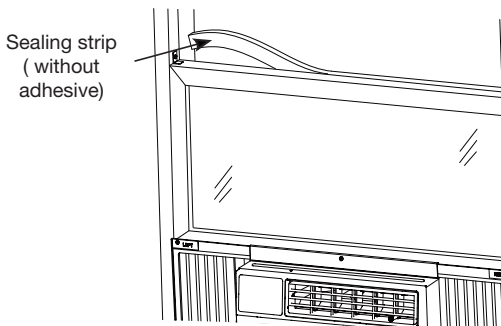

Sponge Sticking Method and Procedures

- 1) Install accordion panel sub-assy. After finishing installation, measure the width L between outer case of air conditioner and window frame.

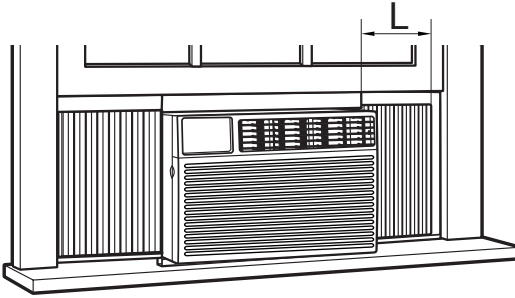

- 2) Take out foam insulation from the package. Cut off the foam insulation in rectangular shape with scissors.

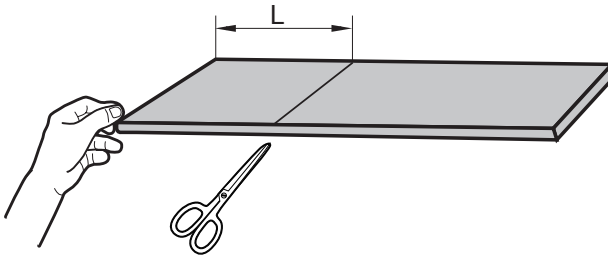

- 3) Stick foam insulation evenly on the accordion panel and the screen of window frame. The redundant 2~3mm of foam insulation in height can be stuffed into the frame for fixing.

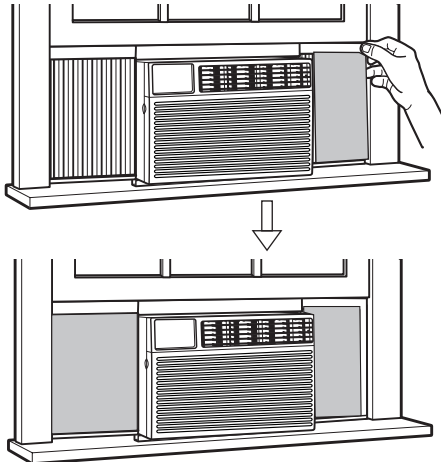

WARRANTY

LIMITED WARRANTY

This Air Conditioner is covered by a warranty against defects in materials including the compressor, if used for the applications specified in this owner's manual, for a period of one (1) YEAR from the date of original purchase in Canada.

Note: The internal compressor is covered by a 5-year limited warranty.

During the warranty period, if this Air Conditioner fails under normal use, GREE will, at its option, either repair the unit or replace it, free of charge, within a reasonable period of time after the Air Conditioner is returned. As a condition to any warranty service obligation, the customer must present this warranty certificate along with the proof of purchase.

THIS WARRANTY DOES NOT COVER:

- 1) Damage, accidental or otherwise, to the air conditioner that is not caused by materials or workmanship defect.
- 2) Damage caused by misuse, tampering or failure to follow the operating and maintenance instructions provided in this owner's manual.
- 3) Damage to the finish of the unit enclosure or to other outer features caused by wear.
- 4) Filter.
- 5) Damage caused by repairs or modifications to the air conditioner made by any person not duly authorized by GREE.
- 6) Insurance and freight costs for the warranty service.

ALL IMPLIED WARRANTIES, INCLUDING ANY IMPLIED WARRANTY OF MERCHANTABILITY, ARE LIMITED TO A ONE (1) YEAR PERIOD COVERED BY THIS EXPRESS LIMITED WARRANTY. GREE DISCLAIMS ANY LIABILITY FOR CONSEQUENTIAL OR INCIDENTAL DAMAGES AND, IN NO EVENT, SHALL GREE LIABILITY EXCEED THE RETAIL VALUE OF THIS AIR CONDITIONER FOR BREACH OF ANY WRITTEN OR IMPLIED WARRANTY WITH RESPECT TO THIS AIR CONDITIONER.

Keep this owner's manual along with your proof of purchase in a safe place for future reference. You must provide proof of purchase for warranty service.

Enter the following information on your air conditioner; it will help you upon getting assistance or service if you ever need it. You will have then to provide the model and serial numbers of the air conditioner - these data are detailed on the rating plate of the unit.

Dealer name: _____

Address: _____

Model number: _____

Serial number: _____

Date of purchase: _____