



## OWNER'S MANUAL



GWC09QB-D3DNA6E  
GWH09QB-D3DNA6E  
GWC12QC-D3DNA6E  
GWH12QC-D3DNA6E  
GWC18QD-D3DNA6E  
GWH18QD-D3DNA6E  
GWC24QE-D3DNA6E  
GWH24QE-D3DNA6E

Thank you for choosing our product. Please read this owner's manual carefully before operating the unit and keep it for future reference.

GWC09QB-D3DNA6E  
GWH09QB-D3DNA6E  
GWC12QC-D3DNA6E  
GWH12QC-D3DNA6E  
GWC18QD-D3DNA6E  
GWH18QD-D3DNA6E  
GWC24QE-D3DNA6E  
GWH24QE-D3DNA6E

## Content

### Operation Notices

|                                  |   |
|----------------------------------|---|
| Precautions .....                | 1 |
| Parts Name .....                 | 5 |
| Indoor Unit Screen Display ..... | 6 |

### Remote Control

|   |    |
|---|----|
| Buttons on remote control .....                     | 7  |
| Introduction for icons on remote control .....      | 8  |
| Operation of remote control .....                   | 9  |
| Special functions .....                             | 12 |
| Replacement of batteries in remote controller ..... | 13 |
| Emergency operation .....                           | 14 |

### Maintenance

|                             |    |
|-----------------------------|----|
| Clean and Maintenance ..... | 15 |
|-----------------------------|----|

### Malfunction

|                            |    |
|----------------------------|----|
| Malfunction analysis ..... | 17 |
|----------------------------|----|

### Installation Notice

|  |    |
|--|----|
| Installation dimension diagram .....       | 21 |
| Tools for installation .....               | 22 |
| Selection of installation location .....   | 22 |
| Requirements for electric connection ..... | 23 |

### Installation

|                                    |    |
|------------------------------------|----|
| Installation of indoor unit .....  | 24 |
| Installation of outdoor unit ..... | 29 |
| Vacuum pumping .....               | 32 |
| Leakage detection .....            | 32 |
| Check after installation .....     | 33 |

### Test and operation

|                      |    |
|----------------------|----|
| Test operation ..... | 33 |
|----------------------|----|

### Attachment

|  |    |
|--|----|
| Configuration of connection pipe ..... | 34 |
| Pipe expanding method .....            | 36 |
| Wired Controller .....                 | 37 |

This appliance is not intended for use by persons (including children) with reduced physical, sensory or mental capabilities, or lack of experience and knowledge, unless they have been given supervision or instruction concerning use of the appliance by a person responsible for their safety. Children should be supervised to ensure that they do not play with the appliance.



**DANGER**

Indicates a hazardous situation that, if not avoided, will result in death or serious injury.



**WARNING**

Indicates a hazardous situation that, if not avoided, could result in death or serious injury.



**CAUTION**

Indicates a hazardous situation that, if not avoided, may result in minor or moderate injury.

**NOTICE**

Indicates important but not hazard-related information, used to indicate risk of property damage.



Indicates a hazard and it is assigned to the signal words DANGER, WARNING or CAUTION.

**Precautions****WARNING****Operation and Maintenance**

- This appliance can be used by children aged from 8 years and above and persons with reduced physical, sensory or mental capabilities or lack of experience and knowledge if they have been given supervision or instruction concerning use of the appliance in a safe way and understand the hazards involved.
- Children shall not play with the appliance.
- Cleaning and user maintenance shall not be made by children.
- Do not connect air conditioner to multi-purpose socket. Otherwise, it may cause fire hazard.
- Do disconnect power supply when cleaning air conditioner. Otherwise, it may cause electric shock.
- If the supply wire is damaged, it must be replaced by the manufacturer, its service agent or similarly qualified persons in order to avoid a hazard.
- Do not wash the air conditioner with water to avoid electric shock.
- Do not spray water on indoor unit. It may cause electric shock or malfunction.
- After removing the filter, do not touch fins to avoid injury.
- Do not use fire or hair dryer to dry the filter to avoid deformation or fire hazard.

**Precautions****Operation and Maintenance**

- Maintenance must be performed by qualified professionals. Otherwise, it may cause personal injury or damage.
- Do not repair air conditioner by yourself. It may cause electric shock or damage. Please contact dealer when you need to repair air conditioner.
- Do not extend fingers or objects into air inlet or air outlet. It may cause personal injury or damage.
- Do not block air outlet or air inlet. It may cause malfunction.
- Do not spill water on the remote control, otherwise the remote control may be broken.
- When below phenomenon occurs, please turn off air conditioner and disconnect power immediately, and then contact the dealer or qualified professionals for service.
  - There's abnormal sound during operation.
  - Circuit break trips off frequently.
  - Air conditioner gives off burning smell.
  - Indoor unit is leaking.
- If the air conditioner operates under abnormal conditions, it may cause malfunction, electric shock or fire hazard.
- When turning on or turning off the unit by emergency operation switch, please press this switch with an insulating object other than metal.
- Do not step on top panel of outdoor unit, or put heavy objects. It may cause damage or personal injury.

## Precautions



# WARNING

## Attachment

- Installation must be performed by qualified professionals. Otherwise, it may cause personal injury or damage.
- Must follow the electric safety regulations when installing the unit.
- According to the local safety regulations, use qualified power supply circuit and circuit break.
- Install a circuit breaker of adequate capacity only used for the system; otherwise, it may cause malfunction.
- An all-pole disconnection switch having a contact separation of at least 3mm in all poles should be connected in fixed wiring.
- Air Conditioner should be properly grounded. Incorrect grounding may cause electric shock.
- Make sure the power supply matches with the requirement of air conditioner. Unstable power supply or incorrect wiring may cause malfunction of the unit, electric shock or fire hazard
- Properly connect the live wire, neutral wire and grounding wire.
- Be sure to cut off the power supply before proceeding any work related to electricity and safety.

## Precautions



# WARNING

- Do not put through the power before finishing installation.
- If the supply cord is damaged, it must be replaced by the manufacturer, its service agent or similarly qualified persons in order to avoid a hazard.
- The temperature of refrigerant circuit will be high, please keep the interconnection cable away from the copper tube.
- The appliance shall be installed in accordance with national wiring regulations.
- Installation must be performed in accordance with the requirement of NEC and CEC by authorized personnel only.
- The air conditioner is a first class electric appliance. It must be properly grounded with specialized grounding device by a professional. Please make sure it is always grounded effectively, otherwise it may cause electric shock.
- The yellow-green wire in the air conditioner is the grounding wire, which can't be used for other purposes.
- The grounding resistance should comply with national electric safety regulations.
- All wires of indoor unit and outdoor unit should be connected by a professional.
- If the length of power connection wire is insufficient, please contact the supplier for a new one. Do not extend the wire yourself.



## Precautions

**WARNING**

- If you need to relocate the air conditioner to another place, only a qualified person can perform the work. Otherwise, it may cause personal injury or damage.
- Select a location which is out of reach for children and far away from animals or plants. If it is unavoidable, please add the fence around the outdoor unit for safety purpose.
- The indoor unit should be installed close to the wall.
- Instructions for installation and use of this product are provided by the manufacturer.

**Working temperature range**

|                 | Indoor side DB/WB(°C ) | Outdoor side DB/WB(°C ) |
|-----------------|------------------------|-------------------------|
| Maximum cooling | 26.7/19.4 (80/66.9)    | 46.1/23.9 (115/75)      |
| Maximum cooling | 26.7/- (80/-)          | 23.9/18.3 (75/64.9)     |

**NOTICE :**

- The operating temperature range (outdoor temperature) for cooling only unit is -18 (-0.4°F)~46.1°C (115°F) ; for heat pump unit is -20°C (-4°F)~46.1°C (115°F).

## Parts Name

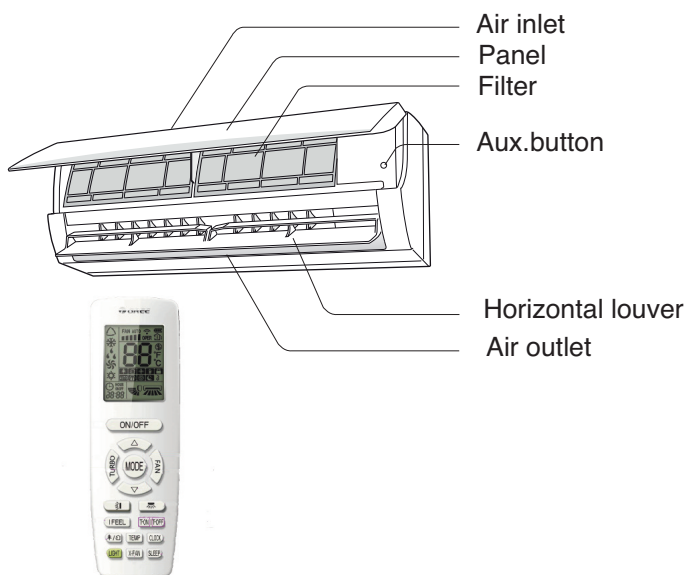
**Indoor Unit****AVIS :**

(Display content or position may be different from above graphics, please refer to actual products)

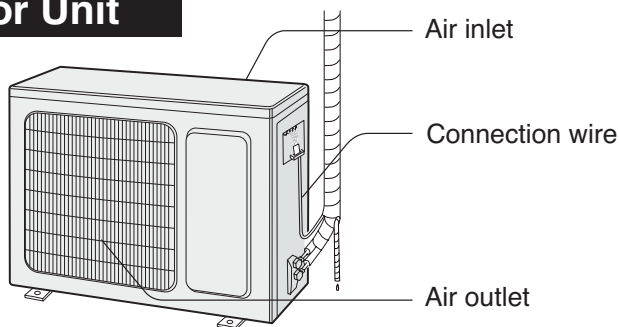
**Outdoor Unit****NOTICE :**

Actual product may be different from above graphics, please refer to actual products.

# Indoor Unit Screen Display

Display and icons position may vary with models

For some model:

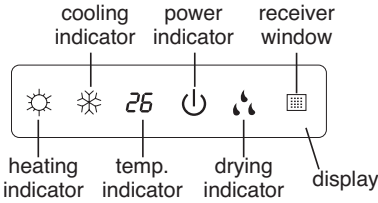

For some model:

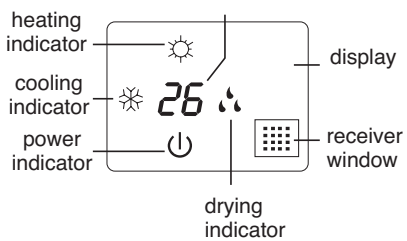

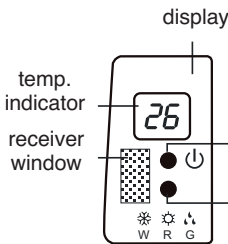

For some model:



Power LED color indicator:  
Green status ON:  
Red status OFF:

Mode LED color indicator:

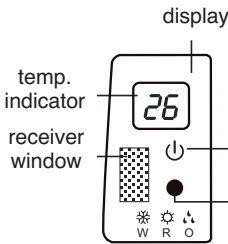

White W Cool Mode   
Red R Heat Mode  (only for heating mode)  
Green G Dry Mode 

For some model:



Power LED color indicator:  
Green-status-ON.  
Red -status-OFF.

Mode LED color indicator:

White W Cool Mode   
Red R Heat Mode  (only for heating mode)  
Orange O Dry Mode 



Display content or position may be different from above graphics, please refer to actual products.

**Remote Control:**

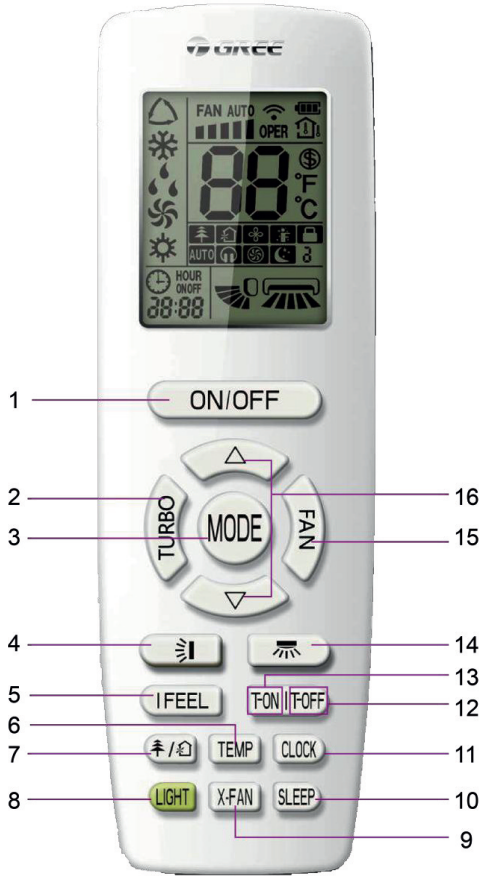
**Button name and function introduction**



## Using the Remote Control

| No. | Button name   | Function   |
|-----|---|--|
| 1   | ON/OFF  | Turn on or turn off the unit                             |
| 2   | TURBO   | Set turbo function                                       |
| 3   | MODE  | Set operation mode                                       |
| 4   |  | Set up&down swing status                                 |
| 5   | I FEEL  | Set I FEEL function                                      |
| 6   | TEMP  | Switch temperature displaying type on the unit's display |
| 7   |  | Set health function and air function                     |
| 8   | LIGHT   | Set light function                                       |
| 9   | X-FAN   | Set X-FAN function                                       |
| 10  | SLEEP   | Set sleep function                                       |
| 11  | CLOCK   | Set clock of the system                                  |
| 12  | TOFF  | Set timer off function                                   |
| 13  | TON   | Set timer on function                                    |
| 14  |  | Set left&right swing status                              |
| 15  | FAN   | Set fan speed  |
| 16  | △▽  | Set temperature and time                                 |

### 1.2 Preparation before operation

When using the remote control for the first time or after replacing the batteries, please set the current time as per the following steps:

- (1). Pressing CLOCK button,  is blinking.
- (2). Pressing △ or ▽ button, the clock time will increase or decrease rapidly.
- (3). Press CLOCK button again to confirm the time and return to display current time.

### Using the Remote Control

- (1). Selecting operation mode  
In unit on status, press MODE button to select operation mode in following sequence:

## Using the Remote Control

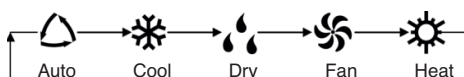

### (2). Setting temperature

In unit on status, press button to increase setting temperature and press button to decrease setting temperature. The range of temperature is from 16°C to 30°C.

**Note:** Under auto mode, you cannot change the temperature.

### (3). Adjusting fan speed

In unit on status, press FAN button to adjust fan speed in following sequence:

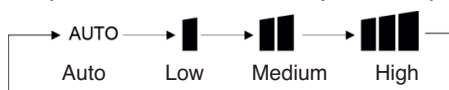

**Note:**

- ①. When operation mode changes, fan speed is memorized;
- ②. Under dry mode, fan speed is low and can not be adjusted.

### (4). Setting swing function

#### ◆ Setting left&right swing

- 1). Under simple swing status, press button to adjust left&right swing status;
- 2). Under fixed-angle swing status, press button to adjust left&right swing angle circularly as below:

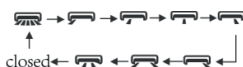

**Note:** operate continuously left&right swing in 2 seconds, swing status will change according to above-mentioned order, or switch closed status and status.

#### ◆ Setting up&down swing

- 1). Under simple swing status, press button to adjust up&down swing status;
- 2). Under fixed-angle swing status, press button to adjust up&down swing angle circularly as below:



**Note:** operate continuously left&right swing in 2 seconds, swing status will change according to above-mentioned order, or switch closed status and status;

## Using the Remote Control

### (5). Setting turbo function

Under cool or heat mode, press TURBO button to set turbo function. When  is displayed, turbo function is on. When it is not displayed, turbo function is off.

When turbo function is on, the unit operates in super high speed to achieve quick cooling or heating. When turbo function is off, the unit operates in setting fan speed.

### (6). Setting light function

The light on the receiver light board will display present operation status. If you want to turn off the light, please press LIGHT button. Press this button again to turn on the light.

### (7). Viewing ambient temperature

In unit on status, receiver light board is defaulted to display setting temperature. Press TEMP button to view indoor or outdoor ambient temperature.

When  is displayed, the set in temperature is displayed.

When  is displayed, the indoor ambient temperature is displayed.

When  is displayed, the current outdoor temperature is displayed.

**Note:** set in temperature is always displayed in Remote Controller.

### (8). Setting X-FAN function

In cool or dry mode, press X-FAN button to set X-FAN function. When  is displayed, X-FAN function is on. When you cancel the function by pressing again the button, the icon will disappear. When X-FAN function is on, after you have pressed the ON/OFF (marche/arrêt) button to stop the unit, the fan will keep un running for about 2 min. to blow away the water on the evaporator, thus eliminating risk of mildew.

### (9). Setting health function

In unit on status, press  button to set health function.





When  is displayed, health function is on.

When you cancel the HEALTH mode by pressing again on the button, the icon will disappear.

Health function is available when the unit is equipped with anion generator. When health function is on, the anion generator will start operation, absorbing the dusts and killing the bacteria in the room.



## User's Manual of Remote Control

### (10). Setting air function

Press  button until  is displayed, then air function is turned on.  
 Press  button until  is disappeared, then air function is turned off.  
 When the indoor unit is connected with fresh air valve, air function setting can control the connection of fresh air valve, which can control the fresh air volume and improve the air quality inside the room.

### (11). Setting sleep function



In unit on status, press SLEEP button to turn on or turn off sleep function.

- ◆ When  is displayed, sleep function is on.
- ◆ When  is not displayed, sleep function is off.

#### Notes:

- ①. Sleep function can not be set in auto and fan mode;
- ②. When turning off the unit or switching mode, sleep function is cancelled;

### (12). Setting I FEEL function

In unit on status, press I FEEL button to turn on or turn off I FEEL function.  
 When  is displayed, I FEEL function is on.  
 When  is not displayed, I FEEL function is off.  
 When I FEEL function is turned on, the unit will adjust temperature according to the temperature detected by the remote controller to achieve the best air-conditioning effect. In this case, you should place the remote controller within the valid receiving range.

### (13). Setting timer

You can set the operation time of unit as you need. You can also set timer on and timer off in combination.  
 Before setting, check if the time of the system is the same as the current time. If not, please set the time according to current time.

#### 1). Setting timer off

- ①. Pressing TOFF button, "OFF" is blinking and time displaying zone displays the timer time of last setting.
- ②. Press  $\Delta$  or  $\nabla$  button to adjust the timer time.
- ③. Press TOFF button again to confirm setting. OFF is displayed and time displaying zone resumes to display current time.





## Using the Remote control

- ④. Press TOFF button again to cancel timer and OFF is not displayed.
  - 2). Setting timer on
- ①. Pressing TON button, "ON" is blinking and time displaying zone displays the timer time of last setting.
- ②. Press  $\Delta$  or  $\nabla$  button to adjust the timer time.
- ③. Press TON button again to confirm setting. ON is displayed and time displaying zone resumes to display current time.
- ④. Press TON button again to cancel timer and ON is not displayed.

### 1.4 Special function buttons

#### (1). Setting child lock

Press  $\Delta$  and  $\nabla$  buttons simultaneously to lock the buttons on remote control and is displayed .

Press  $\Delta$  and  $\nabla$  buttons simultaneously again to unlock the buttons on remote control and  is not displayed .



If the buttons are locked,  blinks 3 times when pressing the button and any operation on the button is invalid.

#### (2). Switching temperature scale

In unit off status, press MODE button and  $\nabla$  button simultaneously to switch temperature scale between °C and °F.

#### (3). Setting energy-saving function

In unit on status and under cool mode, press CLOCK and TEMP buttons simultaneously to enter energy-saving mode.

- ◆ When  is displayed, energy-saving function is on.
- ◆ When  is not displayed, energy-saving function is off.

If you want to turn off the energy-saving function, press again on CLOCK and TEMP buttons and  is no longer displayed.

**Note:** energy-saving function is only available in cooling mode and it will be exited when switching mode or setting sleep function.

#### (4). Absence function

In unit on status and under heat mode, press CLOCK and TEMP buttons simultaneously to enter absence function. Temperature displaying zone displays 8 and  is displayed.

Press CLOCK and TEMP buttons simultaneously again to exit absence function. Temperature displaying zone resumes previous display and is not displayed.

## Using the Remote Control

In winter, absence function can keep the indoor ambient temperature above 0°C to avoid freezing.

**Note:** Absence function is only available in heating mode and it will be exited when switching mode or setting sleep function.

### 1.5 Replacing batteries in remote control

- (1). Lift the cover along the direction of arrow (as shown in Fig 1 ①).
- (2). Take out the original batteries (as shown in Fig 1 ②).
- (3). Place two 7# (AAA 1.5V) dry batteries, and make sure the position of + and - terminals is correct (as shown in Fig 2 ③).
- (4). Reinstall the cover (as shown in Fig 2 ④).

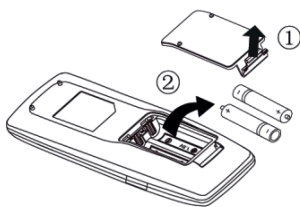

Fig.1

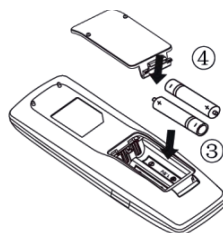



Fig.2

#### Notes:

- ①. The remote controller should be placed 1m away from the TV set or stereo sound sets.
- ②. The operation of remote controller should be performed within its receiving range.
- ③. If you need to control the main unit, please point the remote controller at the signal receiving window of the main unit to improve the receiving sensibility of main unit.
- ④. When the remote controller is sending signal, “” icon will be blinking for 1 second. When the main unit receives valid remote control signal, it will give out a sound.
- ⑤. If the remote controller does not operate normally, please take the batteries out and reinsert them after 30 seconds. If it still can't operate properly, replace the batteries.
- ⑥. When replacing the batteries, do not use old or different types of batteries, otherwise, it may cause malfunction.
- ⑦. When you won't use the remote controller for a long time, please take out the batteries.

## Emergency operation

If the remote control is lost or damaged, please use auxiliary button to turn on or turn off the air conditioner. As shown in the figure, open the panel, press the auxiliary button to turn on or turn off the air conditioner. When the air conditioner is turned on, it will operate under auto mode.

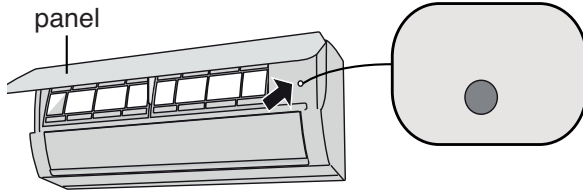

### WARNING

Use insulated object to press the auto button

## Clean and Maintenance



### WARNING

- Turn off the air conditioner and disconnect the power before cleaning the unit to avoid electric shock.
- Do not wash the air conditioner with water to avoid electric shock.
- Do not use volatile liquid to clean the air conditioner.

## Clean surface of indoor unit

When the surface of indoor unit is dirty, it is recommended to use a soft dry cloth or lightly moistened with water to wipe it.

### NOTICE:

- Do not remove the panel when cleaning it.

## Clean and maintenance

### Clean filter

#### 1 Open panel

Open the panel into a certain angle (less than 60°, do not force the panel) along the arrow direction from the two sides of panel.



#### 2 Remove filter

Remove the filter as indicated.

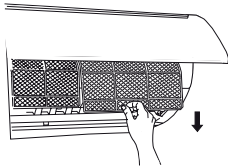

#### 3 Clean filter

- Use a vacuum or water to clean the filter.
- When the filter is very dirty, use water (below 45 °c ) to clean it, and then put it in a shady and cool place to dry.

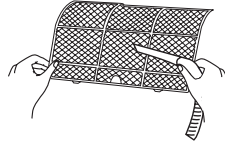

#### 4 Install filter

Install the filter and then close the panel cover tightly.

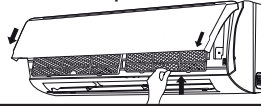

### WARNING

- The filter should be cleaned every three months. If the unit operates in a highly dusty environment, clean frequency should be increased.
- After removing the filter, do not touch fins to avoid injury.
- Do not use fire or hair dryer to dry the filter to avoid deformation or fire hazard.

## Clean and Maintenance

1. Check that air inlets and air outlets are not blocked.
2. Check if circuit breaker and connection, are in good condition.
3. Check that filters are clean.
4. Check that drainage pipe is not damaged.

1. Disconnect power supply.
2. Clean filters and indoor unit's panel.
3. Check whether mounting bracket for outdoor unit is damaged or corroded.  
If yes, please contact dealer.

### Notice for recovery

1. Many packing materials are recyclable.  
Please dispose of them in appropriate recycling bin.
2. If you want to get rid of the air conditioner, please contact local dealer or recycling service center for the correct disposal method.

### Malfunction analysis

Please check below items before asking for maintenance. If the malfunction still can't be eliminated, please contact local dealer or qualified professionals.

| Problem   | Check items  | Solution  |
|---|--|---|
| Indoor unit can't receive remote control signal or remote control has no power. | Whether it's interfered severely (such as static electricity, stable voltage)? | Cut the power supply off and put the power back after about 3min, and then turn on the unit again.  |
|   | Whether remote control is within the signal receiving range?                   | Signal receiving range is 8m.   |
|   | Whether there are obstacles?   | Remove obstacles.   |
|   | Whether remote control is pointing at the receiving window?                    | Select proper angle and point the remote control at the receiving window on indoor unit.  |
|   | Is the remote control display fuzzy or there is no display at all ?            | Check the batteries. If the battery charge level is too low, please replace them.   |
|   | No display when operating the remote control?                                  | Check whether remote control appears to be damaged. If yes, replace it.   |
|   | Fluorescent lamp in the room?  | Bring the remote control close to the indoor unit.<br><br>Turn off the fluorescent lamp and then try it again.  |
| No air flow from indoor unit  | Are air inlet or air outlet of indoor unit blocked?                            | Eliminate obstacles.  |
|   | Under heating mode, indoor temperature reached set temperature?                | After reaching set temperature, indoor unit will stop blowing out air.  |
|   | Has the heating mode been just turned on ?                                     | In heating mode, in order to prevent blowing out cold air, indoor unit will start several minutes after the unit has been turned on, which is normal. |

**Malfunction analysis**

| <b>Problem</b>                | <b>Check items</b>  | <b>Solution</b>                                 |
|-------------------------------|---|---|
| Air conditioner can't operate | Power failure?  | Wait until power resumes.                       |
|                               | Air switch trips off ?  | Ask professional to replace air switch.         |
|                               | Wiring has malfunction?                                       | Ask professional to replace it.                 |
|                               | Has the unit been turned on immediately after being stopped ? | Wait for 3min, and then turn on the unit again. |
|                               | Is the function setting on remote control correct ?           | Reset the function.                             |

|   |  |   |
|---|--|---|
| Mist is emitted from indoor unit's air outlet | Are indoor temperature and humidity level high ? | This is because indoor air is cooled rapidly. After a while, indoor temperature and humidity level will decrease and mist will disappear. |
|---|--|---|

|                                   |  |  |
|-----------------------------------|--|--|
| Set temperature can't be adjusted | Unit is operating under auto mode?                           | Temperature can't be adjusted under auto mode. Please switch the operation mode if you need to adjust temperature. |
|                                   | Your required temperature exceeds the set temperature range? | Set temperature range: 15°C -30 °C .   |

|  |                                     |   |
|--|-------------------------------------|---|
| Air cooling (heating) is not efficient | Voltage is too low?                 | Wait until the voltage resumes to normal. |
|  | Filter is dirty?                    | Clean the filter.                         |
|  | Set temperature is in proper range? | Adjust temperature to proper range.       |
|  | Doors and windows are open?         | Close doors and windows.                  |

### Malfunction analysis

| Problem   | Check items  | Solution   |
|---|--|--|
| Odours are emitted                                      | Either there is an odour source in the room, such as furniture or cigarette, or the filter is dirty. | Eliminate the source of the odour.<br>Clean the filter.  |
| Air conditioner suddenly turns on and operates normally | There may be interference, such as thunder, wireless devices, etc.                                   | Cut the power supply off and put the power back and then turn on the unit again.   |
| Outdoor unit emits vapor                                | Heating mode is turned on?   | During defrosting under heating mode, it may produce vapor, which is a normal.   |
| Water flowing noise                                     | Has the air conditioner just been turned on and off?   | The noise is the sound of refrigerant flowing inside the unit, which is a normal.  |
| Craking noise   | Has the air conditioner just been turned on and off?   | This is the sound of friction caused by expansion and/or contraction of panel or other parts due to the change of temperature. |



## Malfunction analysis

### Error code

When air conditioner status is abnormal, temperature indicator on indoor unit will blink and display corresponding error code. Please refer to list below for identification of error code.

| Error code | Troubleshooting  |
|------------|--|
| E5         | It can be eliminated after restarting the unit. If not , please contact qualified professionals for service. |
| E6         | It can be eliminated after restarting the unit. If not , please contact qualified professionals for service. |
| E8         | It can be eliminated after restarting the unit. If not,please contact qualified professionals for service.   |
| U8         | It can be eliminated after restarting the unit. If not,please contact qualified professionals for service.   |
| H6         | It can be eliminated after restarting the unit. If not,please contact qualified professionals for service.   |
| C5         | Please contact qualified professionals for service.  |
| F1         | Please contact qualified professionals for service.  |
| F2         | Please contact qualified professionals for service.  |

Note: If there're other error codes, please contact qualified professionals for service.

### **⚠ WARNING**

- When situations below happen, please turn off the air conditioner and disconnect power immediately, then contact the dealer or qualified professionals for service.
- There is an unusual sound during operation.
- Air switch trips off frequently.
- Air conditioner generates a burning smell.
- Indoor unit is leaking.

### **ATTENTION:**

- Do not repair or refit the air conditioner by yourself.
- If the air conditioner operates under abnormal conditions, it may damage the unit, or cause electric shock or fire hazard.

### Installation dimension diagram

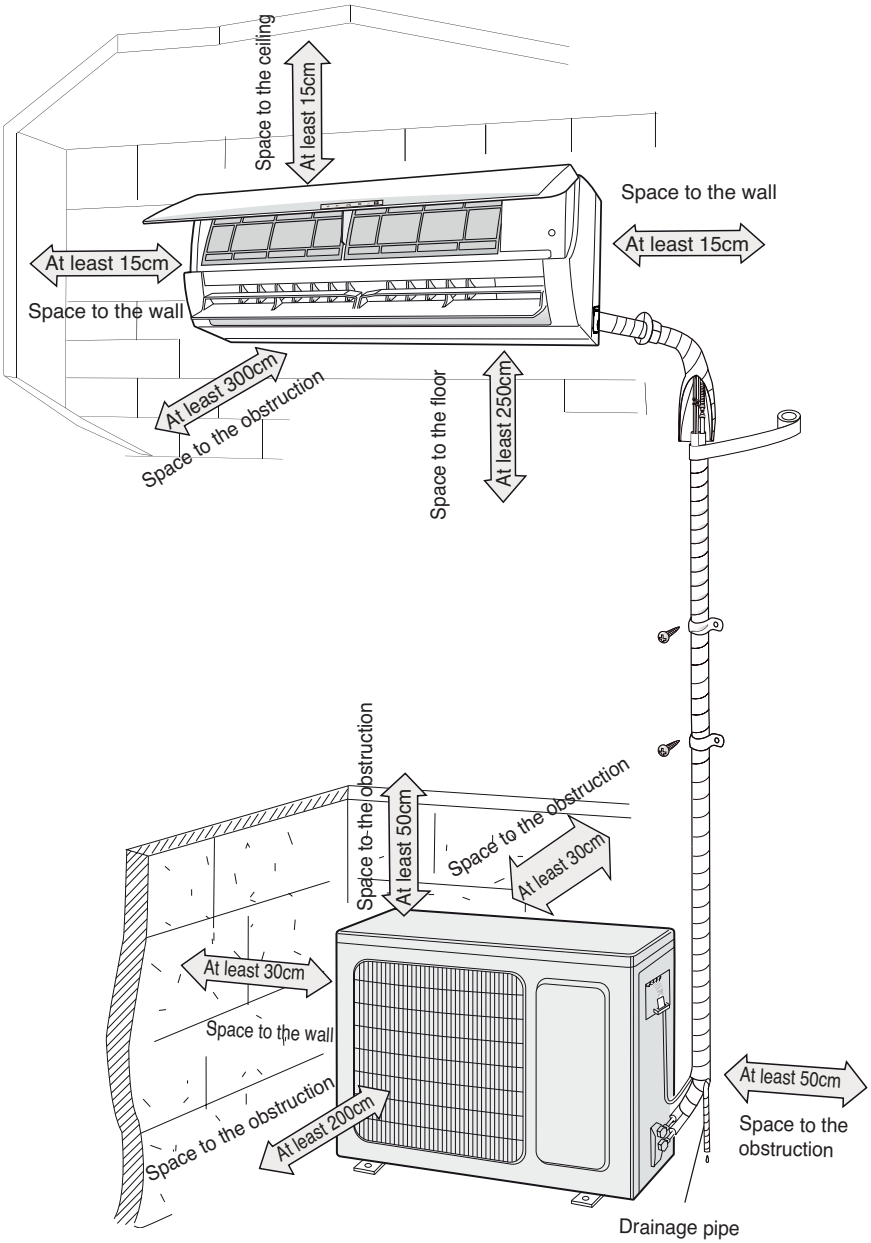

## Tools for installation

|                          |                   |                    |
|--------------------------|-------------------|--------------------|
| 1 Level meter            | 2 Screw driver    | 3 Impact drill     |
| 4 Drill head             | 5 Pipe expander   | 6 Torque wrench    |
| 7 Open-end wrench        | 8 Pipe cutter     | 9 Leakage detector |
| 10 Vacuum pump           | 11 Manometer      | 12 Universal meter |
| 13 Inner hexagon spanner | 14 Measuring tape |                    |

### Note:

- Contact your local agent or a certified technician for installation.

## Selection of installation location

### Basic requirement

Installing the unit in the following places may cause malfunction. If it is unavoidable, please consult your local dealer or a certified technician:

1. A place with strong heat sources, vapors, flammable or explosive gas, or volatile objects spread in the air.
2. A place with high-frequency devices (such as welding machine, medical equipment).
3. A place near coast area.
4. A place with oil or fumes in the air.
5. A place with sulphurous gas.
6. Other places with special environment.
7. The appliance cannot be installed in a laundry.

### Indoor unit

1. There should be no obstruction near air inlet and air outlet.
2. Select a location where the condensation water can be dispersed easily and won't affect people.
3. Select a location which is convenient to connect the outdoor unit and the closest possible to the power supply.
4. Select a location which is out of reach for children.
5. The location should be able to withstand the weight of indoor unit and won't increase noise and vibration.
6. The appliance must be installed 2.5m above floor.
7. Don't install the indoor unit right above an electric appliance.
8. Please try your best to keep the unit away from fluorescent lamps.

### Outdoor unit

1. Select a location where the noise and outflow air emitted by the outdoor unit will not affect neighborhood.
2. The location should be well ventilated and dry, where the outdoor unit won't be exposed directly to sunlight or strong wind.
3. The location should be able to withstand the weight of outdoor unit.
4. Make sure that the installation follows the requirement of installation dimension diagram.
5. Select a location which is out of reach for children and far away from animals or plants. If it is unavoidable, please add a fence for safety purpose.

## Requirements for electric connection

### Safety precaution

1. Must follow the electric safety regulations when installing the unit.
2. According to the local safety regulations, use qualified power supply circuit and air switch.
3. Make sure the power supply matches with the requirement of air conditioner. Unstable power supply or incorrect wiring may cause mal function and damage the unit.
4. Properly connect the live wire, neutral wire and grounding wire
5. To work safely, be sure to cut off the power supply before proceeding any work related to electricity.
6. Do not put through the power before finishing installation.
7. The temperature of refrigerant circuit will be high, please keep the interconnection cable away from the copper tube.
8. The appliance shall be installed in accordance with national wiring regulations.

### Grounding requirement

1. The air conditioner is a first class electric appliance. It must be properly grounded with specialized grounding device by a professional. Please make sure it is always grounded effectively, otherwise it may cause electric shock.
2. The yellow-green wire in air conditioner is the grounding wire, which can't be used for other purposes.
3. The grounding resistance should comply with national electric safety regulations.
4. An all-pole disconnection switch having a contact separation of at least 3mm in all poles should be connected in fixed wiring.

## Installation of indoor unit

### Step One: choosing installation location

Recommend the installation location to the client and then confirm it with the client.

### Step Two: install wall-mounting frame

1. Hang the wall-mounting frame on the wall; adjust it in horizontal position with the level meter and then point out the screw fixing holes on the wall.
2. Drill the screw fixing holes on the wall with the impact drill (the specification of drill head should be the same as the plastic expansion particle) and then fill the plastic expansion particles in the holes.
3. Fix the wall-mounting frame on the wall with tapping screws (ST4.2X25TA) and then check if the frame is firmly installed by pulling the frame. If the plastic expansion particle is loose, please drill another fixing hole nearby.

### Step Three: open piping hole

1. Choose the position of piping hole according to the direction of outlet pipe. The position of piping hole should be a little lower than the wall-mounted frame, shown as below.

09K:

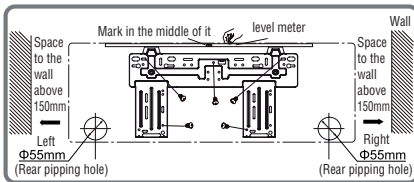

12K:

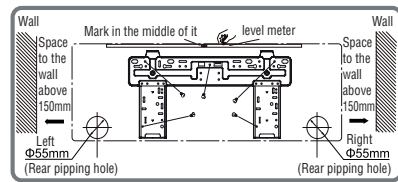

18K:

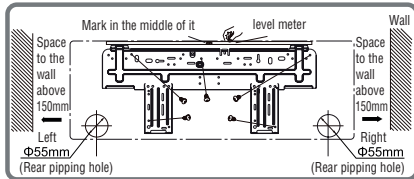

24K:

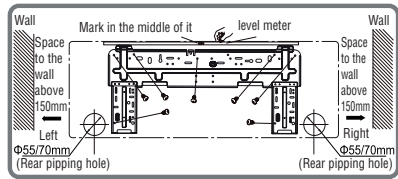

2. Open a piping hole with the diameter of  $\Phi 55$  or  $\Phi 70$  on the selected outlet pipe position. In order to drain smoothly, slant the piping hole on the wall slightly downward to the outdoor side with the gradient of 5-10°.

## Installation of the indoor unit

### Note:

- Pay attention to dust prevention and take relevant safety measures when opening the hole.
- The plastic expansion particles are not provided and should be bought locally.

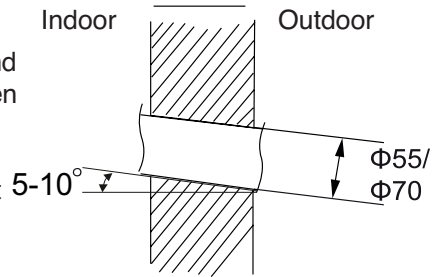

### Step Four: outlet pipe

1. The pipe can be led out in the direction of right, rear right, left or rear left.

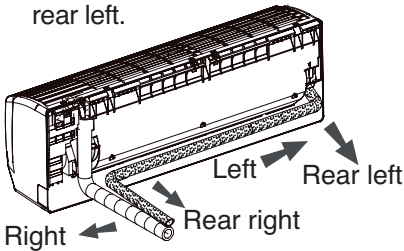

2. When select leading out the pipe from left or right, please cut off the corresponding hole on the bottom case.

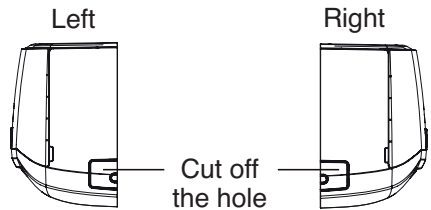

### Step Five: connect the pipe of indoor unit

1. Aim the pipe joint at the corresponding bell mouth.

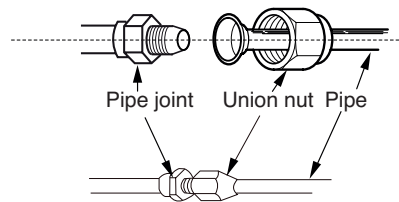

2. Pretightening the union nut with hand.

3. Adjust the torque force by referring to the following sheet. Place the open-end wrench on the pipe joint and place the torque wrench on the union nut. Tighten the union nut with torque wrench.

### Installation of indoor unit

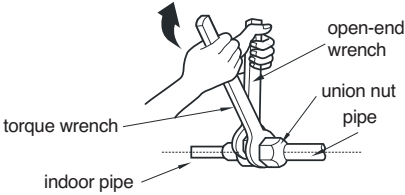

| Hex nut diameter | Tightening torque (N-m) |
|------------------|-------------------------|
| Φ 6              | 15~20                   |
| Φ 9.52           | 30~40                   |
| Φ 12             | 45~55                   |
| Φ 16             | 60~65                   |
| Φ 19             | 70~75                   |

4. Wrap the indoor pipe and joint of connection pipe with insulating pipe, and then wrap it with tape.

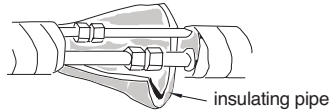

### Step Six: install drain hose

1. Connect the drain hose to the outlet pipe of indoor unit.

2. Bind the joint with tape.

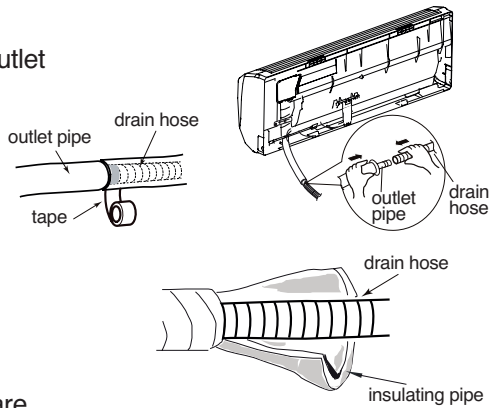

#### Note:

- Add insulating pipe in the indoor drain hose in order to prevent condensation.
- The plastic expansion particles are not provided.

### Step Seven: connect wire of indoor unit

1. Open the panel, remove the screw on the wiring cover and then take down the cover.

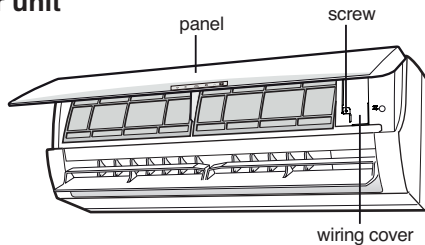

## Installation of indoor unit

2. Make the power connection wire go through the cable-cross hole at the back of indoor unit and then pull it out from the front side.

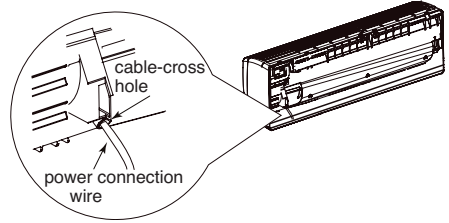

3. Remove the wire clip; connect the power connection wire to the wiring terminal according to the color; tighten the screw and then fix the power connection wire with wire clip. After finishing wiring, clamp the grounding wire (yellow-green wire) into the wire-crossing groove as shown in the following figure, in order to avoid pressing the wire when closing the electric box cover.

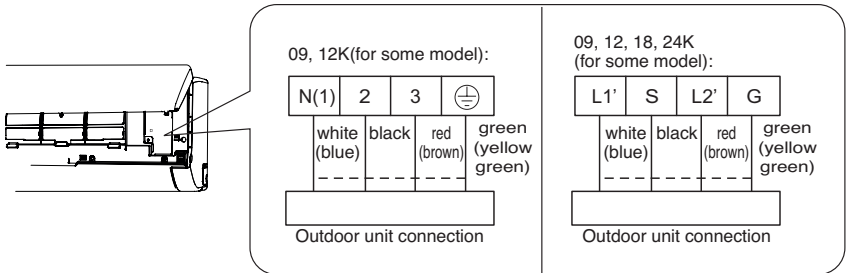

**Note: the wiring board is for reference only, please refer to the actual one.**

4. Put wiring cover back and then tighten the screw  
5. Close the panel.

### Note:

- All wires of indoor unit and outdoor unit should be connected by a professional.
- If the length of power connection wire is insufficient, please contact the supplier for a new one. Avoid extending the wire by yourself.
- An air switch must be installed in the line. The air switch should be all-pole parting and the contact parting distance should be more than 3mm.



## Installation of indoor unit

### Step Eight: bind up pipe

1. Bind up the connection pipe, power cord and drain hose with the band.

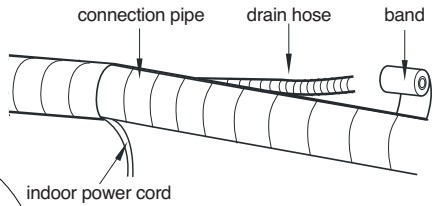
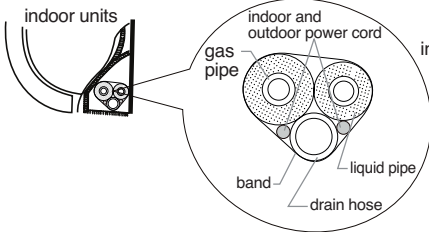

2. Reserve a certain length of drain hose and power cord for installation when binding them. When binding to a certain degree, separate the indoor power and then separate the drain hose.

3. Bind them evenly.
4. The liquid pipe and gas pipe should be bound separately at the end.

#### Note:

- The power cord and control wire can't be crossed or winded.
- The drain hose should be bound at the bottom.

### Step Nine: hang the indoor unit

1. Put the bound pipes in the wall pipe and then make them pass through the wall hole.
2. Hang the indoor unit on the wall-mounting frame.
3. Stuff the gap between pipes and wall hole with sealing gum.
4. Fix the wall pipe.
5. Check if the indoor unit is installed firmly and close to the wall.

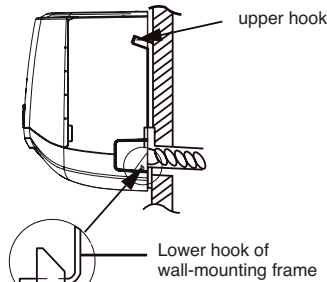
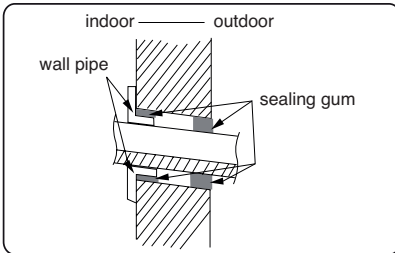

#### Note:

- Do not bend the drain hose too excessively in order to prevent blocking.

## Installation of outdoor unit

### Step one: fix the support of outdoor unit (select it according to the actual installation situation)

1. Select installation location according to the house structure.
2. Fix the support of outdoor unit on the selected location with expansion screws.

#### Note:

- Take sufficient protective measures when installing the outdoor unit.
- Make sure the support can withstand at least four times the unit weight.
- The outdoor unit should be installed at least 3cm above the floor in order to install drain joint.
- Expansion screws needed per type of unit:

| Cooling capacity | # screws |
|------------------|----------|
| 2300-5000W       | 6        |
| 6000-8000W       | 8        |
| 10000-16000W     | 10       |

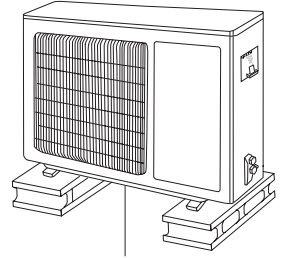

at least 3cm above the floor

### Step two: install drain joint (Only for cooling and heating unit)

1. Connect the outdoor drain joint into the hole on the chassis, as shown in the picture below.
2. Connect the drain hose into the drain vent.

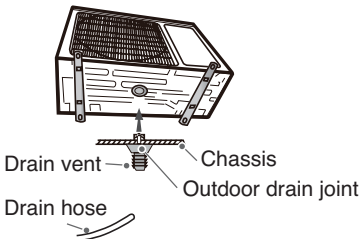

### Step three: fix outdoor unit

1. Place the outdoor unit on the support.
2. Fix the foot holes of outdoor unit with bolts.

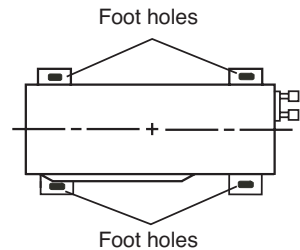

**Installation of outdoor unit**

**Step four: connect indoor and outdoor pipes**

1. Remove the screw on the right handle of outdoor unit and then remove the handle.

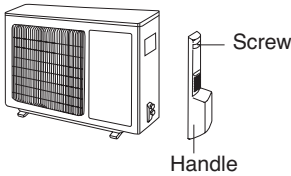

3. Pretighten the union nut with hand.

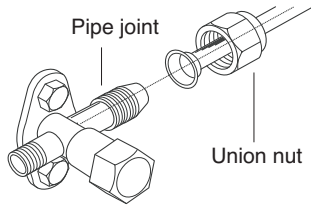

2. Remove the screw cap of valve and aim the pipe joint at the bell mouth of pipe.

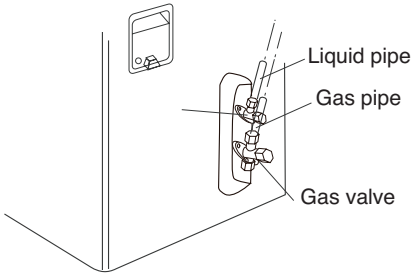

4. Tighten the union nut with torque wrench by referring to the sheet below.

| HEX NUT DIAMETER | TIGHTENING TORQUE (N·M) |
|------------------|-------------------------|
| Φ 6              | 15~20                   |
| Φ 9.52           | 30~40                   |
| Φ 12             | 45~55                   |
| Φ 16             | 60~65                   |
| Φ 19             | 70~75                   |

**Step five: connect outdoor electric wire**

1. Remove the wire clip; connect the power connection wire and signal control wire (only for heating unit) to the wiring terminal according to the color; fix them with screws.

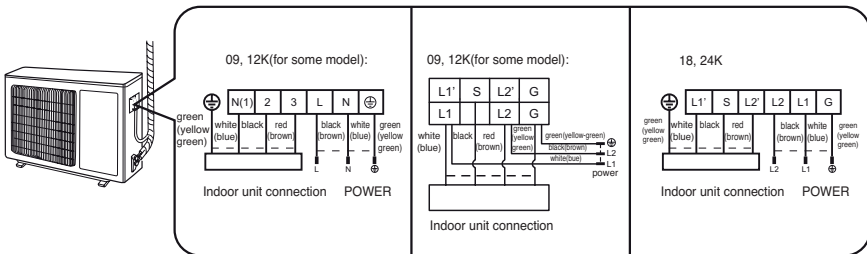

Note: the wiring board is for reference only, please refer to the actual one.

**Installation of outdoor unit**

- Fix the power connection wire and signal control wire with wire clip (only for cooling and heating unit).

**Note:**

- After tightening the screw, pull the power cord slightly to check if it is solid.
- Never cut the power connection wire to extend or shorten the distance.

**Step Six: Pipe arrangement**

- The pipes should be placed along the wall, bent reasonably and hidden possibly. Min. semi-diameter of bending the pipe is 10cm.
- If the outdoor unit is higher than the wall hole, you must set a U-shaped curve in the pipe before pipe goes into the room, in order to prevent rain from getting into the room.

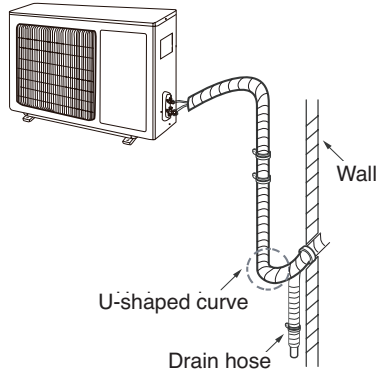

**NOTES:**

- The through-wall height of drain hose shouldn't be higher than the outlet pipe hole of indoor unit.
- Slant the drain hose slightly downwards; the drain hose can't be curved, raised, wavy, etc.

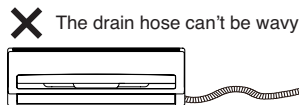
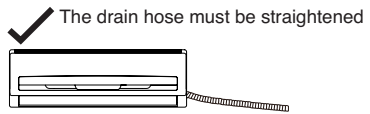
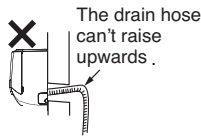
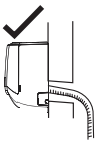

- The water outlet can't be placed in water in order to drain smoothly.

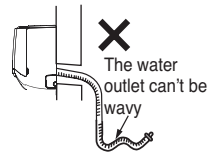
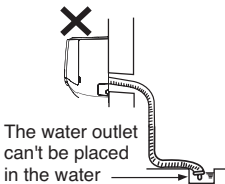

## Vacuum pumping

### Use vacuum pumping

1. Remove the valve caps on the liquid valve and gas valve and the nut of refrigerant charging vent.
2. Connect the charging hose of piezometer to the refrigerant charging vent of gas valve and then connect the other charging hose to the vacuum pump.
3. Open the piezometer completely and operate for 10-15min to check if the pressure of piezometer remains in  $-0.1$  MPa.
4. Close the vacuum pump and maintain this status for 1-2min to check if the pressure of piezometer remains in  $-0.1$  MPa. If the pressure decreases, there may be leakage.
5. Remove the piezometer, open the valve core of liquid valve and gas valve completely with inner hexagon spanner.
6. Tighten the screw caps of valves and refrigerant charging vent.

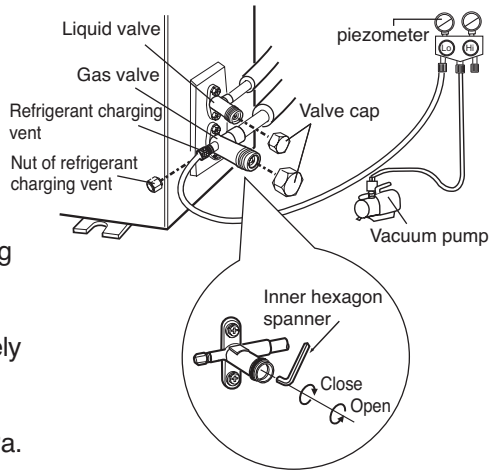

## Leakage detection

1. With a leakage detector, check if there is leakage.
2. If leakage detector is not available, please use soap water for leakage detection.  
Apply soap water at the suspected position and keep the soap water for more than 3min. If there are air bubbles coming out of this position, there's a leakage.

## Check after installation

- Check according to following after finishing installation.

| Items to be checked  | Possible malfunction                                  |
|--|---|
| Has the unit been installed solidly?   | The unit may drop, shake or emit noise.               |
| Have you done the refrigerant leakage test?                                      | It may cause insufficient cooling (heating) capacity. |
| Is heat insulation of pipeline sufficient?                                       | It may cause condensation and water dripping.         |
| Is water drained well?   | It may cause condensation and water dripping.         |
| Is the voltage of power supply according to the voltage marked on the nameplate? | It may cause malfunction or damaging the parts.       |
| Is electric wiring and pipeline installed correctly?                             | It may cause malfunction or damaging the parts.       |
| Is the unit grounded securely?   | It may cause electric leakage.                        |
| Does the power wire follow the specification?                                    | It may cause malfunction or damaging the parts.       |
| Is there any obstruction in the air inlet and outlet?                            | It may cause insufficient cooling (heating) capacity. |
| The dust and sundries caused during installation are removed?                    | It may cause malfunction or damaging the parts.       |
| The gas valve and liquid valve of connection pipe are open completely?           | It may cause insufficient cooling (heating) capacity. |

## Check after installation

### 1. Preparation of test operation

- The client approves the air conditioner.
- Specify the important notes for air conditioner to the client.

### 2. Method of test operation

- Put through the power, press ON/OFF button on the remote controller to start operation.
- Press MODE button to select AUTO, COOL, DRY, FAN and HEAT to check whether the operation is normal or not.
- If the ambient temperature is lower than 16°C, the air conditioner can't start cooling.

### Configuration of connecting pipe

1. Standard length of connection pipe
  - 5m, 7.5m, 8m.
2. Min. length of connection pipe is 3m.
3. Max. length of connection pipe and max. rising difference.

| Cooling capacity      | Max length of connection pipe | Max rising difference | Cooling capacity       | Max length of connection pipe | Max rising difference |
|-----------------------|-------------------------------|-----------------------|------------------------|-------------------------------|-----------------------|
| 9000Btu/h<br>(2637W)  | 20                            | 10                    | 24000Btu/h<br>(7032W)  | 25                            | 10                    |
| 12000Btu/h<br>(3516W) | 20                            | 10                    | 28000Btu/h<br>(8204W)  | 30                            | 10                    |
| 18000Btu/h<br>(5274W) | 25                            | 10                    | 36000Btu/h<br>(10548W) | 30                            | 20                    |
|                       |                               |                       | 42000Btu/h<br>(12306W) | 30                            | 20                    |
|                       |                               |                       | 48000Btu/h<br>(14064W) | 30                            | 20                    |

## Configuration of connection pipe

### 4. Additional refrigerant liquid and refrigerant charging required after extending connection pipe

- The calculation method of additional refrigerant charging amount (on the basis of liquid pipe):  
 Additional refrigerant charging quantity = prolonged length of liquid pipe x additional refrigerant charging amount per meter
- Based on the length and diameter of standard pipe, add refrigerant as per the following chart.

Additional refrigerant charging amount for , R410A

| Diameter of connection pipe |                | Outdoor unit throttle |                          |
|-----------------------------|----------------|-----------------------|--------------------------|
| Liquid pipe (mm)            | Gas pipe (mm)  | Cooling only(g/m)     | Cooling and heating(g/m) |
| ∅6                          | ∅9.52 or ∅12   | 15                    | 20                       |
| ∅6 or ∅9.52                 | ∅16 or ∅19     | 15                    | 50                       |
| ∅12                         | ∅19 or ∅22.2   | 30                    | 120                      |
| ∅16                         | ∅25.4 or ∅31.8 | 60                    | 120                      |
| ∅19                         | -              | 250                   | 250                      |
| ∅22.2                       | -              | 350                   | 350                      |



## Pipe expanding method

### Note:

Improper pipe expanding is the main cause of refrigerant leakage. Please expand the pipe according to the following steps:

### A: Cut the pipe

- Confirm the pipe length according to the distance of indoor unit and outdoor unit.
- Cut the required pipe with pipe cutter.

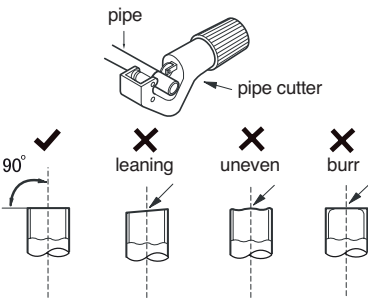

### B: Remove the burrs

- Remove the burrs with shaper and prevent the burrs from getting into the pipe.

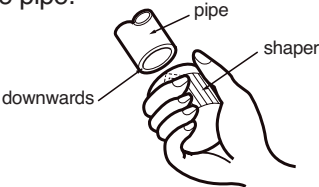

### C: Put on suitable insulating pipe

### D: Put on the union nut

- Remove the union nut on the indoor connection pipe and outdoor valve; install the union nut on the pipe.

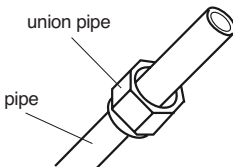

### E: Expand the port

- Expand the port with expander.

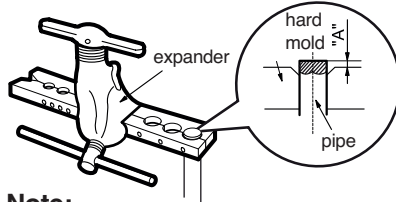

### Note:

- "A" varies according to the diameter, please refer to the sheet below:

| Outer diameter<br>(mm) | A (mm) |     |
|------------------------|--------|-----|
|                        | Max    | Min |
| ∅6-6.35(1/4")          | 1.3    | 0.7 |
| ∅9.52(3/8")            | 1.6    | 1.0 |
| ∅12-12.7(1/2")         | 1.8    | 1.0 |
| ∅15.8-16(5/8")         | 2.4    | 2.2 |

### F: Inspection

- Check the quality of expanding port. If there is any blemish, expand the port again according to the steps above.

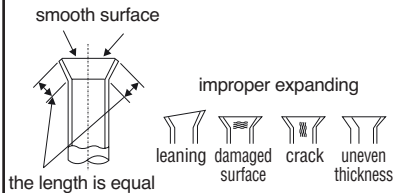

## Wired Remote Control

**Note: The Wired Remote Control is only available on some models.**

### 1 LCD Symbols

#### 1.1 Outside View of the Wired Remote Control



#### 1.2 Wired Remote Control LCD Screen

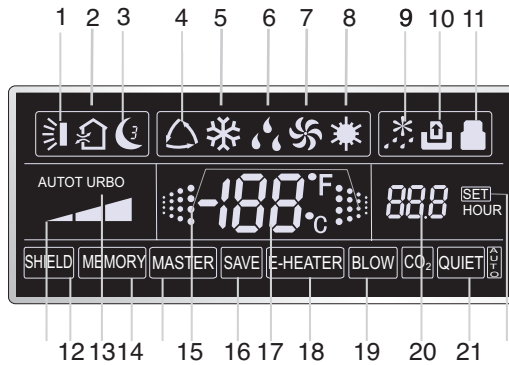

**Wired Remote Control**

| No. | Symbols    | Description   |
|-----|------------|---|
| 1   |            | Swing function.   |
| 2   |            | Air exchange function (not available on this model)   |
| 3   |            | Sleep function (only Sleep 1)   |
| 4   |            | Indoor unit running modes (Cool, Dry, Fan and Heat)   |
| 5   |            | Cooling mode  |
| 6   |            | Dry mode  |
| 7   |            | Fan mode  |
| 8   |            | Heating mode  |
| 9   |            | Outdoor unit defrosting function  |
| 10  |            | Gate-control function (not available for this unit)   |
| 11  |            | Lock function.  |
| 12  | SHIELD     | Shield functions : buttons, temperature, On/Off or Mode is shielded by the remote monitor             |
| 13  | AUTO TURBO | Turbo function.   |
| 14  | MEMORY     | Memory function (the indoor unit resumes the original setting after power failure and power recovery) |
| 15  |            | Blinks under ON status of the unit without touching any button.                                       |
| 16  | SAVE       | Energy-saving function (not available for this unit)  |
| 17  |            | Ambient/Presets temperature value   |
| 18  | E-HEATER   | Electric auxiliary heating function.  |
| 19  | BLOW       | Blow function.  |
| 20  |            | Time value  |
| 21  | QUIET      | Quiet function (two types: Quiet and Auto Quiet) (not available for this unit)                        |

## Wired Remote Control

2 Buttons

### 2.1 Wired Remote Control Buttons

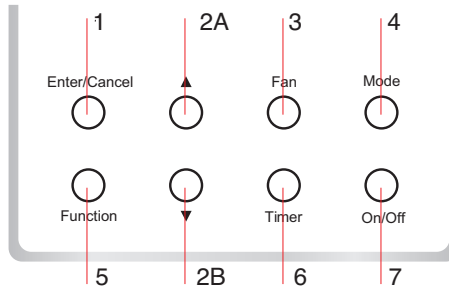

### 2.2 Button Functions

|       |              |  |
|-------|--------------|--|
| 1     | Enter/Cancel | Select and cancel a function   |
| 2A    | ▲            | Set running temperature for the indoor unit, range: 16 ~ 30°C and  |
| 2B    | ▼            | Set timer, range: 0.5 – 24 hr.   |
| 3     | Fan          | Set fan speed: High/Middle/Low/Auto  |
| 4     | Mode         | Set indoor unit mode: Cool/Heat/Fan/Dry/Auto   |
| 5     | Function     | Switch functions: Turbo/Save/E-heater/Blow etc.  |
| 6     | Timer        | Set timer  |
| 7     | On/Off       | Turn indoor unit on/off  |
| 4+2A  | ▲+Mode       | Press together for 5 sec. when the unit is off to Enter/Cancel the Memory function. If Memory is set, the indoor unit will go back to the original setting after a power failure and power recovery. If not, the indoor unit will turn off by default after power recovery. Memory is set to off as default at time of delivery. |
| 3+2B  | Fan+▼        | Press together when the unit is off, ❄️ is displayed on the wired remote control for a cooling only unit, while 🔥 is displayed on the wired remote control for a cooling and heating unit.   |
| 2A+2B | ▲+▼          | When starting the unit, press together for 5 sec. to turn on the Lock, which means that buttons are locked and disabled. Press together again for 5 sec. to unlock.  |

## 3 Operating Instructions

### 3.1 On/Off

Press "On/Off" to turn the unit on. Turn it off by pressing it again.

**Note:** Fig.4 shows that the unit is off after the on/off button has been pressed.

Fig.5 shows that the unit is on after the on/off button has been pressed again.

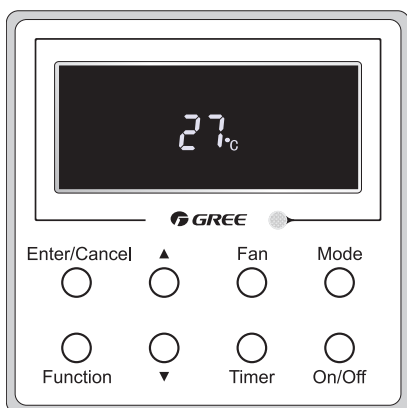

Fig. 4 "Off" Status

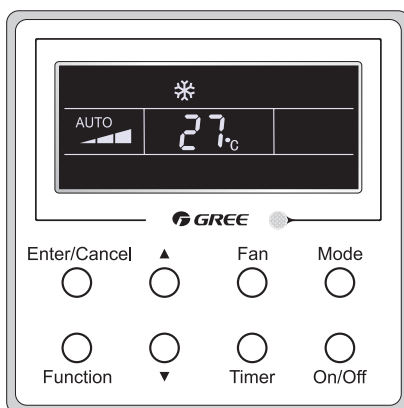

Fig. 5 "On" Status

### 3.2 Mode Setting

When the unit is on, press "Mode" to change operating modes in the following sequence:



### 3.3 Temperature Setting

Press ▲ or ▼ to increase/decrease the preset temperature. Hold either button down to increase or decrease the temperature by 1°C every 0.5 sec., as shown in Fig.6. In the Cool, Dry, Fan or Heat mode, the temperature setting range is 16°C-30°C. In Auto mode, the temperature is not adjustable.

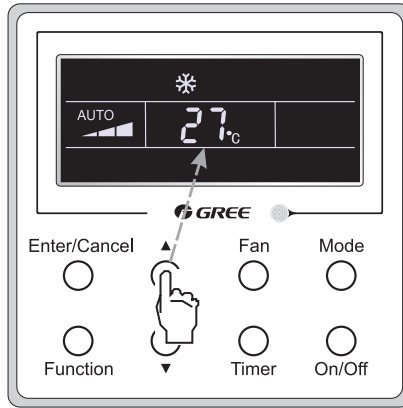

Fig.6

### 3.4 Fan Setting

When the unit is on or off, press “Fan” to change the fan speed on the indoor unit in the sequence shown in Fig.7.

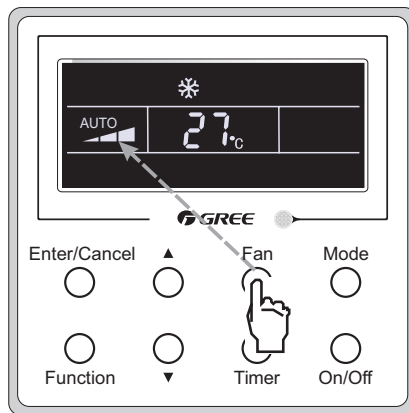

Fig.7

### 3.5 Timer Setting

When the unit is on or off, press “Timer” to set the time when the unit will go on or off. To set Timer On: press “Timer” and the LCD will display “xx.x hour,” with “hour” flashing. Press ▲ or ▼ to change the time value. Then press Enter/Cancel to confirm the setting.

To set Timer Off: press “Timer”. If the LCD doesn’t display “xx.x hour,” it means the timer setting is canceled.

Setting the Timer Off time with the unit on is shown in Fig.8.

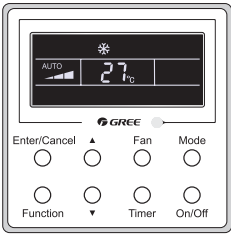

Turn on the unit, without setting timer

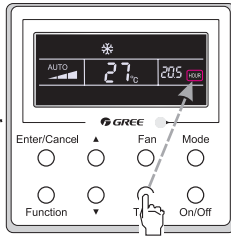

Press (Timer) button to set

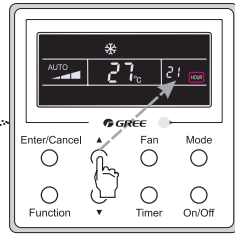

Press on to set the timer time.

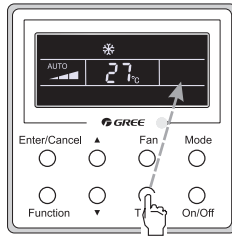

Press (Timer) button to cancel timer setting

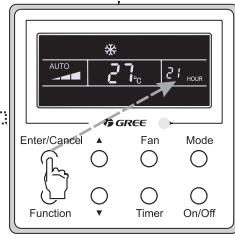



Press on Enter/Cancel to exit the timer mode.

Fig. 8 Setting Timer When Unit Is on

Timer range: 0.5 – 24hr. Each time ▲ or ▼ is pressed, the time setting increases or decreases by 0.5 hr. If either button is held down, the time setting will increase/ decrease by 0.5 hr every 0.5 sec.

### 3.6 Swing Setting

**Swing On:** With the unit on, press “Function” to activate the swing function. In this case,  will flash. Press Enter/Cancel to confirm.

**Swing Off:** When the Swing function is on, press “Function” to enter the Swing setting interface, with  flashing. Press Enter/Cancel to cancel this function.

How to set the Swing function is shown in Fig.9.

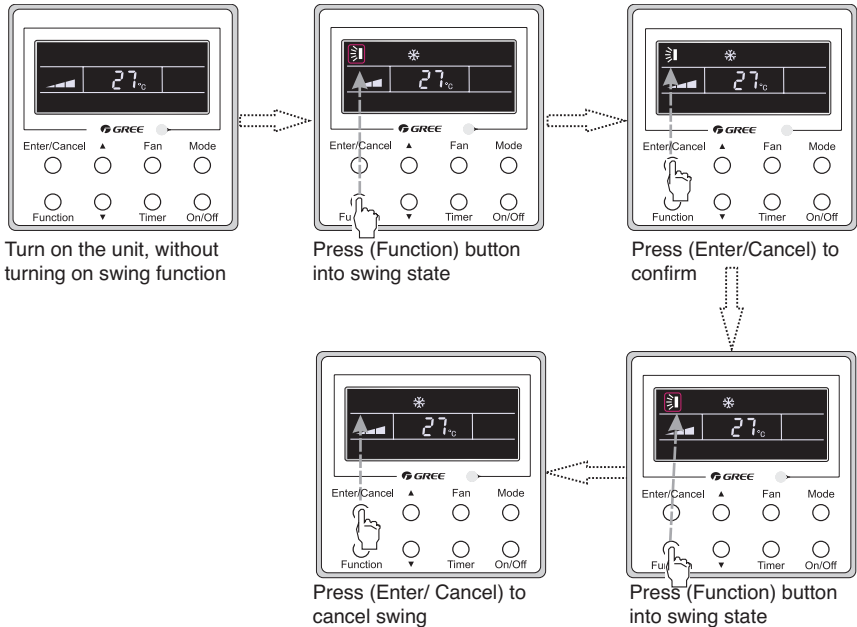

Fig. 9 Setting the Swing Function

**Note :**

- ① .Sleep, Turbo and Blow are set in the same way as setting the Swing function.
- ② .When Swing is set, press “Enter/Cancel” to go back to the setting status or the remote control will automatically go to the setting status after 5 sec.



### 3.7 Sleep Setting

**Sleep On:** With the unit on, press “Function” until you arrive at the Sleep setting interface. Press “Enter/Cancel” to confirm the setting.

**Sleep Off:** When the Sleep function is activated, press “Function” to enter the Sleep setting interface. Press “Enter/Cancel” to cancel.

When running in the Cool or Dry mode, the temperature will increase by 1°C when the unit has been in Sleep 1 for 1 hr and 1°C after another 1 hr. After that, the unit will continue to run at this temperature.

When running in the Heat mode, the temperature will decrease by 1°C when the unit has been in Sleep 1 for 1 hr and 1°C after another 1 hr. After that, the unit will continue to run at this temperature.

How to set the Sleep function is shown in Fig.10.

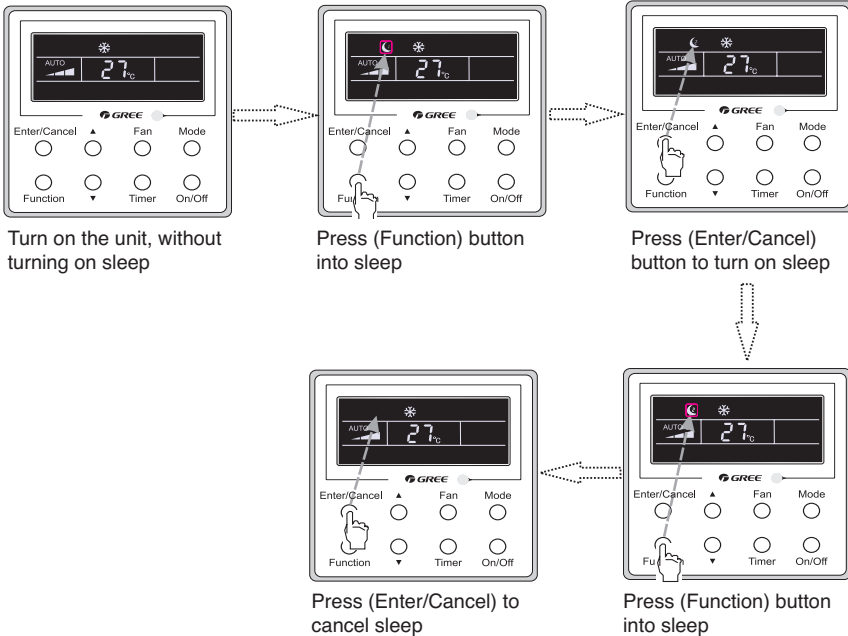

Fig. 10 Setting the Sleep Function

### 3.8 Turbo Setting

Turbo function: When the unit is set to High fan speed it will cool or heat more quickly, thus reaching the set temperature more quickly. When running in the Cool or Heat mode, press “Function” until you arrive at the Turbo setting interface. Press “Enter/Cancel” to confirm. When the Turbo function is activated, press “Function” to enter the Turbo setting interface. Press “Enter/Cancel” to cancel. How to set the Turbo function is shown in Fig.11.

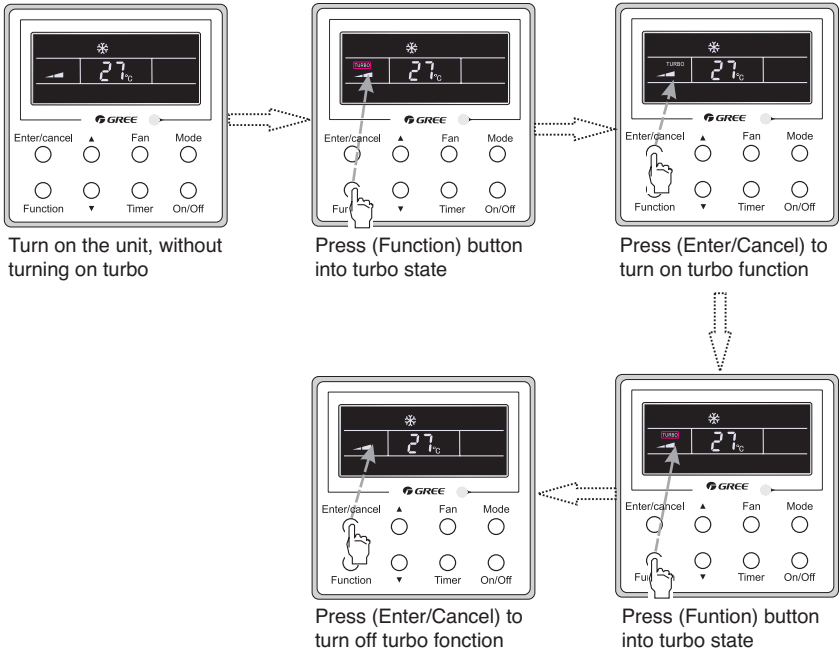

Fig.11 Setting the Turbo Function

### 3.9 E-heater Setting

E-heater (auxiliary electric heating function): When running in the Heat mode, the E-heater can be turned on to improve efficiency.

When the wired remote control or the remote control is set in the Heat mode, this function will turn on automatically.

When running in the Heat mode, press “Function” to enter the E-heater setting interface. Press “Enter/Cancel” to cancel this function.

If the E-heater function is not activated, press “Function” to enter the E-heater setting interface. Press “Enter/Cancel” to turn it on.

How to set this function is shown in Fig.12

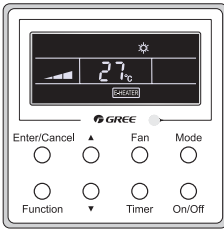

Auxiliary electric heating function is automatically on in Heating mode

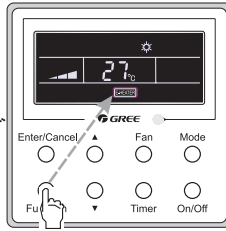

Press (Function) button into this function

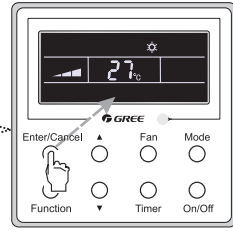

Press (Enter/Cancel) button to turn off this function

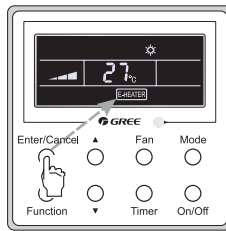

Press (Enter/Cancel) button to turn on this function

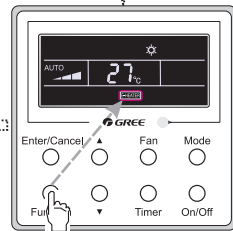

Press “Function” until E-heater

### 3.10 Blow Setting

Blow function: When the unit is turned off, the water in the indoor unit's evaporator automatically evaporates to prevent mildew.

When running in the Cool or Dry mode, press "Function" until reaching the Blow setting interface. Press "Enter/Cancel" to activate this function.

When the Blow function is activated, press "Function" until reaching the Blow setting interface. Press "Enter/Cancel" to cancel this function.

How to set the Blow function is shown in Fig.13.

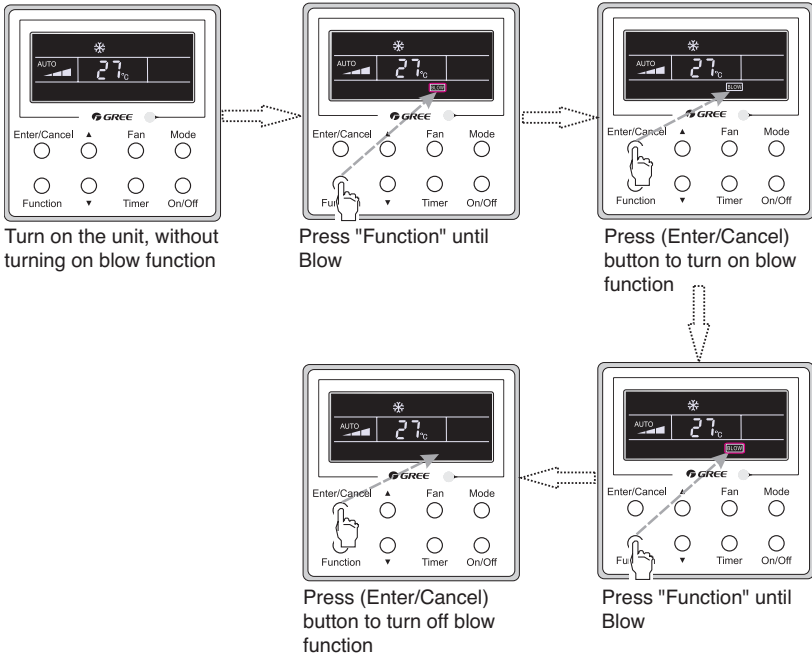



Fig.13 Setting the Blow Function

#### Notes :

- ① . When the Blow function is activated and the unit is turned off by pressing "On/Off" or with the remote control, the indoor fan will run at Low fan speed for 2 min., with "Blow" showing on the LCD screen. If the Blow function is deactivated, the indoor fan will turn off right away
- ② . The Blow function is not available in the Fan or Heat mode.

### 3.11 Other Functions

(1). Lock

When starting the unit , press ▲ and ▼ at the same time for 5 sec. until the wired remote control enters the Lock function. The LCD screen will display . Press these two buttons at the same time again for 5 sec. to unlock. When Lock is on, nothing will happen if a button is pressed.

(2) Memory

Memory switch: When the unit is off, press “Mode” and ▲ at the same time for 5 sec. to switch between Memory On and Memory Off. When this function is activated, Memory will be displayed. If this function is not set, the unit stays off after a power failure and power recovery.

Memory recovery: If this function has been set for the wired remote control, the wired remote control after power failure will resume its original running state upon power recovery. Memory contents: On/Off, Mode, set temperature, set fan speed and Lock function.

## 4 Installation and Disassembly

### 4.1

#### Connecting the Signal Line on the Wired Remote Control

- Open the cover of the indoor unit's electrical control box.
- Pass the signal line of the wired remote control through the rubber ring.
- Connect the signal line of the wired remote control to the 4-pin socket of the indoor unit's PCB.
- Tighten the signal wire with ties.
- The communication distance between the main board and the wired remote control can be up to 20 meters. (The standard distance is 8 meters.)

### 4.2 Installing the Wired Remote Control

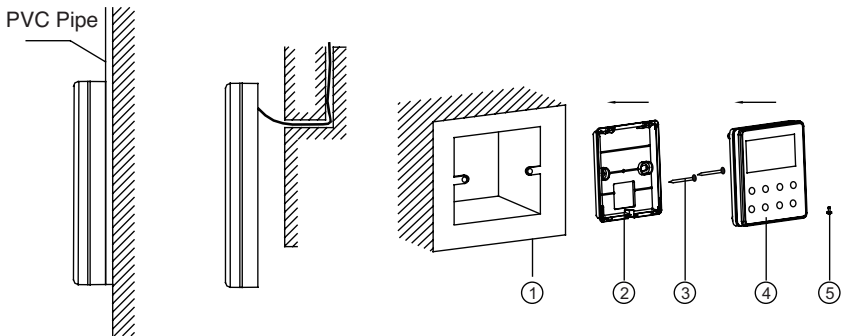

Fig. Accessories to Install the Wired Remote Control

Table 3

| No.  | 1                               | 2                                     | 3           | 4                                       | 5             |
|------|---------------------------------|---------------------------------------|-------------|---|---------------|
| Name | Socket box embedded in the wall | Soleplate of the Wired Remote Control | Screw M4X25 | Front Panel of the Wired Remote Control | Screw ST2.9X6 |

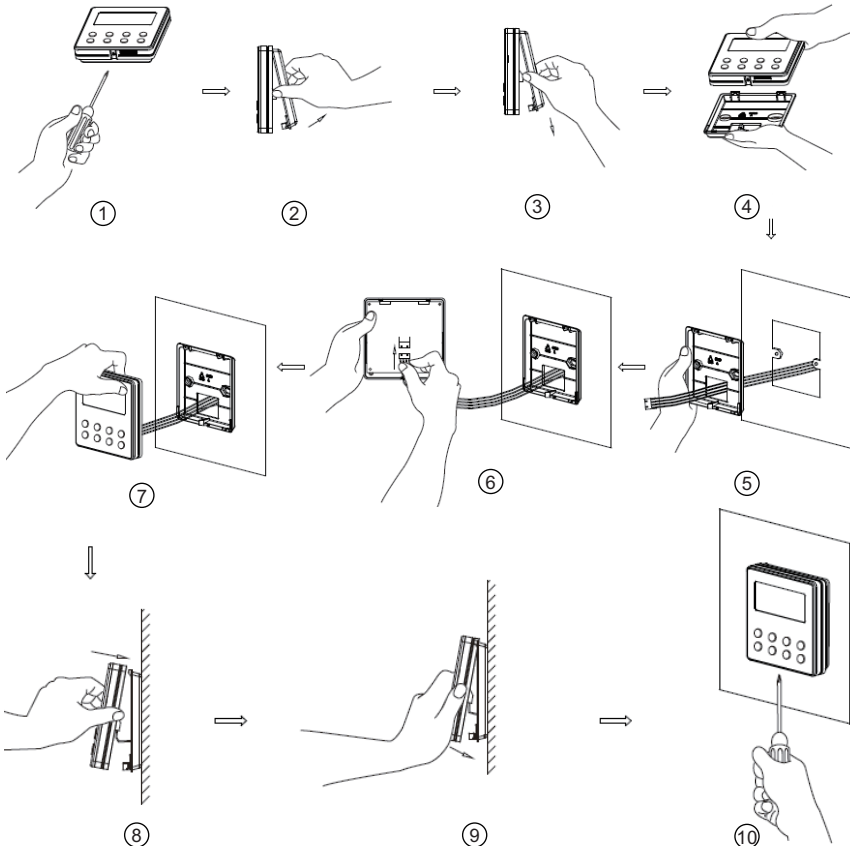

Fig. 15

Fig.15 shows the installation steps for the wired remote control, but the following elements must also be taken into account.

- (1) Prior to installation, first turn off the power supply, that is, do not use electricity during the entire installation.
- (2) Pull out the twisted four-core pair line from the installation holes and then pass it through the rectangular hole behind the soleplate on the wired remote control.
- (3) Attach the wired remote control soleplate to the wall over the installation hole and then affix it with M 4X25 screws.
- (4) Insert the twisted four-core pair line into the slot on the wired remote control and then buckle the front panel and the soleplate together.
- (5) Finally, attach the front panel and the soleplate of the wired remote control tightly with ST 2.9X6 screws.

**⚠ CAUTION!**

Pay special attention to the following during connection to prevent the air conditioner from malfunctioning due to electromagnetic interference.

- ① Separate the signal and communication lines of the wired remote control from the power wire and connection lines between the indoor and outdoor units, by a minimum interval of 20 cm, or the communication between the units will likely malfunction.
- ② If the air conditioning unit is installed where it is vulnerable to electromagnetic interference, then the signal and communication lines for the wired remote control must be shielding twisted pair lines.

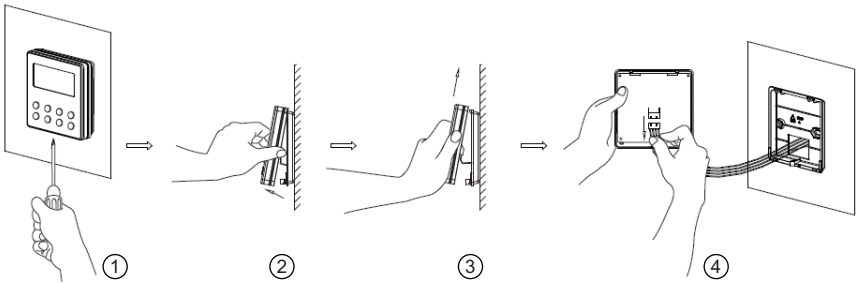
**4.3 Disassembling the Wired Remote Control****5 Errors Display**

If an error occurs when running the system, the error code will be displayed on the LCD screen, as shown in Fig.16. If multiple errors occur at the same time, their codes will be displayed in a sequence.

**Note:** In the event of an error, turn off the unit and contact a professional technician

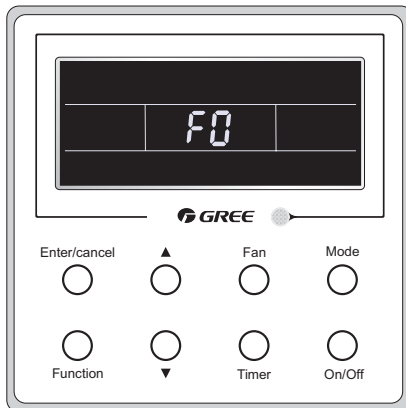

Fig. 16



**DEFINITION OF ERROR CODES**

|   |    |   |    |
|---|----|---|----|
| Return air temperature sensor open/short circuited                      | F1 | Drive board communication error                                 | P6 |
| Evaporator temperature sensor open/short circuited                      | F2 | Compressor overheating protection                               | H3 |
| Indoor unit liquid valve temperature sensor open/short circuited        | B5 | Indoor and outdoor units not matched                            | LP |
| Indoor gas valve temperature sensor open / short circuited              | B7 | Communication line misconnected or expansion valve error        | DN |
| IPM temperature sensor open/short circuited                             | P7 | Running mode conflict   | E7 |
| Outdoor ambient temperature sensor open/short circuited                 | F3 | Pump-down   | FO |
| Outdoor unit condenser mid-tube temperature sensor open/short circuited | F4 | Jumper Error  | C5 |
| Discharge temperature sensor open/short circuited                       | F5 | Forced defrosting   | H1 |
| Indoor-outdoor communication error                                      | E6 | Compressor startup failure                                      | LC |
| DC bus under-voltage protection   | PL | High discharge temperature protection                           | E4 |
| DC bus over-voltage protection  | PH | Overload protection   | E8 |
| Compressor phase current sensing circuit error                          | U1 | Whole unit over-current protection                              | E5 |
| Compressor demagnetization protection                                   | HE | Over phase current protection                                   | P5 |
| PFC protection  | HC | Compressor desynchronizing                                      | H7 |
| IPM temperature protection  | P8 | IPM current protection  | H5 |
| Over-power protection   | L9 | Compressor phase loss/reversal protection                       | LD |
| System charge short age or blockage protection                          | F0 | Frequency restricted/reduced with whole unit current protection | F8 |
| Capacitor charging error  | PU | Frequency restricted/reduced with IPM current protection        | EN |
| High pressure protection  | E1 | Frequency restricted/reduced with high discharge temperature    | F9 |
| Low pressure protection   | E3 | Frequency restricted/reduced with anti-freezing protection      | FH |
| Compressor stalling   | LE | Frequency restricted/reduced with overload protection           | F6 |
| Over-speeding   | LF | Frequency restricted/reduced with IPM temperature protection    | EU |
| Drive board temperature sensor error                                    | PF | Indoor unit water full  | E9 |
| AC contactor protection   | P9 | Anti-freezing protection  | E2 |
| Temperature drift protection  | PE | AC input voltage abnormal                                       | PP |
| Sensor connection protection  | PD | Whole unit current sensing circuit error                        | U5 |
| DC bus voltage drop error   | U3 | 4-way valve reversing error                                     | U7 |
| Outdoor fan 1 protection error  | L3 | Motor stalling  | H6 |
| Outdoor fan 2 protection error  | LA | PG motor zero-crossing protection                               | U8 |

