



Please read this owner's manual carefully before operating,
and keep it for reference.

A decorative scrollwork graphic in the bottom-left corner of the page, featuring intricate, swirling patterns.

BOARD HEATER / A/C

OWNER'S MANUAL

MODELS

GEH(09)AA-D3DNA1C/I

GEH(12)AA-D3DNA1C/I

GEH(18)AA-D3DNA1C/I

WWW.GREE.CA

St-Mathieu-de-Beloeil (Québec) Canada

1-866-680-GREE

00640-05/08/12

A decorative scrollwork graphic in the bottom-right corner of the page, mirroring the one in the top-left.

© Copyright, Sunrise Tradex Corp., 2012

CONTENTS

In accordance with the company's policy of continual product improvement, this appliance's aesthetic and dimensional characteristics, technical data and accessories may be changed without notice.

O P E R A T I N G I N S T R U C T I O N S	Parts and their functions1
	How to use the remote control2
	Maintenance6
	Operating guide8
	Precautions10
	Before contacting a service technician11
I N S T A L L A T I O N I N S T R U C T I O N S	Installing the indoor unit12
	Post-installation verification20
	Warranty22

Thank you for selecting a Gree product

By purchasing a room air conditioner, you not only get comfort, but also good health. These operating instructions present the various features your unit has to offer. In addition, they provide important maintenance and service information as well as tips to operate the unit more economically. Take a few minutes to discover how to achieve maximum comfort and save energy with your new room air conditioner.

The figures in this manual may differ from the actual objects. Please refer to the actual objects for reference.

This appliance is not intended for use by people (including children) with reduced physical, sensory or mental capabilities or lack of experience and knowledge unless they are closely supervised by the person responsible for their safety. Children should be supervised to ensure that they do not play with the appliance.

External static pressures of the appliance was tested at 0 Pa
Fuse link: T250 V; 3,15 A



Do not dispose of this product with unsorted municipal waste.
This product must be disposed of separately according to electronic waste regulations.

INDOOR UNIT

CAUTION

Before opening the front panel, be sure to turn the unit and the breaker off. Do not touch the metal parts inside the indoor unit, as this may result in injury.

1. Titanium apatite photocatalytic air-purifying filter:
 - These filters are attached to the inside of the air filters.
2. Air outlet
3. Display
4. Front panel
5. Louvers (vertical blades)
 - The louvers are inside of the air outlet.
6. Air intake
7. Air filter
8. Flap (horizontal blade)
9. Cool mode light
10. Heat mode light
11. Dry mode light
12. Run light
13. LED display screen
14. Indoor unit ON/OFF button:
 - Press once to start the unit. Press again to stop.
 - Refer to the table below for the AUTO temperatures.

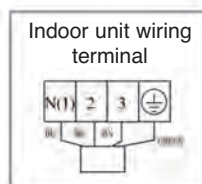
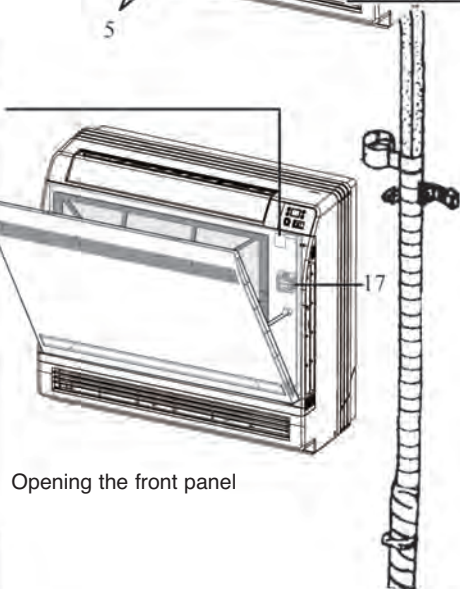
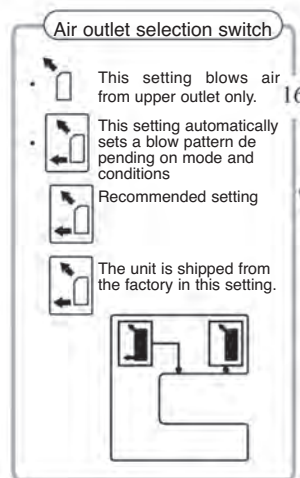
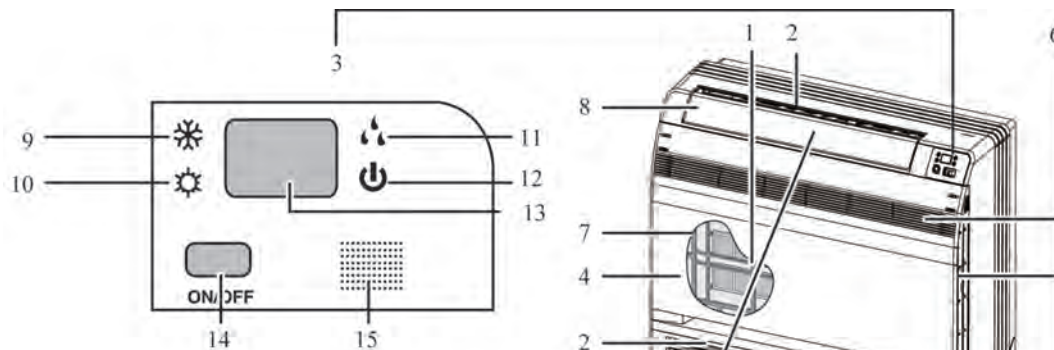

Model	Mode	Temperature setting	Air-flow rate
COOLING ONLY	COOL	25°C	AUTO
HEAT PUMP	AUTO	25°C	AUTO













- This button is useful when the remote control is missing.
15. Signal receiver:
 - Receives the signal from the remote control.
 - A short beep will sound when the unit has received a signal.
 - A beep will sound when the settings have been changed.
 16. Air outlet selection switch
 17. Room temperature sensor:
 - Detects the air temperature around the unit.

NOTE:

- 1 If the power cord is damaged, it must be replaced by the manufacturer, its service agent or a similarly qualified technician in order to avoid a hazard.
- 2 The appliance must be installed in accordance with national wiring regulations.
- 3 An all-pole disconnection switch having a contact separation of at least 3mm in all poles should be connected in the fixed wiring.

• Remote control description



- 1 ON/OFF** 
Press to start or stop the unit.
- 2 -** : Press to decrease the temperature setting.
- 3 +** : Press to increase the temperature setting.
- 4 MODE** 
Press to select the running mode (AUTO/COOL/DRY/FAN/HEAT/).
- 5 FAN** 
Press to set the fan speed.
- 6 SWING** 
Press to set the swing angle of the louvers.
- 7 I FEEL** 
- 8** 
Press to set the OUTSIDE or RECYCLED AIR function.
- 9 SLEEP** 
- 10 TEMP** 
- 11 QUIET** 
Press to set the QUIET function.
- 12 CLOCK** 
Press to set the clock.
- 13 T-ON/T-OFF**
Press to set the auto-off/auto-on timer.
- 14 TURBO** 
- 15 LIGHT** 
Press to turn the light on/off.
- 16 X-FAN** 

• Remote control description

1 **ON/OFF**

Press this button to turn the unit on. Press again to turn the unit off.

2 **-** :

Press this button to decrease the set temperature. Hold it down for longer than two seconds to decrease the set temperature at a faster rate. The set temperature is not adjustable in AUTO mode.

3 **+** :

Press this button to increase the set temperature. Hold it down for longer than two seconds to increase the set temperature at a faster rate. The set temperature is not adjustable in AUTO mode.

4 **MODE**

Press this button to select a mode from a sequence of AUTO, COOL, DRY, FAN, and HEAT *, as follows:





AUTO ► COOL ► DRY ► FAN ► HEAT*

*Note: Only for models with the heating function

AUTO is the default mode when the unit is started. When in AUTO mode, the set temperature will not be displayed on the unit's LED screen, and the unit will automatically select the suitable running mode based on the room temperature.

5 **FAN**

Press this button to select the Fan Speed from a sequence of AUTO, ,

, ,  to  then back to Auto.:

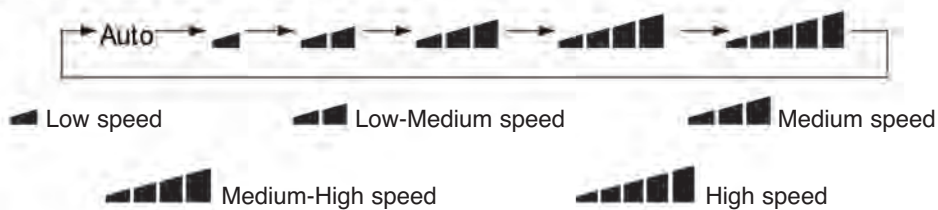





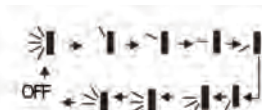

6 **SWING**

Press this button to set the swing angle of the louvers, which changes in a sequence as below:







This is a universal remote control. If the ,  or  positions are chosen, the unit will carry out the command as 

 indicates the guide louver swings in this sequence     



7 **I FEEL**

Press this button to activate the I FEEL function. The unit will automatically adjust the temperature according to the detected room temperature. Press this button again to cancel the I FEEL function.

8

Press this button to select either outside or recycled air. Press once for the recycled air mode, and the LCD screen displays “”. Press a second time to use set both the recycled and outside air modes, and the LCD screen displays “” and “”. Press a third time to stop the simultaneous outside and recycled air mode. Press a fourth time to run in the outside air mode, and the LCD screen displays “”. Press the button again to repeat the above operation.



9 SLEEP

- Press this button to select Sleep 1 () , Sleep 2 () , Sleep 3 () and cancel Sleep, from the sequence. Sleep Cancel is the default setting when the unit is turned on.
- Sleep 1 is Sleep mode 1. In Cool or Dehumidify mode: after running for one hour in Sleep, the main unit's temperature setting will increase 1°C. After running for two hours in Sleep, the temperature setting will increase 2°C, and the unit will continue running at this temperature. In Heat mode: after running for one hour in Sleep, the temperature setting will decrease 1°C. After running for two hours, the temperature setting will decrease 2°C, and the unit will continue running at this temperature.
- Sleep 2 is sleep mode 2. The air conditioner will run based on a preset temperature curve.
- Sleep 3- Set your own temperature curve for the Sleep mode:
 - (1) In Sleep 3 mode, press the "Turbo" button for several seconds; the remote control will show the user customization sleep setting status. The time on the remote control will be "1 hour" and the flashing set temperature "88" will be the last temperature in the sleep-mode temperature curve. (The first displays you see are the initial factory settings.);
 - (2) Press "+" or "-" to change the temperature settings. Once selected, press "Turbo" to confirm;
 - (3) The remote control display will automatically move to the next hour setting (2 hours, 3 hours or 8 hours). The flashing set temperature "88" will display the last temperature setting in the sleep-mode temperature curve;
 - (4) Repeat step (2) to (3) until the "8 hour" temperature setting has been entered and the temperature curve is set. The remote control will return to the "1 hour" display and the temperature display will return to the first set temperature.
- Sleep 3- It is possible to verify the temperature curve settings in the user-set SLEEP mode.
- The user can verify the temperature curve settings without changing the temperatures by simply pressing the "Turbo" button to confirm the temperature and go to the next one. Note: When setting or verifying the temperature curve, if no button is pressed within 10 seconds, the setting mode will automatically turn off and the originally set temperatures will remain. Also, if "ON/OFF," "Mode," "Timer," or "Sleep" are pressed when setting or verifying the temperature curve for the sleep mode, the setting mode will automatically turn off.

10 TEMP

Press this button to set the indoor temperature setting or the indoor ambient temperature. When the indoor unit is first turned on, it will display the set temperature. If the temperature display is changed to “”, the ambient temperature will be displayed. Either five seconds later or if it receives a remote control signal within five seconds, the set temperature will again be displayed. If the temperature display has not been set, the temperature will be displayed.

11 QUIET

Press this button to set the Quiet status to Auto Quiet mode (displays “” and "Auto" signal), Quiet mode (displays “” signal) or Quiet OFF (no display). When first turned on, Quiet OFF is the default setting. Note: The Quiet function cannot be used when running in the Fan or Dry mode. The fan speed is not available in Quiet mode (“”),.

12 CLOCK

Press the CLOCK button and the “” will flash. Within 5 seconds, press + or - to set the time. Hold down either of those buttons for two seconds or longer to increase or decrease the time by 1 minute every 0.5 second and then by 10 minutes every 0.5 second. After setting the time and while it is flashing, press the CLOCK button again to confirm the set time.

13 T-ON|T-OFF



Press T-ON to turn on the auto-ON timer. To cancel the auto-timer program, simply press this button again. After pressing this button, “” disappears and a flashing "ON" appears. The ON time can be set when 00:00 is displayed. Within 5 seconds, press + or - to set the time. Each time the + or - buttons are pressed, the time setting changes by 1 minute. Hold down either button to change the time by 10 minute intervals. Within 5 seconds of setting the time, press TIMER ON to confirm.

Press T-OFF to turn on the auto-off timer. To cancel the auto-timer program, simply press the button again. Set the TIMER OFF in the same manner as the TIMER ON.

14 TURBO

Press this button to activate/deactivate the Turbo function, which enables the unit to reach the preset temperature in the shortest time. In COOL mode, the unit will blow cool air at super-high fan speed. In HEAT mode, the unit will blow warm air at super-high fan speed.

15 LIGHT



Press LIGHT to turn on the display light and press again to turn it off. If the light is turned on, "  " is displayed. If the light is turned off, "  " disappears.

16 X-FAN

If X-FAN is pressed when the unit is in COOL or DRY mode, the icon  will be displayed and the indoor fan will continue running for 10 minutes in order to dry the indoor unit, even if the unit has been turned off.

When the unit is turned on, X-FAN OFF is the default setting. X-FAN is not available in the AUTO, FAN or HEAT modes.

17 Combination of "+" and "-" buttons: Lock

Press "+" and "-" buttons at the same time to lock or unlock the keypad. If the remote control is locked, "  " is displayed. In this case, when any button is pressed, "  " blinks three times.

18 Combination of "MODE" and "-" buttons: Switch between Fahrenheit and Celsius

When the unit is OFF, press "MODE" and "-" at the same time to switch between °C and °F.

19 Combination of "TEMP" and "CLOCK" buttons: Energy-saving function

When the unit is running in the COOL mode, press "TEMP" and "CLOCK" simultaneously to start energy-saving function. The remote control displays "SE". Repeat the operation to cancel the function.

20 Combination of "TEMP" and "CLOCK" buttons: 8°C heating function

When the unit is running in the HEAT mode, press "TEMP" and "CLOCK" simultaneously to start the 8°C heating function. The remote control displays "  " and a selected temperature of "8°C". (46°F if Fahrenheit is chosen).

Repeat the operation to cancel the function.

21 About the back-lighting function

When first turned on, the unit lights turn on for four seconds. They turn on for three seconds when pressed again.

Replacing the Batteries

1. Remove the battery cover plate from the back of the remote control.
(As shown in the figure)
2. Take out the old batteries.
3. Insert two new AAA1.5V dry batteries, paying attention to the polarity.
4. Reattach the battery cover plate.

Notes:

- When replacing the batteries, do not use old batteries or different types of batteries, which may cause a malfunction.
- If the remote control will not be used for an extended period of time, remove the batteries to prevent leakage.
- Use the remote control within its receiving range.
- The remote control should be kept 1 m away from a TV or stereo.
- If the remote control malfunctions, remove the batteries, wait 30 seconds and then reinsert them. If there is still a problem, replace the batteries.

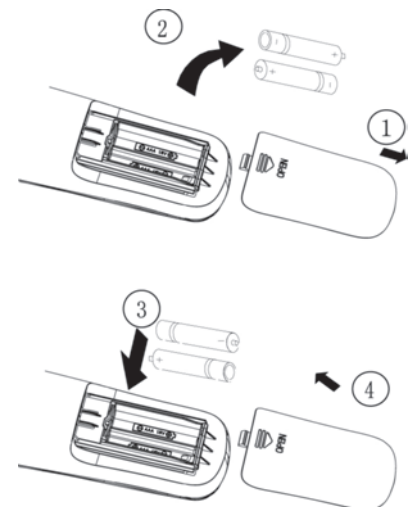

Before inspecting and cleaning the unit, PLEASE turn the unit OFF and turn off the power supply.

3.1 Units

- Indoor unit, outdoor unit and remote control

1. Wipe with a soft, dry cloth.

- Front panel

1. Open the front panel.

Slide the two stoppers on the left and right sides inward until they click.

2. Remove the front panel.

- Remove the string.

- Allow the front panel to fall forward and remove it.

3. Clean the front panel.

- Wipe with a soft, wet cloth.

- Use only gentle detergents.

- After washing the front panel with water, dry it with cloth and place it in the shade to dry completely.

4. Reattach the front panel.

- Insert the front panel into the grooves of the unit (3 places).

- Attach the string to the right, inner-side of the front grill.

- Close the panel slowly.

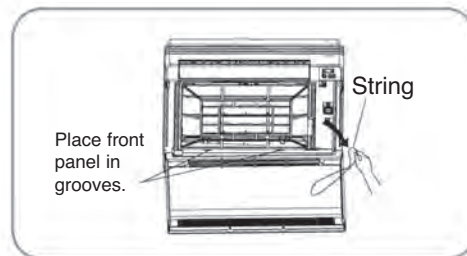
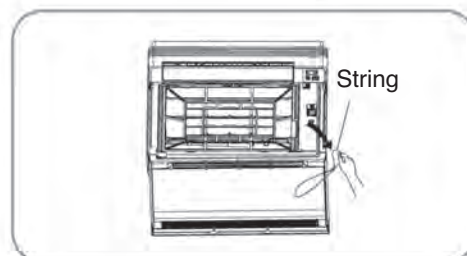
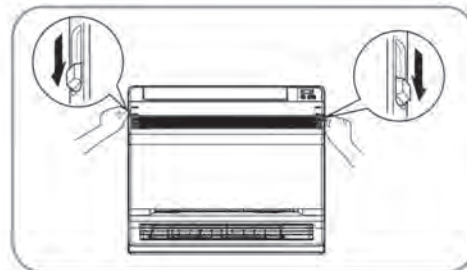

CAUTION

- Do not touch the metal parts of the indoor unit, as they may cause an injury.
- When removing or attaching the front panel, use a sturdy and stable stool and place your feet carefully.
- When removing or attaching the front panel, support the panel securely with hand to prevent it from falling.
- For cleaning, do not use water above 40°C, benzene, gasoline, paint thinner or other volatile oils, polishing compound, scrubbing brushes or other rough cleaners.
- After cleaning, make sure that the front panel is securely attached.

3.2 Filters

1. Open the front panel.

2. Remove the air filter.

- Press the claws on the right and left of the air filter down slightly, then pull upward.

3. Take off the titanium apatite photocatalytic air-purifying filter.

- Hold the tabs of the frame, and remove the claws in four places.



4. Clean or replace each filter.
See figure.
5. Wash the air filters with water or clean them with vacuum cleaner.
 - If the dust does not come off easily, wash them with a gentle detergent and luke warm water, then dry them in the shade.
 - It is recommended to clean the air filters every week.
6. Replace the air filter and the titanium apatite photocatalytic air-purifying filter and close the front panel.
 - Running the unit without air filters may be problematic as dust will accumulate inside the unit.

3.3 Titanium apatite photocatalytic air-purifying filter

The titanium apatite photocatalytic air-purifying filter can be washed with water once every six months. We recommend replacing it every three years.

- Maintenance
 1. Vacuum dust and soak in warm water for about 10 to 15 minutes if very dirty.
 2. Do not remove filter from frame when washing with water.
 3. After washing, shake off remaining water and dry in the shade.
 4. Since the material is made out of paper, do not wring out the filter when removing water from it.
- Replacement
 - Remove the tabs on the filter frame and replace with a new filter.
 - Dispose of the old filter as flammable waste.

NOTE

- Running the unit with dirty filters:
 - (1) does not remove odours.
 - (2) results in poor heating or cooling.
 - (3) does not clean the air.
 - (4) may cause odour.

CHECK

Check that the base, stand and other fittings of the outdoor unit are not decayed or corroded.
Check that nothing is blocking the air intakes and outlets of the indoor unit and the outdoor unit.
Check that the drainage water flows out of the drain hose during COOL or DRY operation. <ul style="list-style-type: none"> • If no drain water is seen, water may be leaking from the indoor unit. Turn the unit off and consult the service centre.

3.4 Before a long idle period

1. Operate the "FAN only" for several hours on a dry day to dry out the inside.
 - Press "MODE" and select "FAN".
 - Press "ON/OFF" to turn on.
2. After the unit is turned off, turn off the breaker for the air conditioner.
3. Clean the air filters and replace them.
4. Remove the batteries from the remote control.

NOTE

- When a multi-outdoor unit is connected, make sure the heating mode is not in use in the other room before you turn the fan on.

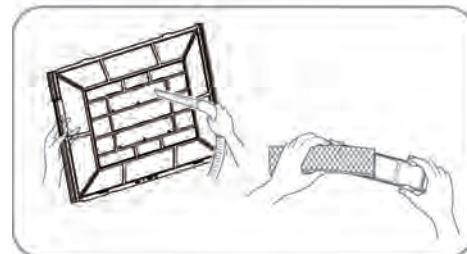
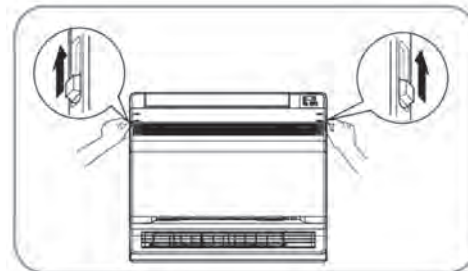
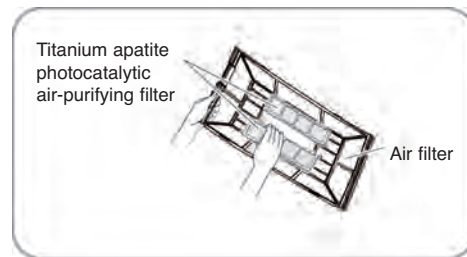

Working principle and special functions for cooling

Principle:

The air conditioner absorbs heat in the room and releases it outdoors, so that the indoor ambient temperature decreases. Its cooling capacity increases or decrease depending on the outdoor temperature.

Defrost function:

If the unit is running in COOL mode and at a low temperature, frost may form on the heat exchanger. When the indoor heat exchange temperature goes below 0oC, the indoor unit's microcomputer will stop the compressor to protect the unit.

Working principle and special functions for heating

Principle:

- * The air conditioner absorbs heat from the outdoors and transmits it indoors to raise the room temperature. This is the heat-pump heating principle: the heating capacity will be reduced if the outdoor temperature decreases.
- * If outdoor temperature is extremely low, please operate along with other heating appliances.

Defrosting:

- * When the outdoor temperature is low but the humidity is high and the unit has been running for some time, frost will form on the outdoor unit, affecting the heating capacity. In this case, the auto-defrost function will turn on and the heat will stop for 8-10 mins.
- * During auto-defrost, the fan motors of the indoor and outdoor units will stop.
- * While defrosting, the indoor indicator flashes (or displays "H1"). The outdoor unit may emit vapor, which is caused by the defrosting and is not a malfunction.
- * When the defrosting is complete, the heat will restart automatically.

Anti-cool wind function:

When running in the Heat mode and there is one of the following three statuses, the indoor fan motor may not start in order to prevent blowing cool air into the room (within 3 mins):

1. Heat mode just started.
2. After auto-defrost is finished.
3. Heating under low temperature.

The climate type of this unit can be found on the nameplate.

- The temperature should not be set lower than what you need. This will lead to increased energy costs

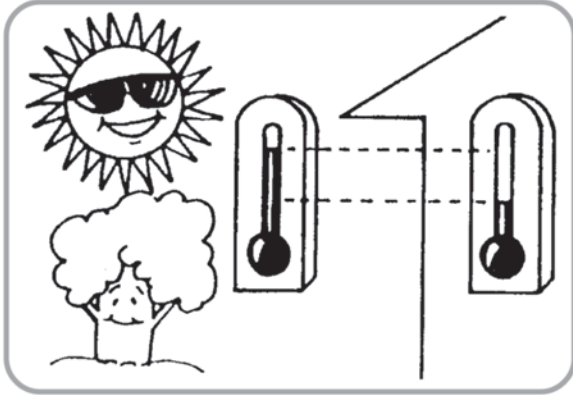

- To distribute cool air throughout the room, adjust the air flow direction as shown by the arrows (see picture).

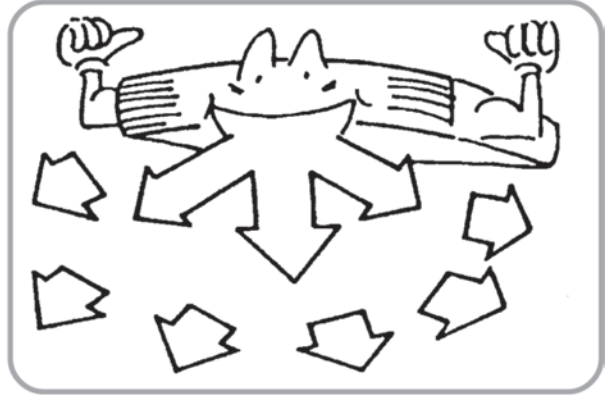

- Clean the air filter every week for greater efficiency

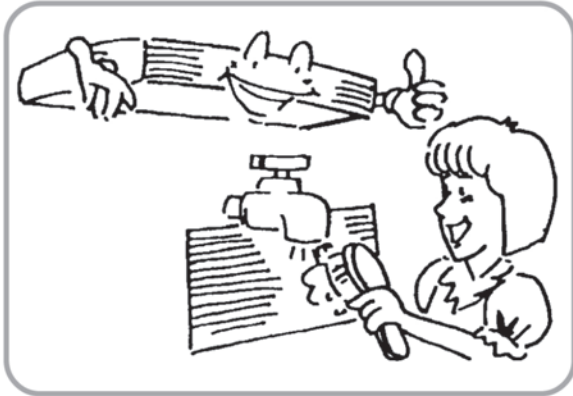

- Close windows and doors while running the unit to prevent leakage of cool air and to save energy.

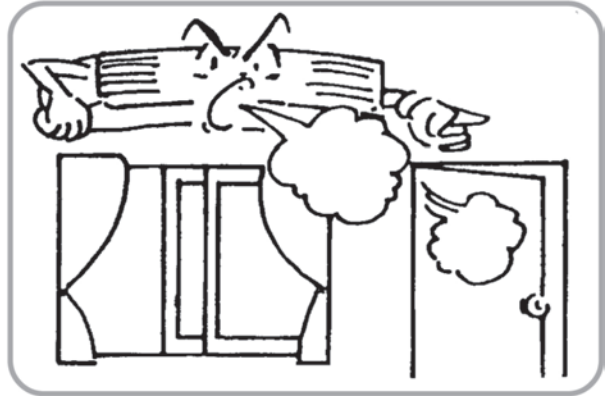

- Close curtains or glass windows when cooling to prevent heat from sunlight, which may increase electricity costs.



- In case of ineffective ventilation, open a window to ventilate the room once in a while. Do not leave it open too long since cool air will escape.

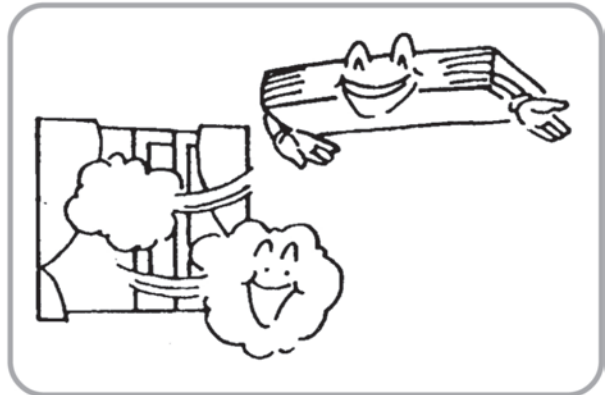

- Check the electrical system (voltage and frequency). Use the proper power supply indicated on the unit to operate the air conditioner. Only use fuses with the specified capacity. Do not use pieces of wire instead of fuses.



- If electrical interference occurs while running the unit, turn the air conditioner off. If the unit will not be used for a long time, turn off the power supply.



- Do not insert objects into the air intake or outlet when the air conditioner is running, as it may cause damage or personal injury. Also pay close attention when children are nearby

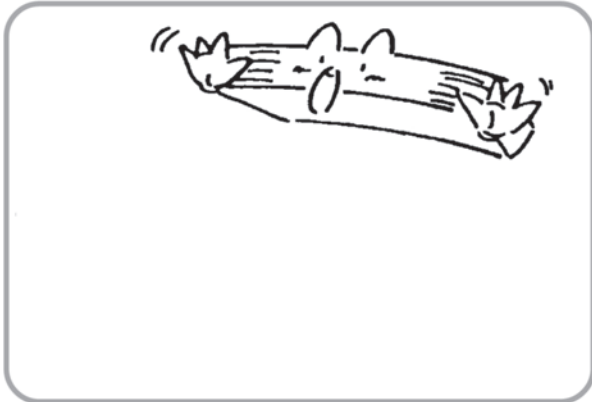

- Do not place any object in the air flow of indoor and outdoor unit as it may cause inefficient performance or malfunction.

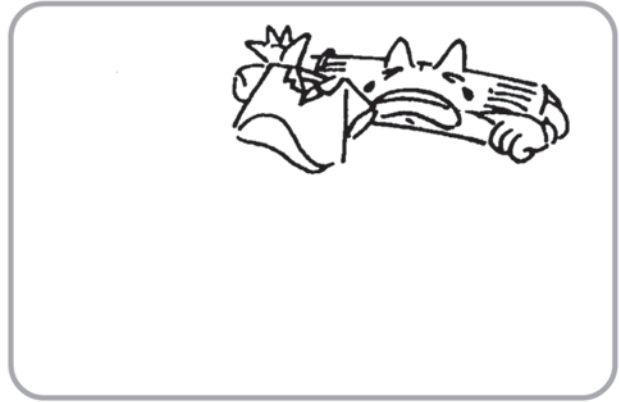

- Do not allow the air to flow directly at people, especially infants, the elderly or the sick.



- Do not place a heater or other heat source near to the unit. The heat may deform plastic parts.



6 Before contacting a service technician

Check the following before contacting a service technician. You may find the solution to your problem here.
If the unit still does not function properly after checking this list, please contact your local dealer.

PROBLEM	CAUSES
Not running	Check if electrical wire is damaged and if breaker switch is on. Check if the power supply is correct. Check if the timer switch is on or not.
The air conditioner runs but does not cool enough	Check if the preset temperature is too high. Check if sunlight is shining directly into the room. Check if the doors and windows are open. Check if there is anything obstructing the air discharge. Check if the exhaust fan is working. Check if the air filter is dirty or clogged.
Vapour or mist coming out of the unit while running.	Hot air in the room mixes with cool air. This causes mist.
Remote control not working	Loose or disconnected wire between the unit and the display. Check if the batteries are inserted in correct direction. Check if the batteries are empty.

SELECTION OF LOCATION

- Where cool air can be distributed throughout the room.
- Where condensate water is easily drained out.
- That can handle the weight of indoor unit.
- Easy access for maintenance.
- The appliance must not be installed in a laundry room.

THERE ARE 2 TYPES OF INSTALLATION.

- CEILING
- FLOOR

Each type is similar to the other as follows;

Indoor unit

The indoor unit should be installed in a place where:

- 1) the installation restrictions specified in the indoor unit installation drawings are met.
- 2) both air intake and exhaust have clear paths.
- 3) the unit is not in direct sunlight.
- 4) the unit is placed away from the heat sources or steam.
- 5) there is no source of machine oil vapour (this may shorten indoor unit life).
- 6) cool (warm) air is circulated throughout the room.
- 7) the unit is placed away from electronic ignition type fluorescent lamps (inverter or quick-start type) as they may shorten the remote control range.
- 8) the unit is at least 1 metre away from any television or radio (unit may cause interference with the picture or sound).

CAUTION: DO NOT INSTALL IN AREAS WHERE PROBLEMS ARE LIKELY TO OCCUR.

- Where there is a large amount of oil.
- Where there is an acid base.
- Where there is an irregular electrical supply.

Indoor Unit Installation Drawings

The indoor unit may be mounted in any of the three ways shown here.

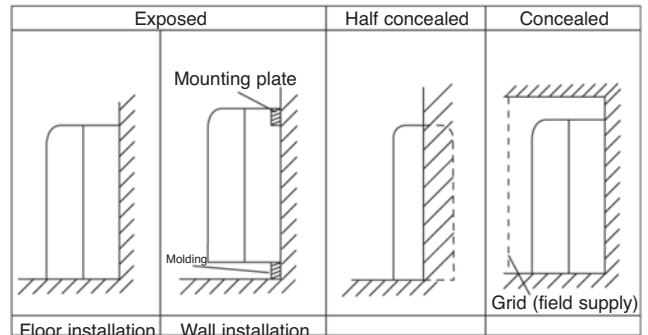

Location for securing the installation panel

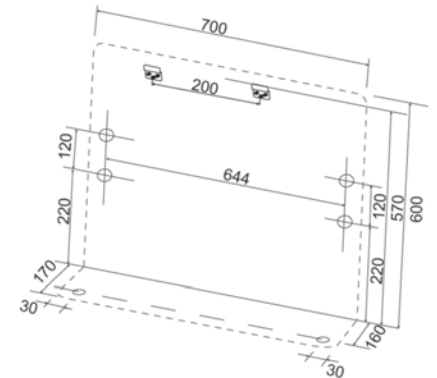

Schematic drawing of hooks:

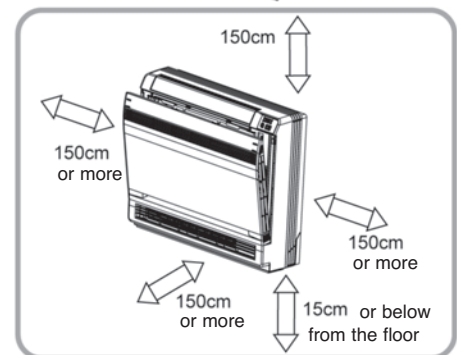
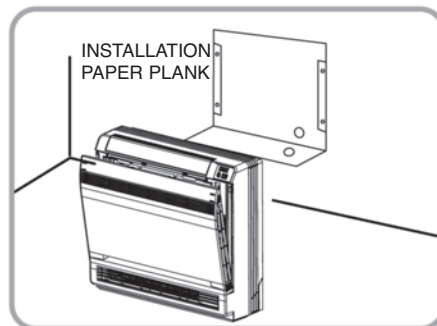
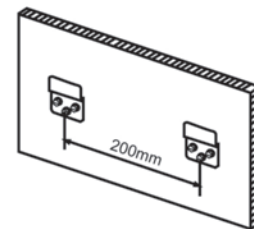

Refrigerant piping

- 1) Drill a hole (55 mm in diameter) in the spot indicated by the  symbol in the illustration below .
- 2) The location of the hole will differ depending on which side of the pipe will be coming out.
- 3) For piping, see Connecting the refrigerant pipe, under Installing the Indoor Unit (1).
- 4) Allow space around the pipe for an easier indoor unit pipe connection.

(Unit: mm)

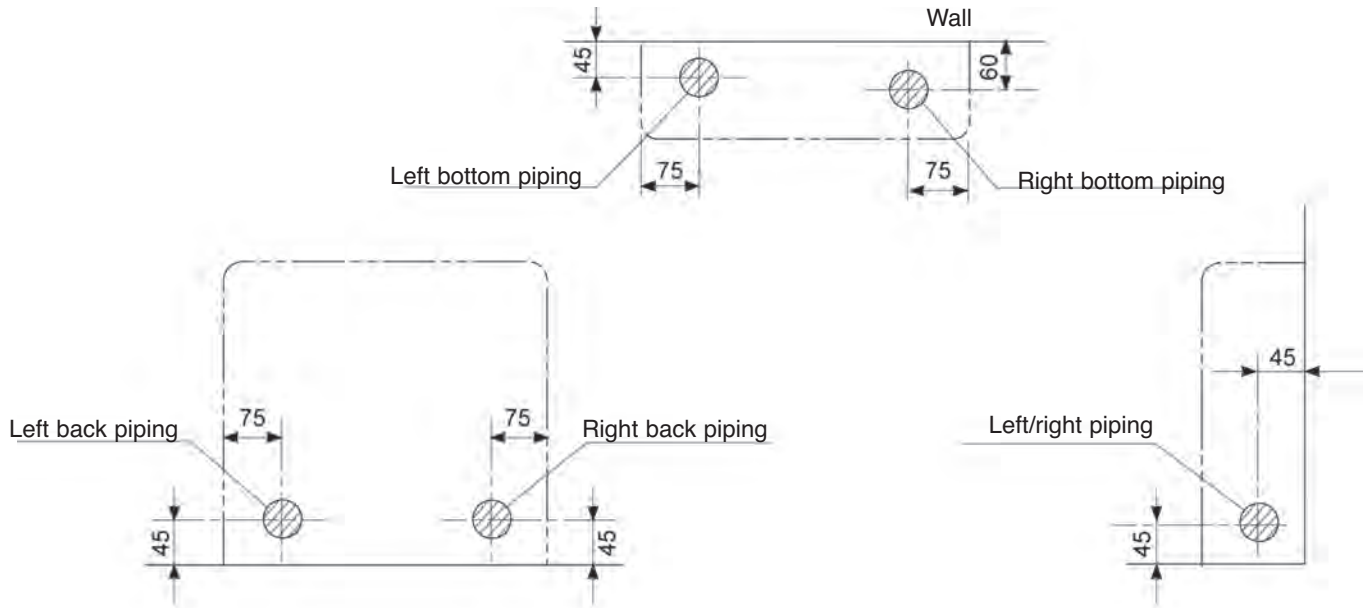

CAUTION

Min. allowable length

- The suggested shortest pipe length is 2.5 m in order to avoid noise from the outdoor unit and vibration. (Mechanical noise and vibration may occur depending on how the unit is installed and the environment in which it is used.)
- See the installation manual for the outdoor unit for the maximum pipe length.

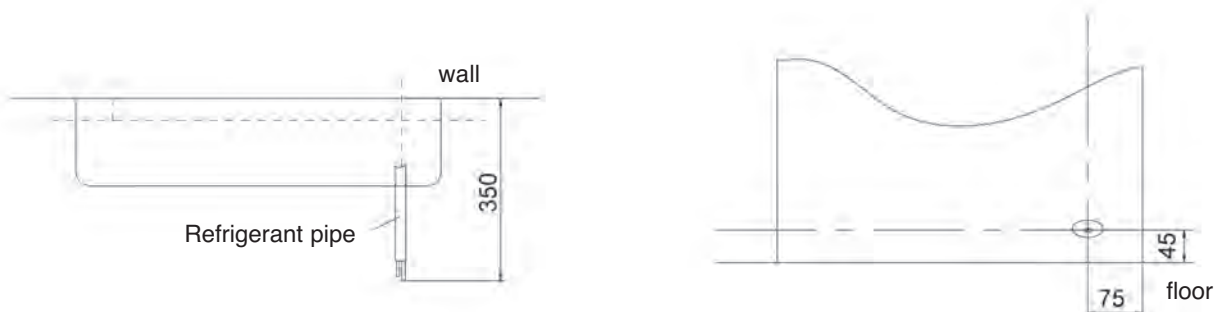

Boring a wall hole and installing the pipe into a wall

- For walls containing metal frame or metal panels, be sure to use a wall embedded pipe and wall cover in the feed-through hole to prevent water leakage.
 - Be sure to caulk the gaps around the pipes with caulking material to prevent water leakage.
- 1) Bore a feed-through hole of 55 mm in the wall so it slopes downward toward the outside.
 - 2) Insert a wall pipe into the hole.
 - 3) Insert a wall cover into wall pipe.
 - 4) After completing refrigerant piping, wiring and drain piping, caulk pipe-hole gap with putty.

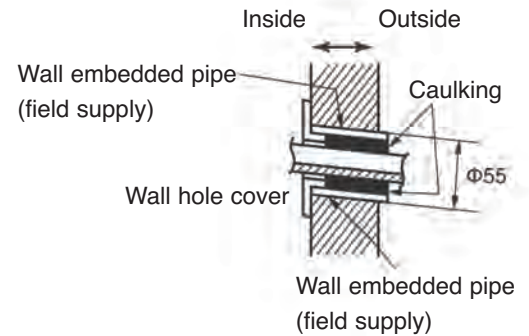

Drain piping

- 1) Use commercial rigid polyvinyl chloride pipe (general VP 20 pipe, outer diameter 26mm, inner diameter 20mm) for the drain pipe.
- 2) The drain hose (outer diameter 18 mm at connecting end, 220 mm long) is supplied with the indoor unit. Position the drain pipe as in the picture below.
- 3) The drain pipe should be at a downward incline so that water will flow smoothly without any accumulation. (Should not be trap.)
- 4) Insert the drain hose to this depth so it will not be pulled out of the drain pipe.
- 5) Insulate the indoor drain pipe with 10 mm or more of insulation material to prevent condensation.
- 6) Remove the air filters and pour some water into the drain pan to check whether the water flows smoothly.

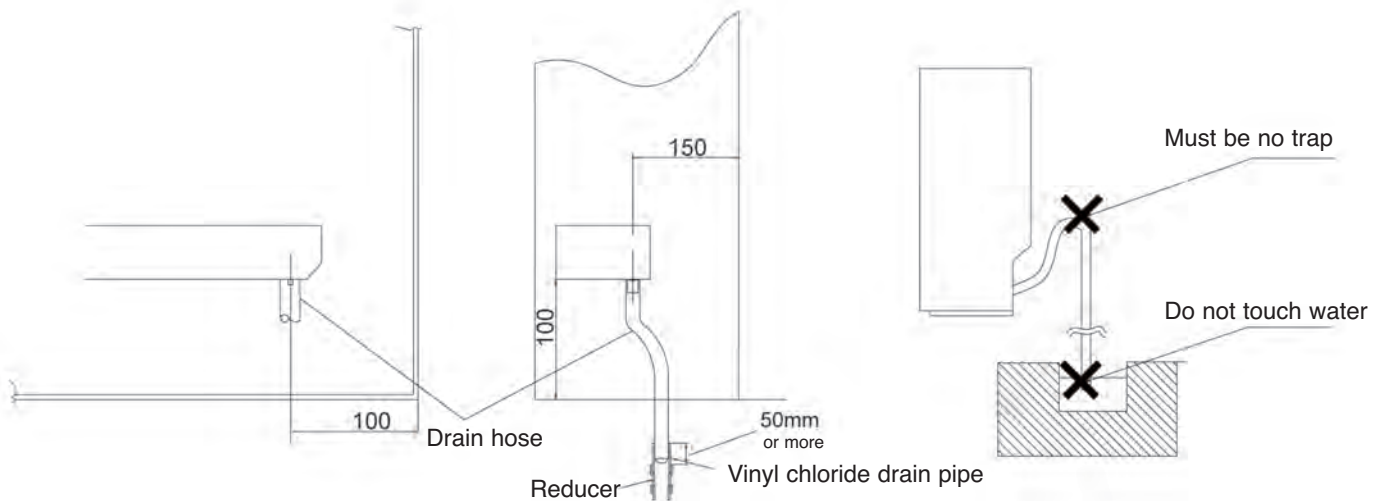

Installing indoor unit

1. Preparation

- Open the front panel, remove the four screws and remove the front grill by pulling it forward.
- Follow the arrows to disengage the clasps on the front case to remove it.
- Follow the procedure below when removing the slit portions.

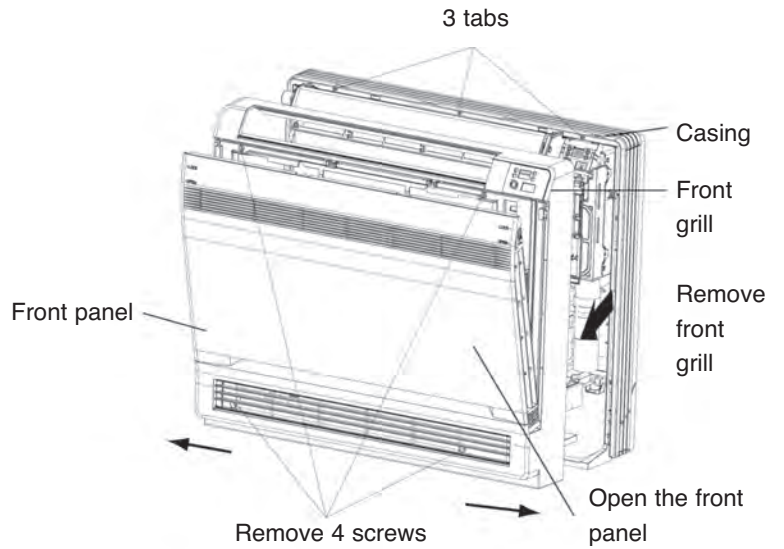

For mouldings

- Remove the pillars. (Remove the slit portions on the bottom frame using nippers.)

For side piping

- Remove the pillars.
 - 1) Remove the seven screws.
 - 2) Remove the upper casing (2 tabs).
 - 3) Remove the left and right casings (2 tabs on each side).
 - 4) Remove the slit portions on the bottom frame and casings using nippers.
 - 5) Replace by following the steps in reverse order (3> 2> 1).

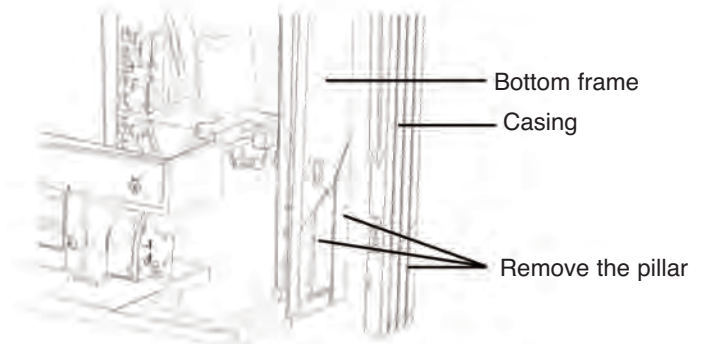
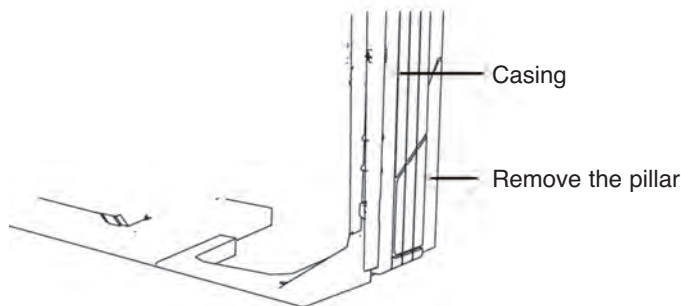
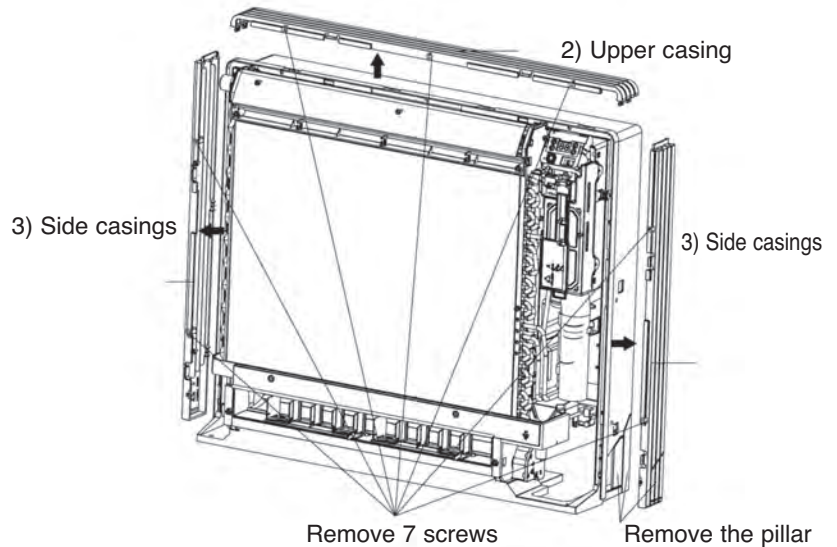

2. Installation

- Secure using six screws for floor installations. (Do not forget to secure to the rear wall.)
- For wall installations, secure the mounting plate using five screws and the indoor unit using four screws.

The mounting plate should be installed on a wall that can support the weight of the indoor unit.

- 1) Temporarily secure the mounting plate to the wall, make sure that the panel is completely level, and mark the boring points on the wall.
- 2) Secure the mounting plate to the wall with screws.

Floor Installation

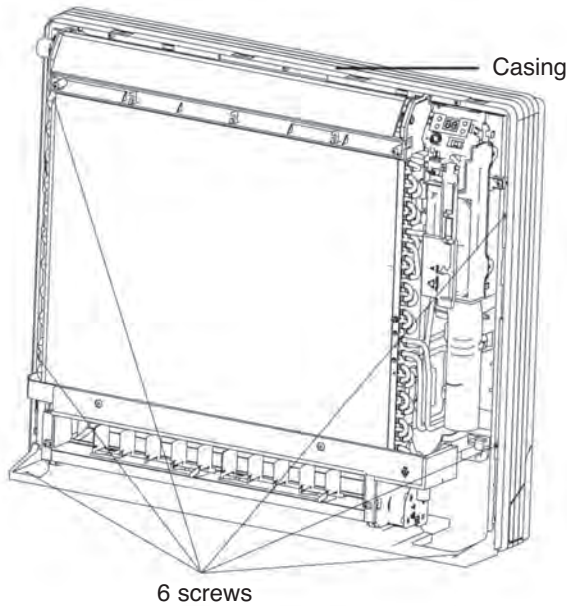

Wall Installation

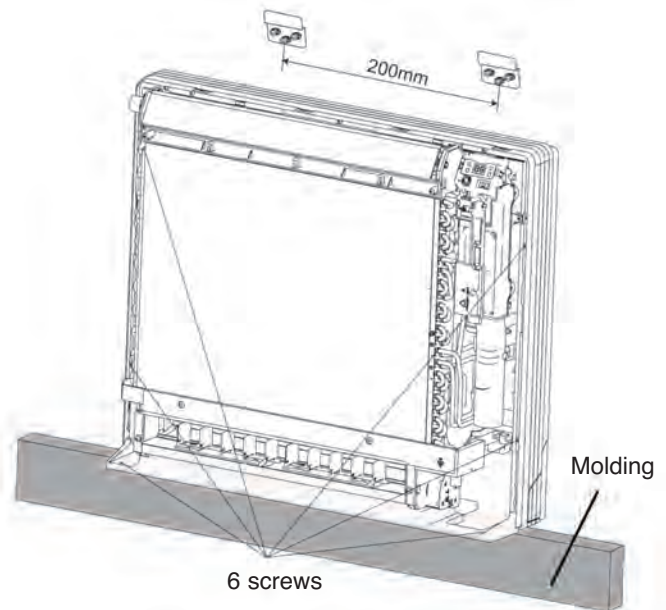

- 3) Once refrigerant piping and drain piping connections are complete, fill in the gap of the through-hole with putty. A gap can lead to condensation on the refrigerant pipe and drain pipe, and allows insects into the pipes.
- 4) Attach the front panel and front grill in their original positions once all connections are complete.

Flaring the pipe end

- 1) Cut the pipe end with a pipe cutter.
- 2) Remove burrs with the cut surface facing downward so that the chips do not enter the pipe.
- 3) Fit the flare nut on the pipe.
- 4) Flare the pipe.
- 5) Check that the flaring is done properly.

WARNING

- 1) DO not use mineral oil on flared part.
- 2) Prevent mineral oil from getting into the system as this would reduce the lifetime of the units.
- 3) Never use piping which had been used for previous installations. Only use parts which are delivered with the unit.
- 4) Never install a drier to this R410A unit in order to guarantee its lifetime.
- 5) The drying material may dissolve and damage the system.
- 6) Incomplete flaring may cause refrigerant gas leakage.

Flaring

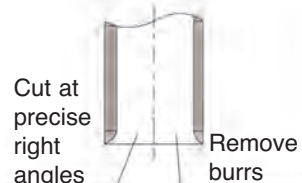

Set exactly at the position shown below

Flare tool for R410A	Conventional flare tool	
	Clutch-type	Wing-nut type (Imperial-type)
A	0-0.5 mm	1.0-1.5 mm

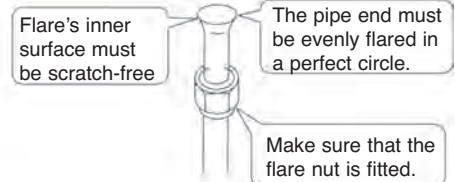

Connecting the refrigerant pipe

1) Use torque wrenches when tightening the flare nuts to prevent damage to the flare nuts and gas leaks.

Coat here with refrigeration oil

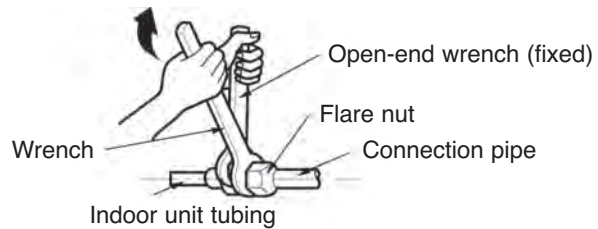
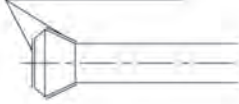

- 2) Align the centres of both flares and tighten the flares three or four turns by hand. Then tighten them fully with the torque wrenches.
- 3) To prevent gas leakage, apply refrigeration oil on both inner and outer surfaces of the flare. (Use refrigeration oil for R410A.)

Flare nut tightening torque		
Gaz side		Liquid side
09K/12K	18K	09K/12K/18K
3/8 inch	1/2 inch	1/4 inch
31-35 N.m	50-55 N.m	15-20 N.m

Caution handling piping

- 1) Protect the open end of the pipe from dust and moisture.
- 2) All pipe bends should be as gentle as possible.
Use a pipe bender for bending.
(Bending radius should be 30 to 40mm or larger.)

Selection of copper and heat insulation materials

- When using commercial copper pipes and fittings, observe the following:

- 1) Insulation material: Polyethylene foam
Heat transfer rate: 0.041 to 0.052W/mK (0.035 to 0.045kca/(mh°C)
The gas refrigerant pipe's surface temperature reaches 110°C max. Choose heat insulation materials that will withstand this temperature.

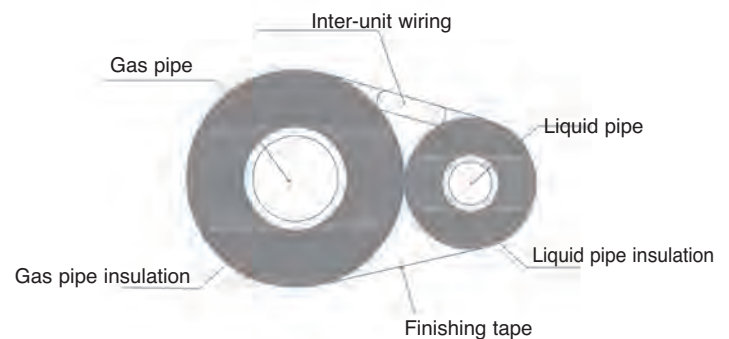
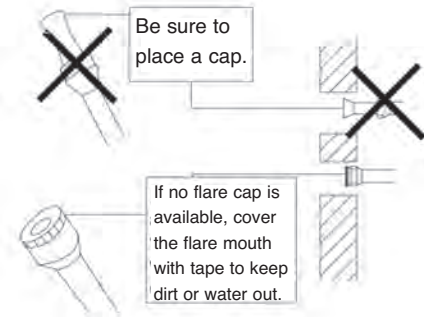

Gas side		Liquid side	Gas pipe thermal insulation		Liquid pipe thermal insulation
09K/12K	18K		09K	18K	
O.D. 9.55mm	O.D. 12.7mm	O.D. 6.4mm	I.D. 12-15mm	I.D. 14-16mm	I.D. 8-10mm
Thickness 0.8 mm			Thickness 10 mm min.		

3) Use separate thermal insulation pipes for gas and liquid refrigerant pipes.

Checking for gas leakage

- 1) Check for leakage of gas after purging air
- 2) See the sections on air purges and gas leak checks in the installation manual for the outdoor unit.

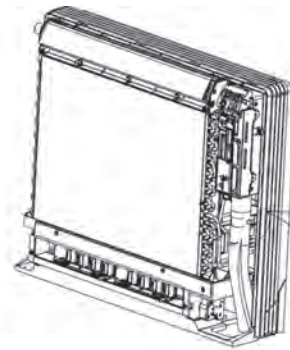

Check for leakage here
• Apply soapy water and check carefully for leaking gas.
• Wipe soapy water off after the check is complete.

Attaching the connection pipe

- Attach the pipe after checking for gas leakage, described above.
- 1) Cut the insulated portion of the on-site piping, matching it up with the connecting portion.
 - 2) Secure the slit on the refrigerant piping side with the butt joint on the auxiliary piping using the tape, making sure there are no gaps.
 - 3) Wrap the slit and butt joint with the included insulation sheet, making sure there are no gaps.

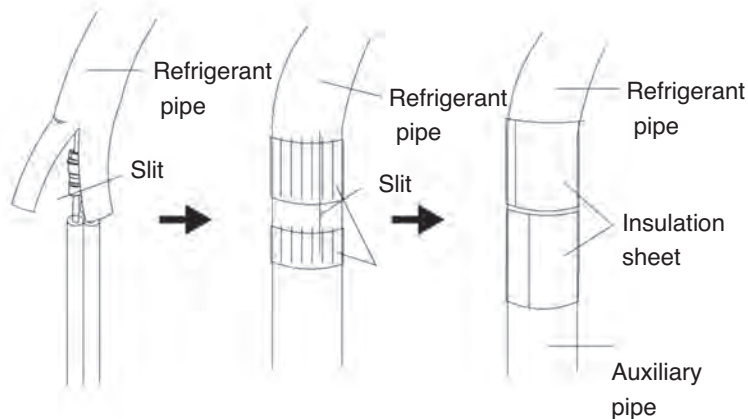

CAUTION

- 1) Thoroughly insulate the joint of the pipes.
Incomplete insulation may lead to water leakage.
- 2) Push the pipe inside so it does not place undue force on the front grill.

Connecting the drain hose

Insert the supplied C drain hose into the socket of the drain pan.
Fully insert the drain hose until it adheres to a seat of the socket.

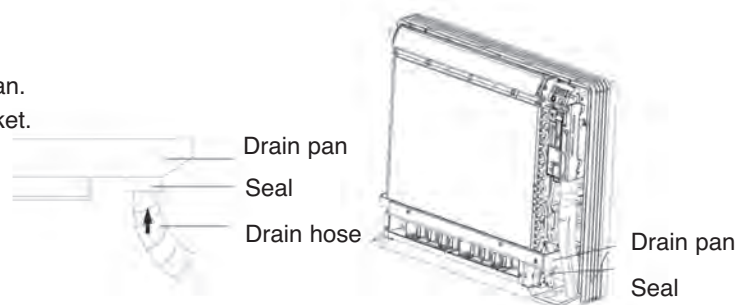

• Lift the sensor securing plate, remove the front metal plate cover, and connect the branch wiring to the terminal block.

- 1) Strip wire ends (15 mm)
- 2) Match wire colours with terminal numbers on indoor and outdoor unit's terminal blocks and firmly screw wires to the corresponding terminals.
- 3) Connect the ground wires to the corresponding terminals.
- 4) Pull wires to make sure that they are securely attached, then hold wires in place with wire retainer.

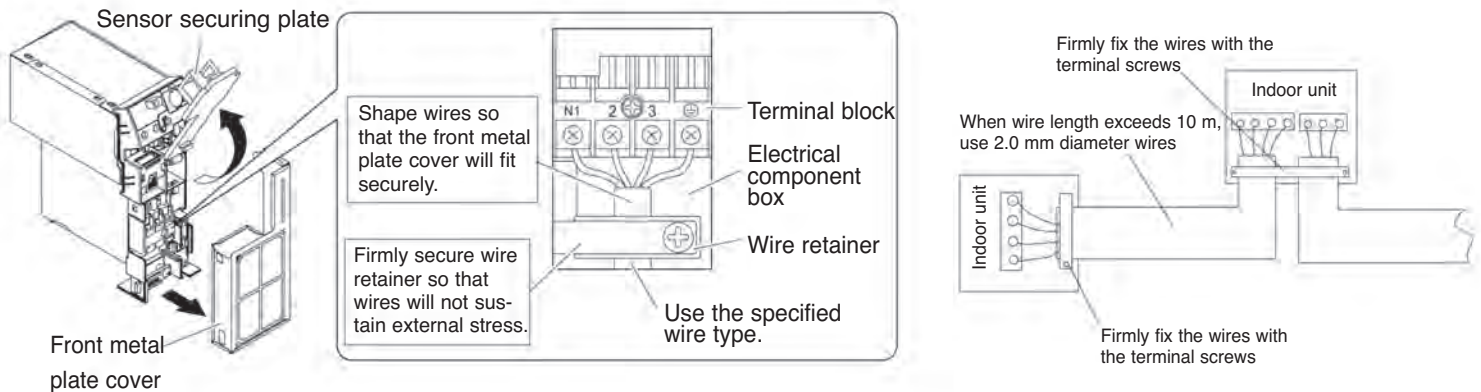

CAUTION

- 1) Do not use tapped wires, stranded wires, extension cords or starburst connections, as they may cause overheating, electrical shock or fire.
- 2) Do not use locally purchased electrical parts in the product. Do not attach the power for the drain pump, etc., to the terminal block. Doing so may cause electric shock or fire.

Check after installing

Items to be checked	Possible malfunction	Situation
Is the unit firmly attached?	The unit may fall, vibrate or emit noise.	
Has the refrigerant leakage test been done?	It may cause insufficient cooling capacity.	
Is the heat insulation sufficient?	It may cause condensation and dripping.	
Does the unit drain well?	It may cause condensation and dripping.	
Is the voltage in accordance with the rated voltage on the nameplate?	It may cause electric malfunction or damage the part.	
Is the electrical wiring and piping connection installed correctly and securely?	It may cause electric malfunction or damage the part.	
Has the unit been connected to a secure ground connection?	It may cause electrical leakage.	
Was the correct power cord used?	It may cause electric malfunction or damage the part.	
Are the intakes and outlets covered or blocked?	It may cause insufficient refrigerating capacity.	
Has the length of connection pipes and the refrigerant charge been record?	The refrigerating capacity may not be accurate.	

Configuration of connection pipe and additional volume of refrigerant

1. Standard length of connection pipe: 5m、7.5m、8m

2. Min length of connection pipe

For the unit with standard connection pipe of 5m, there is no limitation for the min length of connection pipe. For the unit with standard connection pipe of 7.5m and 8m, the min length of connection pipe is 3m.

3. Max length of connection pipe

Sheet 1 Max length of connection pipe

Capacity	Max length of connection pipe
5000 Btu/h (1465 W)	15
7000 Btu/h (2051 W)	15
9000 Btu/h (2637 W)	15
12000 Btu/h (3516 W)	20
18000 Btu/h (5274 W)	25

Unit: m

Capacity	Max length of connection pipe
24000 Btu/h (7032 W)	25
28000 Btu/h (8204 W)	30
36000 Btu/h (10548 W)	30
42000 Btu/h (12306 W)	30
48000 Btu/h (14064 W)	30

4. The calculation method of additional refrigerant oil and refrigerant charging amount after prolonging connection pipe

After the length of connection pipe is prolonged for 10m at the basis of standard length, you should add 5ml of refrigerant oil for each additional 5m of connection pipe.

The calculation method of additional refrigerant charging amount (on the basis of liquid pipe):

- (1) Additional refrigerant charging amount= prolonged length of liquid pipe × additional refrigerant charging amount per meter
- (2) When the length of connection pipe is above 5m, add refrigerant according to the prolonged length of liquid pipe. The additional refrigerant charging amount per meter is different according to the diameter of liquid pipe. See Sheet 2.

Sheet 2. Additional refrigerant charging amount for R22 R407C R410A and R134a

Diameter of connection pipe mm		Indoor unit throttle	Outdoor unit throttle	
Liquid pipe	Gas pipe	Cooling only, cooling and heating (g / m)	Cooling only (g / m)	Cooling and heating (g / m)
Φ6	Φ9.5 or Φ12	20	15	20
Φ6 or Φ9.5	Φ16 or Φ19	50	15	50
Φ12	Φ19 or Φ22.2	100	30	120
Φ16	Φ25.4 or Φ31.8	170	60	120
Φ19	-	250	250	250
Φ22.2	-	350	350	350

WARRANTY

LIMITED WARRANTY

This air conditioner is covered by a warranty against defects in materials and workmanship including the compressor, if used for the applications specified in this owner's manual, for a period of FIVE (5) YEARS from the date of original purchase in Canada.

Note : The internal compressor is covered by a 5-YEAR limited warranty.

During the warranty period, if this air conditioner fails under normal use, **GREE** will, at its option, either repair the unit or replace it, free of charge, within a reasonable period of time after the air conditioner is returned.

As a condition to any warranty service obligation, the customer must present this warranty certificate along with the proof of purchase.

THIS WARRANTY DOES NOT COVER :

1. Damage, accidental or otherwise, to the air conditioner that are not caused by materials or workmanship defect.
2. Damage caused by misuse, tampering or failure to follow the operating and maintenance instructions provided in this owner's manual.
3. Damage to the finish of the unit enclosure or to other outer features caused by wear.
4. Filter.
5. Damage caused by repairs or modifications to the air conditioner made by any person not duly authorized by **GREE**
6. Insurance and freight costs for the warranty service.

ALL IMPLIED WARRANTIES, INCLUDING ANY IMPLIED WARRANTY OF MERCHANTABILITY, ARE LIMITED TO A FIVE YEAR (5) PERIOD COVERED BY THIS EXPRESS LIMITED WARRANTY. **GREE** DISCLAIMS ANY LIABILITY FOR CONSEQUENTIAL OR INCIDENTAL DAMAGES AND, IN NO EVENT, SHALL **GREE**. LIABILITY EXCEED THE RETAIL VALUE OF THIS AIR CONDITIONER FOR BREACH OF ANY WRITTEN OR IMPLIED WARRANTY WITH RESPECT TO THIS AIR CONDITIONER.

**Keep this owner's manual along with your proof of purchase in a safe place for future reference.
You must provide proof of purchase for warranty service.**

Enter the following information on your air conditioner; it will help you upon getting assistance or service if you ever need it. You will have then to provide the model and serial numbers of the air conditioner – these data are detailed on the rating plate of the unit.

Dealer name : _____

Address : _____

Model number: _____

Serial number : _____

Date of purchase : _____