



Sol-Ark®



12K-2P-N
OUTDOOR



INSTALLATION GUIDE & OWNER’S MANUAL

UPON RECEIVING SHIPMENT	4
SPEC SHEET	5
WIRE GAUGE GUIDE (COPPER).....	7
WIRING DIAGRAMS	8
PHYSICAL INSTALLATION	17
INVERTER COMPONENTS.....	17
DECIDING BACKUP CIRCUITS.....	17
SINGLE SYSTEM INSTALLS.....	18
MOUNTING THE SOL-ARK.....	18
INTEGRATING BATTERIES (SOL-ARK POWERED "OFF").....	18
E.M.P SYSTEMS ONLY	19
CONNECTING SOLAR PANELS	19
INTEGRATING A GENERATOR.....	20
INTEGRATING SENSORS AND ACCESSORY PLACEMENT.....	21
POWERING-UP AND TESTING THE SOL-ARK 12K	23
CHECK THE VOLTAGE ON EACH PV INPUT CIRCUIT	23
WI-FI / INTERNET CONNECTION	24
REMOTE MONITORING SETUP	24
IP ADDRESS SETUP INSTRUCTIONS (PC OR SMART PHONE)	27
GUI SCREENS.....	29
PROGRAMMING GUIDE	31
MAIN SCREENS (TOUCHSCREEN)	32
BASIC SETUP	33
SYSTEM ALARMS.....	33
BATTERY SETUP	34
GRID SETUP	36
LIMITER SENSORS (CT SENSORS).....	39
LIMITER SENSOR AUTOMATIC SETUP.....	40
INSTALL TIPS	41
OFF-GRID INSTALL TIPS	41
GRID-TIE / NO BATTERY INSTALL TIPS	41
BATTERIES	42
BATTERY CHARGING INFORMATION	42
MODBUS/RJ45 APPLICATION NOTE.....	45
PARALLEL SYSTEMS.....	46
BEFORE ENABLING PARALLEL OPERATION	46
TROUBLESHOOTING GUIDE.....	49
TROUBLESHOOTING PHASING ISSUES.....	51
SOL-ARK 12K ERROR CODES.....	52
INSTALL VERIFICATION CHECKLIST	53
SOL-ARK 12K LIMITED WARRANTY	54



Disclaimer

UNLESS SPECIFICALLY AGREED TO IN WRITING, SOL-ARK:

(a) MAKES NO WARRANTY REGARDING THE ACCURACY, SUFFICIENCY, OR SUITABILITY OF ANY TECHNICAL OR OTHER INFORMATION PROVIDED IN ITS MANUALS OR OTHER DOCUMENTATION.

(b) ASSUMES NO RESPONSIBILITY OR LIABILITY FOR LOSS OR DAMAGE, WHETHER DIRECT, INDIRECT, CONSEQUENTIAL, OR INCIDENTAL, WHICH MIGHT ARISE OUT OF THE USE OF SUCH INFORMATION. THE USE OF ANY SUCH INFORMATION WILL BE ENTIRELY AT THE USER'S RISK.

Sol-Ark cannot be responsible for system failure, damages, or injury resulting from improper installation of their products.



The information included in this manual is subject to change without notice.

This version is for **OUTDOOR MODELS ONLY**; previous hardware versions of the Sol-Ark 12K are not compatible with the wire diagrams and instructions contained herein.













Contact Us:

PHONE	1-972-575-8875 x2
EMAIL	SUPPORT@SOL-ARK.COM
WEBSITE	WWW.SOL-ARK.COM

Warning Symbols

	This symbol indicates information that, if ignored, could result in minor injury or damage to the equipment.
	This symbol indicates information that, if ignored, could result in serious injury, damage to the equipment, or death.
	This symbol indicates information that is important but not hazard-related.

Warnings

-  Read this entire document before installing or using the Sol-Ark 12K inverter. Failure to follow any of the instructions or warnings in this document can result in electrical shock, serious injury, or death. Damage to the 12K inverter is also possible, potentially rendering it inoperable.
-  High Life Risk Due to Fire or Electrocution – **ONLY** qualified persons should install the Sol-Ark 12K inverter.
-  The system must have Ground connections and Neutral connections. Ground **MUST** be bonded to Neutral **ONLY ONCE** in the circuit.
-  Solar PV+/PV- are **UNGROUND**ED. Note, you may ground **PV Racking/Mounts**, but doing so directly to the Sol-Ark will likely result in damage in the case of a direct lightning strike to the PV array.
-  **DO NOT** connect the grid to the Load Output Terminal Block.
-  **DO NOT** reverse the polarity of batteries. Damage **WILL** occur.
-  **DO NOT** exceed 500Voc on any MPPT on the Sol-Ark.
-  **DO NOT** turn off the battery breaker if there is current flowing into our out of the battery in any amount.
-  **DO NOT** use impact drivers to tighten any fasteners on the Sol-Ark.
-  **MUST** use Strain Reliefs **ON ALL** wires entering/exiting the Sol-Ark 12K user area.
-  **MUST** use conduit (or double insulated wire) for AC Wires entering/exiting Sol-Ark 12K user area.
-  **ALL** terminals/breakers, including battery, MPPT, and AC Terminal Block inputs, should only have one conductor connecting to them.

Inspect Shipment

- A. Compare the package condition to the condition of the package in the photo we sent you before it left our facility.



You must note any damage due to shipping with delivery driver before accepting the package otherwise the shipping company will deny any claim.

- B. If damaged, contact us immediately at 972-575-8875 Ext. 3

Component Guide

- A. Limiter Sensors included: 5/8" CT sensors x2 (**Included**)
- B. Limiter Sensors, if purchased: 15/16" CT sensors x2 (**Available upon request**)
- C. Limiter Sensors, if purchased: 2" CT sensors x2 (**Available upon request**)
- D. Battery Temperature Sensor: for voltage adjustment
- E. Battery Cable Toroid x2
- F. CAT 5 cable for parallel communications
- G. WIFI Dongle: For software updates and remote monitoring (use M4x10 screws to hold in)
- H. French Cleat: For wall mounting the Sol-Ark 12K

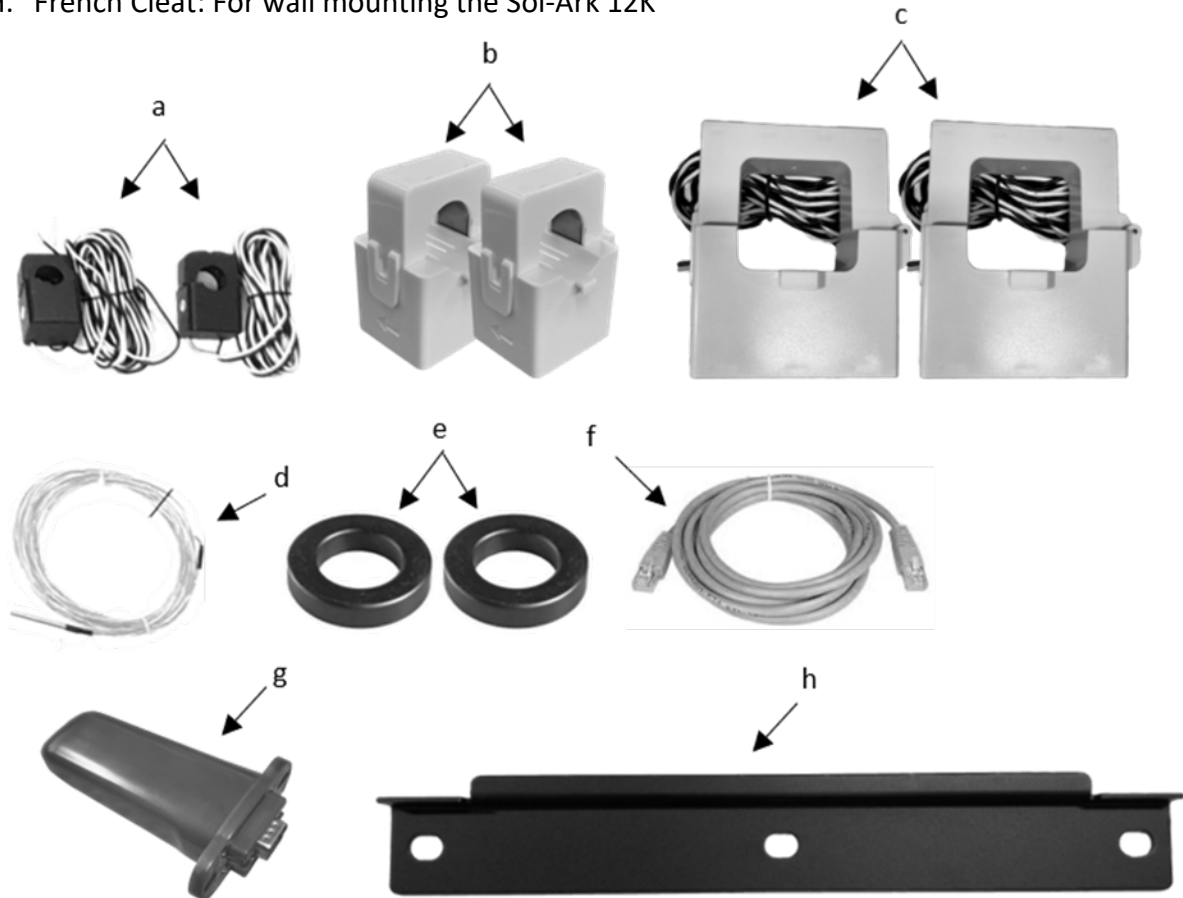



12K-2P-N

UL Model:

“Sol-Ark 12K-P”



Battery (Optional)		Output Power 9,000W
Type	Lead-Acid or Li-Ion	
Nominal DC Input	48V	
Capacity	50 — 9900Ah	
Voltage Range	43.0 — 63.0V	
Continuous Battery Charging Output	185A	
Charging Curve	3-Stage w/ Equalization	
Grid to Batt Charging Efficiency	96.0%	
External Temperature Sensor	Included	
Current Shunt for Accurate % SOC	Integrated	
External Gen Start Based on Voltage or %SOC	Integrated	
Communication to Lithium Battery	CanBus & RS485	

Solar		Input Power 13,000W
Max Allowed PV Power	6,500W + 6,500W = 13,000W	
Max PV Power Delivered to Battery & AC Outputs	12,000W	
Max DC Voltage (Voc)	500V @ 18A, 450V @ 20A	
MPPT Voltage Range	150-425V	
Starting Voltage	125V	
Number of MPPT	2	
Max Solar Strings Per MPPT	2	
Max DC Current per MPPT (Self Limiting)	20A	
Max AC Coupled Input (Micro/String Inverters)	9,600W	

General	
Dimensions (H x W x D)	30.0" x 18.3" x 10.0"
Weight	78 lbs
Enclosure	NEMA 3R
Ambient Temperature	-25-55°C, >45°C Derating
Installation Style	Wall-Mounted
Wi-Fi & LAN Communication	Included
Standard Warranty (verified by HALT Testing)	10 Years

AC		Output Power 9kW On-Grid & Off-Grid
Connections	120/240/208V Split Phase	
Continuous AC Power to Grid (On-Grid)	9,000W 37.5A-L (240V)	
Continuous AC Power to Load (Off-Grid)	9,000W 37.5A-L (240V)	
Surge AC Power 10sec	16,000VA L-L (240V)	
Surge AC Power 100ms	25,000VA L-L(240V)	
Fault Current 100ms	104A L-L (240V)	
Parallel Stacking	Yes	
Frequency	60/50Hz	
Continuous AC Power with Grid or Generator	15,120W 63A L-L (240V) 7,560W 63A L-N (120V)	
CEC Efficiency	96.5% (Peak 97.5%)	
Idle Consumption Typical—No Load	60W	
Sell Back Power Modes	Limited to Household/Fully Grid-Tied	
Design (DC to AC)	Transformerless DC	
Response Time (Grid-Tied to Off-Grid)	4ms	
Power Factor	+/- 0.9 - 1.0	

Protections & Certifications	
Electronics Certified Safety by SGS Labs to NEC & UL Specs - NEC 690.4B & NEC 705.4/6	Yes
Grid Sell Back — UL1741-2010/2018, IEE-E1547a-2003/2014, FCC 15 Class B, UL1741SA,	Yes
PV DC Disconnect Switch — NEC 240.15	Integrated
Ground Fault Detection — NEC 690.5	Integrated
PV Rapid Shutdown Control — NEC 690.12	Integrated
PV Arc Fault Detection — NEC 690.11	Integrated
PV Input Lightning Protection	Integrated
PV String Input Reverse Polarity Protection	Integrated
AC Output Breakers - 63A	Integrated
250A Battery Breaker / Disconnect	Integrated
Surge Protection	DC Type II / AC Type II

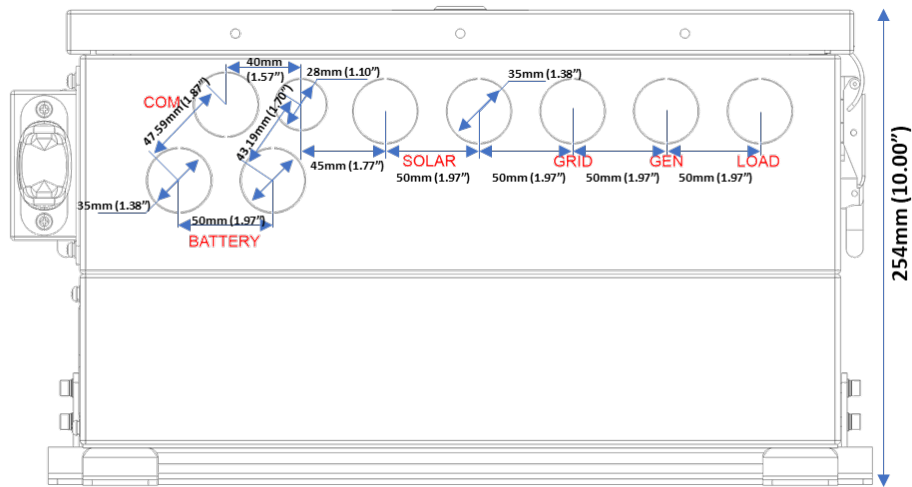
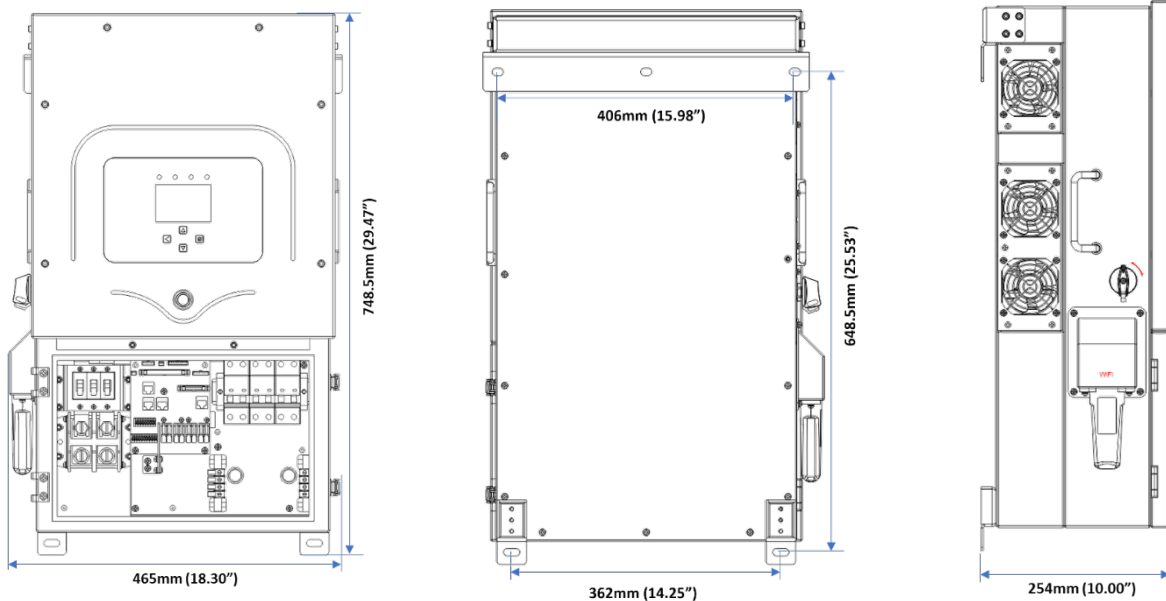

6" minimum clearance (12" IF NEXT TO ANOTHER SYSTEM)

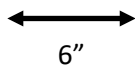

Temperature Derating
 DC: 90C-100C Shutdown @ 100C
 AC: 75C-82C Shutdown @ 82C

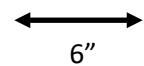

Sol-Ark 12K Torque Values Application Note

Load Breaker	26.5 IN Lbs	3 NM
Grid Breaker	26.5 IN Lbs	3 NM
Gen Breaker	26.5 IN Lbs	3 NM
Neutral / Ground Busbars	26.5 IN Lbs	3 NM
Cover Screws	26.5 IN Lbs	3 NM
Battery Connection	90.0 IN Lbs	10 NM



Do Not Use Impact Drivers to Tighten Any Fasteners on the Sol-Ark.

PV input: 10AWG

All AC Inputs/Outputs: 6-4AWG

All Sensors: 20-24AWG

CT Sensors: 10' Wire Included

Batt Temp Sensor: 6' Wire Included

RJ45 Cable: 7' Included (Extendable up to 20')

Battery input: 2/0-4/0AWG (3/8" Lugs)

15.875mm (5/8in)

23.813mm (15/16in)

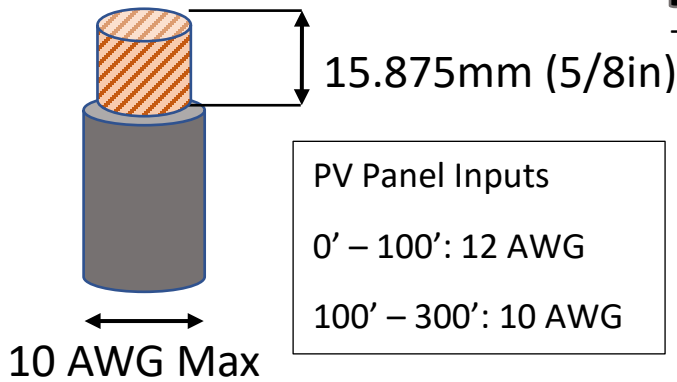
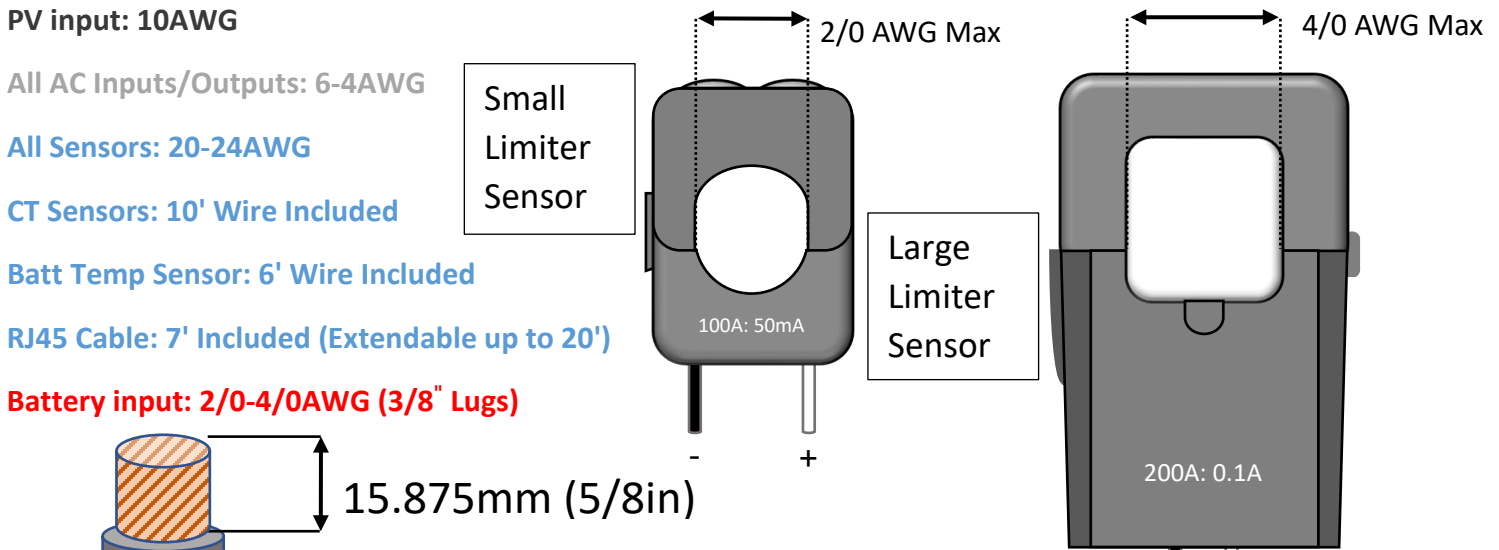

25.4mm (1.0in)

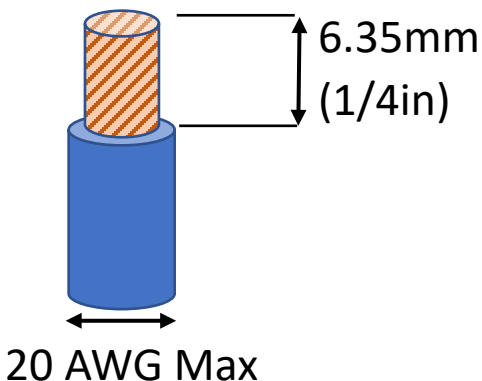
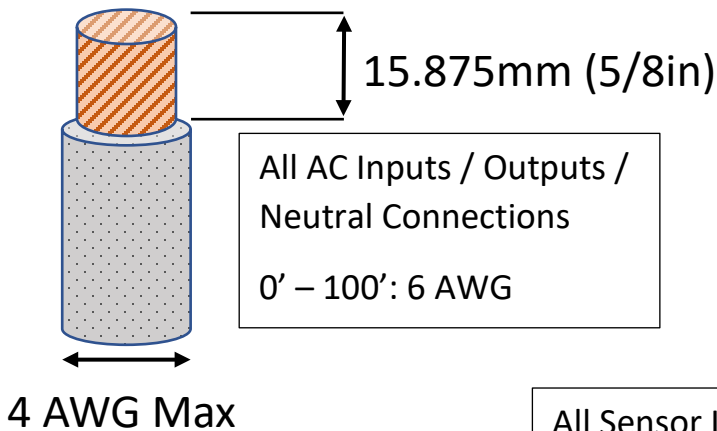
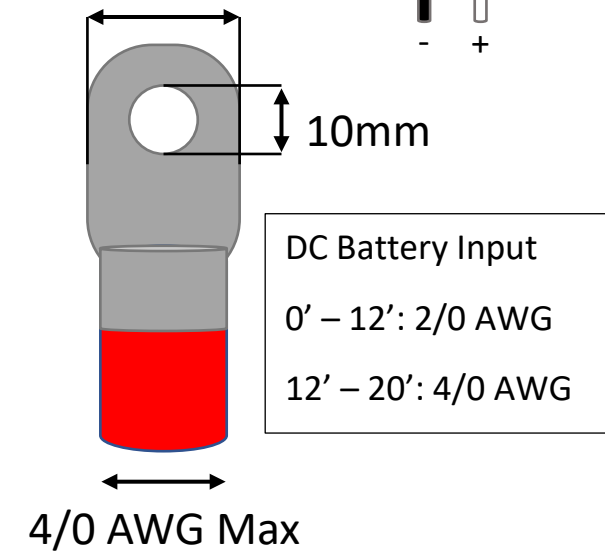

All Sensor Inputs
 0' - 100': 24 AWG
 100' - 400': 23 AWG CAT 6
 CT Wires Can Be Extended -Extensions for Limiter Sensors must be twisted pair (See [pg. 39](#))
(Shielded CAT6 Recommended)



These Single Line Diagrams (SLDs) are examples of common-use cases for Sol-Ark inverters.

Sol-Ark does not provide custom diagrams; however, you may contact support@sol-ark.com for any questions about an existing SLD.

Sol-Ark Off-Grid Standard Wire Diagram 120V/240V

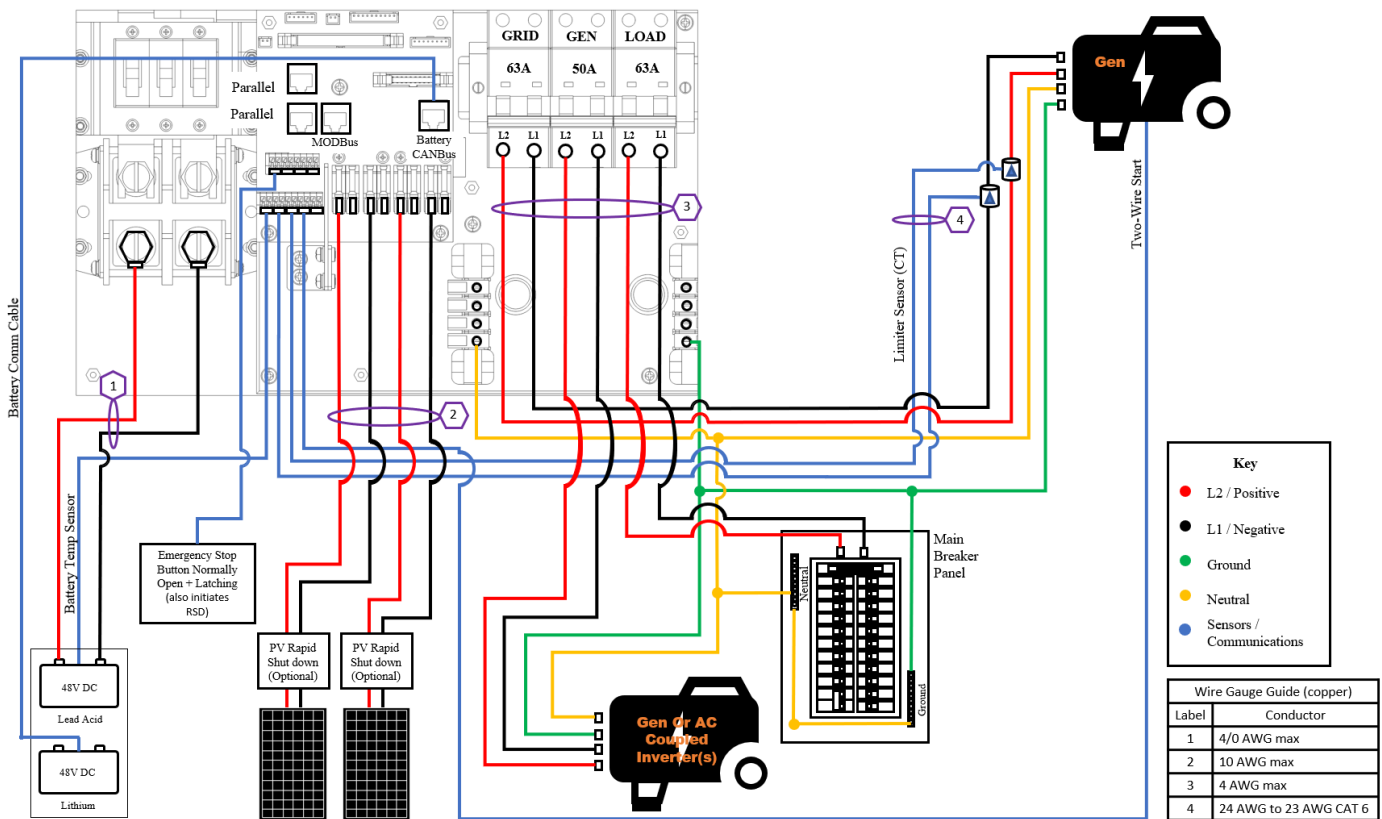

NOTE: Location of the neutral-to-ground bond will depend on local code

Diagram 1

CT Sensors are optional but necessary to enable Peak Shaving.

See pg. 21 and pg.39 for additional info.

Diagram 2

Sol-Ark Standard Wire Diagram 120V/240V

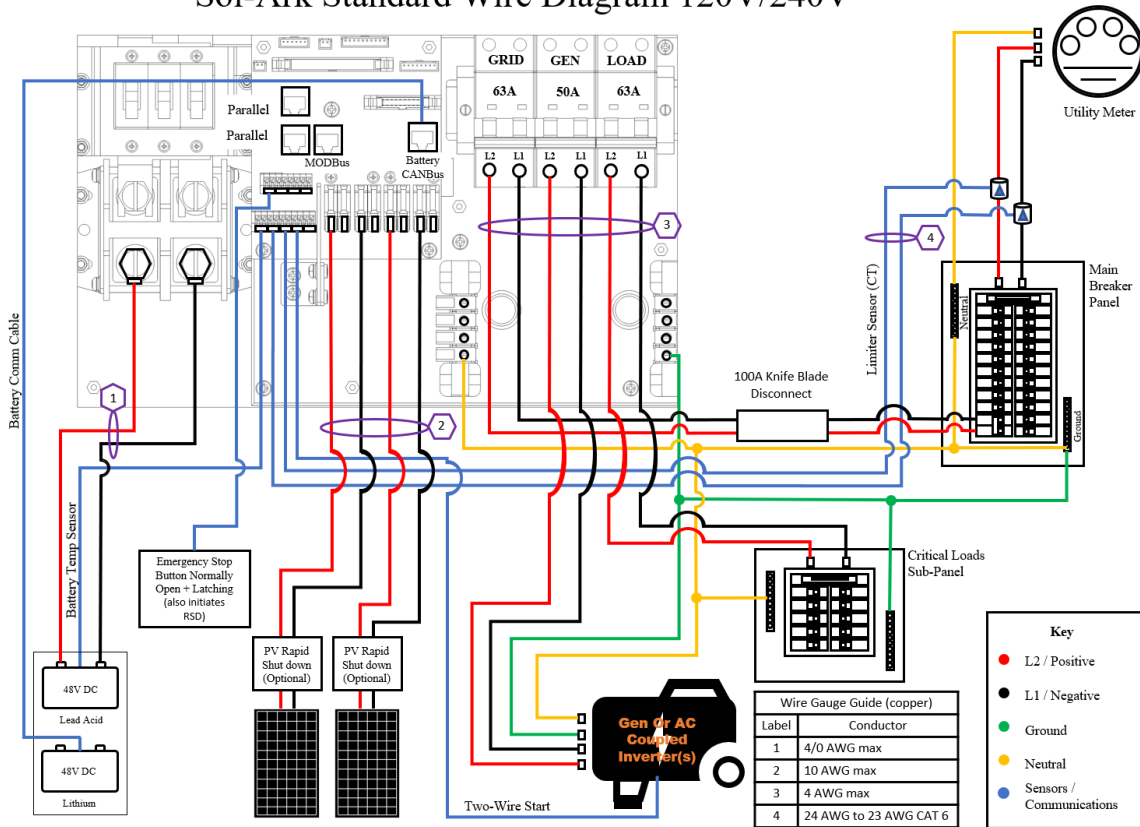

NOTE: Location of the neutral-to-ground bond will depend on local code
 NOTE: Size of disconnect will depend on required passthrough

Diagram 3

Sol-Ark Load Side AC Coupled W/ Micro Inverters Wire Diagram 120V/240V

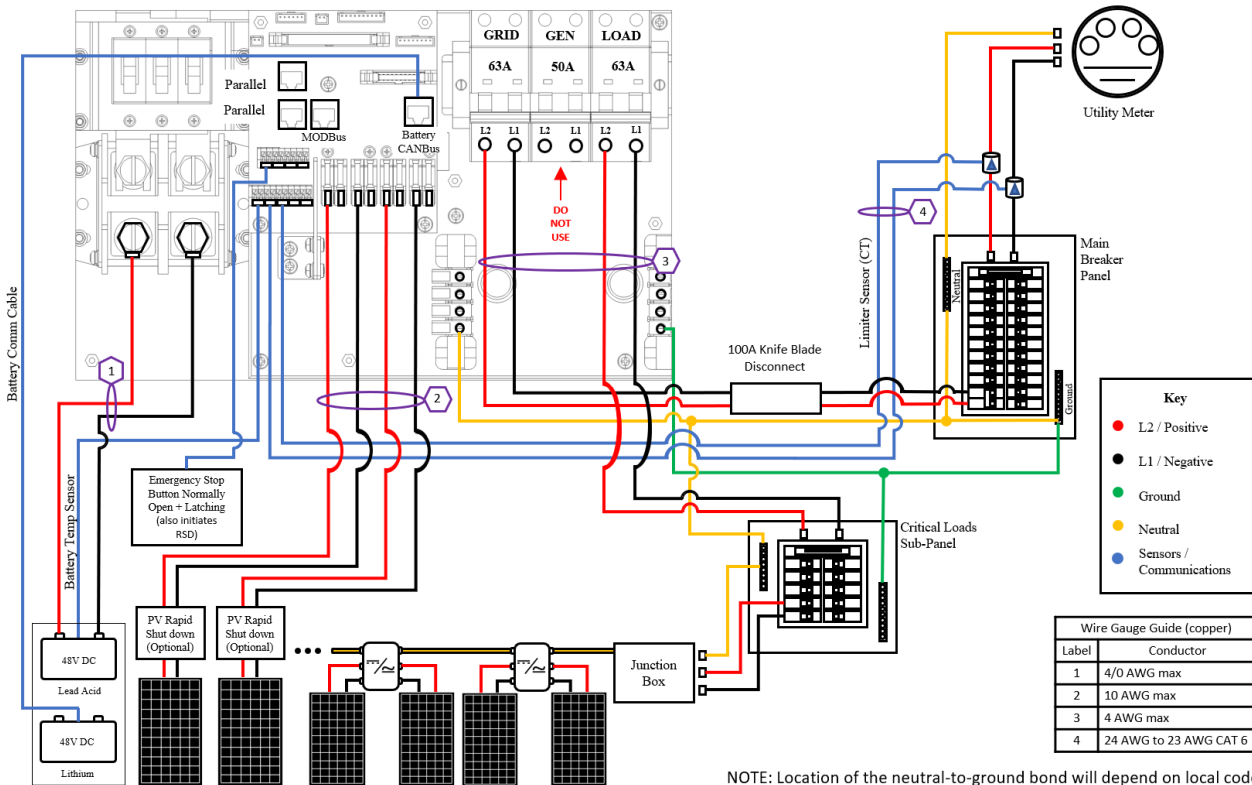

NOTE: Location of the neutral-to-ground bond will depend on local code
 NOTE: Size of disconnect will depend on required passthrough

Sol-Ark AC Coupling W/ Micro Inverters Wire Diagram 120V/240V

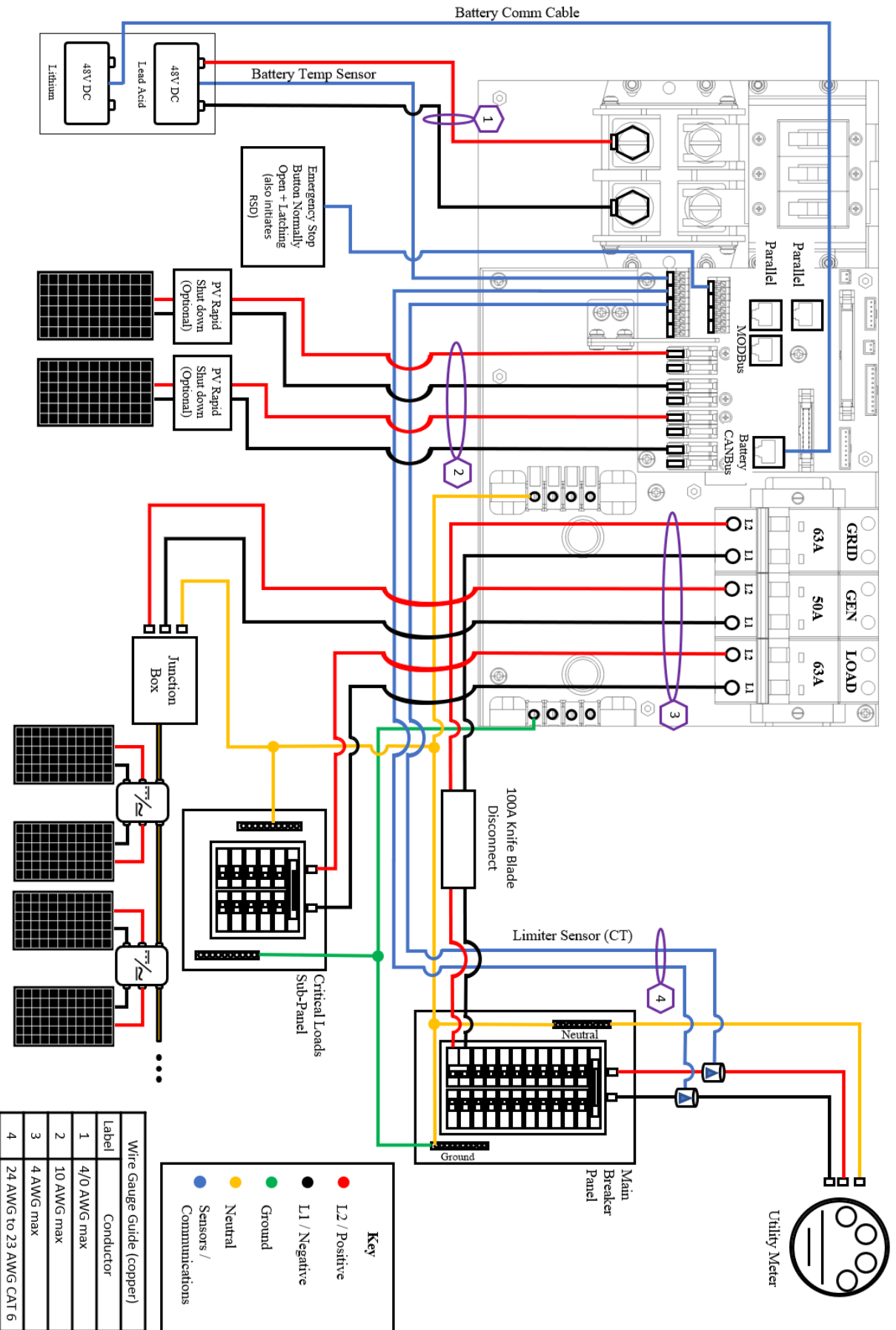

Diagram 4

Sol-Ark Whole Home Generator Wire Diagram 120V/240V

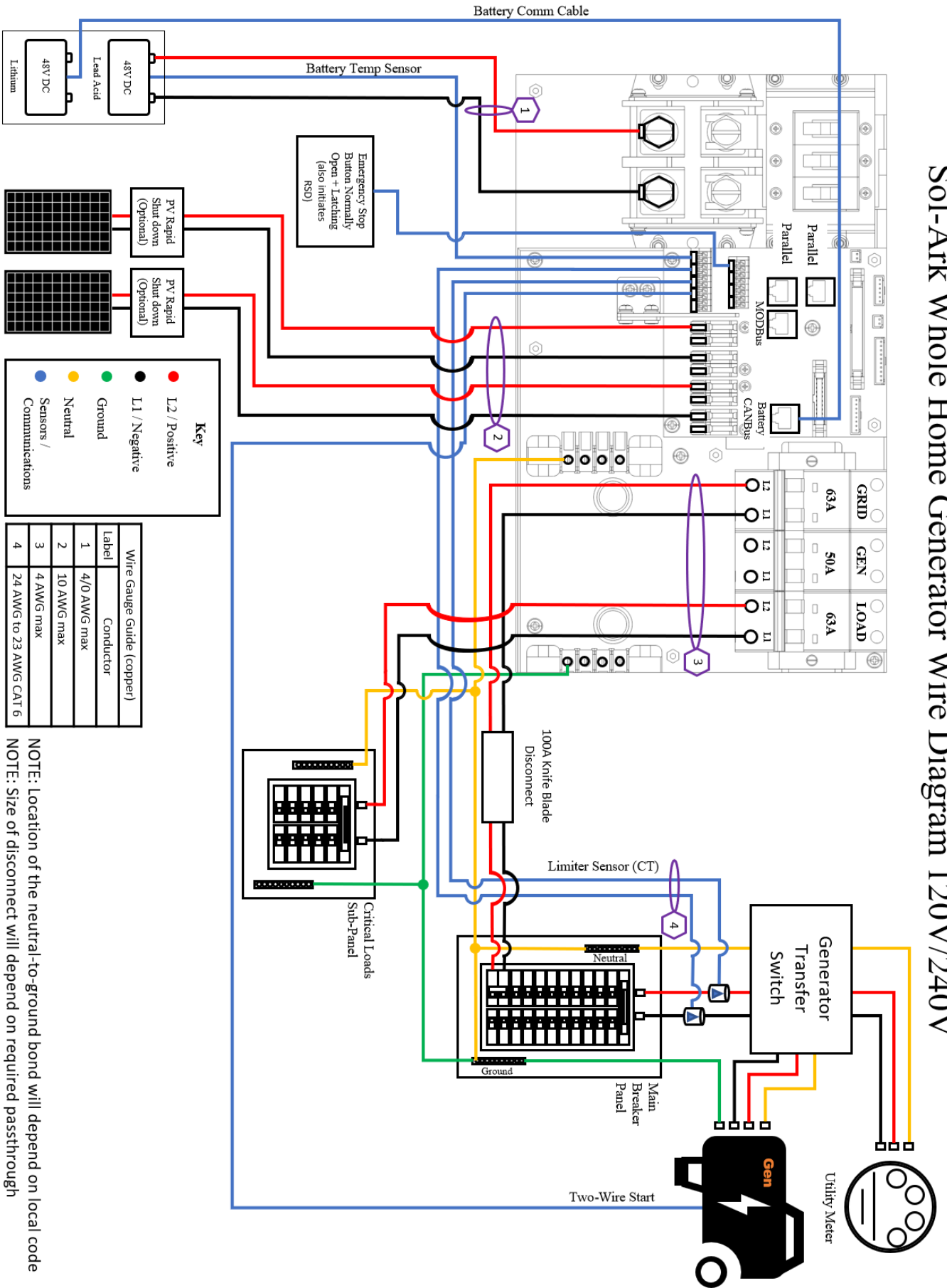
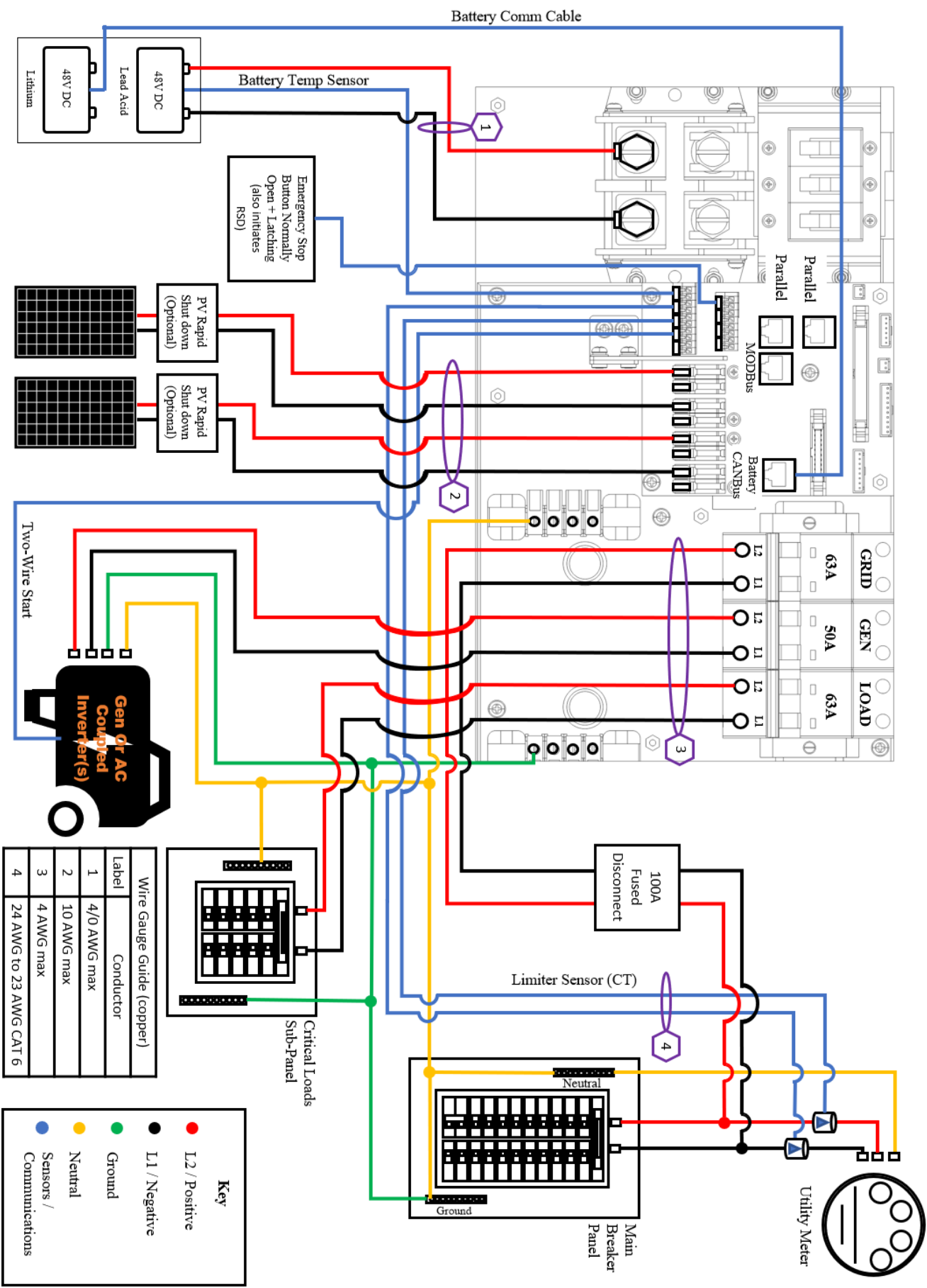

Diagram 5

Sol-Ark Line Side Tap Standard Wire Diagram 120V/240V



NOTE: Location of the neutral-to-ground bond will depend on local code
 NOTE: Size of disconnect will depend on required passthrough

Diagram 6

Note: Before powering up Parallel System installs, Aplease see Parallel System app note

Sol-Ark 12K x2 Standard Wire Diagram 120V/240V

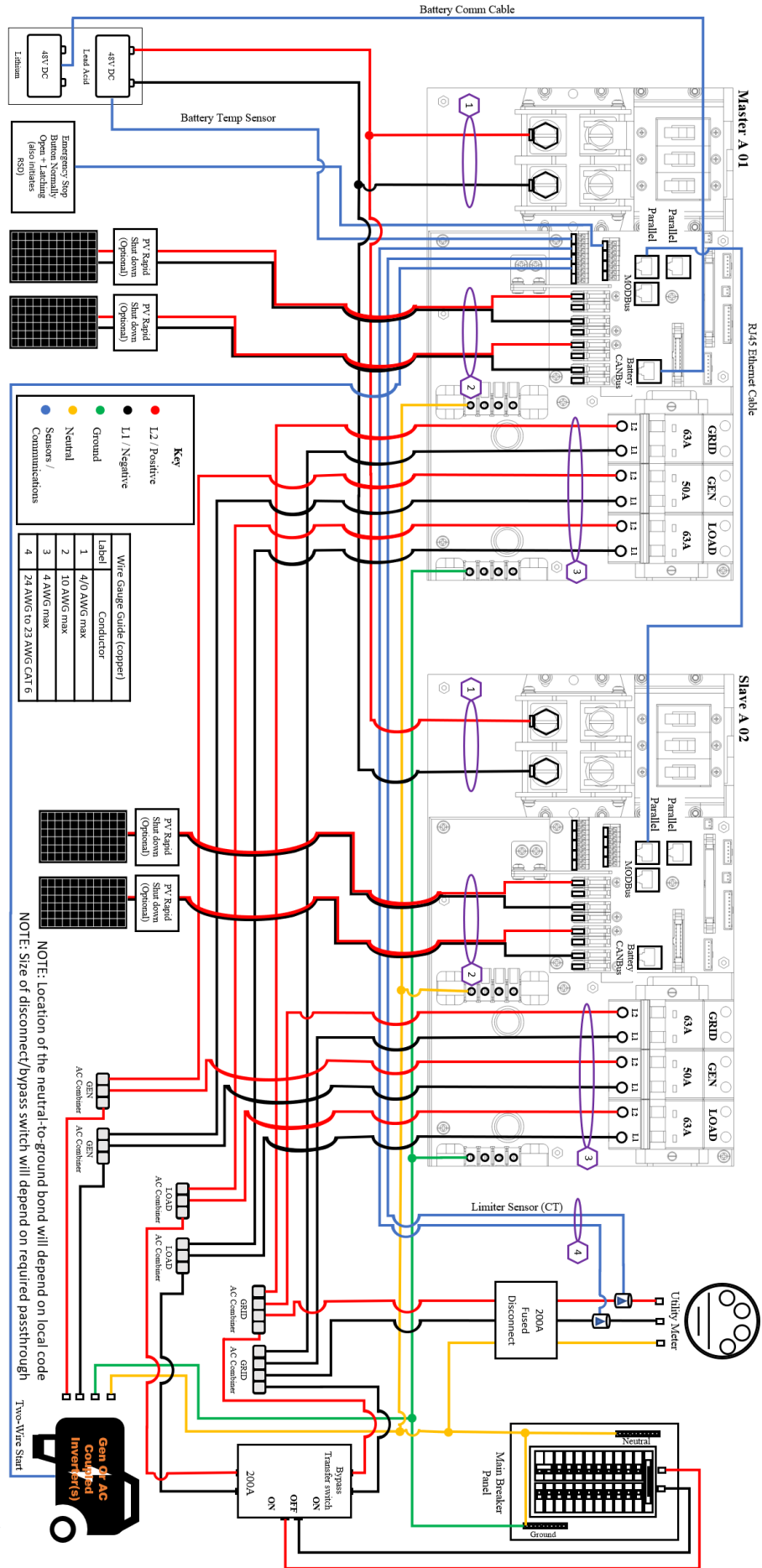

Diagram 7

Sol-Ark 12K x3 Standard Wire Diagram 120V/240V

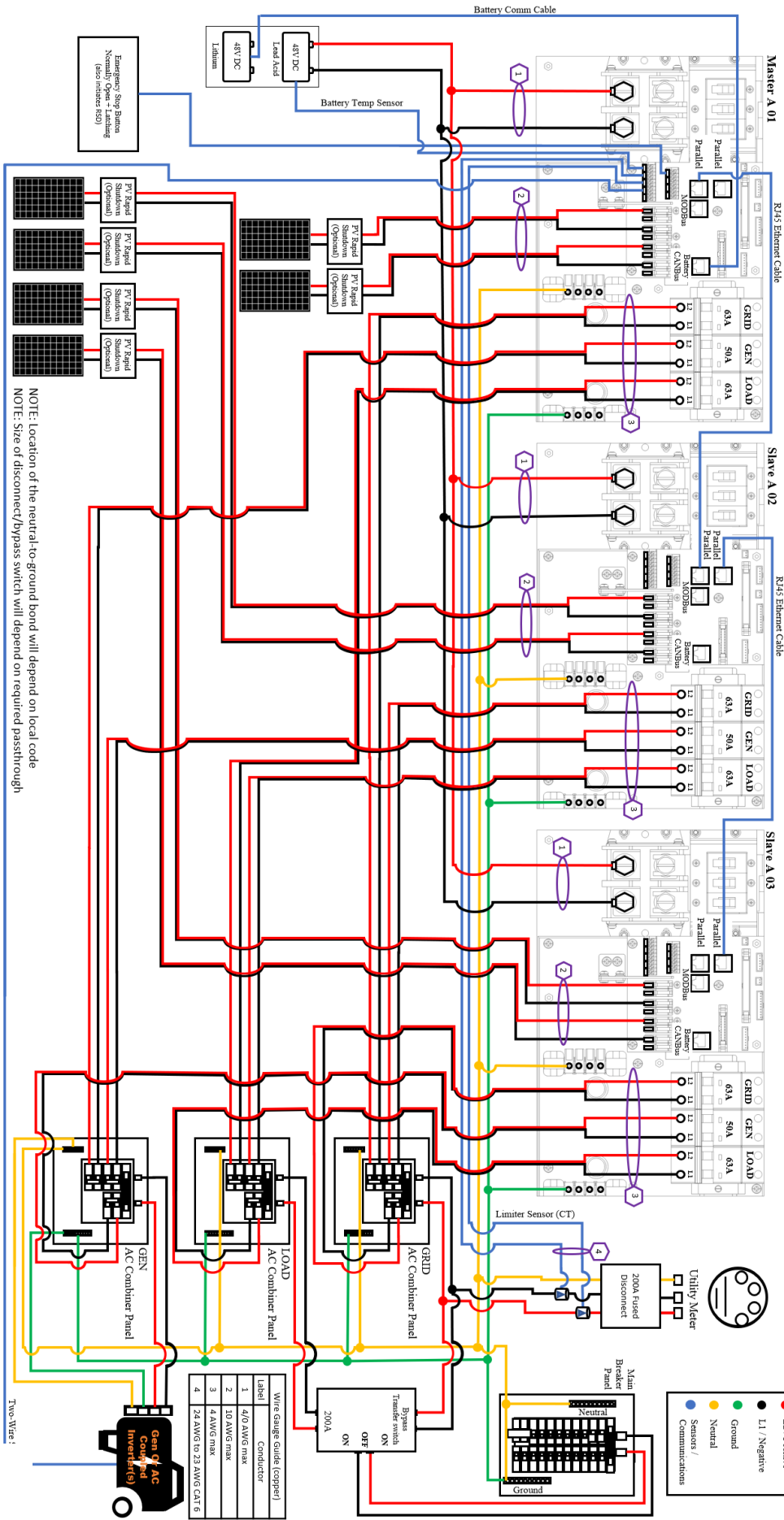

Diagram 8

Note: Before powering up Parallel System installs, please see Parallel System app note

Sol-Ark 12K x2 Wire Diagram 120V/208V

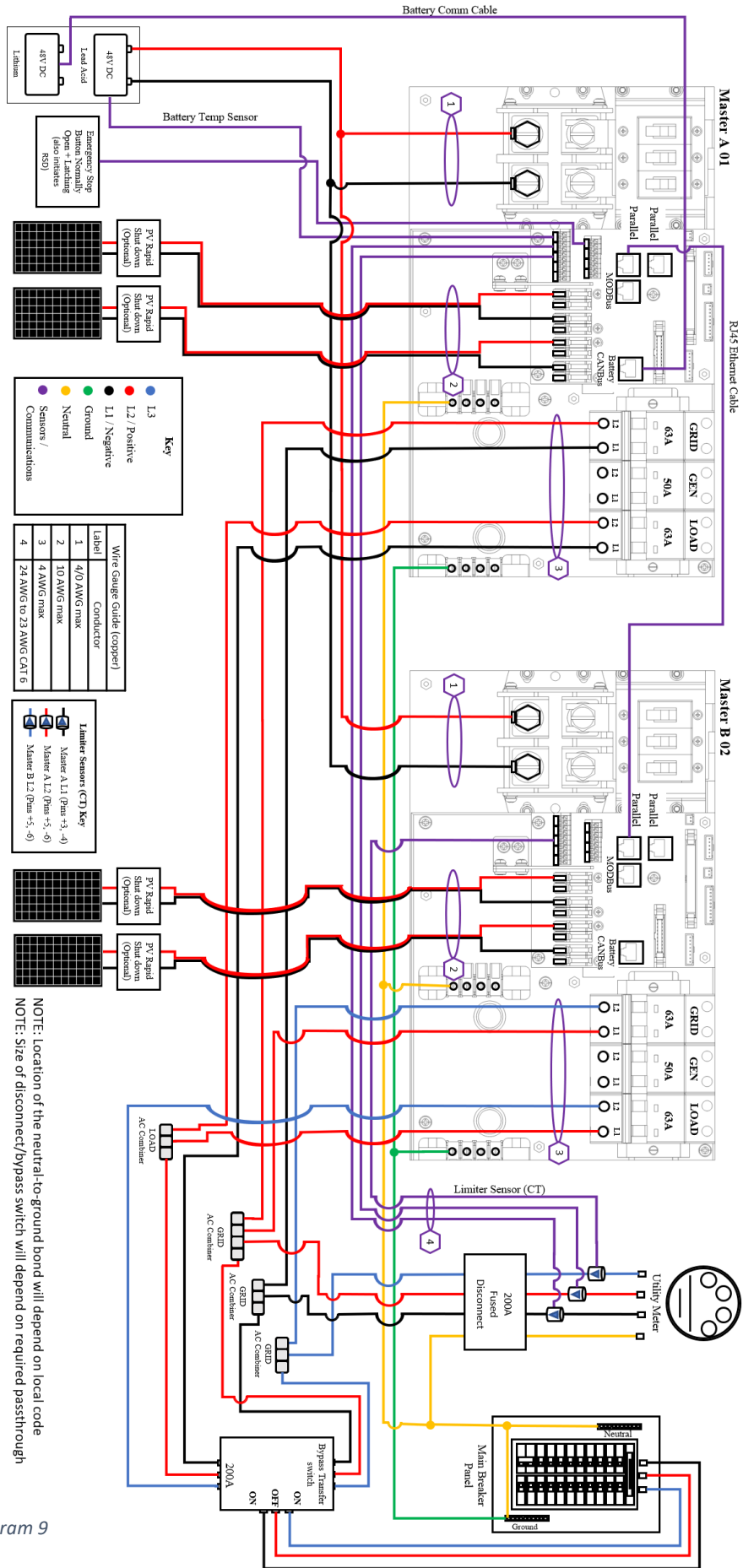

Diagram 9

Note: Before powering up Parallel System installs, please see Parallel System note

Sol-Ark 12K x3 Wire Diagram 120V/208V

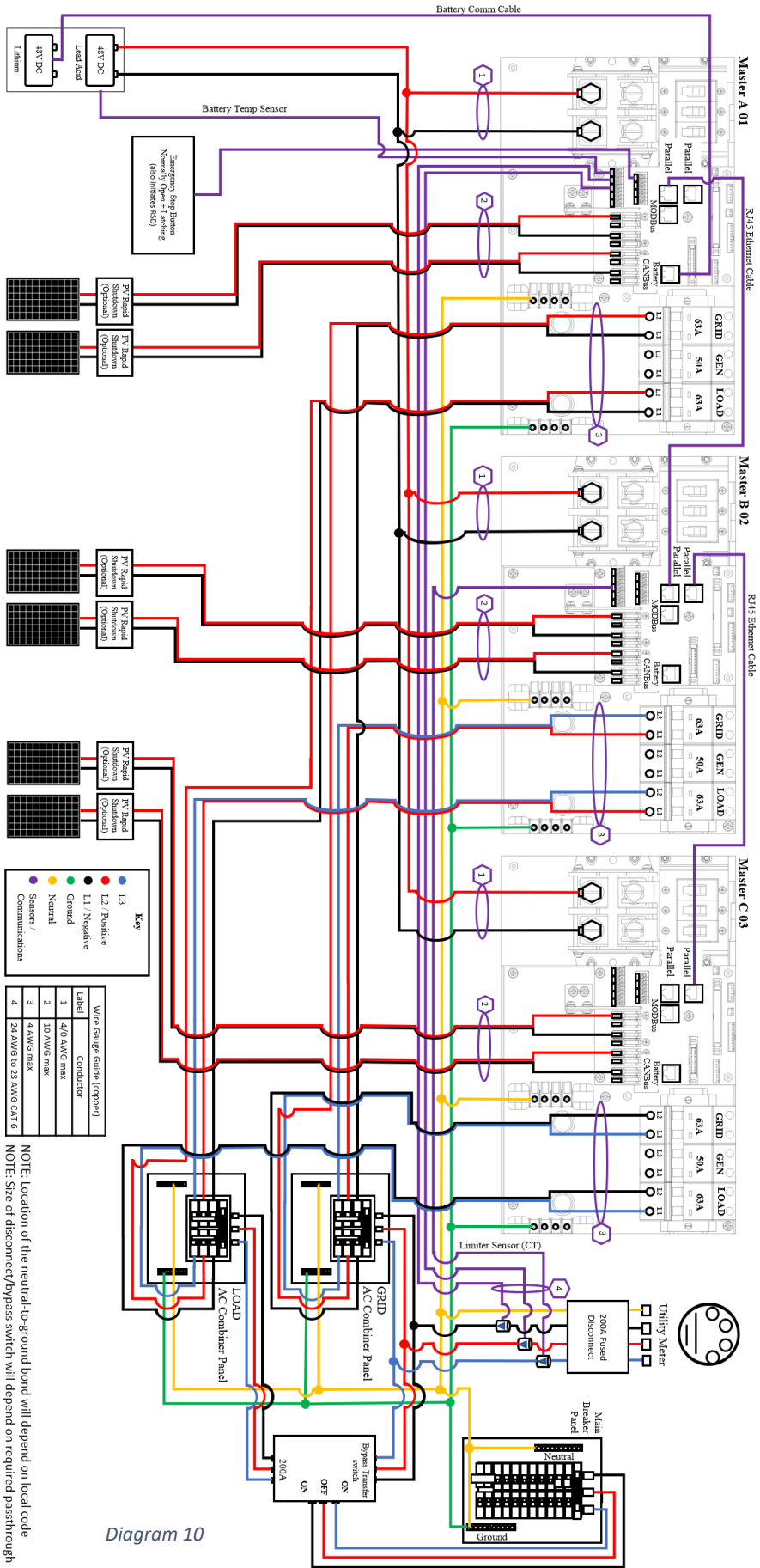
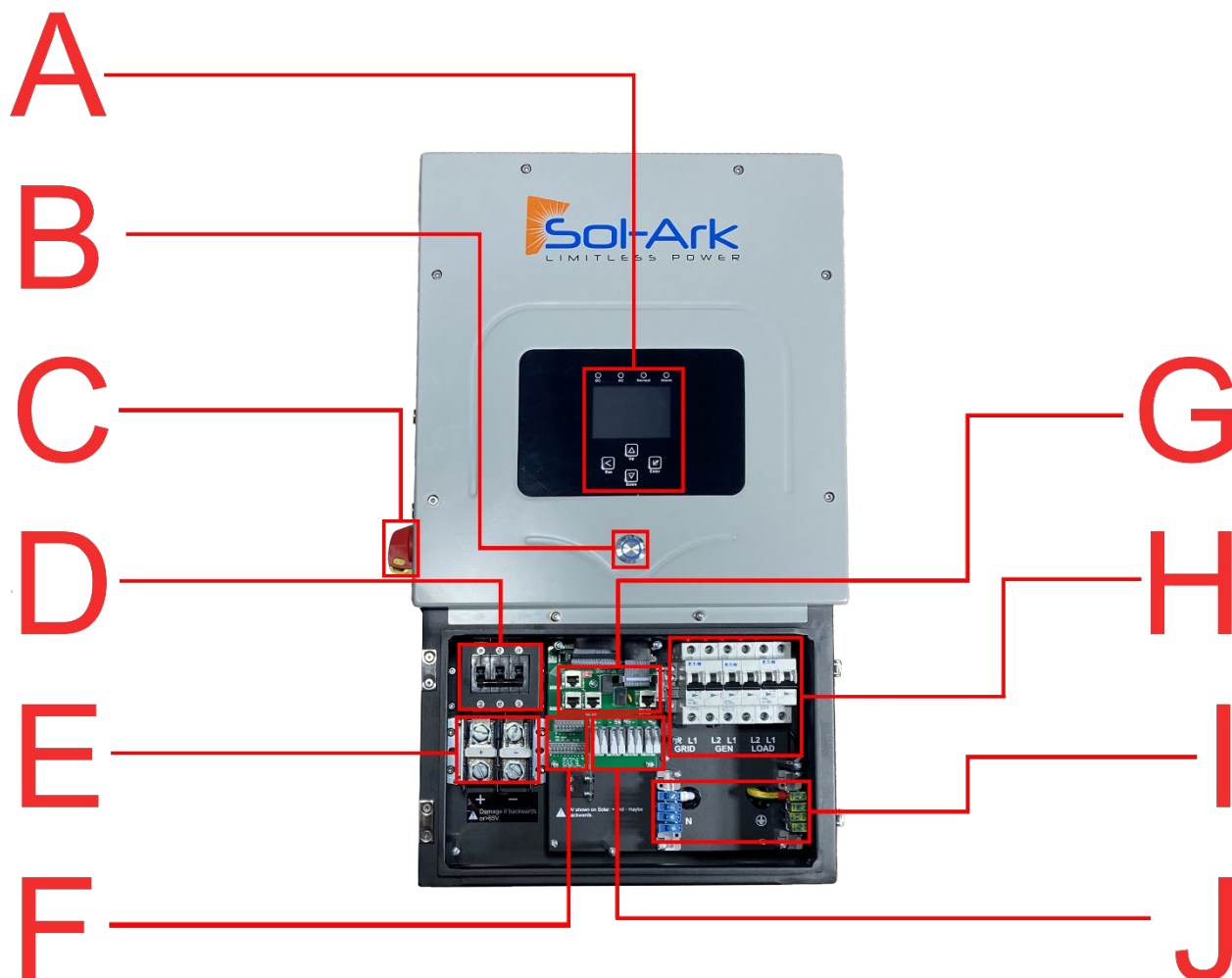

Diagram 10

Inverter Components



- A. LCD Touch Screen**
- B. Power Button**
- C. PV DC Disconnect Switch**
- D. 250A Battery Breaker**
- E. Battery Terminals (+/-)**

- F. Sensor Pin-Out Board**
- G. Comms/Paralleling Ports**
- H. AC Breakers (Grid 63A/Gen 50A/Load 63A)**
- I. Neutral/Ground Bus Bar**
- J. MPPT Charge Controllers**

Deciding Backup Circuits

- A. We recommend subpanels and require them if you have Arc-Fault / GFI breakers
- B. Ensure you keep the Inverter within its amperage limits
 - ON-Grid = 63A Continuous (pass-through)
 - OFF-Grid = 37.5A Continuous | 67A Peak (10s) | 104A Peak (100ms)
- C. Verify each load circuit by measuring typical and max Amps with a clip-on Amp meter. Amps x 120V = Watts
- D. Install a subpanel for backup loads if you have Arc-Fault / GFI breakers, NOT a multi-circuit transfer switch

Single System Installs

- Install Double Pole 60A breaker in Main Panel for Grid In/Out
- Best practice to install at the opposite end of the bus bar from the main breaker, which is usually at the bottom of the breaker panel (see figure above)

Mounting the Sol-Ark

- Keeping in mind Sol-Ark's dimensions, find a suitable location for the system (s)
- NEMA 3R rating for Outdoor installations
- PROTECT the LCD screen from excessive UV exposure**
- System weight = 78lbs (35kg). Securely attach to the wall. Affix a mounting board to studs using 6-8 screws
- Using 2-3 screws + washers (choose screw length and surface type) to mount the French Cleat to the board/wall
- Mount Sol-Ark on the installed French Cleat / Ensure Sol-Ark is level and sits properly
- Add two screws for the bottom mount



Integrating Batteries (Sol-Ark POWERED "OFF")

- Connect batteries to Sol-Ark as shown in Fig. B below
- Install included toroids (Part e. on pg. 4) on battery input cables as shown in Fig. A to the right
- Ensure the built-in battery disconnect is OFF while connecting batteries, or arcing may occur



Fig. A

Multi-System Installs

- ALL paralleled systems MUST connect to the same large battery bank, each with its own cables attached
- Do NOT use separate battery banks for parallel systems**

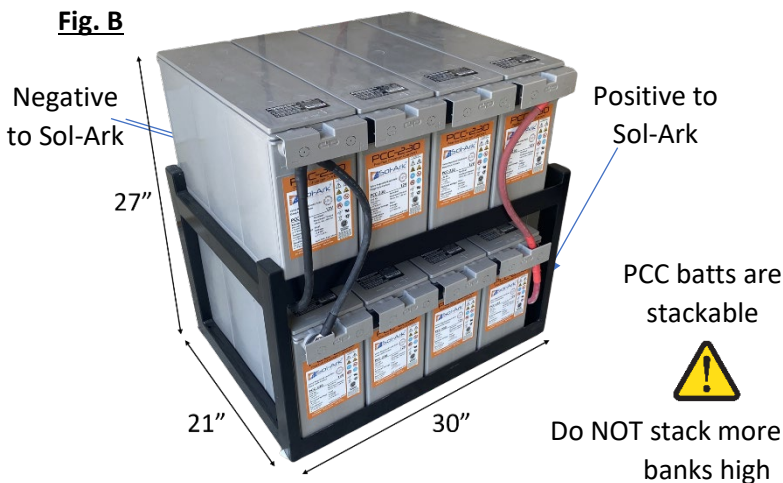

Sol-Ark 12K is a **48V** system. Do NOT wire the battery bank to any other nominal voltage.

When using 12V batteries do not exceed FOUR (4) batteries in series.

When using other battery chemistries, stay within the voltage range: MIN 43V-MAX 63V

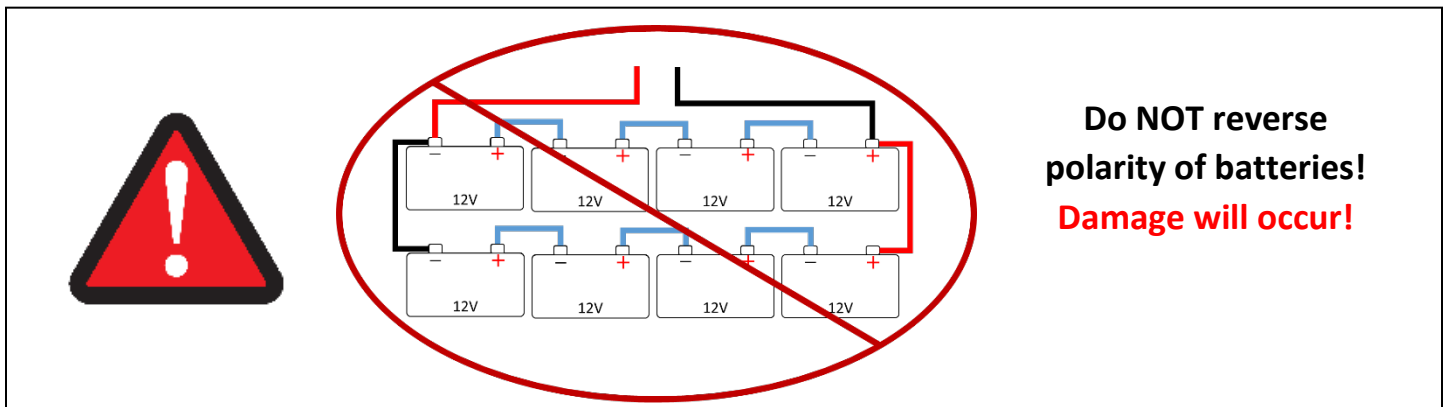

E.M.P Systems Only

Suppressor installation

- If you purchased your system with Lightning / EMP Hardening, most protection is in the Sol-Ark. However, you also have EMP suppressors installed on the power cords of appliances connected to the transfer switch. Although not critical, it is recommended they be installed as close as possible to the appliance.
- You also have EMP suppressors installed on both solar panel wires with a zip tie. Closer to the panel is better. If you purchased the panels from us, we already installed >150kV/m protection inside the solar panels.

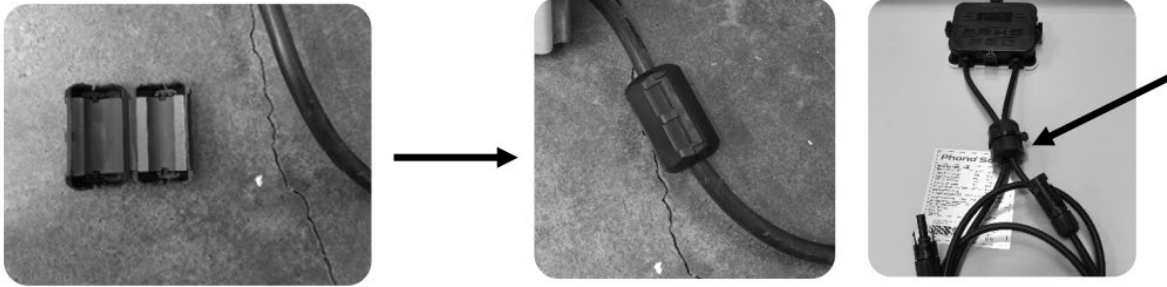

If using panels not from Sol-Ark

Connecting Solar Panels

- Sol-Ark has DUAL MPPTs for two separate PV input pairs
- MAX PV input = 13kW ($\pm 5\%$) / system | 6.5kW / MPPT | MAX 500V_{oc} PV | MAX I_{sc}/MPPT 25A (limiting to 20A)



Damage will occur if PV V_{oc} > 550V

- Parallel strings per MPPT must be the same Voltage
 - PV1 A/B must be the same voltage if using both strings
 - Panels on the same MPPT CAN face different directions
- GND the panel MOUNTS/FRAMES to any ground **outside** the circuit via 12AWG wire
- IF using Y-Connectors: Running two strings in parallel, totaling 20A (self-limiting)**
- Connect the solar panel strings as indicated by the following diagram:



Each string **can** use separate wires

String minimum is usually 5 panels or 175V

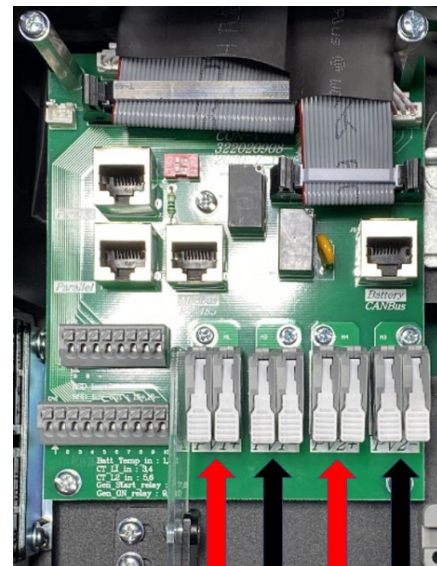
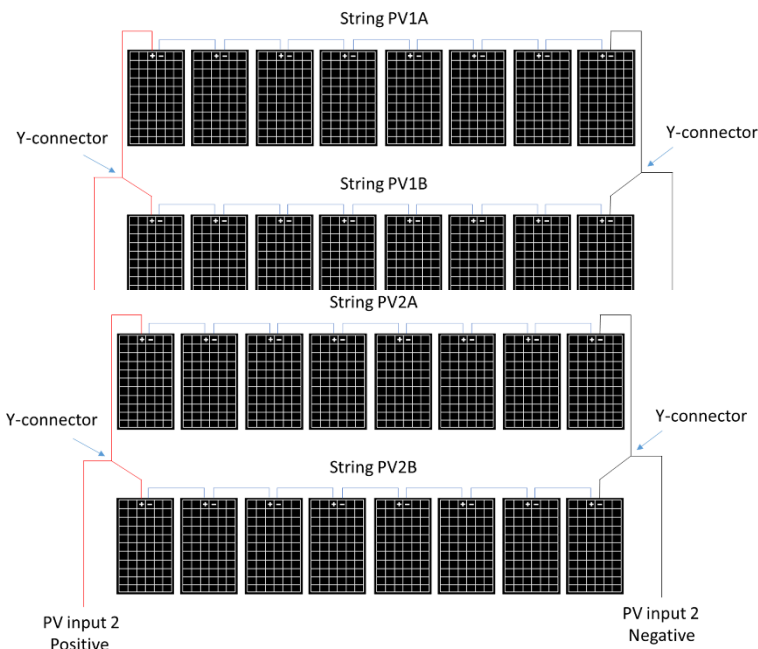

Integrating a Generator

Generators < 10kW (GEN Breaker)— See Diagram 1-2

- A. ONLY supports 240V generators | 50A breaker
- B. Connect the generator output to the "GEN" input breaker in the Sol-Ark 12K user area. **GEN input doesn't support 3-Phase Generators.**
- C. THD of less than 15% is preferred but not required

Standby Generators > 10kW (GRID Breaker)— See Diagram 1 (OFF-GRID)

- A. Supports 220V / 240V / 208V generators | Depends on "Grid Type" selection | 63A breaker
- B. **Off-Grid** / Whole-home Generator on ATS installations require selecting "GEN Connected to Grid Input"
Home Screen → Gear Icon → Grid Setup → Sell Control → GEN Connected to Grid Input
- C. Off-Grid = turn "Grid Sell" off | Only need CTs (on Gen lines) if using Grid Peak Shaving (see below)



Increase Gen/Sol-Ark efficiency

1. Select "Limited to Load"
2. Select "General Standard"
3. Increase Grid frequency range: 55-65H

Weekly Gen Exercise

If the Sol-Ark is up to date with MCU version xx73 or newer, and your generator has two-wire start compatibility, you will experience weekly generator tests.

These tests occur at 8AM (local time) every Monday by default.

The test takes approximately 20 minutes to complete. During that time, the generator will auto-start and auto-stop.

The generator will not provide power during this test. The generator may charge the batteries if the batteries reach designated generator start point, however.

Grid Peak Shaving Mode (For Gen Connected to Grid Breaker)

- A. Prevents the Sol-Ark from overloading generators
- B. Must place the CT sensors so that they measure L1 and L2 of the generator's output, pointing arrows on the CTs toward the generator
- C. Sol-Ark contributes power above the "Power" value threshold to prevent overloading the generator
- D. This mode will auto-adjust the Grid Charge Amperage to avoid overloads

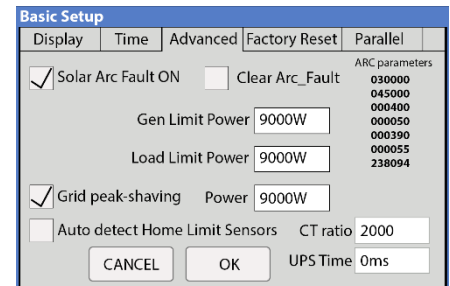

Gen Start V or % (Grid Start if Gen on Grid Breaker)

Value batts need to reach **BEFORE** automatically starting a generator connected to the GEN breaker to charge the battery bank.



Sol-Ark will NOT charge batteries from a generator until the batteries reach this value.

Gen Start A (Grid Start if Gen on Grid Breaker)

This is how many amps (**DC**) you can pull specifically from the generator to charge the batts. To ensure you do not overload a small Generator, you will want to adjust the GEN or GRID Start A value. **Multiply value by # of Sol-Arks for actual current value into batteries.**

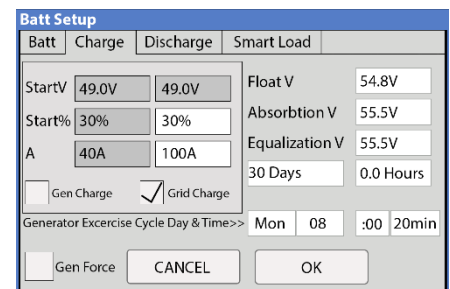

Suppose PV production = 0W | Disabled TOU | Enabled Grid/Gen Charge: the batteries will be charged to "full" using the Grid or a Generator (if available) until the battery bank accepts only 5% of its rated capacity in Amperes. This value correlates to roughly 90-93% full for most batteries and is the generator's default "OFF" signal. If producing PV, the system will use PV to charge the batteries to 100% full instead.

Integrating Sensors and Accessory Placement

Sensor Pin Out (Located in Sol-Ark user)

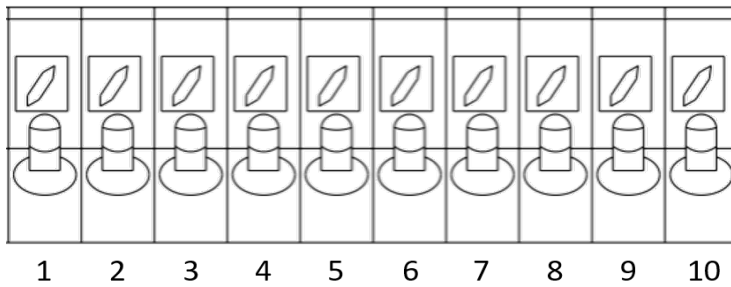
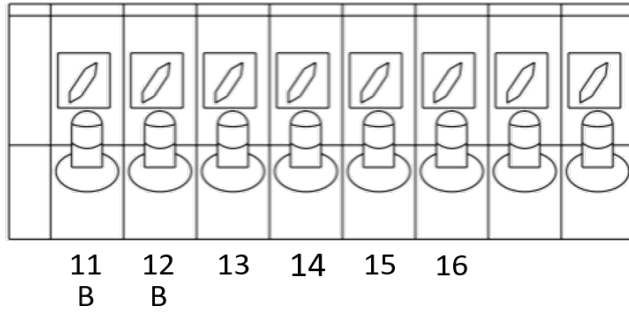

(1,2) Batt Temp: Battery Temperature Sensor has no polarity and is needed for voltage correction when using lead acid batteries.

(+3, -4) CT1 & (+5,-6) CT2: Current transformers used for limited to home mode and peak shaving

(7,8) Gen Start Relay: Two wire start for generators, simple open or closed relay

(9,10) Gen On Relay: Not currently used

(B 11, B 12) Emergency Stop: Short these pins to initiate emergency stop. This will shutdown AC output from the inverter and initiate rapid shutdown of the PV.

(+13, -14) Optional 12V input signal for RSD

(+15, -16) 12V power supply for RSD transmitters: such as TIGO and Midnite
 Rated for a **maximum of 1.2W (100mA @12V)**

Battery Temperature Sensor

- Place between batteries with tape (See Fig. C).
- This sensor has no polarity and helps perform voltage charging adjustments and capacity calculations.

 **Note:** Lithium Batteries do NOT require a Temperature sensor.

Fig. C



Limiter Sensors (CT Sensors)

- Install sensors on incoming electrical service wires on L1 and L2 (see Diagrams Section)
- Limited To Home Mode (meter zero) and Peak Shaving Modes require CT sensors
- To ensure the sensors will fit, please check the wire size before ordering
- See pg. 39 for additional CT sensor information.

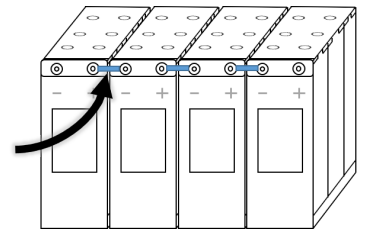
GEN Start Signal (Two-Wire)

- The signal comes from a normally open relay that closes when the Gen Start state is active

CANbus & RS485

- To connect batteries to the Sol-Ark 12K via RJ45, you need to splice the end connecting to the Sol-Ark 12K
- Use the middle two conductors
- RS485 is SunSpec draft 4 (will not work with draft 3)

Wi-Fi Antenna (Dongle)

Remote monitoring and software updates require an internet connection through the Wi-Fi dongle

Emergency Stop Signal & PV Rapid Shutdown Signal

Pins 11 and 12 use a normally open & latching switch to connect the two emergency stop pins that cut off the RSD power supply when triggered, thus stopping the inverter AC output.

Pins 15 and 16 provide the 12V / 100mA signal power lost when the Sol-Ark shuts down using the front button.

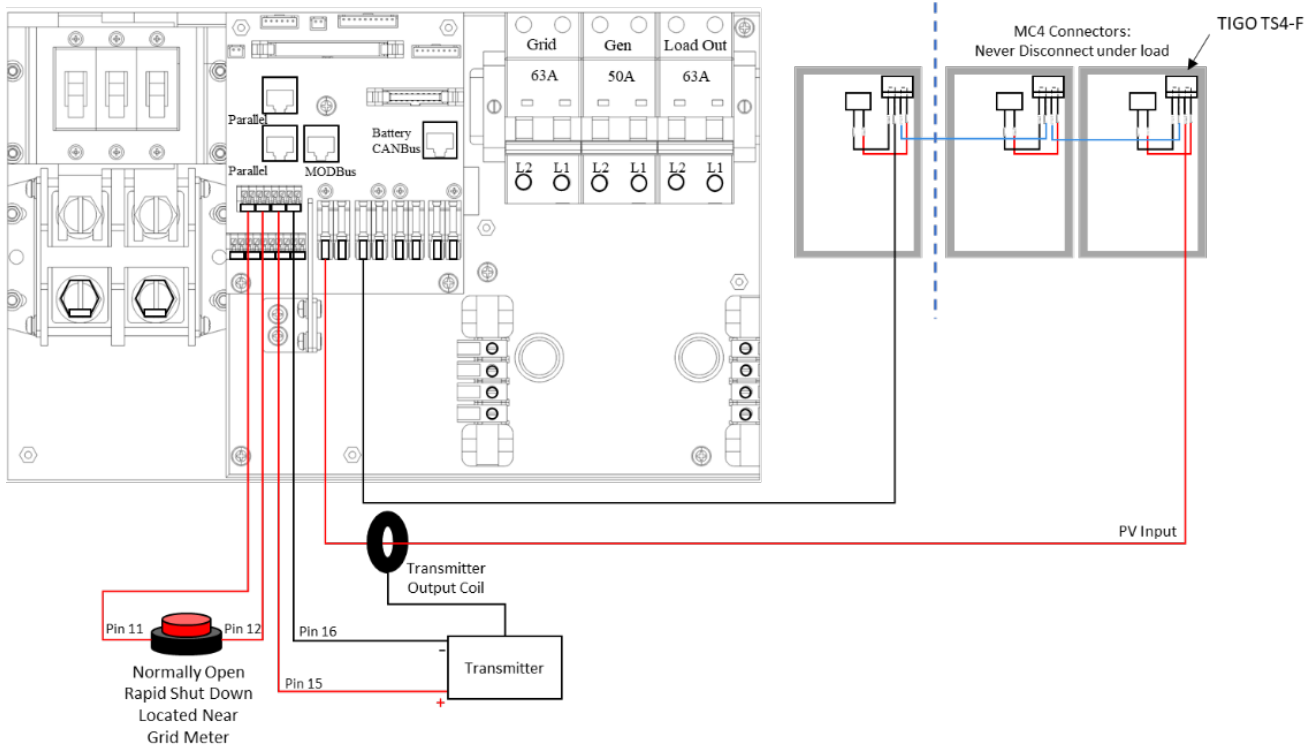

Emergency Stop Diagram (Only available on select hardware versions | Shown with TIGO TS4)

Rapid Shutdown: TIGO TS4-A-O | TIGO TS4-A-F | TIGO TS4-O | TIGO TS4-O-DUO | APsmart RSD S-PLC / RSD-D

PARALLEL SYSTEMS: Emergency Stop should be connected to the Master with address 01 and will initiate emergency stop for all paralleled systems from the one button



- The Built-in 12V power supply in the user area of the Sol-Ark (Pins 15 and 16) is rated for 100mA (1.2W)
- Transmitter fits inside the user area of the Sol-Ark 12K but can cause interference (sometimes requires placing it outside of the user area)
- TIGO Optimizers are compatible with the Sol-Ark 12K (Do not use the built in 12V Power supply in the Sol-Ark user area to Power the Tigo Optimizer TX transmitter)

Misc. Hardware Recommendations

Disconnect / Transfer Switches: 200A Non-Fused Transfer Switch Model #TC10324R (GE) | 200A Fused Transfer Switch Model #DG224NRK (Eaton)

PV Fuses: 15A PV MC4 in-line fuse holder (ZOOKOTO or DPJ)

Electrical Panel: Any appropriately rated panel for your loads (Check local hardware stores for recommendations)

Battery Combiners (Parallel Systems Only): Any appropriately rated pair of Bus Bars with 3/8" battery connection terminals

Powering-Up and Testing the Sol-Ark 12K

Check the voltage on each PV input circuit

- A. It should be no higher than 500Voc Temp. corrected
-  **B. DO NOT connect PV+ OR PV- to GND**
- C. Verify polarity (backward polarity shows 0V)

Check Grid Input Voltage

- A. Measure L1 to Neutral and L2 to Neutral. Ensure 120Vac
- B. Measure L1 and L2 Ensure 240Vac
- C. Check Neutral and Ground are ~0V AC
- D. Verify L1 voltage on AC in/out is 0Vac with the primary L1 connection in the panel. Same for L2

Check Battery Voltage

- A. Turn on the battery switch (if using a Lithium battery)
- B. Turn on the built-in battery disconnect in the user area
- C. The voltage should be 45Vdc-60Vdc

Provide Power to Sol-Ark

- A. Turn on Grid Breaker and Load Breaker
- B. Turn the PV disconnect switch to the "ON" position
- C. Press the ON/OFF Button on the front, and the blue light should turn on

Indicator LED's

DC

- A. Green = DC Solar Panels are producing
- B. Off = Solar Panels are not producing

AC

- A. Green = Grid (or Gen or AC Coupled) is Connected
- B. Off = grid is not Connected

Normal

- A. Green = Sol-Ark 12K is working properly
- B. Off = Sol-Ark 12K is not working properly

Alarm

- A. Red = Alarm, check the alarms menu
- B. Off = No alarms



Turn ON with one of three sources of power:
1) PV 2) Grid 3) ON/OFF Battery

Power Cycle Sequence

1. Turn on the Built-In battery disconnect
2. Make sure that Sol-Ark 12K is properly connected to the batteries, panels, grid, etc. (see system wiring diagram).
3. Turn on grid power breakers.
4. Press the power button on the front of the unit.
5. Make sure Solar panel inputs are not connected to Ground, then Turn on DC disconnect switch.
6. Turn on load breakers.
7. Reverse the steps to turn off

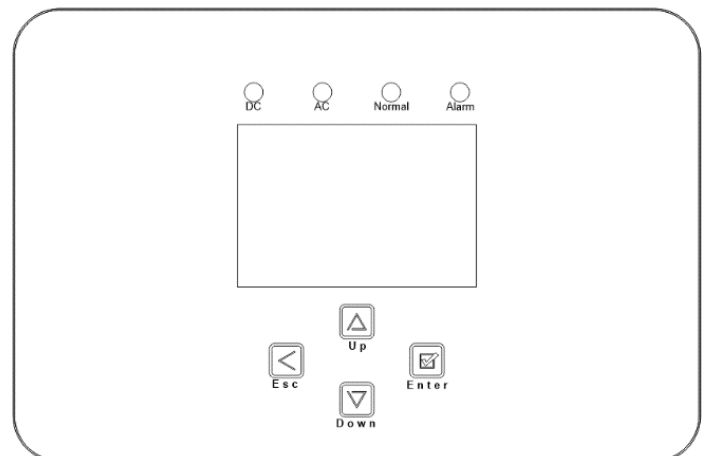

Remote Monitoring Setup

Ethernet Dongle

- Open the dongle enclosure and thread the ethernet cable through the hole, and plug it into the RJ45 port
- Reassemble the dongle housing and plug dongle into Sol-Ark, and secure it with screws
If all is well, you will see solid red and green lights
- Register the dongle via the app or www.mysol-ark.com

Wi-Fi (Via Cell Phone or computer)

- Plug the Wi-Fi dongle into Sol-Ark
- Using your device, look for an "EAP" network containing the last five (5) digits of the dongle S/N
- Password: 12345678
- Follow the instructions on the upcoming pages



You can access PowerView on a computer with the following link:

<http://www.mysol-ark.com>



Download PV Pro App



iPhone: (Will only show up as PV Pro)
<https://apps.apple.com/lk/app/power-view-pro/id1247121391>



Android
https://play.google.com/store/apps/details?id=com.elinter.app.powerview&hl=en_US&gl=US



Attention Installers

If you plan to add an install to your installer account for monitoring multiple installs, you must first make the plant under the **customer's** account.

Once created, the customer can share the plant, with **Manager permissions**, to the installer via the app ("..." under My Plants) or webpage (press the "..." next to the plant name in Power View).

PV Pro App
Tutorial Video



PV Pro Website
Tutorial Video



Create an Account and Sign In

Account login

Please input your E-mail

Password

SIGN IN

Sign Up | Forgot Password

Sign Up

E-Mail Phone Number

Please input E-mail

Please input verification code GET CODE

Password

Click [CONFIRM], you agree and are willing to comply [\(Terms of Service\)](#)

SIGN UP

After filling the form click "Create Account"

Account login

Please input your E-mail

Password

SIGN IN

Sign Up | Forgot Password

Add a Plant

Plant Name

Create Plant

0 Online 0 Warning 0 Fault 0 Total

Create time Efficiency

No Data

Plants Equipment Event Me

Scan the QR code on the dongle while plugged in

ETH + Wi-Fi Stick
P/N: ETH-0200-01
S/N: 1440 030 320
C/P: CHU-890-VNA-V01E

Ethernet + Wi-Fi Stick (89)

Please put QR Code in the box

Manual input On

Create Plant

SN E#####

Key #####

Plant Information

Plant Name* TEST

Plant photos

Installed Capacity* 10 kWp

Operating Date* 2021-03-25

Installer Sol-Ark

Address* 5833 Curtis Rd Parker

Time zone* (UTC-6:00)Central Time (US & Cana...)

Plant Type* Energy Storage (DC coupling)

Income information

Currency* \$

On Plant Type, ALWAYS select Energy Storage (DC coupling).

Make sure to pick a unique plant name. (I.E. "Last Name, First four of Address")

Connect the System to the Internet

If Wi-Fi paired with 10.10.10.1, select Done

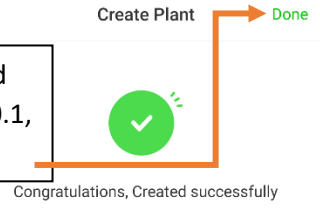

Congratulations, Created successfully

DISTRIBUTION NETWORK

You can click the confirm button in the upper right corner to complete the creation or to configure the network for the collector

Select Distribution Network to pair Dongle with WIFI

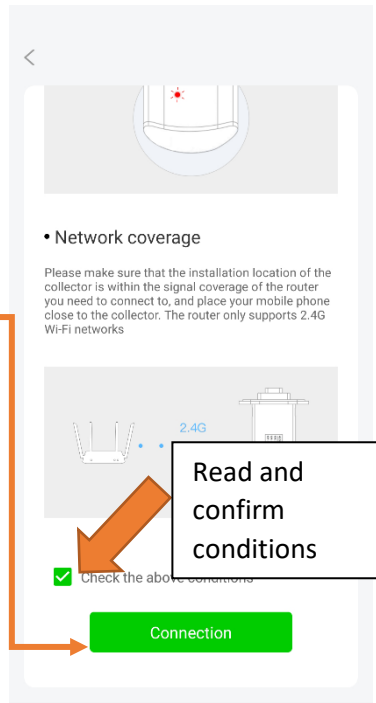

Read and confirm conditions

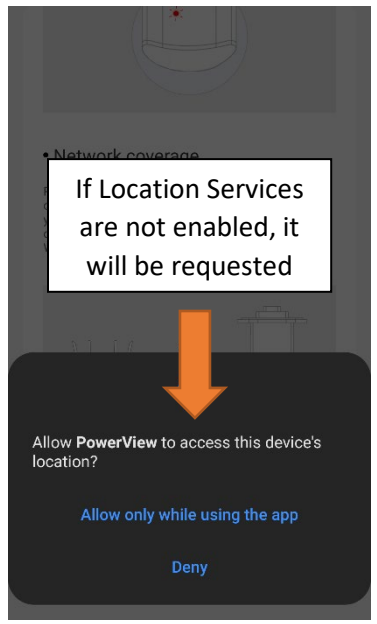

If Location Services are not enabled, it will be requested

Allow PowerView to access this device's location?
Allow only while using the app
Deny

Once you see this screen, go to your **DEVICE'S** Wi-Fi settings and connect to the Wi-Fi network that starts with:
EAP-#####
Password: "12345678"
Return to app once connected

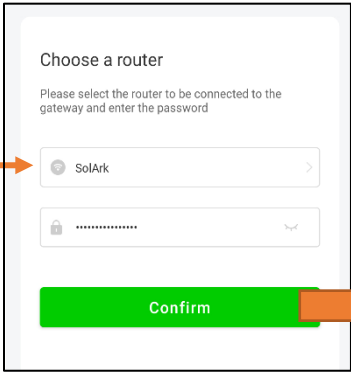

Select the local Wi-Fi network that will be providing the internet connection to the system
Do NOT select the dongle's Wi-Fi network

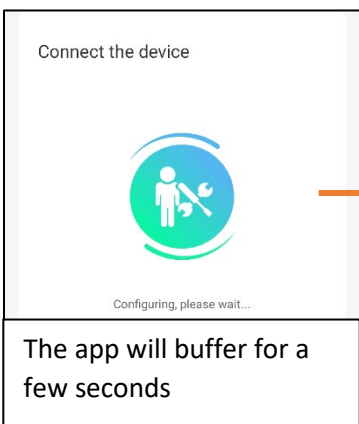

The app will buffer for a few seconds

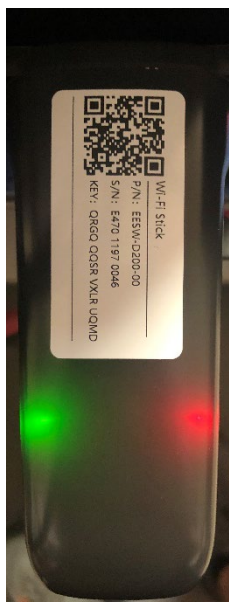

It takes about 60sec for the lights to turn on after setup
Red LED: Connected to Sol-Ark and has power
Green LED: Connected to Internet and Server
Flashing Green LED: Connected to router but not server (usually a VPN or firewall issue)

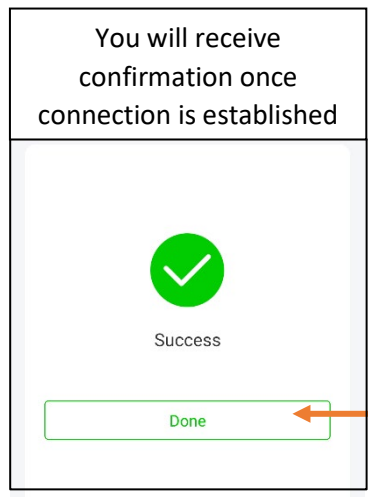

You will receive confirmation once connection is established

Start Monitoring The Data

Select your plant

This screen is the real time view

Alarms

Graphed data

System info and programming



Attention

If you are installing **parallel** systems, **DO NOT** create a plant for each inverter.

Create one plant for the **Master** unit and then use the browser version of PowerView (mysol-ark.com).

Click on the “...” for the **MASTER’s** plant and hit “Add Gateway” then put the S/N and Key of the **SLAVE’s** dongle.

IP Address Setup Instructions (PC or Smart Phone)



Please Note that this method only achieves internet connectivity. For registration and account management please use the app and/or www.mysol-ark.com

Connect to the Dongle Network

A. Settings → Wi-Fi → Select the Network with EAP- ##### (The last 5 digits of your SN number)

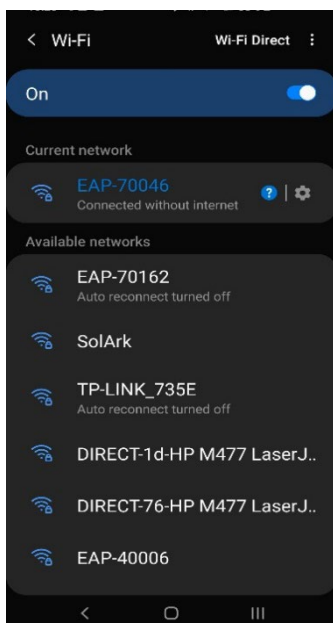

Password: 12345678

***Disclaimer*:** The Wi-Fi dongle does not have internet; You still need to be connected to the dongle for this process.

Login to Web Portal using ANY Search Browser

- Open Google or Safari → type in the search bar: **10.10.10.1**
- Scroll Down to "Wi-Fi Connection"
- Press "Scan" to search local networks

Select Your HOME Network

- Find the home network
- Enter personal Wi-Fi Password
- DO NOT SELECT DONGLE NETWORK**
- Select "Connect"

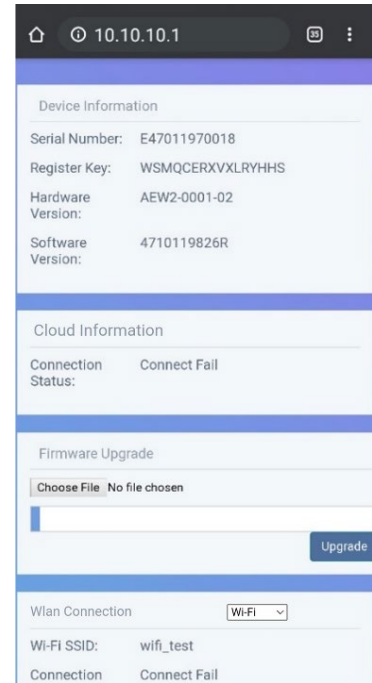
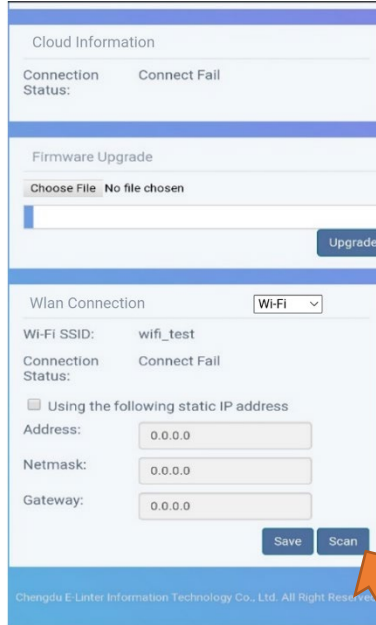
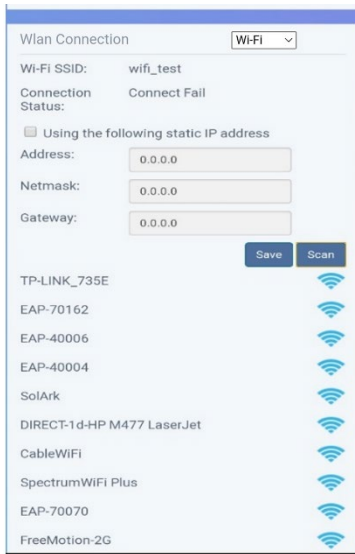

Disclaimer
 Connecting the dongle via the IP address only connects the dongle to the internet
YOU MUST STILL CREATE AN ACCOUNT VIA THE POWER VIEW APP

Save Your Information

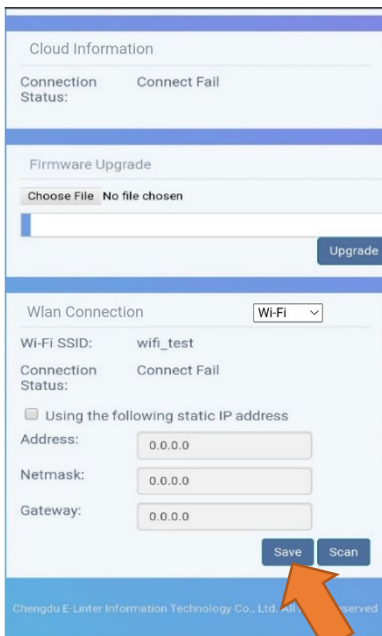

If Successful you should see a Red and Green light on the Dongle showing a successful connection.

- Red LED:** Connected to Sol-Ark and has power.
- Green LED:** Connected to Internet and Server
- Flashing Green LED:** Connected to router but not server (usually a VPN or firewall issue)



Main Menus

Solar Today=53KWH Total=559.8KWH

System Setup
1/25/2021 03:05:27 PM Mon.

Solar	Grid	INV	USP LD	Batt
3882W	-3081W 60.0Hz	3702W 60.0Hz	621W 122V	-26W
L1: 263V	126V	122V	0W	54.70V
5.4A	HM: -786W	15.2A	121V	-0.53A
1398W	LD:-1876W	1857W	640W	25.0C
L2: 264V	122V	121V	Gen	TEMP
9.5A	HM:1142W	14.8A	4V 0.0Hz 0W	DC: 55.0C
2484W	LD:1205W	1845W		AC:49.7C

Basic Setup

System Alarms

Battery Setup

Li-Batt Info

Only w/ BMS Lithium Mode

Sol-Ark 5k/8k/12k-P
 - ID: ##### SD
 - COMM: ####
 - MCU: Ver####

System Alarms 1/25/2021 03:05:27 PM Mon.

Alarms Code	Occurred
F13 Grid_Mode_changed	2021-01-13 11:22
F13 Grid_Mode_changed	2021-01-13 11:20

0.00 V	0.00 A	0.0 C	0%	0 Ah
0.0 V	0.0 V	0A	0A	0x00 0x00

Only w/ BMS Lithium Mode

1. 0.00V	0.00A	0.0C	0.0%	0.0V	0.0A	0 0 0
2. 0.00V	0.00A	0.0C	0.0%	0.0V	0.0A	0 0 0
3. 0.00V	0.00A	0.0C	0.0%	0.0V	0.0A	0 0 0
4. 0.00V	0.00A	0.0C	0.0%	0.0V	0.0A	0 0 0
5. 0.00V	0.00A	0.0C	0.0%	0.0V	0.0A	0 0 0
6. 0.00V	0.00A	0.0C	0.0%	0.0V	0.0A	0 0 0
7. 0.00V	0.00A	0.0C	0.0%	0.0V	0.0A	0 0 0
8. 0.00V	0.00A	0.0C	0.0%	0.0V	0.0A	0 0 0
9. 0.00V	0.00A	0.0C	0.0%	0.0V	0.0A	0 0 0
10. 0.00V	0.00A	0.0C	0.0%	0.0V	0.0A	0 0 0
11. 0.00V	0.00A	0.0C	0.0%	0.0V	0.0A	0 0 0
12. 0.00V	0.00A	0.0C	0.0%	0.0V	0.0A	0 0 0
13. 0.00V	0.00A	0.0C	0.0%	0.0V	0.0A	0 0 0

Basic Setup

Basic Setup

Display | Time | Advanced | Factory Reset | Parallel

Brightness

Auto Dim 600S

Beep

CANCEL OK

Basic Setup

Display | Time | Advanced | Factory Reset | Parallel

AM/PM Year 2021 Month 10 Day 26

Time Sync PM Hour 03 Minute 04 Second 15

Seasons Start M-D Season1 1 - 1 Season2 4 - 1 Season3 8 - 1

CANCEL OK End M-D 4 - 1 8 - 1 12 - 1

Basic Setup

Display | Time | Advanced | Factory Reset | Parallel

Solar Arc Fault ON Clear Arc_Fault

Gen Limit Power 9000W

Load Limit Power 9000W

Grid peak-shaving Power 9000W

Auto detect Home Limit Sensors CT ratio 2000

UPS Time 0ms

CANCEL OK

ARC parameters
030000
045000
000400
000050
000390
000055
238094

Basic Setup

Display | Time | Advanced | Factory Reset | Parallel

Factory Reset System selfcheck

Lock out all changes Test Mode

Lock Grid Charging & Limited

CANCEL OK

Basic Setup

Display | Time | Advanced | Factory Reset | Parallel

Parallel Master Modbus SN 00 Phase A

Slave Phase B

Meter > Grid Meter > Load Phase C

Meter Select No Meter

CANCEL OK

Battery Setup

Batt Setup

Batt | Charge | Discharge | Smart Load

Batt Capacity: 200Ah Use Batt V Charged

Max A Charge: 100A Use Batt % Charged

Max A Discharge: 185A No Battery

TEMPCO: -0mV/C/Cell BMS Lithium Batt 00

Activate Battery

CANCEL OK

Batt Setup

Batt | Charge | Discharge | Smart Load

StartV: 49.0V | 49.0V | Float V: 54.8V

Start%: 30% | 30% | Absorbtion V: 55.5V

A: 40A | 100A | Equalization V: 55.5V

30 Days: 0.0 Hours

Gen Charge Grid Charge

Generator Exercise Cycle Day & Time: Mon 08 :00 20min

Gen Force CANCEL OK

Batt Setup

Batt | Charge | Discharge | Smart Load

Shutdown: 46.0V | 20% | Batt Resistance: 25mOhms

Low Batt: 47.5V | 30% | Batt Charge Efficiency: 99.0%

Restart: 52.0V | 40%

Batt Empty V: 47.0V BMS_Err_Stop

CANCEL OK

Batt Setup

Batt | Charge | Discharge | Smart Load

Use gen input as load output For AC Coupled Input to Gen

On Grid always on High Frz: 62.00Hz

Smart Load OFF Batt: 51.0V | 80% AC couple on load side

Smart Load ON Batt: 54.0V | 90%

Solar Power(W): 500W

CANCEL OK

Grid Setup

Grid Param

Limiters | Sell Control | Grid Input | FreqVolt | PowFac

Time	Power(W)	Batt	Charge	Sell
01:00AM	2000	50%		
05:00AM	2000	50%		
09:00AM	2000	100%		
01:00PM	2000	100%		
05:00PM	2000	50%		
09:00PM	2000	50%		

CANCEL OK

Time of Use Setup

Mon. Tues. Wed. Thur.

Fri. Sat. Sun.

Season1 Season2 Season3

CANCEL OK

Grid Param

Limiters | Sell Control | Grid Input | FreqVolt | PowFac

General Standard

UL1741 & IEEE1547

UL1741SA

Grid Reconnect Time: 60s

Power Factor: 1.000

GEN connect to Grid Input

Zero Export Power: 20W

Batt First Load First

CANCEL OK

Grid Param

Limiters | Sell Control | Grid Input | FreqVolt | PowFac | Relay

Grid Frequency: 50Hz 60Hz

Grid Type: 220V Single Phase 120/240V Split Phase 120/208V 3 Phase

Protect Param: Grid Vol High: 270V, Grid Vol Low: 185V, Grid Hz High: 65.0Hz, Grid Hz Low: 55.0Hz

CANCEL OK

Grid Param

Limiters | Sell Control | Grid Input | FreqVolt | PowFac

L/HVRT L/HFRT

HF	LF
HV2: 252.0V 0.16S	HF2: 62.00Hz 0.16S
HV1: 231.0V 12S	HF1: 60.50Hz 299S
LV1: 184.8V 20S	LF1: 58.50Hz 299S
LV2: 147.0V 10S	LF2: 57.00Hz 0.16S
LV3: 105.0V 0.16S	

CANCEL OK

Grid Param

Limiters | Sell Control | Grid Input | FreqVolt | PowFac

Q(V) FW VW

V	Q	RT
V1: 216.0V	Q1: 0.44	RT: 5.0s
V2: 225.6V	Q2: 0.00	RT: 10s
V3: 254.4V	Q3: 0.00	
V4: 264.0V	Q4: 0.44	

Response Time: 10s

Normal Ramp rate: 10.0%/s

Soft Start Ramp rate: 10.0%/s

CANCEL OK

Sol-Ark Menus

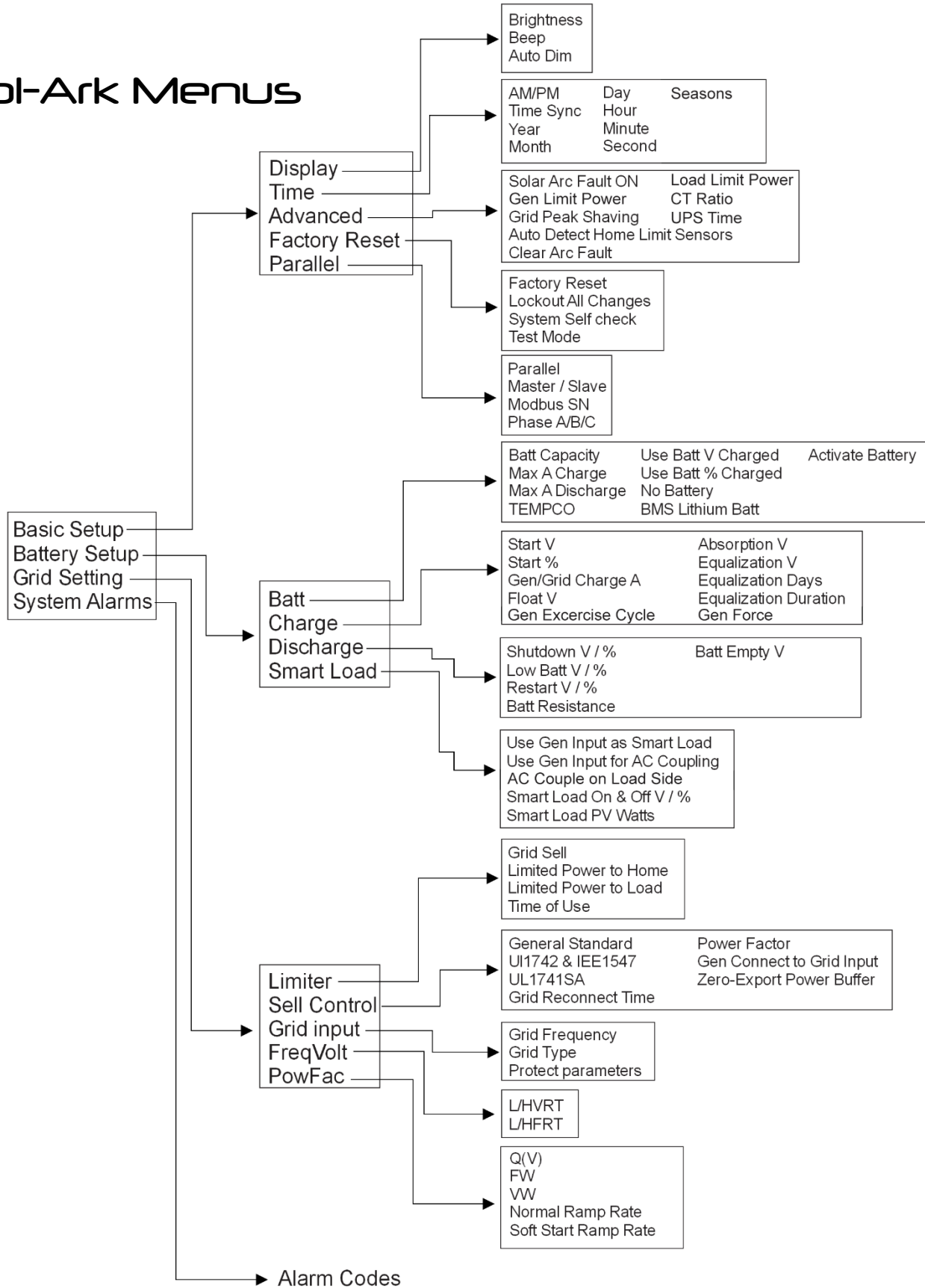

Main Screens (Touchscreen)

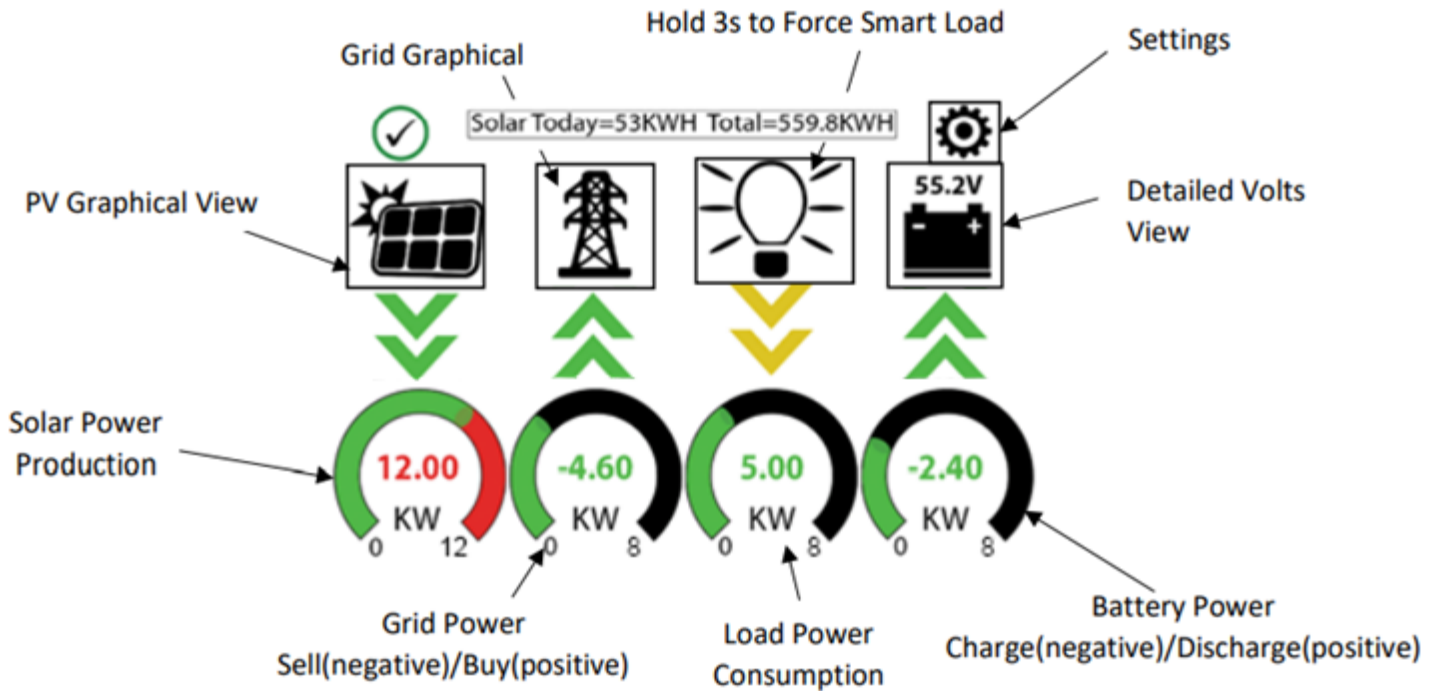

Detailed Volts View

- Top row = Total power for column
- Middle Row = Line 1/PV1 voltage, Amps, and Watts
 (note: PV Voltage not to exceed 500V)
- Bottom Row = Line 2/PV2 voltage, Amps, and Watts
 (note: PV Voltage not to exceed 500V)
- Batt Temperature will show -20°C if the temperature sensor is not connected. Batt SOC % = % batteries are charged
- DC Temp = Temperature of DC conversion electronics
 - Batt → AC
 - PV → Batt
 - AC → Batt
- AC Temp = Temperature of AC conversion electronics
 - Batt → AC
 - PV → AC
- Grid Column
 - If selling to the Grid, Grid Watts = negative
 - If buying from the Grid, Grid Watts = positive
 - HM = power detected by the external current sensors on the entire home L1 & L2
 - LD = power detected using internal sensors on AC grid in/out breaker

Solar	Grid	INV	USP LD	Batt
3882W	-3081W 60.0Hz	3702W 60.0Hz	621W 122V	-26W
L1: 263V 5.4A	126V HM: -786W	122V 15.2A	0W 121V	54.70V -0.53A
1398W	LD:-1876W	1857W	640W	25.0C
L2: 264V 9.5A	122V HM:1142W	121V 14.8A	Gen 4V 0.0Hz 0W	TEMP DC: 55.0C AC:49.7C
2484W	LD:1205W	1845W		



Note: Reversed Grid Watt values may indicate incorrectly installed current sensors (reversed polarity). See Page 38.

PV Graphical View

- Displays power production over time for the PV array
- Use up/down buttons to navigate between days
- Month view, Year view, and Total view

Grid Graphical View

- Displays power drawn from and sold to the grid over time
- Bars above the line indicate power bought from the grid
- Bars below the line indicate power sold back to the grid

This view can help determine when the peak power is used in the Home and for Time of Use Programming

System Setup Menu

- ID = LCD serial #. Support uses the Wi-Fi serial #.
- COMM = LCD software version
- MCU = Inverter software version

Basic Setup

Display

- Brightness adjustment
- Auto dim (must be enabled for the warranty to cover the LCD screen)
- Enable/disable BEEP

Time

- Set the date and time for the system
- Set up to 3 seasons for Time of Use to follow

Load Limit Power

Set the total AC Output of the Sol-Ark; excess power will be curtailed. The default value is always the Maximum output of the Inverter.

Grid Peak Shaving

Set the Sol-Ark's threshold to begin contributing power to keep the power drawn from the grid below the threshold.

CT Ratio

Set the CT ratio; the Default value is 2000/1. **DO NOT** change this value unless you speak with support; 3rd party CT sensors require our permission not to void the warranty.

UPS Time

Set the UPS transfer time to the chosen value; any value below 4ms will default back to a 4ms transfer time.

Parallel (connecting multiple systems)

- Select parallel mode when using more than one system
- Set the Master/Slave status of each system
 - Label only one system as the "Master"
- Set the MODBUS address of each system starting at 01
- When using multiple Systems in 120/208V mode, select which phase each system is responsible for (A, B, C) (see pg.

System Alarms

- Lists all recorded System alarms in chronological order

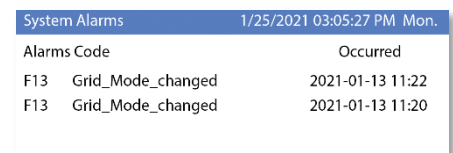
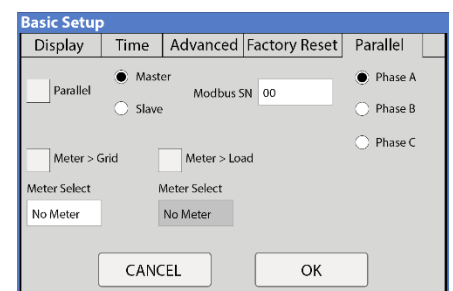
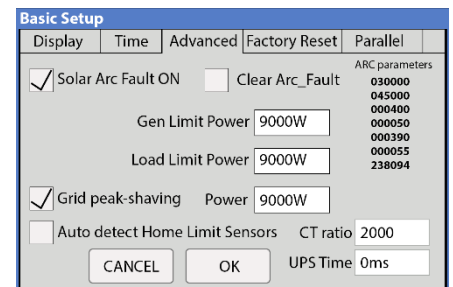
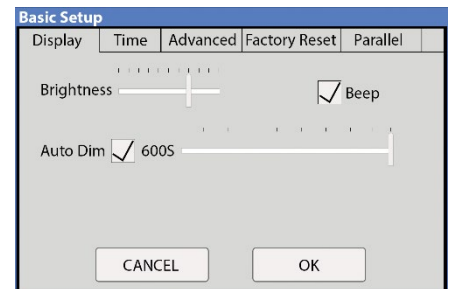
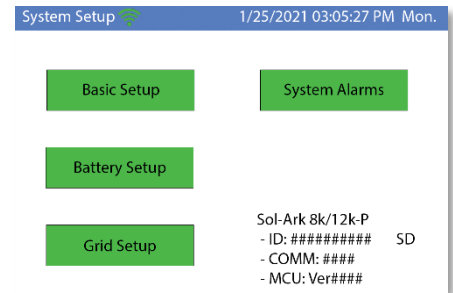

Battery Setup

Batt

Batt Capacity: enter the size of the battery bank connected to the system. Series = add Voltage | Parallel = add Amp-Hours

Max A Charge: set the max charge rate for the batteries (This also sets PV → Battery charge rate)



Suggest 20%-30% of battery capacity for lead-acid

Max A discharge: set max discharge for battery bank (In off-grid mode, the battery bank will discharge 120% of this value for 10 seconds before the Inverter shuts down to prevent battery damage)

TEMPCO: Temperature coefficient used in conjunction with the batt temp sensor to adjust optimal voltages for lead-acid batteries

Use Batt V Charged: displays battery charge in terms of voltage

Use Batt % Charged: Battery voltage can be misleading for determining the % Charged. So, we use algorithms measuring power in and out to measure a true value for % Charged. It compensates for aging batteries also.

Charge

Float V: Set value appropriate for the batteries connected to the system

Absorption V: Set value suitable for the batteries connected to the system

- Absorption will stop at 2% of the capacity of the battery bank and drop to float
- Ex: 400Ah battery would be 8A

Equalization V: Set value appropriate for the batteries in use.

Days: the period between equalization cycles

Hours: period taken to equalize batteries



Note if Hours = 0 system will not equalize the batteries

Gen Charge: uses the gen input of the system to charge the battery bank from an attached generator.

Start V: voltage at which the system will AutoStart a connected generator to charge the battery bank

Start percentage: Percent S.O.C at which system will AutoStart a corresponding generator to charge the battery bank

A: Charge rate from the attached Generator in Amps (DC). **Size this value according to the generator size**

Grid Charge: uses Grid input to charge batteries from the grid or generator

Gen Force: Test function for Gen AutoStart. Enable to trigger two-wire start (pins 15/16) and turn on the generator; disable to disengage two-wire start and turn off the generator. Generator will not provide power during this test if grid power is available.

Gen Exercise Cycle (Day & Time): Set a weekly Gen exercise schedule. (Day of the week/Time/Duration Length)



Gen must have two-wire start connected to Sol-Ark. To disable the exercise, set the duration length to 0 min.

Discharge

Shutdown V: battery voltage at which the Inverter will shut down (battery symbol on the home screen will turn red)

Low Batt: Low battery voltage (battery symbol on the home screen will turn yellow)

Restart: battery voltage at which AC output will resume

Batt Resistance: used in % SOC batt calculations

Batt Charge Efficiency: used in % SOC batt calculations

Batt Empty V: sets reserve capacity and improves % SOC calculations. It is not Batt_I adjusted

Batt	Charge	Discharge	Smart Load
Shutdown	46.0V	20%	Batt Resistance: 25mOhms
Low Batt	47.5V	30%	Batt Charge Efficiency: 99.0%
Restart	52.0V	40%	
Batt Empty V	47.0V		<input type="checkbox"/> BMS_Err_Stop



(Recommendations: 45V for AGMs, 48V for Lithium Iron Phosphate)

Smart Load (Gen Breaker)

- This mode utilizes the Gen input connection as an output that only receives power when the battery exceeds a user-programmable threshold.
- Enable "Use gen input as load output" to power high-power loads such as a water heater, irrigation pump, AC unit, pool pump, etc.

Smart Load OFF Batt

Battery voltage at which the Gen Load will stop receiving power

Smart Load ON Batt

Battery voltage at which the Gen Load will start receiving power

Batt	Charge	Discharge	Smart Load
<input checked="" type="checkbox"/> Use gen input as load output		<input type="checkbox"/> For AC Coupled Input to Gen	
<input checked="" type="checkbox"/> On Grid always on		High Frz: 62.00Hz	
Smart Load OFF Batt: 51.0V / 80%		<input type="checkbox"/> AC couple on load side	
Smart Load ON Batt: 54.0V / 90%			
Solar Power(W): 500W		CANCEL OK	



Using Gen load for a water heater, we recommend that only one leg (120V) be connected to the bottom element. This significantly reduces the power consumption of the water heater while retaining core functionality (it will heat water, only slower).



Gen Load is limited to 50A at 240V (Do not exceed!)

Solar Watts is for on Grid

- The system waits to turn on the smart load until enough PV power is produced (when on the grid)

AC Coupling Settings (" For AC Coupled Input")

- To use the Gen input breaker as an AC coupled input, check the "For AC Coupled Input" box (this feature will also work with "Grid-Tied" Inverters)
- The meaning of Smart Load OFF Batt and Smart Load ON Batt change in this mode

Smart Load OFF Batt: The SOC at which the AC coupled inverter(s) are shut down when in off-grid mode



90% recommended

Smart Load ON Batt: The SOC at which the AC coupled inverter(s) are turned on when in off-grid mode



60%-80% recommended

Maximum combined input (AC+DC) = 16kW

- Best: 3kWAC + 13kWDC
- Good: 5kWAC + 11kWDC
- OK: 8kWAC + 8kWDC
- Poor: 9.6kWAC + 6.4kWDC



When On-Grid, the AC-coupled Inverter will always be on, selling any extra power back to the grid.

AC Coupled PV Arrays will not work WITHOUT grid sell enabled (while the grid is available).

To use the LOAD breaker for AC coupling grid-tied Inverter (s)

- i. You must select "For Micro Inverter Input"
- ii. The Gen Breaker is not used (even though the GEN breaker is not physically being used for this mode, AC coupling on the LOAD breaker prevents the use of the GEN breaker)
- iii. Wire as shown in the preceding example diagram labeled "Load side AC coupling example"



Some load-side AC coupling installations will require a line side tap instead of the 50A breaker shown in the example diagram

Grid Setup

Limiter

Grid Sell: maximum watts sold to the grid

Limited To Home: Limits power produced by the system to match the demand of the Home

Limited To Load: Limits power produced by the system to match the demand of connected loads

Time Of Use:

Time: When the System will sell batt/PV power to the Grid or Home

Power(W): Max watts called from the battery only at each time

Batt: The battery voltage or % at which the system will limit selling to the Grid or Home from the battery. The system will drain the battery until reaching that percent/voltage.

Charge: Enables grid/gen charging up to the voltage or percentage specified on the line during a selected period. PV will always charge 100%. If using a generator, select the charge box for the times that may need the generator, and the Gen will charge the battery to the voltage or percentage specified in the "Batt" column.

Sell: The sell check box allows for discharging the battery for grid sell-back for that time slot

Grid Param						
Limiter	Sell Control	Grid Input	FreqVolt	PowFac	Relay	
<input type="checkbox"/>	Grid Sell	08000	Time	Power(W)	Batt	Charge
			01:00AM	2000	50%	<input type="checkbox"/>
<input type="checkbox"/>	Limited Power to Home		05:00AM	2000	50%	<input type="checkbox"/>
<input type="checkbox"/>	Limited Power to Load		09:00AM	2000	100%	<input type="checkbox"/>
			01:00PM	2000	100%	<input type="checkbox"/>
<input type="checkbox"/>	Time of Use	Setup	05:00PM	2000	50%	<input type="checkbox"/>
			09:00PM	2000	50%	<input type="checkbox"/>
CANCEL		OK				



Note: This Mode requires grid sell / limited to home / peak shaving be enabled.

Note: If you need the batteries to never charge from the grid, **uncheck** the "Grid Charge" box under the charge tab of the battery menu.

Sell Control

General Standard: uses Protect Parameters in table

UL 1741 & IEEE1547: Enables sell compliant functionality

UL1741SA: Enables wider Freq, Voltage, and Power Factor

GEN connect to Grid Input: Enable if Generator connects to the AC Grid breaker

Zero Export Power: Power drawn from the grid at all times

Grid Param	
Limiter	Sell Control
<input type="checkbox"/>	General Standard
<input type="checkbox"/>	UL1741 & IEEE1547
<input type="checkbox"/>	UL1741SA
	Grid Reconnect Time 300s
	Power Factor 1.000
	<input type="checkbox"/> GEN connect to Grid Input
	Zero Export Power 20W
	<input type="checkbox"/> Batt First <input type="checkbox"/> Load First
CANCEL	
OK	

Grid Input

Grid Frequency: Select the Grid Frequency connection

Grid Type:

- **220V Single Phase (Call us before using)**
- **120/240V Split Phase (North America)**
- **120/208V 3 Phase**

Protect Parameters: (when Settings when the system will connect/disconnect from the grid. UL 1741 & IEEE1547 do not use these parameters.



We recommend widening the frequency range when connecting a generator to the grid breaker (55-65Hz)

Grid Param					
Limiter	Sell Control	Grid Input	FreqVolt	PowFac	Relay
		Grid Frequency <input type="checkbox"/> 50Hz <input type="checkbox"/> 60Hz	Protect Param		
			Grid Vol High	<input type="text" value="228V"/>	
			Grid Vol Low	<input type="text" value="185V"/>	
		Grid Type	Grid Hz High	<input type="text" value="62.0Hz"/>	
		<input type="checkbox"/> 220V Single Phase	Grid Hz Low	<input type="text" value="57.0Hz"/>	
		<input type="checkbox"/> 120/240V Split Phase			
		<input type="checkbox"/> 120/208V 3 Phase			
			<input type="button" value="CANCEL"/> <input type="button" value="OK"/>		



If 120/208V, the L1 and L2 are phase specific. So, you may have to swap Grid L1 L2 for 208V applications.
Inverter power cycle is required each time the input/output voltage is changed

Selecting Power Mode

Sol-Ark 12K will simultaneously use various power sources available to meet loads demand. The following power modes allow the user to determine the power sources available to the Sol-Ark 12K.

Limited Load / Self Consumption

- Sol-Ark will only power loads connected to it.
- It will not produce more power than the connected loads require.
- This mode will neither sell back to the Home nor Grid.

Limited To Home (Zero-Metering)

Main Menu → System Settings → Grid Setup → Limiter → Limited to Home

- Pushes power to the whole Home without selling back any excess to the grid (no net metering agreement required)
- This mode requires the use of the limiter sensors
- Power source priority is the same as Grid Sell Back

Grid Sell

Main Menu → System Settings → Grid Setup → Limiter → Grid Sell

- This mode allows Sol-Ark 12K to sell back any excess power produced by the solar panels to the grid.

Power source priority:

- Solar Panels | 2. Grid | 3. Generator (Manual) | 4. Batteries (until reaching programmable % discharge)

Time Of Use (using batteries during peak power times)

Main Menu → System Settings → Grid Setup → Limiter → Time Of Use

- Use the batteries to reduce power consumption from the grid during a user-programmable peak pricing time.

Power source priority:

- Solar Panels | 2. Batteries (programmable % discharge) | 3. Grid (control when Grid charges) | 4. Generator

Grid Param						
Limiter	Sell Control	Grid Input	FreqVolt	PowFac	Relay	
<input checked="" type="checkbox"/>	Grid Sell	08000				
			Time	Power(W)	Batt	Charge
<input type="checkbox"/>	Limited Power to Home		01:00AM	2000	49.0V	<input type="checkbox"/>
<input type="checkbox"/>	Limited Power to Load		05:00AM	2000	49.0V	<input type="checkbox"/>
<input type="checkbox"/>			09:00AM	2000	49.0V	<input checked="" type="checkbox"/>
<input type="checkbox"/>			01:00PM	2000	49.0V	<input checked="" type="checkbox"/>
<input checked="" type="checkbox"/>	Time of Use	Setup	05:00PM	2000	49.0V	<input checked="" type="checkbox"/>
<input type="checkbox"/>			09:00PM	2000	49.0V	<input type="checkbox"/>
			<input type="button" value="CANCEL"/> <input type="button" value="OK"/>			

Simultaneously select Grid Sell and Limited to Home

Load (light bulb) icon on the home screen now includes both the load breaker power and the home's consumption.

FreqVolt (UL 1741SA must be enabled in "Sell Control" tab)

Puerto Rico Grid Compliance Settings:

Grid Param			
Limiter	Sell Control	Grid Input	FreqVolt
<input checked="" type="checkbox"/> L/HVRT		<input checked="" type="checkbox"/> L/HFRT	
HV2: 288.0V	0.16S	HF2: 61.50Hz	10S
HV1: 264.0V	1S	HF1: 60.50Hz	300S
LV1: 211.2V	2S	LF1: 59.20Hz	300S
LV2: 144.0V	1S	LF2: 57.50Hz	10S
LV3: 108.0V	0.16S		
CANCEL		OK	

Kauai Grid Compliance Settings:

Grid Param			
Limiter	Sell Control	Grid Input	FreqVolt
<input checked="" type="checkbox"/> L/HVRT		<input checked="" type="checkbox"/> L/HFRT	
HV2: 288.0V	0.16S	HF2: 64.00Hz	0.16S
HV1: 264.0V	5S	HF1: 63.00Hz	20S
LV1: 204.0V	20S	LF1: 57.00Hz	20S
LV2: 120.0V	0.16S	LF2: 56.00Hz	0.16S
LV3: 110.0V	0.16S		
CANCEL		OK	

Grid Param			
Limiter	Sell Control	Grid Input	FreqVolt
<input checked="" type="checkbox"/> Q(V)		<input checked="" type="checkbox"/> FW	<input type="checkbox"/> VW
V1: 225.6V	Q1: 0.44	Fstart: 60.10Hz	Vstart: 254.4V
V2: 232.8V	Q2: 0.00	Fstop: 62.40Hz	Vstop: 264.0V
V3: 247.2V	Q3: 0.00	RT: 0.5s	RT: 10s
V4: 254.4V	Q4: 0.44	Normal Ramp rate	100.0%/s
Response Time	10s	Soft Start Ramp rate	0.3%/s
CANCEL		OK	

HECO Grid Compliance Settings for O'ahu, Maui, Hawai'i:

Grid Param			
Limiter	Sell Control	Grid Input	FreqVolt
<input checked="" type="checkbox"/> L/HVRT		<input checked="" type="checkbox"/> L/HFRT	
HV2: 288.0V	0.16S	HF2: 64.00Hz	0.16S
HV1: 264.0V	1S	HF1: 63.00Hz	20S
LV1: 211.2V	20S	LF1: 57.00Hz	20S
LV2: 168.0V	10S	LF2: 56.00Hz	0.16S
LV3: 120.0V	0.16S		
CANCEL		OK	

Grid Param			
Limiter	Sell Control	Grid Input	FreqVolt
<input checked="" type="checkbox"/> Q(V)		<input checked="" type="checkbox"/> FW	<input type="checkbox"/> VW
V1: 225.6V	Q1: 0.44	Fstart: 60.10Hz	Vstart: 254.4V
V2: 232.8V	Q2: 0.00	Fstop: 62.40Hz	Vstop: 264.0V
V3: 247.2V	Q3: 0.00	RT: 0.5s	RT: 10s
V4: 254.4V	Q4: 0.44	Normal Ramp rate	100.0%/s
Response Time	10s	Soft Start Ramp rate	0.3%/s
CANCEL		OK	

HECO Grid Compliance Settings for Lana'i and Moloka'i:

Grid Param			
Limiter	Sell Control	Grid Input	FreqVolt
<input checked="" type="checkbox"/> L/HVRT		<input checked="" type="checkbox"/> L/HFRT	
HV2: 288.0V	0.16S	HF2: 65.00Hz	0.16S
HV1: 264.0V	1S	HF1: 63.00Hz	20S
LV1: 211.2V	20S	LF1: 57.00Hz	20S
LV2: 168.0V	10S	LF2: 56.00Hz	0.16S
LV3: 120.0V	0.16S		
CANCEL		OK	

Grid Param			
Limiter	Sell Control	Grid Input	FreqVolt
<input checked="" type="checkbox"/> Q(V)		<input checked="" type="checkbox"/> FW	<input type="checkbox"/> VW
V1: 225.6V	Q1: 0.44	Fstart: 60.10Hz	Vstart: 254.4V
V2: 232.8V	Q2: 0.00	Fstop: 62.40Hz	Vstop: 264.0V
V3: 247.2V	Q3: 0.00	RT: 0.5s	RT: 10s
V4: 254.4V	Q4: 0.44	Normal Ramp rate	100.0%/s
Response Time	10s	Soft Start Ramp rate	0.3%/s
CANCEL		OK	

PowFac

Power Factor is programmable from 0.8 – 1.0

CT Sensors enable Limited to Home mode (meter zero) and Peak Shaving mode. CT sensors also allow the system to calculate loads powered upstream of the Grid Breaker in the home.

CT Sensor Install Location

- CT sensors should be installed on L1 and L2 (also L3 for parallel 3 phase) upstream of everything in the home except for a Generator Transfer Switch, Knife Blade Disconnect or Bypass Transfer Switch (upstream of Main Service Panel and Line-Side Tap – see Diagrams Section Pgs. 8-16).

CT Sensor Size

- Each Inverter includes a pair of 5/8" CT sensors (fits up to 2/0 AWG service wires)
- There are 15/16" (up to 4/0 AWG) and 2" sensors available for purchase if needed
- Dimensions refer only to CT sensor hole size. Contact Sales at (972) 575-8875 Ext 1 to purchase larger sensors

CT Sensor Extension Example

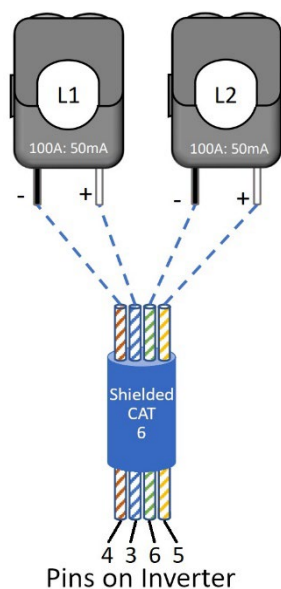

CT Sensor Wiring

- CT sensor on L1 should be wired to pins 3 (white) and 4 (black)
- CT sensor on L2 should be wired to pins 5 (white) and 6 (black).
- White and black wires for each sensor should be twisted along the length of run
- If needed, extend wires using Shielded Cat 6 (use both wires of twisted pair)

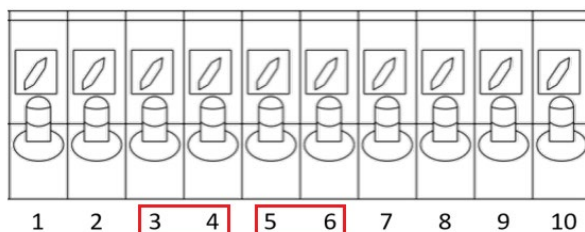

CT Sensor Direction

- There is an arrow embossed on the CT sensor housing to determine the direction
- Install pointing upstream to the service meter, **EXCEPT** in 3-phase installs where this should be reversed

Peak Shaving Mode

- Grid Peak Shaving is available with the CT sensors in the location described above and the applicable direction

CT Ratio

Set the CT ratio; the Default value is 2000/1. **DO NOT** change this value unless you speak with technical support. 3rd Party CT sensors require our permission not to void the warranty.

Parallel 120V/240V Split Phase Note

- Each Inverter will come with a pair of CT sensors
- Only install one pair and wire it to the master inverter
- CT sensors should be installed with the system in Limited to Home mode for the best operation

Parallel 120V/208V 3-Phase Note

- Each Inverter will come with a pair of CT sensors.
- Install only one sensor per phase, wire sensor for L1 and L2 to Phase A Master.
- Install the third sensor on L3 and wire to Phase B master pins 5 (+ white) and 6 (- Black).
- Point the arrow on CT sensors downstream toward the inverters (3-phase only).

Limiters Sensor Automatic Setup

Requires Batteries, AC coupled panels must be off while detecting polarity, and it does NOT work for 208V installs. If you do not have batteries or are in 208V mode: verify CT sensor placement manually.

- Install limiter sensors as previously described (shown in all diagrams as well). Battery and grid connections are also required before starting auto-setup.
- Navigate to the "Advanced" Tab of the Basic Setup screen (follow the directions below to get there)
 - Touch the gear icon → Touch the Basic Setup button → Select the Advanced tab (see Fig. C)
- Select "Auto detect Home Limit Sensors" and press "OK"
- Wait for the Sol-Ark to finish its learning process (Sol-Ark will alternate sell back between legs and magnitude automatically determining the correct settings for the sensors)
- Verify sensors were correctly configured (see Fig. D) if they are not correct, repeat the learn function

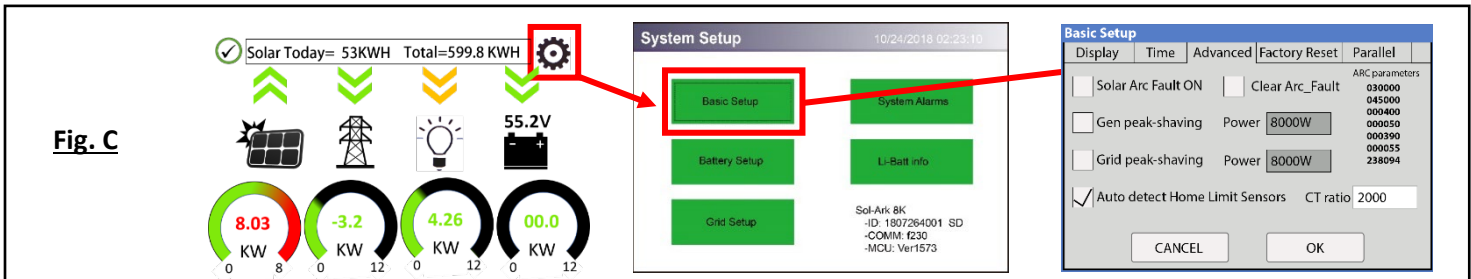

Fig. C

Fig. D

In Limited To Home Mode HM values will be close to zero. HM values should never be negative. If negative, the Limiter Sensors are not installed properly.

	Solar	Grid	INV	USP LD	Batt
	3882W	-3081W	3702W	621W	-26W
		60.0Hz	60.0Hz	122V	
L1: 263V		126V	122V	0W	54.70V
5.4A		HM: -786W	122V	121V	-0.53A
1398W		LD: -1876W	1857W	640W	25.0C
L2: 264V		122V	121V	Gen	TEMP
9.5A		HM: 1142W	14.8A	4V	DC: 55.0C
2484W		LD: 1205W	1845W	0.0Hz	AC: 49.7C
				0W	

Possible Limiter Sensor issues:

- Sensors are facing wrong direction
- Sensors are on the wrong wire(s)
- Sensors are not fully closed on wire(s)
- Sensor Polarity is wrong (White = + BLK = -)



Verifying proper sensor direction:

- Any loads in the home will show a positive HM (+) value in Watts
- Turning on solar panels and enabling Grid Sell should show a negative HM (-) in Watts if you are producing more power than the loads are consuming
- If you turn on limited power to Home mode, then HM: ~0 Watts to zero the meter (system matches the loads to within 99%)



If you installed limiter sensors (CTs) for Limited To Home selling mode, verifying the proper sensor placement and direction is critical. Remove one sensor from the main L1 connection, and the power should drop to 0W.

Off-Grid Install Tips

Sol-Ark 12K will automatically operate in Off-Grid Mode without the grid (under the same power priority as TOU).

- A. Limiter Sensors are not required for completely Off-Grid installs unless using Grid Peak Shaving with a Gen connected to the Grid input breaker.
- B. The Grid input breaker on the Sol-Ark should be used as the Generator input (4-30kW generators) so that you may maintain Smart Load output capability when off-grid. Therefore, you will use Grid Charge (default) in the Battery Setup/Charge menu to enable the generator's ability to charge the batteries.
- C. When off-grid, there is no need for a transfer switch: connect the load output of the Sol-Ark to the whole home.
- D. Do not use Grid Sell or Limited To Home Modes Off-Grid. Only Limited power to load (default).
- E. The Auto Generator start functions as a 2-wire switch (closes the circuit when needing charging)
 - i. Auto Gen-start will be triggered when the battery voltage or percent reaches the level programmed in the battery setup menu. Then, the generator will continue to charge the batteries until they are about 95% full (this percentage is not programmable) before turning the generator off.
 - ii. When using the Sol-Ark to control a generator, an exercise function will turn on the generator once a week on Monday mornings at 8 AM

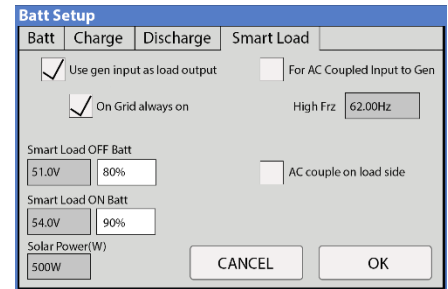

- F. We recommend changing the "Grid Reconnect Time" under the Sell control tab of the grid setup menu to 30 seconds; otherwise, the Sol-Ark will not charge from the generator until it has been on for at least 5 minutes per the default value of 300 seconds.
- G. Under setup for Grid/Sell Control, select General Standard and "GEN connect to Grid Input." Then go to Grid input to widen the input frequency range to 55-65Hz to work with any frequency generator.
- H. If you would like to use a wind turbine in conjunction with the Sol-Ark 12K, the turbine must have a 48V charge controller with a dump load to prevent overcharging the batteries. Connect the charge controller on the turbine to the battery bank the Sol-Ark uses, and the turbine will help charge the batteries.
- I. Don't forget to set the Battery capacity and reasonable charge rates.

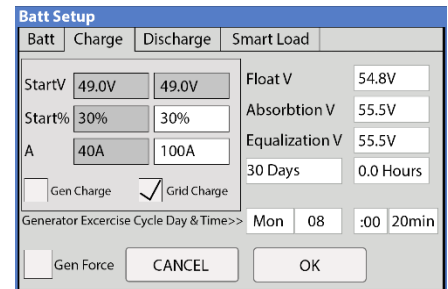

Grid-Tie / No Battery Install Tips

- A. Under Battery setup, select no Battery & disable Activate Battery (or the system will beep).
- B. Note: a whole system power cycle is required when changing the battery to no battery settings.
- C. Under Grid Setup, select Grid Sell.
- D. Touch the Battery Icon to see the Detailed Volts View to verify your inputs & outputs.

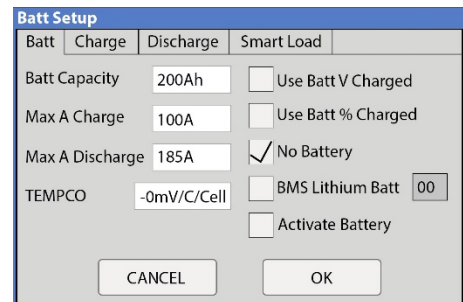

Solar	Grid	INV	USP LD	Batt
3882W	-3081W 60.0Hz	3702W 60.0Hz	621W 122V	-26W
L1: 263V 5.4A 1398W	126V HM: -786W LD:-1876W	122V 15.2A 1857W	0W 121V 640W	54.70V -0.53A 25.0C
L2: 264V 9.5A 2484W	122V HM:1142W LD:1205W	121V 14.8A 1845W	Gen 4V 0.0Hz 0W	TEMP DC: 55.0C AC:49.7C

Battery Charging Information

4-Stage Charging

The MPPT has a 4-stage battery charging algorithm for rapid, efficient, and safe battery charging. The figure below shows the stage sequence.

Bulk Charge Stage

In the Bulk Charge stage, the battery is not at a 100% state of charge and has not yet reached the Absorption voltage setpoint. The controller will deliver 100% of available solar power to recharge the battery.

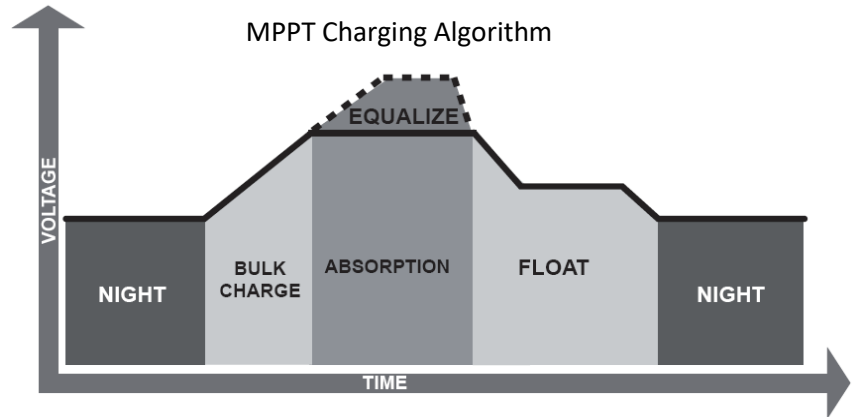

Absorption Stage

When the battery has reached the absorption voltage setpoint, we use constant-voltage regulation to maintain battery voltage at the absorption setpoint, preventing heating and excessive battery gassing. The battery is allowed to come to a full state of charge at the absorption voltage setpoint. Absorption lasts until batteries charge at 2% of the programmed Ah size.

Float Stage

After the Absorption stage charges the battery fully, the MPPT reduces the battery voltage to the float voltage setpoint. If batts have 100% charge, there can be no more chemical reactions, and all the charging current turns into heat and gassing. The float stage provides a meager rate of maintenance charging while reducing the heating and gassing of a fully charged battery. The purpose of float is to protect the battery from long-term overcharge.

Battery Charging Setpoint Examples (48V)

Battery Type	Absorption Stage	Float Stage	Equalize Stage (every 30 days 3hr)	Default
AGM / PCC	14.4v (57.6v)	13.5v (53.6v)	14.4v (57.6v)	
Gel	14.1v (56.4v)	13.5v (54.0v)		
Wet	14.7v (59.0v)	13.7v (55.0V)	14.7v (59.0v)	
Lithium	14.1v (54.6v)	13.2v (54.3v)	14.1v (54.6v)	



- Batteries in series:
ADD VOLTAGES
- Batteries in parallel:
ADD AMP-HOURS

Calculating Battery Bank's Amp-Hours (PCC 230)

Battery Count	Voltage / Battery	Amp Hours / Battery	Total Amp Hours @48V	Max Charge/ Discharge Amp
4	12V	230Ah	230Ah	100A
8	12V	230Ah	460Ah	185A
12	12V	230Ah	690Ah	185A
16	12V	230Ah	920Ah	185A

Sol-Ark PCC-230 Battery

Batt Capacity: 230Ah x #Parallel_Batteries
 (1 parallel = 4 Batt in series, 2 = 8 Batt, 3 = 12 Batt, 4 = 16 Batt)
 Max A Charge: 100A x #Parallel_Batteries
 Max A Discharge: 100A x #Parallel_Batteries
 Max A Grid Charge: 50A x #Parallel_Batteries
 TEMP CO: -5mV/C/Cell
 Float V: 53.6V
 Absorption V: 57.6V
 Equalization V: 57.6V
 Equalization Days: 30
 Equalization Duration: 3 Hours
 Recommended Shutdown V / Percentage: 47.0V & 20%
 Recommended Low Batt V / Percentage: 47.5V & 35%
 Recommended Restart V / Percentage: 52.0V & 50%
 Battery Resistance: 35mOhms (8 Batt) or 25mOhms (16 Batt)
 Battery Charge Efficiency: 99%
 Battery Empty Voltage: 45V

Time	Watts	SOC	GridCharge
1:00AM	1500*Par_Batts	70%	
5:00AM	1500*Par_Batts	70%	
9:00AM	1500*Par_Batts	70%	
1:00PM	1500*Par_Batts	100%	
4:00PM	1500*Par_Batts	70%	
9:00PM	1500*Par_Batts	70%	

These settings will charge the batteries off solar only. Discharge the batteries down to a maximum of 70% full.

Limited To Home mode will not sell to the grid from the batteries (only the home will use battery power). The 100% time slot is to ensure that the batteries are properly cycled each day.

MODBUS/RJ45 Application Note

BMS Lithium Batt Modes (Subject to Change):

00: CANBus Battery mode – Inverter also acts a ModBus slave with slave ID set by “ModBus SN Setting” (Pg. 32)

01: Storz ModBus Protocol

02: Pylontech ModBus Protocol

03: Old Blue Ion + eGauge / Polarium ModBus Protocol

04: Fortress Power ModBus Protocol

05: Kilovault HAB ModBus Protocol

06: Battery or Battery Controller is ModBus master and writes battery data to Inverter’s BMS registers (not currently in use).



Find our full list of currently supported battery communications
www.sol-ark.com/battery-partners

Our Battery Communications Integration Guide can also be found here
www.sol-ark.com/support

Use the information below at your own risk; the warranty will not cover any damage caused by the improper use of the communications protocols. Read-Only Modbus Map available upon request at support@sol-ark.com

Combined RS-485 and CANBus
Pin 1 or 8 is RS-485 B- (Data -)
Pin 2 or 7 is RS-485 A+ (Data +)
Pin 4 CAN High
Pin 5 CAN Low
Pin 6 is GND

Baud 9600
8bits data
One stop bit, no parity
Does not require termination

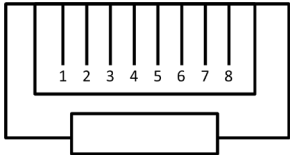

End View

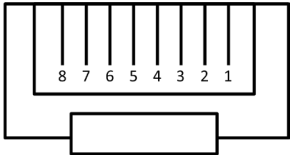

Looking Into Connector

Incorporating 3rd Party ModBus Devices:

If your device utilizes BMS Lithium Batt 00, you need to set the Inverter Modbus SN to 01. The default ModBus SN is 00.

If you have more than one Inverter then follow pg. 45 to ensure proper programming.

Before Enabling Parallel Operation

- A. Make sure all units in parallel have the same software version. Hardware version may also affect compatibility; Call or email Tech Support if you parallel indoor and outdoor units to verify.
 - a. Check the following screen to verify your firmware versions
 - b. Go to <https://www.sol-ark.com/software-update/> to schedule an update or call Tech Support for assistance
- B. Parallel systems **REQUIRE** a joint battery bank. If you do not have a battery, you can keep all Sol-Ark's out of parallel and set every System to Grid Sell Mode.
- C. Dipswitches must be set appropriately; see **fig. E & F**
 - a. 2 Inverters: All dipswitches in LEFT position.
 - b. 3 Inverters: Dipswitches in Modbus Address order (1-3): LEFT, RIGHT, LEFT
 - c. 6 Inverters: Dipswitches in Modbus Address order (1-6): LEFT, RIGHT, RIGHT, RIGHT, RIGHT, LEFT

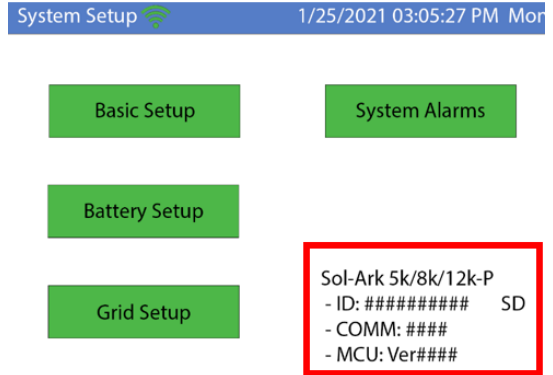

Fig. E – Dipswitch Location on 12K

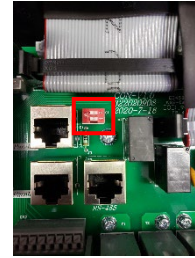
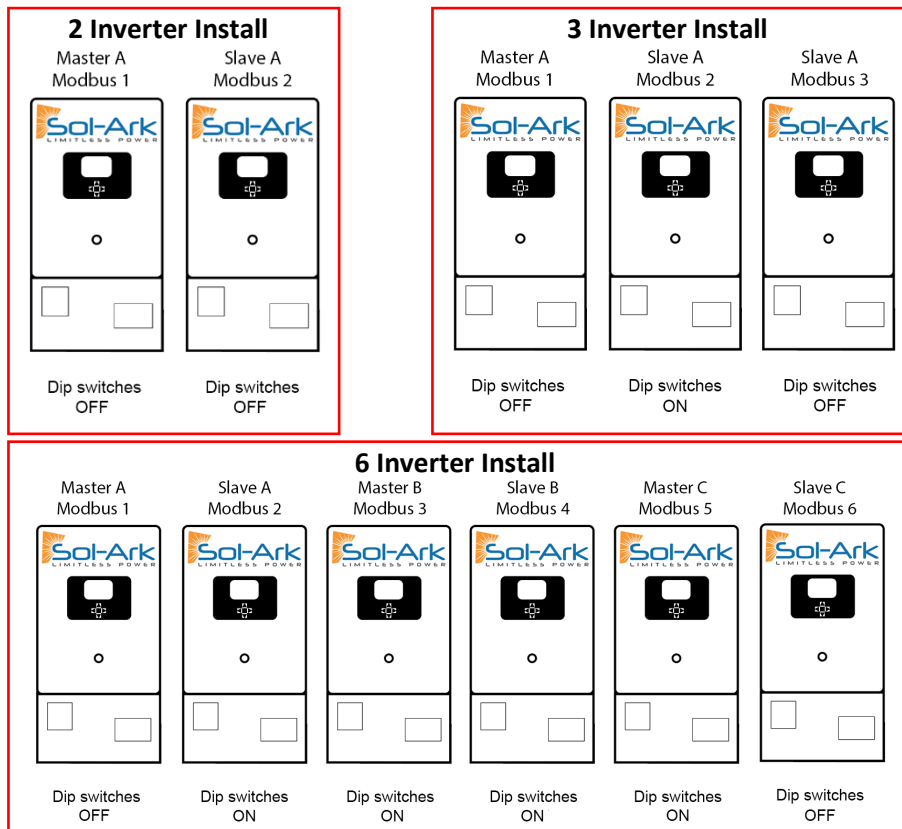

Fig. F – Dipswitch positions (OFF = Down | ON = Up)



- D. Suppose you cannot evenly divide the number of PV panels connected to each Inverter. In that case, we recommend having more PV panels on the master inverter(Master 01) / leading Inverter (Master 01 – Phase A).

Stacking Sol-Ark 12K @ 120V/240V Outputs

Parallel 12Ks	Continuous On & Off Grid (kW)	Pass-Through (kW)	Peak 10sec (VA)
1	9	15	16
2	18	30	32
3	27	45	48
4	36	60	64
5	45	76	80
6	54	91	96
7	63	106	112
8	72	121	128

Stacking Sol-Ark 12K @ 120V/208V Outputs (3-phase)

Parallel 12Ks	Continuous On & Off Grid (kW)	Pass-Through (kW)	Peak 10sec (VA)
1*	9	15	16
2**	18	30	32
3	27	45	48
4	NA	NA	NA
5	NA	NA	NA
6	54	91	84
7	NA	NA	NA
8	NA	NA	NA
9	81	136	144

*Two phases only **Three phases but unbalanced (4.8kW, 6.2kW, 4.8kW)

MUST wire load outputs in parallel for systems to work correctly!

- E. Communication lines must be connected between parallel units, as shown in the wire diagrams section
 - a. Preferred shielded CAT 6 cable for this purpose
- F. Program all units to "Parallel" in the "Basic Setup" screen under the "Parallel" tab
 - b. Set one system to "Master" | Modbus SN: 1
 - c. Set all others to "Slave" | Modbus SN: 2,3,4...
 - d. Phases B/C for 120V/208V installations only
 - e. Power up slaves first, then Master
 - i. You will get an F29 or F41 error until both slaves and Master are on



Note: You must always fully power cycle all inverters after enabling or disabling parallel settings. Check Pg. 24 for more info on Power cycling

- G. Ensure the Generator is connected to all systems in parallel (if applicable).



Note: The values shown on the home screen of each system represent each system's contribution, not the array's total.



Note: All units will shut down if an error or fault occurs on any unit. They will automatically attempt to restart up to 5 times before requiring a manual restart. If a manual restart is necessary, first resolve the issue that caused the shutdown. A manual restart requires powering down the system (See Pg. 24).

- Systems = 1 @ 208V
 - Master Ph A Modbus=1: Inv_L2 = **Grid_L2** || Inv_L1 = **Grid_L1**
 - Power to Grid: 4.5KW x 2 Legs
- Systems = 2 @ 208V
 - Master Ph A Modbus=1: Inv_L2 = **Grid_L2** || Inv_L1 = **Grid_L1**
 - Master Ph B Modbus=2: Inv_L2 = **Grid_L3** || Inv_L1 = **Grid_L2**
 - 9KW x 2 Power to Grid: **4.2KW + 4.8KW** & **4.8KW + 4.2KW**
- Systems = 3 @ 208V
 - Master Ph A Modbus=1: Inv_L2 = **Grid_L2** || Inv_L1 = **Grid_L1**
 - Master Ph B Modbus=2: Inv_L2 = **Grid_L3** || Inv_L1 = **Grid_L2**
 - Master Ph C Modbus=3: Inv_L2 = **Grid_L1** || Inv_L1 = **Grid_L3**
 - 9KWx3 Power to Grid: **4.5KW + 4.5KW** & **4.5KW + 4.5KW** & **4.5KW + 4.5KW**

6 Systems @ 208V

Master Ph A Modbus=1		Slave Ph A Modbus=2
Master Ph B Modbus=3		Slave Ph B Modbus=4
Master Ph C Modbus=5		Slave Ph C Modbus=6

9 Systems @ 208V

Master Ph A Modbus=1		Master Ph B Modbus=4
Slave Ph A Modbus=2		Slave Ph B Modbus=5
Slave Ph A Modbus=3		Slave Ph B Modbus=6
Master Ph C Modbus=7		Slave Ph C Modbus=8
Slave Ph C Modbus=9		

3 System Install: Master Ph A (Top), Master Ph B (Middle), and Master Ph C (Bottom)

LCD is not powering on

- Check all connections- at least one of the following power sources is required: PV/Grid/Battery
- Try pressing the power button, touchscreen, or navigation buttons

Panels are connected, but DC Light is not on

- PV voltage must be 150V-425V | It's night

Panels are not producing

- Check for proper wiring on all solar panel connections
- Turn PV disconnect "ON"
- Check that the PV input voltage is not greater than 425V
- If the system says PV = 0V, check the PV polarity

Panels are not producing much power

- PV Wire Strip Length: 5/8". Your batteries are charged; you can test Grid Sell to verify.

The system does not keep batteries charged

- Check the charge setting in the Charge Menu

Auto Gen-Start is not working

- Check to make sure your generator is compatible with Auto Start
- Make sure that the Auto Gen Start wire is adequately connected to the Sol-Ark 12K and the generator

Normal LED isn't on

- Sol-Ark 12K is in pass-through-only mode, with only a Grid connection.
- Sol-Ark 12K is not working correctly (Call us)

The alarm light is on

- Check the system alarms menu to identify the alarm

Grid HM value is negative when it should be positive (only applies in limited home mode)

- Limiter Sensors are backward, L1/L2 sensors are swapped, or incorrectly wired L1/L2 sensors. Try Auto Learn.

AC Overload Fault or Bus Unbalance Fault

- Check Transfer Switch/Subpanel wiring
- Check for large loads that consume more than the inverter rating (EX: AC units over 3 tons)

The system connects to the grid and quickly disconnects

- With a DMM, verify your Neutral wire connection (should be 0 Vac referenced to GND)
- Check your Freq is set to 60Hz, and that the 12K measures 120V on L1 / L2 vs. N.
- If overloading: verify 120/240V grid input and load output wires are not swapped.
- If 120/208V, the L1 and L2 are phase-specific. So, you may have to swap Grid L1 / L2 for 208V applications.

DC Overload Fault

- Check PV voltage
- Make sure you have not wired more than two (2) solar strings in parallel

System is beeping

- Check the system alarms menu to see the triggered alarm. Most alarms will self-reset.
- There is no battery connected. If not using a battery, select no battery and disable Activate Batt in the Batt setup menu.
 - Turn off the center button, remove AC Grid and PV Power for the 30s (the screen is dead), and then power up to fully reset the system.

Battery cable sparks when connected

- Put the built-in battery breaker in the off position before connecting or disconnecting the batteries.

The battery symbol on the home screen is red

- The battery is under-Voltage or over-Voltage

The battery symbol on the home screen is yellow

- The battery is low, or the charge/discharge current is close to the programmed limit (which is ok)

The grid symbol on the home screen is yellow

- Grid parameters are out of specified range, or the grid is down

System has restarted

- It happens if the system is overloaded, the battery voltage is greater than 63V, or the Software updated

Batteries were connected backward

- The battery breaker will trip. It can cause damage!

Why is the LCD screen still on when the power button is off?

- If PV or Grid power, LCD stays on, but the Inverter and loads are off.

The Batt % meter is not reaching 100%

- The system needs to go through a small discharge/charge cycle first to calibrate the battery

The generator setup is reading 0 Hz

- Select "General Standard" instead of UL1741. Then widen the frequency range to 55Hz-65Hz.

Color Touchscreen is Frozen

- Press and hold the escape button [←] for 7-10 seconds

Constant F18 Faults while powering loads within specification

- Click the battery icon on the front of the Inverter and look to see what the AC Output voltage is:

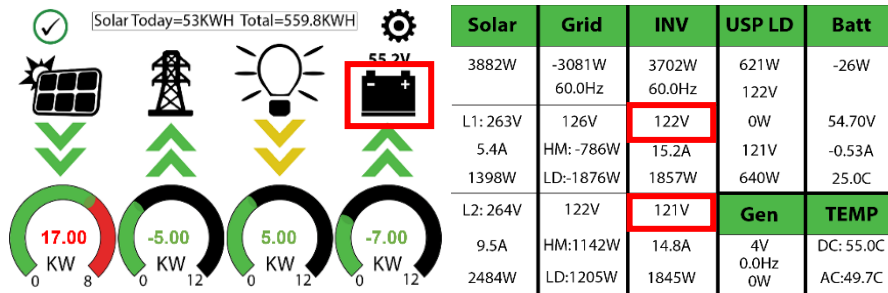

- If the AC Output Voltage is ~100V per leg (N/A in 220V single-phase grid mode), then check whether you are missing a neutral connection, have a loose neutral wire, or have a damaged neutral wire somewhere in your AC wiring.
- If the AC Output Voltage is ~120V per leg (N/A in 220V single-phase grid mode) and you have more than one Inverter in parallel, contact engineering support for further assistance.

Troubleshooting Phasing Issues

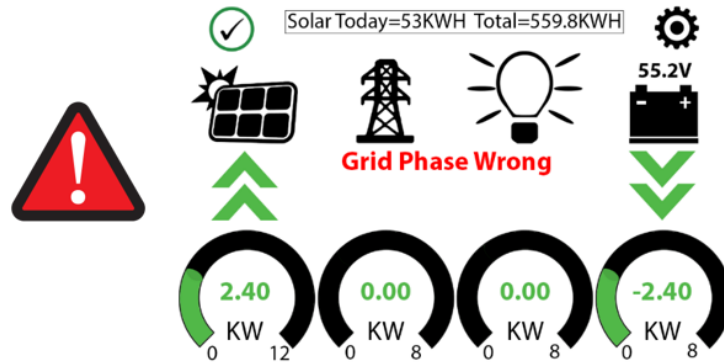

If the Sol-Ark screen shows **Grid Phase Wrong**, there is a phasing issue with your wiring, and it may cause overload faults (F18, F26, F34) even with the Load breaker **off** and **WILL CAUSE DAMAGE if left unchecked**.

Single Sol-Ark: To locate the improperly wired phases, measure **L1 to L1 (Top Screws)** between the **Grid** and **Load** breaker; you should see 0V AC. Repeat for **L2 to L2** between the **Grid** and **Load** breaker. Attempt to correct the wiring until you only read 0V AC between **L1 to L1 & L2 to L2**.

Parallel inverters: measure L1 of the **Grid** breaker to L1 of another unit's **Grid** breaker; you should see 0V AC. If in 208V parallel, measure the lines of the same wire color between sol-arks to see if you read 0V AC.

Make sure to correct both the Grid and Load wiring; they both need to be correct.

If the error persists, you will need to check your AC wiring beyond the Inverter and may also need to verify that the phases are properly labeled coming from your meter.

Remainder of Page Left Intentionally Blank

Sol-Ark 12K Error Codes

Fault	Instruction	Common Cause/Remedy
F1	DC Inversed Failure	If you have parallel systems and turn one system off, you will get this notification. NOT a fault.
F8	GFDI_Relay_Failure	Current Leakage from inverter AC output to Ground, check Ground and neutral are connected at the main panel
F13	Grid_Mode_change	It can happen when not using batteries or if Grid Input settings are changed. This is a notification, NOT a fault. If you switch from No Batt to Battery mode, power the system down completely to restart.
F15	AC_OverCurr_Failure	It is usually caused by Loads too large for the Inverter. If off-grid, the battery discharge amps are programmed too low. Overloads can result in F15, F18, F20, or F26.
F16	GFCI_Failure	Ground fault. Check PV+ or PV- wiring (which must be ungrounded). Exposed PV conductors + rain can also cause. Check that the neutral line and Ground are not double-bonded (common with portable generators).
F18	Tz_Ac_OverCurr_Fault	Overloaded the Load Output (reduce loads) or overloaded a generator (reduce Gen Start A see pg. 33). Wiring Short on the AC Side can also cause this error. Overloads can result in F15, F18, F20, or F26.
F20	Tz_Dc_OverCurr_Fault	It is typically caused by DC current from the battery that is too large (ex: 4 Ton AC Unit) or too much PV current (3 or more strings in parallel). Overloads can result in F15, F18, F20, or F26.
F22	Tz_EmergStop_Fault	Initiated Emergency Stop; see sensor pinout table.
F23	Tz_GFCI_OC_Fault	PV Ground fault. Check PV+ or PV- wiring (which must be ungrounded or damage can occur). Typically caused by pinched PV wire grounding the PV+ or PV-. Grounded PV wire can cause F20, F23, or F26.
F24	DC_Insulation_Fault	An exposed PV conductor combined with moisture is faulting (can cause F16, F24, F26).
F25	AC_Active_Batt_Fault	No battery connection to the Inverter, and Activate Battery is enabled. Disable Activate Battery in settings while no battery is connected.
F26	BusUnbalance_Fault	Too much load on one leg (L1 or L2) Vs. the other leg or DC loads on the AC output when off-grid. Grounded PV +/- wire can cause F20, F23, or F26.
F29	Parallel_CANBus_Fault	Usually, a communication error for parallel systems, check cables, and MODBUS addresses (pg. 44)
F30	AC_MainContactor_Fault	Contact Sol-Ark.com
F31	Soft_Start_Failed	Soft Start of the large motor failed
F34	AC Overload Fault	AC Overload or load shorted. Reduce heavy loads.
F35	AC_NoUtility_Fault	Grid connection lost
F37	DCLLC_Soft_Over_Cur	Software DC overcurrent
F39	DCLLC_Over_Current	Hardware DC overcurrent
F40	Batt_Over_Current	Batteries exceeded their current discharge limit
F41	Parallel_System_Stop	If one system faults in parallel, this normal fault will register on the other units as they disconnect from the grid
F45	AC_UV_OverVolt_Fault	Grid under voltage causes a disconnect. This will self-reset when the grid stabilizes.
F46	Parallel_Aux_Fault	Cannot communicate with other parallel systems. Check Master = 1, Slaves are 2-9, ethernet cables are connected.
F47	AC_OverFreq_Fault	Grid over Frequency (common in power outages) causes a disconnect. Will self-reset when grid stabilizes.
F48	AC_UnderFreq_Fault	Grid under Frequency (common in power outages) causes a disconnect. Will self-reset when grid stabilizes.
F55	DC_VoltHigh_Fault	PV may be higher than 500V. Battery voltage should not be above 59V or 63V (depending on the model).
F56	DC_VoltLow_Fault	Batteries are overly-discharged, the Inverter is off grid and exceeded the programmed batt discharge current by 20%, or Lithium BMS has shut down. If battery settings are incorrect, this can also happen.
F58	BMS communication fault	Sol-Ark is programmed to BMS Lithium Battery Mode but cannot communicate with a BMS
F60	Gen_Volt_or_Fre_Fault	Generator Voltage or Frequency went outside the allowable range
F61	Button_Manual_OFF	The parallel Slave system turned off without turning off the Master
F63	ARC_Fault	It can be a poor PV connector/connection. And sometimes a false alarm due to powerful lightning storms.
F64	Heatsink_HighTemp_Fault	Check that the built-in fans are running; the ambient temperature may be too high. Ensure proper clearance (pg. 6).

For the installer to complete AFTER the system is operational. The purpose is to protect the installer, homeowner, and Inverter.

1. Is the 12K installed in a location where the **LCD is protected from direct sunlight** and has 6" clearance left and right for cooling (12" between parallel systems)? Y/N
2. Are all the battery lugs tightened? Y/N
3. 12K should connect to the grid, 12K 63A load/Grid breakers ON, batteries connected, PV input on, and ON button on. With the Inverter running, the Backup load's panel and Grid-connected:
 - A. Did any breakers trip? Y/N
 - B. Did the inverter overload? Y/N
4. If you have problems, please take pictures of these and email them to: support@sol-ark.com
 - A. **Battery icon screen, showing detailed voltages (the screen shown below)**
 - B. **Sol-Ark 12K with batteries and also the user wiring area**
5. Load and solar test
 - A. Press the battery icon for the detailed voltages screen.
 - B. Is the batt temp sensor working? Y/N
 - C. Turn on many loads for the Backup circuits. Are solar panels producing enough power to match the load (provided there is enough sun)? Y/N
 - D. Program Full Grid Sell Mode. If there are enough panels and sun or light loads in the entire house, the Grid HM measurements will be negative on both L1/L2. Are they negative (solar selling back to the grid)? Y/N
 - E. Program limited power to home mode. The Grid HM sensors will be near zero or slightly positive. Are they both near zero and canceling out the whole home power? Y/N
 - F. You have verified the limit sensors are correctly installed. An auto-learn function corrects any mistakes in CT limiter wiring (provided you have batteries and in 120/240V). Program in the correct Grid mode the customer will use.
6. Did you program the correct Ah for the battery bank and max Amps charge/discharge? Y/N
7. Did you program the correct battery charge voltages for your battery type? Y/N
8. **Turn off the AC breaker so 12K operates in an off-grid mode for several minutes.** Are appliances still powered? Y/N
9. **Turn off the PV input, running only on batteries for several minutes.** Are appliances still powered? Y/N
10. Turn on the PV input and AC Grid inputs.
11. Did you set up the Wi-Fi plug to the customer's internet? Y/N
12. Absolutely important for software updates. Did you help the customer register system on Monitoring App? Y/N
13. Does the customer have a standby generator or a small portable Generator? Y/N
 - A. Did you turn off UL1741/IEEE1547 (use General Standard) and reprogram grid freq. range to 55-65Hz? Y/N
 - B. Did you enable Gen charging and adequately set the charge current if using a small gas generator on Gen inputs? Y/N
14. If EMP protected, did you install EMP Suppressors on essential appliance cords? Y/N



This checklist must be filled out and submitted to register your warranty. Please visit:
<https://www.sol-ark.com/register-your-sol-ark/>

Installer Name

Installer Signature

Date

Customer Name

Customer Signature

Date

10-Year Limited Warranty for SOL-ARK (Portable Solar LLC) Products. Sol-Ark provides a Ten-year (10) limited Warranty ("Warranty") against defects in materials and workmanship for its Sol-Ark products ("Product"). The term of this warranty begins on the Product(s) initial purchase date, or the date of receipt of the Product(s) by the end user, whichever is later. This must be indicated on the invoice, bill of sale from your installer. This warranty applies to the original Sol-Ark Product purchaser and is transferable only if the Product remains installed in the original use location. Please call Sol-Ark to let us know if you are selling your Home and give us name and contact of the new owner.

The warranty does not apply to any Product or Product part that has been modified or damaged by the following:

- ❖ Installation or Removal (examples: wrong voltage batteries, connecting batteries backward, damage due to water/rain to electronics, preventable damage to solar wires.)
- ❖ Alteration or Disassembly
- ❖ Normal Wear and Tear
- ❖ Accident or Abuse
- ❖ Unauthorized Firmware updates/software updates or alterations to the software code
- ❖ Corrosion
- ❖ Lightning: unless using EMP hardened system, then Portable Solar will repair the product
- ❖ Repair or service provided by an unauthorized repair facility
- ❖ Operation or installation contrary to manufacturer product instructions
- ❖ Fire, Floods, or Acts of Nature
- ❖ Shipping or Transportation
- ❖ Incidental or consequential damage caused by other components of the power system
- ❖ Any product whose serial number has been altered, defaced or removed
- ❖ Any other event not foreseeable by Portable Solar, LLC

Contact Us: 1-972-575-8875

For Info/Purchasing:
sales@sol-ark.com | ext.1

For Tech Support/Warranty Claim:
support@sol-ark.com | ext.2

For Administrative Help:
ext.3

Sol-Ark (Portable Solar LLC) liability for any defective Product, or any Product part, shall be limited to the repair or replacement of the Product, at Portable Solar LLC discretion. Sol-Ark does not warrant or guarantee workmanship performed by any person or firm installing its Products. This warranty does not cover the costs of installation, removal, shipping (except as described below), or reinstallation of Products or parts of Products. LCD screen and fans are covered for 5 years from date of purchase.

THIS LIMITED WARRANTY IS THE EXCLUSIVE WARRANTY APPLICABLE TO SOL-ARK (PORTABLE SOLAR LLC) PRODUCTS. SOL-ARK EXPRESSLY DISCLAIMS ANY OTHER EXPRESS OR IMPLIED WARRANTIES OF ITS PRODUCTS. SOL-ARK ALSO EXPRESSLY LIMITS ITS LIABILITY IN THE EVENT OF A PRODUCT DEFECT TO REPAIR OR REPLACEMENT IN ACCORDANCE WITH THE TERMS OF THIS LIMITED WARRANTY AND EXCLUDES ALL LIABILITY FOR INCIDENTAL OR CONSEQUENTIAL DAMAGES, INCLUDING WITHOUT LIMITATION ANY LIABILITY FOR PRODUCTS NOT BEING AVAILABLE FOR USE OR LOST REVENUES OR PROFITS, EVEN IF IT IS MADE AWARE OF SUCH POTENTIAL DAMAGES.

Return Policy - No returns will be accepted without prior authorization and must include the Return Material Authorization (RMA) number. Please call and talk to one of our engineers to obtain this number at 972-575-8875.

Return Material Authorization (RMA) A request for an RMA number requires all of the following information: 1. Product model and serial number; 2. Proof-of-purchase in the form of a copy of the original Product purchase invoice or receipt confirming the Product model number and serial number; 3. Description of the problem; 4. Validation of problem by Technical Support, and 5. Shipping address for the repaired or replacement equipment. Upon receiving this information, the Sol-Ark representative can issue an RMA number.

Any product that is returned must be brand new, in excellent condition and packaged in the original manufacturer's carton with all corresponding hardware and documentation. Returns must be shipped with prepaid freight and insured via the carrier of your choice to arrive back at Portable Solar within 30 days of your initial delivery or pick-up. **Shipping charges will not be refunded.**

All returns are subject to a 35% restocking fee. **No returns will be accepted beyond 30 days of original delivery.** The value and cost of replacing any items missing (e.g. parts, manuals, etc.) will be deducted from the refund. If you have any questions regarding our return policy, please email us at sales@sol-ark.com or call us at the number above during regular (M-F) business hours.

Sol-Ark 12K Install Operational Verification Checklist Questionnaire must be filled out, signed, and dated to secure full warranty coverage.