

COMP *A-I-R*™
Compressor Nebulizer

RE-C800KD
Instruction Manual

For Single Patient Use Only



Rx ONLY

All for Healthcare

Table of Contents

Introduction	2
Important Safety Information	3
1. Know Your Device	6
1.1 Contents	6
1.2 Names of the Parts	7
2. Preparation	8
2.1 Before Using the Device for the First Time	8
2.2 Cleaning the Device Before First Use	8
2.3 Setting the Device.....	10
3. Using Your Device	13
3.1 Starting Inhalation	13
3.2 Cleaning the Device After Each Use	16
3.3 Cleaning the Device Weekly	16
3.4 Changing the Air Filter	17
3.5 Storing the Device.....	18
4. Troubleshooting	19
5. Disposal	19
6. Optional Medical Accessories	20
7. Specifications	20
8. FCC Statement	23
9. Limited Warranty	24
10. Guidance and Manufacturer’s Declaration	25

Introduction

Thank you for purchasing the Omron® COMP A-I-R® RE-C800KD.

Omron Healthcare has advanced electronic nebulizer technology with the introduction of the COMP A-I-R RE-C800KD. With a focus on patient convenience and compliance as our goal, this small and lightweight device provides a quiet and effective treatment.

Safety Instructions

This instruction manual provides you with important information about the OMRON RE-C800KD. To ensure the safe and proper use of this device, READ and UNDERSTAND all of these instructions. If you do not understand these instructions or have any questions, contact 1-800-634-4350 before attempting to use this device. For specific information about your own respiratory health, consult with your physician.

Intended Use

The RE-C800KD Compressor Nebulizer System is intended to provide air to the pneumatic nebulizer in order to aerosolize medications for inhalation by the patient for respiratory disorders. It is designed for use with pediatric (3 year old and greater) and adult patients in the home, hospital, and sub-acute settings.

Receiving and Inspection

Remove this device from the packaging and inspect for damage. If this device is damaged, DO NOT USE and contact 1-800-634-4350.

Symbol Glossary

For symbol information, visit: OmronHealthcare.com/symbols-glossary

Important Safety Information

Read the Important Safety Information in this instruction manual before using this device.

Follow this instruction manual thoroughly for your safety.

Keep for future reference. For specific information about your own device, CONSULT WITH YOUR PHYSICIAN.

WARNING

Indicates a potentially hazardous situation which, if not avoided, could result in death or serious injury.

- Failure to properly clean the COMP A-I-R components may cause bacterial growth, serious illness from contamination, and compromised medication delivery.
- For type, dose, and regimen of medication, follow the instructions of your physician and/or licensed healthcare practitioner.
- DO NOT use Pentamidine with this device.
- If you experience any allergic reactions or other difficulties during use, stop using this device immediately and consult with your physician.
- Keep this device out of the reach of unsupervised infants, toddlers and children. This device contains small parts that may cause a choking hazard if swallowed by infants, toddlers or children.
- ALWAYS dispose of any remaining medication after use. ALWAYS use fresh medication for each treatment.
- DO NOT use this device on persons who are unconscious or not breathing on their own.
- DO NOT use only water in the nebulizer for inhalation purposes.
- DO NOT use this device where it may be exposed to flammable gas or vapors.
- DO NOT use or store this device in humid locations such as a bathroom.
- DO NOT leave this device or its parts in locations that are exposed to extreme temperature or humidity changes such as in a vehicle or in direct sunlight.
- DO NOT use in anesthetic or ventilator breathing circuits.
- Clean the parts of this device before using this device for the first time, and also when the device has not been used for an extended period of time.
- Clean the parts of this device after each use.
- After cleaning, allow the parts to dry before reassembling. To avoid contamination, store the device and parts in a clean and safe location.
- DO NOT immerse the main unit or the AC adapter in water or other liquid.
- DO NOT spill water or other liquids, including medications, on the main unit or the AC adapter.
- DO NOT leave the cleaning solution on the parts. Rinse the parts with clean tap water after cleaning.
- Store this device and the components in a clean, safe location.

AC Adapter Handling and Usage

- DO NOT use the AC adapter if this device or the AC adapter cable is damaged. If this device or the cable is damaged, turn off the power and unplug the AC adapter immediately.
- Plug the AC adapter into the appropriate voltage outlet. DO NOT use in a multi-outlet plug.
- NEVER plug in or unplug the AC adapter from the electric outlet with wet hands.
- DO NOT disassemble or attempt to repair the AC adapter.

⚠ CAUTION

Indicates a potentially hazardous situation which, if not avoided, may result in minor or moderate injury to the user or patient, or cause damage to the equipment or other property.

- This device is intended for human use only.
- Provide close supervision when this device is used by, on, or near children or invalids.
- To avoid medication residue on your face, wipe your face after removing the mask.
- DO NOT get nebulized medication in your eyes.
- DO NOT insert any object into the main unit.
- Use ONLY Omron authorized parts and accessories (refer to section 6). Parts and accessories not approved for use with this device may damage the unit.
- DO NOT add more than 10ml of medication to the medication tank.
- DO NOT subject the device to any strong shocks such as dropping the device on the floor.
- DO NOT cover the main unit with items such as a blanket or towel during use.
- DO NOT disassemble or attempt to repair the main unit or AC adapter.
- While using this device, make sure that no mobile device or any other electrical devices that emit electromagnetic fields is within 12 inches (30 cm) of this device. This may result in incorrect operation of the device.
- Inspect the main unit and the parts before each use to ensure that parts are not damaged, the device is assembled properly and it is operating normally.
- DO NOT operate the device at temperatures greater than +104 °F (+40 °C).
- Operate the device only as intended. DO NOT use the device for any other purpose.
- Changes or modifications not approved by Omron Healthcare will void the user warranty.
- Dry the parts by air drying only. DO NOT use any equipment to dry the device parts.
- To prevent damage to the device, DO NOT clean the main unit using abrasive cleaners or any type of chemical.
- NEVER clean with benzene or thinner.
- Ensure that this device has acclimated to room temperature before nebulizing the medication. Nebulizing the medication after an extreme temperature change could lead to less nebulization. OMRON recommends waiting for approximately 2 hours for the device to warm up or cool down when the device is used at an environment within the temperature specified as operating conditions after it is stored either at the maximum or at the minimum storage temperature. For additional information of operating and storage/transport temperature, refer to section 7.
- DO NOT tilt the nebulizer kit greater than 45° from vertical direction. Medication may flow into the mouth.
- DO NOT shake the nebulizer kit when medication is in the medication tank. Medication may get in your eyes.
- DO NOT use the device while sleeping.
- To prevent damage to the device, DO NOT carry or leave the nebulizer kit with medication or distilled water in the medication tank.
- Make sure the air filter is clean. If the air filter has changed color or has been used on average for more than 60 days, replace it with a new one.

AC Adapter Handling and Usage

- Fully insert the AC adapter into the outlet. DO NOT use an extension cord.
- When unplugging the AC adapter from the outlet, be sure to safely pull from the AC adapter. DO NOT pull from the AC adapter cable.
- When handling the AC adapter cable:
 - DO NOT damage it.
 - DO NOT break it.
 - DO NOT tamper with it.
 - DO NOT forcibly bend or pull it.
 - DO NOT twist it.
 - DO NOT use it if it is gathered in a bundle.
 - DO NOT pinch it.
 - DO NOT place it under heavy objects.
- Wipe any dust off of the AC adapter.
- Unplug the AC adapter when not in use.
- Unplug the AC adapter before cleaning this device.
- Use ONLY the AC adapter designed by Omron for this device (refer to section 6 for optional accessories). Use of any other AC adapter may damage the device.

1. Know Your Device

1.1 Contents

Main Unit

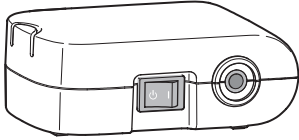

Nebulizer Kit



Mouthpiece



Air Tube

(PVC, 100 cm)

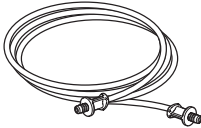

AC Adapter

(HEM-ADPTW5)

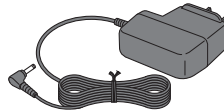

Child Mask

(PVC)



Air Filters

(Package of 5)

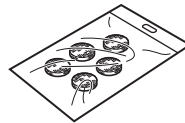

Child Accessory



Storage Case

Instruction Manual

1.2 Names of the Parts

Main Unit

Front

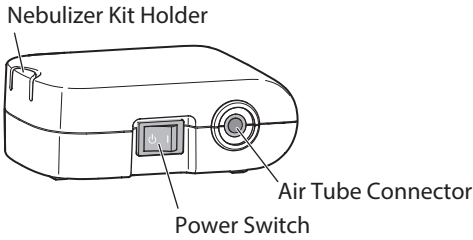

Bottom

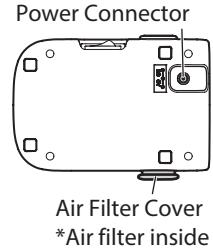

Nebulizer Kit

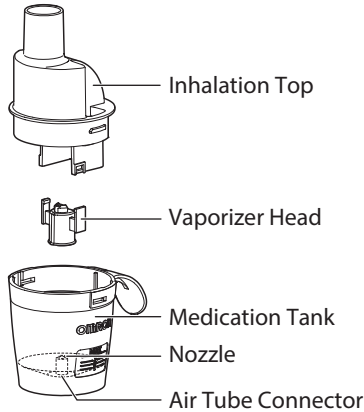

CAUTION

- Use ONLY Omron authorized parts and accessories (refer to section 6). Parts and accessories not approved for use with this device may damage the unit.

2. Preparation

2.1 Before Using the Device for the First Time

⚠ WARNING

- Failure to properly clean the COMP A-I-R components may cause bacterial growth, serious illness from contamination, compromised medication delivery.
- Clean the parts of this device before using this device for the first time, and also when the device has not been used for an extended period of time.

BEFORE FIRST USE:

- **Carefully read the instruction manual.**
- **Disassemble the parts and clean the nebulizer kit, mouthpiece, mask and child accessory.**
- **Dry all parts completely before using the device.**

2.2 Cleaning the Device Before First Use

1 Remove the inhalation top and vaporizer head from the medication tank.

Remove any accessories (mouthpiece, mask or child accessory) from the nebulizer kit if already attached.

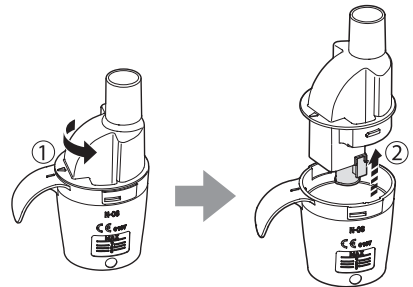

2 Remove the vaporizer head from the inhalation top.

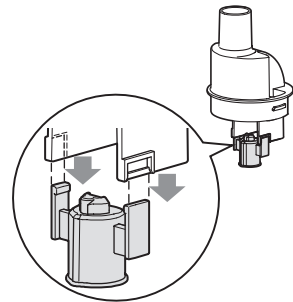

2.2 Cleaning the Device Before First Use

3 Wash the parts.

Wash the inhalation top, medication tank and accessories (mouthpiece, mask or child accessory) in warm water with mild (neutral) detergent and rinse all pieces thoroughly with clean hot tap water. Wash the vaporizer head with running tap water.

⚠ WARNING

- DO NOT leave the cleaning solution in the parts. Rinse the parts with clean tap water after cleaning.
- DO NOT immerse the main unit and the AC adapter in water or other liquid.

Wash in warm water with mild (neutral) detergent



Inhalation top



Medication tank



Mouthpiece



Mask



Child accessory

Wash with running tap water



Vaporizer head

DO NOT wash

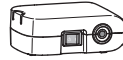

Main unit



Air tube

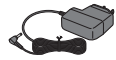

AC adapter

4 Dry the parts.

Allow to air dry in a clean environment.

⚠ WARNING

- After cleaning, allow the parts to dry before reassembling. To avoid contamination, store the device in a clean and safe location.

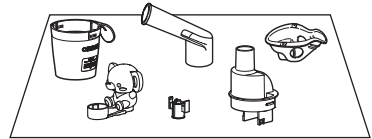

To assemble the nebulizer kit, refer to step 4 and 5 of sub-section 2.3.

2.3 Setting the Device

- 1 **Insert the power plug of the AC adapter into the power connector on the bottom of the main unit.**

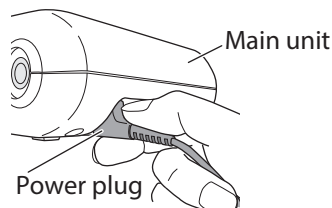

- 2 **Plug the AC adapter into the electric outlet.**

⚠ WARNING

- Plug the AC adapter into the appropriate voltage outlet. **DO NOT** use in a multi-outlet plug.
- **NEVER** plug in or unplug the AC adapter from the electric outlet with wet hands.

⚠ CAUTION

- Fully insert the AC adapter into the outlet. **DO NOT** use an extension cord.

- 3 **Add the correct amount of prescribed medication to the medication tank.**

Note

- If the inhalation top is assembled, remove it. Refer to step 1 of sub-section 2.2.
- If the vaporizer head came off the inhalation top and fell into the medication tank, remove it out of the tank.



⚠ WARNING

- **DO NOT** use Pentamidine with this device.
- For type, dose, and regimen of medication, follow the instructions of your physician and/or licensed healthcare practitioner.
- **DO NOT** spill water or other liquids, including medications, on the main unit and the AC adapter.
- **DO NOT** use only water in the nebulizer for inhalation purposes.

⚠ CAUTION

- **DO NOT** add more than 10 mL of medication to the medication tank.

2.3 Setting the Device

4 Attach the vaporizer head securely to the inhalation top.

Note

The sizes of the left- and right-hand attached parts of the vaporizer head are not the same. If the vaporizer head is not attached in the correct orientation, it will not nebulize correctly.

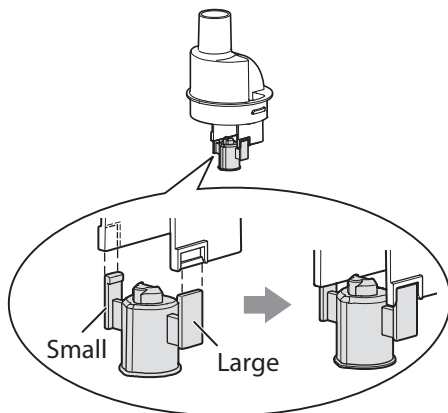

5 Put the inhalation top back inside the medication tank.

- 1 Align the protrusion on the inhalation top with the indentation on the medication tank as illustrated.
- 2 Rotate the inhalation top clockwise until the arrow mark on the inhalation top and the alignment mark on the medication tank are aligned and they click in place.

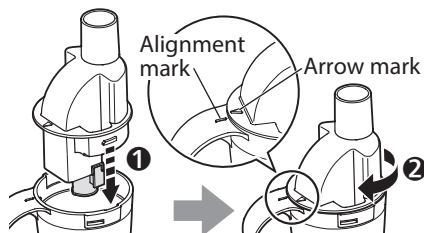

6 Attach the child accessory and mask or mouthpiece to the nebulizer kit tightly.

Note

Make sure an arrow mark on the nebulizer kit is facing toward the patient. Otherwise, medication may be sprayed on patient's skin or clothes.

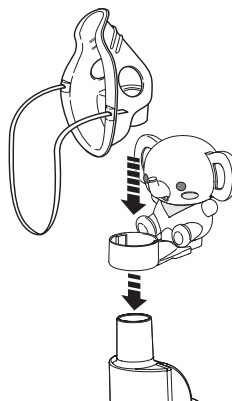

7 Connect the main unit and nebulizer kit.

Attach one end of the air tube to the main unit. Then attach the other end of the air tube to the nebulizer kit. Make sure the air tube plugs are firmly pushed into the air tube connectors.

Note

Keep the nebulizer kit upright when attaching the air tube. Otherwise, medication may spill out of the medication tank.

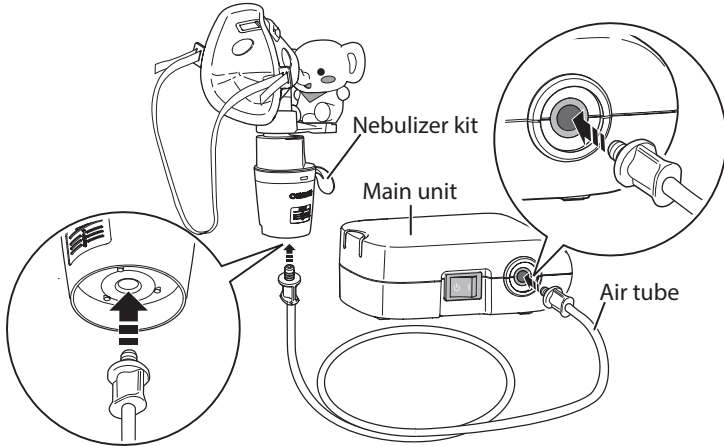

Use the nebulizer kit holder as a temporary holder for the nebulizer kit.

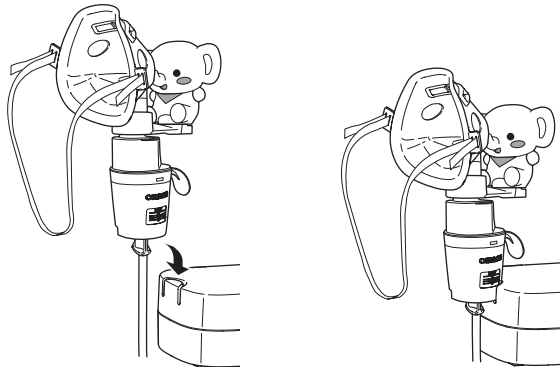

3. Using Your Device

3.1 Starting Inhalation

⚠ WARNING

- Keep this device out of the reach of unsupervised infants, toddlers and children. This device contains small parts that may cause a choking hazard if swallowed by infants, toddlers or children.
- DO NOT use this device where it may be exposed to flammable gas or vapors.
- DO NOT use or store this device in humid locations such as a bathroom.

⚠ CAUTION

- Inspect the main unit and the parts before each use to ensure that parts are not damaged, the device is assembled properly and it is operating normally.
- DO NOT operate the device at temperatures greater than +104°F (+40°C).
- While using this device, make sure that no mobile device or any other electrical devices that emit electromagnetic fields is within 12 inches (30 cm) of this device. This may result in incorrect operation of the device.

1 Hold the nebulizer kit as illustrated to the right.

⚠ CAUTION

- DO NOT tilt the nebulizer kit greater than 45° from vertical direction. Medication may flow into the mouth.

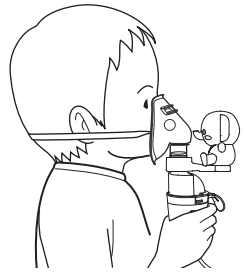
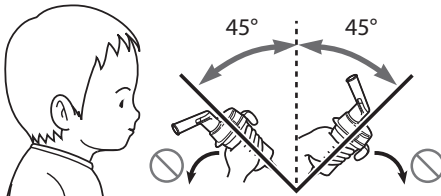

- DO NOT shake the nebulizer kit when medication is in the medication tank. Medication may get in your eyes.

2 Press the power switch to the on (I) position.

Nebulization begins and aerosol is generated.

⚠ CAUTION

- DO NOT cover the main unit with items such as a blanket or towel during use.

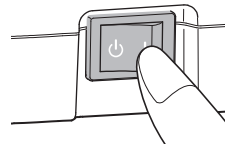

Note

- When using the device, the main unit may become hot. Do not touch the main unit except during necessary operation such as when turning the power off when nebulizing.
- To stop the nebulization, press the power switch to the off (⏻) position.

3 Inhale medication as instructed by your physician or licensed healthcare practitioner.

Using Child Mask

Place the mask over the nose and mouth. Pull the elastic strap over the head. Gently pull on the strap to secure the mask over the nose and mouth. Inhale the medication. Exhale normally through the mask.

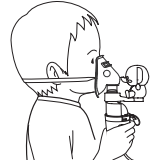

Using Mouthpiece

Insert the mouthpiece into your mouth. Inhale medication breathing normally. Exhale normally through the mouthpiece.



Using Nosepiece (optional)

Inhale the medication through the nosepiece as illustrated. Exhale through the mouth.



4 Complete the treatment.

Press the power switch to the off (⏻) position. The main unit turns off and nebulization stops.

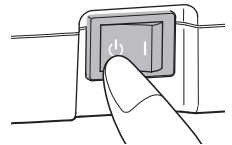

5 Disconnect the air tube from the nebulizer kit.

Hold the air tube plug and gently pull down to disconnect the air tube plug from the air tube connector on the bottom of the nebulizer kit.

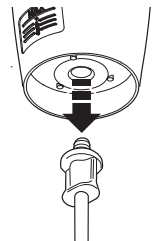

6 Check the air tube. No condensation or moisture should remain in the air tube.

⚠ WARNING

- After cleaning, allow the parts to dry before reassembling. To avoid contamination, store the device and parts in a clean and safe location.

If any condensation or moisture remains in the air tube, remove the moisture from the air tube. Follow the directions below:

1. Make sure the air tube is still connected to the air tube connector of the main unit.
2. Press the power switch on. The main unit pumps air through the air tube to expel the moisture.
3. Press the power switch off.

7 Disconnect the air tube from the main unit.

Hold the air tube plug and gently pull the air tube plug off the air tube connector.

8 Unplug the AC adapter from the electrical outlet.

⚠ CAUTION

- When unplugging the AC adapter from the outlet, be sure to safely pull from the AC adapter. DO NOT pull from the AC adapter cable.
- Unplug the AC adapter when not in use.

9 Disconnect the power plug from the main unit.

Securely hold and press the power plug down to disconnect the AC adapter.

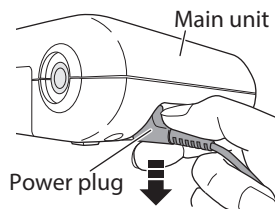

3.2 Cleaning the Device After Each Use

The following items should be disassembled and cleaned after each use in order to prevent any remaining medication in the tank from drying which will result in ineffective nebulization.

- Nebulizer kit (inhalation top, medication tank and vaporizer head)
- Mouthpiece
- Mask

Refer to "2.2 Cleaning the Device Before First Use" to clean each item.

Discard remaining medication in the medication tank if any.

⚠ WARNING

- ALWAYS dispose of any remaining medication after use. ALWAYS use fresh medication for each treatment.

Cleaning the Main Unit and Air Tube

Clean the casing of the main unit and the air tube by using a soft cloth moistened with water or a mild detergent. Do not use abrasive cleaners.

Dry the casing and air tube immediately using a soft clean cloth.

⚠ WARNING

- DO NOT immerse the main unit or the AC adapter in water or other liquid.

⚠ CAUTION

- Unplug the AC adapter before cleaning this device.
- DO NOT insert any object into the main unit.

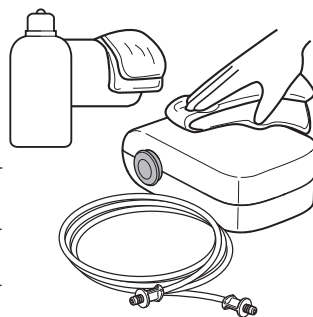

3.3 Cleaning the Device Weekly

The following items should be cleaned by boiling once a week. If the parts are heavily stained, replace them with new ones.

- Nebulizer kit (inhalation top, medication tank and vaporizer head)
- Mouthpiece

DO NOT boil the mask.

Parts may be boiled between 15 to 20 minutes.

After boiling, carefully remove the parts, shake off excess water and allow to air dry in a clean environment.

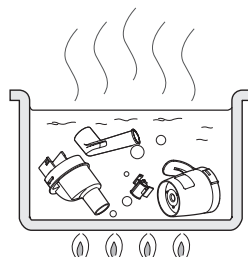

3.4 Changing the Air Filter

Change the air filter every 60 days even if it does not appear dirty. If it appears dirty, or water or medication has spilled on it, replace with a new one immediately.

1 Pull the air filter cover off the main unit.

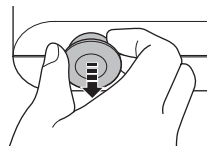

2 Remove the dirty air filter.

Note

Do not wash or clean the air filter. The dirty air filter should be disposed of.

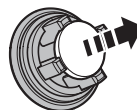

3 Insert a new air filter.

⚠ CAUTION

- Use ONLY Omron authorized parts and accessories (Refer to section 6). Parts and accessories not approved for use with this device may damage the unit.
- Make sure the air filter is clean. If the air filter has changed color or has been used on average for more than 60 days, replace it with a new one.

Note

- Do not substitute cotton or any other material for the filter.
- Before inserting the new air filter check to make sure it is clean and free of dust. Do not operate the device without the air filter.

4 Put the air filter cover back in place. Make sure it is attached properly.

3.5 Storing the Device

Store the main unit, air tube, nebulizer kit and accessories (mouthpiece, mask and child accessory) in a safe, clean location.

WARNING

- Keep this device out of the reach of unsupervised infants, toddlers and children. This device contains small parts that may cause a choking hazard if swallowed by infants, toddlers or children.
 - DO NOT leave this device or its parts in locations that are exposed to extreme temperature or humidity changes such as in a vehicle or in direct sunlight.
-

CAUTION

- DO NOT subject the device to any strong shocks such as dropping the device on the floor.
 - To prevent damage to the device, DO NOT carry or leave the nebulizer kit with medication or distilled water in the medication tank.
-

All of the nebulizer kit, mouthpiece, mask, air tube, child accessory and AC adapter can be placed in the storage case to carry with the main unit.

4. Troubleshooting

If any of the below problems occur, check to make sure that no other electrical device is within 12 inches (30 cm). If the problem persists, refer to the table below.

Problem	Possible cause	Solution
No power to the unit when the power switch is on.	The AC adapter is not plugged into an electrical outlet.	Press the power switch off. Plug the AC adapter into an electrical outlet. Turn the device on.
No nebulization or low nebulization rate when the power is on.	<ul style="list-style-type: none"> No medication in the medication tank. Too much or too little medication in the medication tank. 	Add the correct amount of prescribed medication to the medication tank.
	The vaporizer head is not attached to the inhalation top or incorrectly positioned.	Make sure the vaporizer head is correctly attached to the inhalation top.
	The nebulizer kit is not correctly assembled.	Make sure the nebulizer kit is correctly assembled and the inhalation accessory is correctly attached.
	The nozzle is blocked.	Clean the nebulizer kit to remove the blockage.
	The nebulizer kit is tilted at an incorrect angle.	Hold the nebulizer kit correctly. Do not tilt the nebulizer kit so the angle of the kit is greater than 45 degrees from vertical direction.
	The air tube is incorrectly attached.	Make sure the air tube is correctly attached to the main unit and nebulizer kit.
	<ul style="list-style-type: none"> The air tube is folded or damaged. The air tube is blocked. 	Make sure the air tube is not folded, kinked or bent. Inspect the air tube for any damage. Replace the air tube if damaged.
	The air filter is dirty.	Replace the air filter with a new one.
The main unit is abnormally loud.	The air filter cover is incorrectly attached.	Attach the air filter cover correctly. Make sure the air filter cover is not blocked.
The main unit is very hot.	The main unit is covered.	Do not cover the main unit with any type of cover during use.

If you are not able to solve your problem, contact 1-800-634-4350.

5. Disposal

Dispose of the device, components and optional accessories according to applicable local regulations.

6. Optional Medical Accessories

Product Description	Model
AC adapter	HEM-ADPTW5
Adult mask (PVC)	9920
Child mask (PVC)	9921
Air Filters (Package of 5)	C30FL
Nebulizer Kit Set (Includes Nebulizer Kit, Mouthpiece and Air Tube)	C803NEB
Mouthpiece	C910
Nosepiece	C911

7. Specifications

Product Category	Nebulizers
Product Description	Compressor nebulizer
Model	RE-C800KD ^[REF] NE-C803-KDZ
Rating	6 V = 0.7 A
Power source	100 - 240 V ~, 50 - 60 Hz, 0.12 - 0.065 A (AC adapter)
Operation Mode	Continuous operation
Nebulization Rate	Approx. 0.30 mL/min (by weight loss)*
Particle Size	MMAD** approx. 3 µm (based on EN13544-1:2007)
Medication Tank Capacity	10 mL (cc) max.
Appropriate Medication Quantities	2 - 10 mL (cc)
Sound	Less than 45 dB*
Operating conditions	+50 to +104 °F (+10 to +40 °C), 30 to 85 % RH (non-condensing), 700 to 1060 hPa
Transportation and storage conditions	-4 to +140 °F (-20 to +60 °C), 10 to 95 % RH (non-condensing), 700 to 1060 hPa
Weight	Approx. 6.4 oz. (180 g) (main unit only)
Dimensions	Approx. 3.3" (W) × 1.7" (H) × 4.5" (D) (85 × 43 × 115 mm) (main unit only)
Protection against electric shock	Class II ME equipment
IP classification	IP21
Applied Part	Type BF (mouthpiece, mask)

* Measured by OMRON HEALTHCARE Co., Ltd. Measured with saline at ambient temperature of +73 °F (+23 °C) and humidity of 40 %. It may vary with the type of medication.

**MMAD = Mass Median Aerodynamic Diameter

- These specifications are subject to change without notice.

7. Specifications

- IP classification is degrees of protection provided by enclosures in accordance with IEC 60529. This device is protected against solid foreign objects of 12.5 mm diameter and greater such as a finger, and against vertically falling water drops which may cause issues during a normal operation.
- Note that nebulization rate and particle size may vary with medication type used.
- Parts and accessories not approved for use do not meet these specifications.
- This unit conforms to EMC Standard IEC60601-1-2:2014. However, if it is used together with other medical devices or electrical equipment, they may influence the operations of one of devices. Follow any instructions in the manuals and use all devices correctly.
- Risk of electric shock and mechanical hazards have been mitigated in accordance with ANSI/AAMI ES 60601-1.
- Operation mode is classification in accordance with IEC 60601-1.

Durable Period

Durable periods are as follows, provided the product is used to nebulize approximately 2 mL of medication for 8 minutes each time at room temperature (23°C).

Durable period may vary depending on usage environment.
Frequent use of the product may shorten the durable period.

Main unit	5 years
Nebulizer Kit	1 year
Mouthpiece	1 year
Nosepiece	1 year
Air tube (PVC, 100 cm)	1 year
Air Filter	60 days
Child Mask (PVC)	1 year

Particle Specifications

A series of aerosol performance tests were performed using an 8-stage cascade impactor at sampling flow rates of 13 l/min and 30 l/min equipped with a USP <601> induction port throat. Aerosol was sampled directly from the outlet. Three (3) device samples were tested with 3 runs each, for a total of 9 sample points per each drug.

The specifications are listed below with intervals given for a 99 % confidence level.

The upper value is based on the sampling flow rate of 13 l/min, and the lower value (in parentheses) is based on the sampling flow rate of 30 l/min.

Mean / Std. Dev	Pulmicort® (250 µg/mL)	Intal® (10 mg/mL)	Salbutamol® (5 mg/mL)
Total Delivered Dose (µg)	321 (350)	13392 (12873)	6684 (6795)
Total Delivered Dose Fraction (%)	66 (70)	66 (64)	68 (68)
Particle size (MMAD) (µm)	5.56 (4.99)	3.22 (2.55)	2.93 (2.05)
Geometric Standard Deviation	2.2 (2.2)	2.8 (2.5)	3.2 (3.6)
Respirable Fraction (0.5-5 µm) (%)	45 (49)	61 (67)	56 (61)
Total Respirable Dose between 0.5-5 µm (µg)	1.5 (1.7)	81.6 (86.0)	37.5 (41.3)
Medication Captured on USP Throat (µg)	11.5 (12.3)	318.0 (252.1)	160.1 (141.7)
Medication Captured on USP Throat Fraction (%)	4 (4)	2 (2)	2 (2)
Medication Retained in Device (µg)	165 (150)	6777 (7127)	3135 (3135)
Medication Retained in Device Fraction (%)	34 (30)	34 (36)	32 (32)
Coarse Particle Fraction (%) (>4.7 µm)	55 (51)	37 (29)	36 (28)
Fine Particle Fraction (%) (<4.7 µm)	44 (49)	63 (69)	63 (73)
Ultra-Fine Particle Fraction (%) (<1.0 µm)	1 (2)	11 (16)	20 (32)

Note

Coarse particles (oro-pharyngeal deposition) and ultra-fine particles (exhaled) are not likely to deposit in the patient's airway and thus provide limited clinical benefit.

8. FCC Statement

FCC CAUTION

Changes or modifications not expressly approved by the party responsible for compliance could void the user's authority to operate the equipment.

This device complies with Part 15 of FCC Rules. Operation is subject to the following two conditions: (1) this device may not cause harmful interference, and (2) this device must accept any interference received, including interference that may cause undesired operation.

Note:

This equipment has been tested and found to comply with the limits for a Class B digital device, pursuant to part 15 of the FCC Rules. These limits are designed to provide reasonable protection against harmful interference in a residential installation. This equipment generates, uses and can radiate radio frequency energy and, if not installed and used in accordance with the instructions, may cause harmful interference to radio communications. However, there is no guarantee that interference will not occur in a particular installation. If this equipment does cause harmful interference to radio or television reception, which can be determined by turning the equipment off and on, the user is encouraged to try to correct the interference by one or more of the following measures:

- Reorient or relocate the receiving antenna.
- Increase the separation between the equipment and receiver.
- Connect the equipment into an outlet on a circuit different from that to which the receiver is connected.
- Consult the dealer or an experienced radio/TV technician for help.

9. Limited Warranty

Your RE-C800KD main unit, excluding the nebulizer kit, inhalation accessories, air tube, air filters, AC adapter and storage case is warranted to be free from defects in materials and workmanship appearing within 3 years from the date of purchase, when used in accordance with the instructions provided with the RE-C800KD.

The above warranty extends only to the original retail purchaser. We will inspect and replace your unit without charge as deemed necessary by the above warranty. This is our only responsibility and your only remedy under the above warranty.

To obtain warranty service contact Customer Service by calling **1-800-634-4350** for the address of the inspection center and the return shipping and handling fee.

Enclose the original printed receipt. Include a letter, with your name, address, phone number, and description of the specific problem. Pack the product carefully to prevent damage in transit. Because of possible loss in transit, we recommend insuring the product with return receipt requested.

THE FOREGOING IS THE SOLE WARRANTY PROVIDED BY OMRON IN CONNECTION WITH THIS PRODUCT, AND OMRON HEREBY DISCLAIMS ANY OTHER WARRANTIES, EXPRESS OR IMPLIED, INCLUDING IMPLIED WARRANTIES OF MERCHANTABILITY AND FITNESS FOR A PARTICULAR PURPOSE. IMPLIED WARRANTIES AND OTHER TERMS THAT MAY BE IMPOSED BY LAW, IF ANY, ARE LIMITED IN DURATION TO THE PERIOD OF THE ABOVE EXPRESS WARRANTY.

OMRON SHALL NOT BE LIABLE FOR LOSS OF USE OR ANY OTHER SPECIAL, INCIDENTAL, CONSEQUENTIAL OR INDIRECT COSTS, EXPENSES OR DAMAGES.

This warranty provides you with specific legal rights, and you may have other rights that vary by jurisdiction. Because of special local requirements, some of the above limitations and exclusions may not apply to you.

FOR CUSTOMER SERVICE

Visit our website at:

OmronHealthcare.com

Call toll free:

1-800-634-4350

10. Guidance and Manufacturer's Declaration

OMRON RE-C800KD

Information for Accompanying Documents in the Scope of IEC60601-1-2:2014

Important information regarding Electromagnetic Compatibility (EMC)

RE-C800KD conforms to IEC60601-1-2:2014 Electromagnetic Compatibility (EMC) standard. Further documentation in accordance with this EMC standard is available at OmronHealthcare.com/emc. Refer to the EMC information for RE-C800KD on the website.



OMRON HEALTHCARE Co., Ltd.

53, Kunotsubo, Terado-cho, Muko,
Kyoto, 617-0002 JAPAN

Distributed by:

OMRON HEALTHCARE, INC.

1925 West Field Court
Lake Forest, IL 60045 USA
OmronHealthcare.com

© 2020 OMRON HEALTHCARE, INC.
Made in Vietnam

For questions, call: 1-800-634-4350