

OPERATION MANUAL

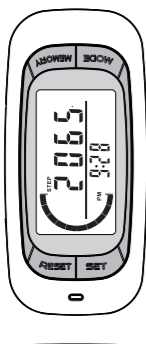

3D SENSOR
PEDOMETER

GETTING STARTED/ FIRST TIME USE

- Pull battery insulator to activate the pedometer.
- If LCD display is not functioning normal and showing abnormal characters, please perform a 'SYSTEM RESET'. SEE SECTION (8): PERFORMING A SYSTEM RESET
- The LCD may show some faint background digits. This is normal because of fresh battery. This will disappear when the battery drop to normal operating voltage.

Viewing "Total distance walked"
- Press "SET" under total step mode display

Viewing "Total calories burnt"
- Press "SET" twice under total step mode display

Viewing "Total time walked"
- Press "SET" as many times as necessary under the total step mode display
- To reset the counter, press and hold the RESET button until the digits revert back to zero.

WARNING:
All pedometer data including memory will also be reset to '0'.

B. 'STEP' FUNCTION
- Press MODE button until the top of the display shows the word "STEP". This shows the number of steps walked during the day.



- To reset the step counter, press and hold the RESET button until the digits revert back to zero.

NOTE:
The pedometer data for the day will also be reset to '0'.

C. 10 STEPS ERROR CORRECTION
To avoid counting accidental movements as steps, the counter will start counting once 10 or more consecutive steps are detected.

D. DISTANCE TRAVELED
- Press MODE button until the display shows the word "KM/MILE".
- The distance counter will start counting once motion is detected (must be 10 consecutive steps or more).
- To reset the distance counter, press and hold the RESET button until the digits revert back to zero

NOTE:
The pedometer data for the day will also be reset to '0'.

E. CALORIES
- Press MODE button until the display shows "KCAL".
- It will start counting once motion is detected.
- To reset the calorie counter, press and hold the RESET button until the digits revert to zero.

F. ACTIVITY TIME
Record the total time walked during the day
- Press MODE until the display shows "ACTIVITY".
- The timer will start counting once motion is detected.
- To reset the activity timer, press and hold the RESET button until the digits revert to zero.
NOTE: All pedometer data for the day will also be reset to '0'.

4. USING THE MEMORY FUNCTION
This unit can store up to 7 days data for the total steps walked per day.
The data for the day is automatically stored in memory when the clock time reaches 12:00am midnight. The display will reset to '0' for the new day.

WARNING: Changing current clock time may affect the data stored in the pedometer memory.

- To view the data stored in Memory, press MEMORY button to display the data stored the previous day

- Press SET repeatedly to display each category: Steps, Distance, Calories or Activity Time)

- Press MEMORY repeatedly to display each previous day's stored data, up to seven days; with [-7 DAYS BEFORE / AGO] being the last set of stored data.

CLEARING THE MEMORY DATA TO '0'
- Go to "TOTAL STEP" mode, press and hold "RESET" button until the digits on the display reset to '0'

Note: ALL PEDOMETER DATA INCLUDING DAILY AND MEMORY WILL BE CLEARED !!!

PLEASE READ MANUAL CAREFULLY BEFORE OPERATING

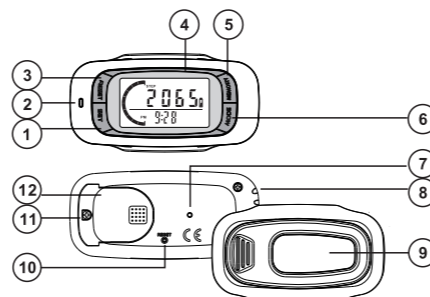

- FUNCTION:**
- | | |
|-------------------------|--------------------------------|
| 1. SET Button | 7. Buzzer hole |
| 2. TARGET LED indicator | 8. Lanyard hole |
| 3. RESET Button | 9. Detachable holder with clip |
| 4. LCD display | 10. SYSTEM RESET Hole |
| 5. MEMORY Button | 11. Screw |
| 6. MODE Button | 12. Battery Cover |

- FEATURES:**
- PEDOMETER**
- 3D Silent Pedometer Sensor
 - Step count up to 99999 steps
 - Distance walked record up to 999.99 KM/ 999.99 Miles
 - Calories burnt indication up to 9999.9 Kcal
 - Metric and Imperial unit system selection
 - 10 Steps False Start Error Correction
- TARGET**
- Set your daily walking steps target
- CLOCK**
- 12/24 Hours Format
- ACTIVITY TIME**
- Record your daily activity time during walking
- 7 DAY MEMORY**
- Record your pedometer activities up to 7 days
- LOW BATTERY INDICATOR**
- When battery is low, this icon (🔋) will show up on the display

Example: To view the data stored in memory

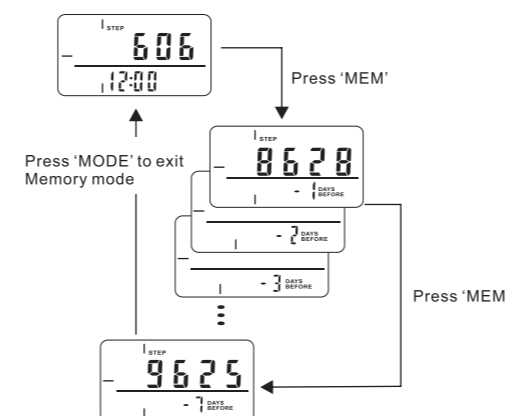

Note:
The clock time is not displayed under the Memory mode.
- Press 'MODE' to exit Memory mode.

1. SETTING YOUR PERSONAL DATA AND CLOCK TIME

- In 'STEP' mode, Press and hold "SET" until the display shows the icon "SETUP" and the digits start to blink.

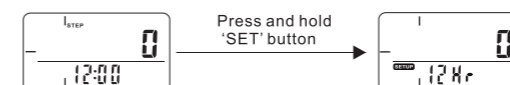

Fig. 1: Setup screen

- Press RESET button to toggle select "12Hr" or "24Hr" for 12 or 24 hours clock display format.
- Press SET / enter clock setting mode.
- Press MODE / RESET to set desired Hour.
- Press SET to enter Minutes setting
- Press MODE / RESET to set the desired Minutes.
- Press SET to enter unit system selection setting
- Press RESET to toggle select IN (Imperial) or KG (Metric) units [see fig. 2a].

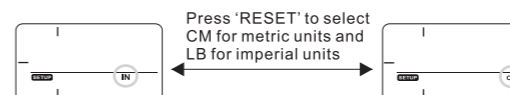

Fig. 2a: Under Setup mode: selecting metric or imperial units

- Press SET to confirm and enter Stride Setting mode
- Press MODE / RESET to set the desired stride value.

Note: To set the stride, see section 'SETTING THE STRIDE LENGTH'

- Press SET to enter Weight setting mode.
- Press MODE / RESET to set your body weight.
- Press SET to enter STEPS TARGET setting mode.
- Press MODE / RESET to set your walking steps TARGET in intervals of 1000 steps. Steps less than 1000 steps will be in intervals of 100s.



Fig. 2b: Under Setup mode: setting daily target steps

- Press "SET" or leave it idle for approx. 10 seconds to confirm setting.

5. TARGET STEP

TARGET STEPS is the goal you want to walk and achieved each day.
The target step setting is done under the SETTING mode in section 1.

Understanding the "TARGET" progress bar:

For example 5000 steps

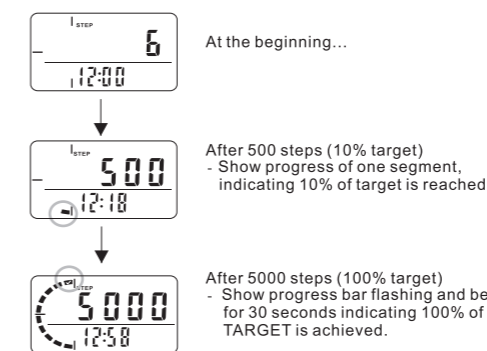

When the "TARGET STEP" is achieved, the progress bar on the LCD display flashes and beep for 30 seconds.

6. LOW BATTERY INDICATOR

When the battery power is dropped to certain level, the low battery indicator icon (🔋) will show up on the display. It is time to replace with fresh battery.

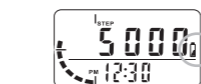

SETTING YOUR STRIDE LENGTH:

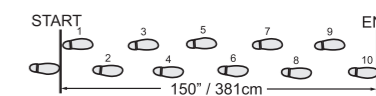

- As above illustration, walk 10 steps with your normal stride
- Measure the distance from start to end
- Calculate your stride by dividing the total distance by 10

Example:
Total Distance is 150". Therefore, stride = 150" / 10 paces = 15"
Total Distance = 381cm. Therefore, stride = 381cm / 10 paces = 38cm**
**(rounded off to the nearest unit)

Note:
Stride Setting range
- Metric: Range from 30cm ~ 213 cm; with setting at 1cm interval
- Imperial: Range from 12inch ~ 84inch; with setting at 1 inch interval
- Default Stride: 30 inch / 80cm

2. CLOCK FUNCTION - 12H/24H format

The clock can display the time in 12H or 24H format. This can only be selected under the setting mode and no other mode.

For 12H format, only the PM icon show for noon time.

3. PEDOMETER FUNCTION

The paces are detected via the walking movement. You can place the unit inside your pocket or inside your handbag/back pack.

A. 'TOTAL STEP' FUNCTION



- Press MODE button until the top of the display shows the word "TOTAL STEP". This shows the record of total number of steps accumulated since the last reset of the pedometer step counter. This is the total number of steps walked over a period of time.

7. SLEEP MODE

If the pedometer is left idle for 30 seconds, the LCD display will shut off automatically. If movements are detected, the pedometer will wake up from sleep mode.

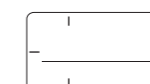

Fig. 3: Under sleep mode: LCD display automatically shut off.

8. PERFORMING A SYSTEM RESET

Perform a SYSTEM RESET action in the following situations:
- When old batteries are being replaced
- When the digits on the display becomes unrecognizable
- When pressing any keys has no action

Press the SYSTEM RESET button on the back of the unit using a pin or paper clip. The display will revert to default setting.

WARNING: all data stored in MEMORY, clock time and personal data (weight and stride length) will also be erased.

You will need to set the clock time and personal data again.

9. REPLACING THE BATTERY

The pedometer uses 1 piece of CR-2032 button cell battery.
- Remove the screw and the battery cover
- Take out the old button cell battery.
- Put fresh battery into the compartment. Make sure it is inserted in its correct polarity position.
- Place and screw the battery cover back onto the compartment.

10. SPECIFICATIONS

BATTERY : Use CR-2032 x 1pc [Included]
TIME DISPLAY: 12/24 Hour System

Patent pending

