

Turbo air
AIR CONDITIONER MANUFACTURER

4184 E. Conant St.
Long Beach, CA 90808
Tel. 888-900-1002
Fax. 310-900-1088
www.turboairinc.net

Project :

Model # :

Item # :

Qty :

Approval :

Center Mount Cooler

Model : TCA140A



≡ FEATURES / BENEFITS ≡



Blue Anti-Corrosion
Hydrophobic Coated Fin.
Air Pass Guard for Better
Efficiency.



Inner Groove Copper Tube
for Maximum Coil Efficiency.
Mounted TXV, Solenoid,
Thermostat(Optional).



Stainless Steel Mount-
ing, Bolt and Drain.
Double Drain Pan for
Easier Cleaning.

MODEL CAPACITY

- Air Defrost Coil : 5800(1 Fan) ~ 35600BTU(5 Fan)
- Electric Defrost Coil : 5800(1 Fan) ~ 35600BTU(5 Fan)
- Optional EC Motor Available

Center Mount Cooler

Model : TCA140A

TCA Air Defrost Models 60Hz. With PSC Motors.

Capacity BTUH/Watts 10°F /6°C TD 25°F / -4°C SST	Capacity BTUH/Watts 15°F /8°C TD 25°F / -4°C SST	Fan Data	
		CFM / m ³ H	No.
14031 / 4109	19721 / 5776	2218 / 3768	2

PSC Motor Data		
115V 1Ph 60Hz		
HP	Total Amps	Watts
1/15	1.50	160

Connections (Inches)				Approx. Net Wt. Lbs
Coil Inlet	Suction	External Equalizer	Drain	
1/2 OD	1-1/8 ID	1/4 OD	3/4 MPT	137

Design and specifications subject to change without notice

■ **WARRANTY : 1 Year Fan Motor and Parts Warranty**

PLAN VIEW

(unit : inch)

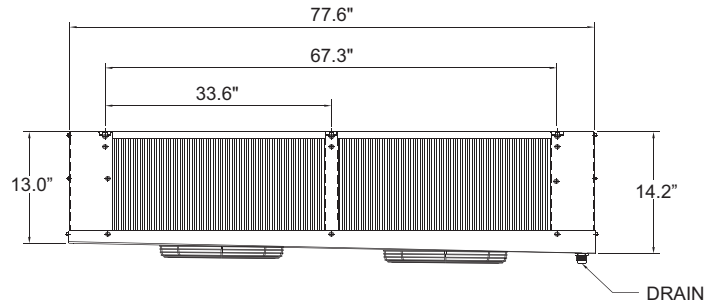

FRONT VIEW

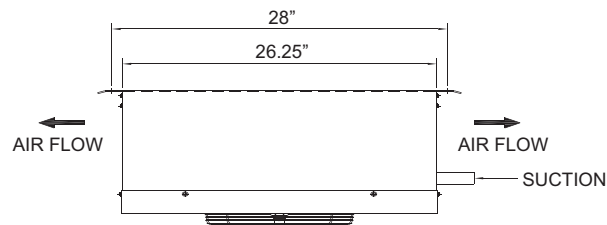

RIGHT SIDE VIEW



■ Toll Free : 888-900-1002