

Service Manual

Multi-Split Type Air Conditioners 2/3/4MXS-N Series

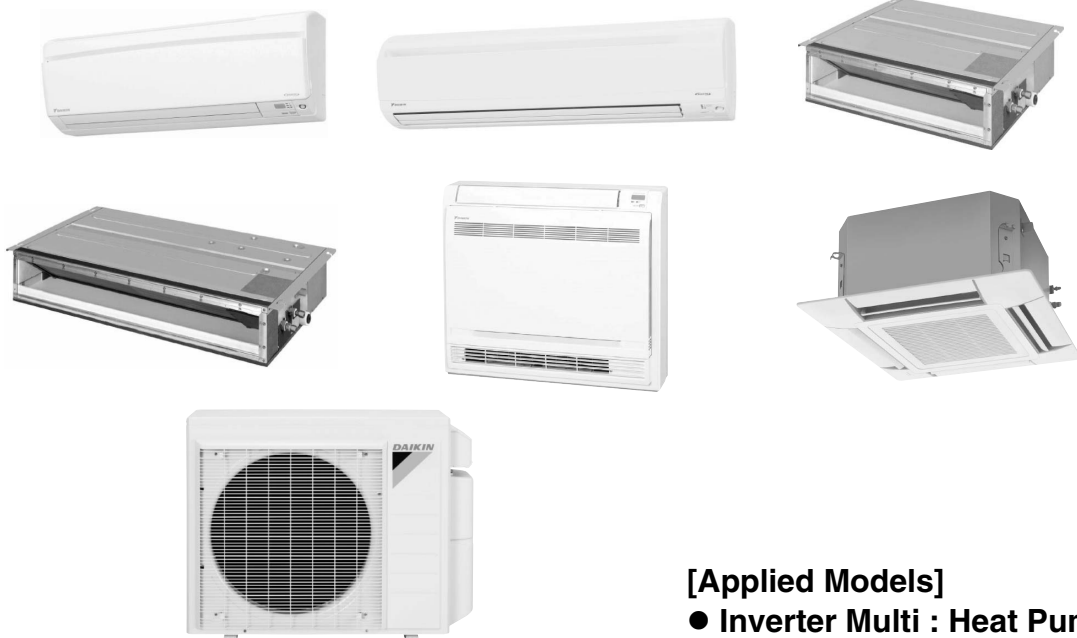

[Applied Models]

- Inverter Multi : Heat Pump

Multi-Split Type Air Conditioners 2/3/4MXS-N Series

●Heat Pump Indoor Unit

CTXS07LVJU
FTXS09LVJU
FTXS12LVJU
FTXS15LVJU
FTXS18LVJU
FTXS24LVJU

FDXS09LVJU
FDXS12LVJU
CDXS15LVJU
CDXS18LVJU
CDXS24LVJU

FVXS09NVJU
FVXS12NVJU
FVXS18NVJU

FFQ09LVJU
FFQ12LVJU
FFQ15LVJU
FFQ18LVJU

Outdoor Unit

2MXS18NMVJU
3MXS24NMVJU
4MXS36NMVJU

1. Safety Cautions.....	vi
1.1 Warnings and Cautions Regarding Safety of Workers.....	vi
1.2 Warnings and Cautions Regarding Safety of Users.....	viii
2. Used Icons	xi
Part 1 List of Functions	1
1. Functions.....	2
Part 2 Specifications	7
1. Indoor Unit.....	8
2. Outdoor Unit.....	14
Part 3 Printed Circuit Board Connector Wiring Diagram	17
1. Indoor Unit.....	18
1.1 CTXS07LVJU, FTXS09/12LVJU	18
1.2 FTXS15/18/24LVJU	20
1.3 FDXS09/12LVJU, CDXS15/18/24LVJU	22
1.4 FVXS09/12/18NVJU.....	24
1.5 FFQ09/12/15/18LVJU	26
2. Wired Remote Controller.....	27
2.1 BRC1E71	27
2.2 BRC1E72/73	28
3. Wireless Remote Controller	29
3.1 BRC7E830	29
4. Outdoor Unit.....	30
Part 4 Function and Control.....	33
1. Function of CTXS, FTXS, CDXS, FDXS, FVXS Series	34
1.1 Temperature Control	34
1.2 Frequency Principle.....	34
1.3 Airflow Direction Control (CTXS, FTXS, FVXS Series)	36
1.4 Fan Speed Control for Indoor Unit	39
1.5 Program Dry Operation	40
1.6 Automatic Operation.....	41
1.7 Thermostat Control.....	42
1.8 NIGHT SET Mode	43
1.9 ECONO Operation	43
1.10 INTELLIGENT EYE Operation (CTXS, FTXS Series).....	44
1.11 Inverter POWERFUL Operation	45
1.12 Clock Setting	46
1.13 WEEKLY TIMER Operation (CTXS, FTXS, FVXS series)	47
1.14 Other Functions.....	53
2. Function of FFQ Series	54
2.1 Drain Pump Control.....	54
2.2 Thermostat Sensor in Remote Controller	56

2.3	Freeze Prevention Control	58
2.4	Hot Start Control (In Heating Operation Only).....	59
3.	Control Specification	60
3.1	Function of Thermistor	60
3.2	Mode Hierarchy	62
3.3	Frequency Control.....	63
3.4	Controls at Mode Changing / Start-up.....	65
3.5	Discharge Pipe Temperature Control.....	66
3.6	Input Current Control.....	67
3.7	Freeze-up Protection Control	68
3.8	Heating Peak-cut Control	68
3.9	Outdoor Fan Control.....	69
3.10	Liquid Compression Protection Function.....	69
3.11	Defrost Control	70
3.12	Low Hz High Pressure Limit	71
3.13	Electronic Expansion Valve Control	72
3.14	Malfunctions	77

Part 5 Remote Controller 78

1.	CTXS, FTXS Series	79
2.	CDXS, FDXS Series	81
3.	FVXS Series.....	83
4.	FFQ Series.....	85
4.1	<BRC1E71> Wired Remote Controller.....	85
4.2	<BRC1E72/73> Wired Remote Controller.....	90
4.3	<BRC7E830> Wireless Remote Controller	96

Part 6 Service Diagnosis..... 97

1.	General Problem Symptoms and Check Items	99
2.	Troubleshooting with LED	100
2.1	Indoor Unit.....	100
2.2	Outdoor Unit.....	101
3.	Service Diagnosis	102
3.1	CTXS, FTXS, CDXS, FDXS, FVXS Series	102
3.2	FFQ Series	108
4.	Code Indication on Remote Controller	114
4.1	CTXS, FTXS, CDXS, FDXS, FVXS Series	114
4.2	FFQ Series	114
4.3	Outdoor Unit.....	115
5.	Troubleshooting for CTXS, FTXS, CDXS, FDXS, FVXS Series	116
5.1	Indoor Unit PCB Abnormality	116
5.2	Freeze-up Protection Control / Heating Peak-cut Control	118
5.3	Fan Motor or Related Abnormality	119
5.4	Thermistor or Related Abnormality.....	123
5.5	Signal Transmission Error (Between Indoor Unit and Outdoor Unit).....	124
5.6	Unspecified Voltage (Between Indoor Unit and Outdoor Unit)	126

6.	Troubleshooting for FFQ Series	127
6.1	Indoor Unit PCB Abnormality	127
6.2	Drain Level Control System Abnormality	128
6.3	Fan Motor (AC Motor) or Related Abnormality	129
6.4	Drain System Abnormality	130
6.5	Thermistor or Related Abnormality	131
6.6	Remote Controller Thermistor Abnormality	132
6.7	Signal Transmission Error (Between Indoor Unit and Remote Controller)	133
6.8	Signal Transmission Error (Between MAIN Remote Controller and SUB Remote Controller)	134
6.9	Field Setting Abnormality	135
7.	Troubleshooting for Outdoor Unit	136
7.1	Refrigerant Shortage	136
7.2	Low-voltage Detection or Over-voltage Detection	138
7.3	Wiring Error Check Unexecuted	140
7.4	Unspecified Voltage (Between Indoor Unit and Outdoor Unit) / Anti-icing Control in Other Rooms	141
7.5	Anti-icing Control for Indoor Unit	142
7.6	Outdoor Unit PCB Abnormality	144
7.7	OL Activation (Compressor Overload)	145
7.8	Compressor Lock	147
7.9	DC Fan Lock	148
7.10	Input Overcurrent Detection	149
7.11	Four Way Valve Abnormality	150
7.12	Discharge Pipe Temperature Control	152
7.13	High Pressure Control in Cooling	153
7.14	Compressor Sensor System Abnormality	154
7.15	Position Sensor Abnormality	156
7.16	CT or Related Abnormality	158
7.17	Thermistor or Related Abnormality (Outdoor Unit)	160
7.18	Electrical Box Temperature Rise	162
7.19	Radiation Fin Temperature Rise	163
7.20	Output Overcurrent Detection	164
8.	Check	166
8.1	Thermistor Resistance Check	166
8.2	Indoor Fan Motor Connector Check	167
8.3	Hall IC Check	167
8.4	Power Supply Waveform Check	168
8.5	Electronic Expansion Valve Check	169
8.6	Four Way Valve Performance Check	170
8.7	Inverter Unit Refrigerant System Check	170
8.8	Inverter Analyzer Check	171
8.9	Rotation Pulse Check on the Outdoor Unit PCB	172
8.10	Installation Condition Check	173
8.11	Discharge Pressure Check	173
8.12	Outdoor Fan System Check	174
8.13	Main Circuit Short Check	174
8.14	Capacitor Voltage Check	175

8.15 Power Module Check	176
-------------------------------	-----

Part 7 Trial Operation and Field Settings..... 177

1. Pump Down Operation	178
2. Wiring Error Check Function	179
3. Trial Operation	181
3.1 CTXS, FTXS, CDXS, FDXS, FVXS Series	181
3.2 FFQ Series	183
4. Field Settings	185
4.1 Outdoor Unit	185
4.2 CTXS, FTXS, CDXS, FDXS, FVXS Series	187
4.3 FFQ Series	192
5. Silicon Grease on Power Transistor / Diode Bridge	199





Part 8 Appendix..... 200

1. Piping Diagrams	201
1.1 Indoor Unit	201
1.2 Outdoor Unit	204
2. Wiring Diagrams	206
2.1 Indoor Unit	206
2.2 Outdoor Unit	211



1. Safety Cautions

Be sure to read the following safety cautions before conducting repair work. After the repair work is complete, be sure to conduct a test operation to ensure that the equipment operates normally, and explain the cautions for operating the product to the customer.







Caution Items





The caution items are classified into  **Warning** and  **Caution**. The  **Warning** items are especially important since they can lead to death or serious injury if they are not followed closely. The  **Caution** items can also lead to serious accidents under some conditions if they are not followed. Therefore, be sure to observe all the safety caution items described below.







Pictograms



-  This symbol indicates the item for which caution must be exercised.
The pictogram shows the item to which attention must be paid.
-  This symbol indicates the prohibited action.
The prohibited item or action is shown in the illustration or near the symbol.
-  This symbol indicates the action that must be taken, or the instruction.
The instruction is shown in the illustration or near the symbol.

1.1 Warnings and Cautions Regarding Safety of Workers







 Warning	
Do not store the equipment in a room with successive fire sources (e.g., naked flame, gas appliance, electric heater).	
Be sure to disconnect the power cable plug from the plug socket before disassembling the equipment for repair. Working on the equipment that is connected to the power supply may cause an electrical shock. If it is necessary to supply power to the equipment to conduct the repair or inspecting the circuits, do not touch any electrically charged sections of the equipment.	
If the refrigerant gas is discharged during the repair work, do not touch the discharged refrigerant gas. The refrigerant gas may cause frostbite.	
When disconnecting the suction or discharge pipe of the compressor at the welded section, evacuate the refrigerant gas completely at a well-ventilated place first. If there is gas remaining inside the compressor, the refrigerant gas or refrigerating machine oil discharges when the pipe is disconnected, and it may cause injury.	
If the refrigerant gas leaks during the repair work, ventilate the area. The refrigerant gas may generate toxic gases when it contacts flames.	
Be sure to discharge the capacitor completely before conducting repair work. The step-up capacitor supplies high-voltage electricity to the electrical components of the outdoor unit. A charged capacitor may cause an electrical shock.	











 Warning	
Do not start or stop the air conditioner operation by plugging or unplugging the power cable plug. Plugging or unplugging the power cable plug to operate the equipment may cause an electrical shock or fire.	
Be sure to wear a safety helmet, gloves, and a safety belt when working at a high place (more than 2 m (6.5 ft)). Insufficient safety measures may cause a fall accident.	
In case of R-32 / R-410A refrigerant models, be sure to use pipes, flare nuts and tools for the exclusive use of the R-32 / R-410A refrigerant. The use of materials for R-22 refrigerant models may cause a serious accident such as a damage of refrigerant cycle as well as an equipment failure.	
Do not mix air or gas other than the specified refrigerant (R-32 / R-410A / R-22) in the refrigerant system. If air enters the refrigerating system, an excessively high pressure results, causing equipment damage and injury.	











 Caution	
Do not repair the electrical components with wet hands. Working on the equipment with wet hands may cause an electrical shock.	
Do not clean the air conditioner by splashing water. Washing the unit with water may cause an electrical shock.	
Be sure to provide the earth / grounding when repairing the equipment in a humid or wet place, to avoid electrical shocks.	
Be sure to turn off the power switch and unplug the power cable when cleaning the equipment. The internal fan rotates at a high speed, and may cause injury.	
Be sure to conduct repair work with appropriate tools. The use of inappropriate tools may cause injury.	

 Caution	
<p>Be sure to check that the refrigerating cycle section has cooled down enough before conducting repair work. Working on the unit when the refrigerating cycle section is hot may cause burns.</p>	
<p>Use the welder in a well-ventilated place. Using the welder in an enclosed room may cause oxygen deficiency.</p>	

1.2 Warnings and Cautions Regarding Safety of Users





 Warning	
<p>Do not store the equipment in a room with successive fire sources (e.g., naked flame, gas appliance, electric heater).</p>	
<p>Be sure to use parts listed in the service parts list of the applicable model and appropriate tools to conduct repair work. Never attempt to modify the equipment. The use of inappropriate parts or tools may cause an electrical shock, excessive heat generation or fire.</p>	
<p>If the power cable and lead wires have scratches or deteriorated, be sure to replace them. Damaged cable and wires may cause an electrical shock, excessive heat generation or fire.</p>	
<p>Do not use a joined power cable or extension cable, or share the same power outlet with other electrical appliances, since it may cause an electrical shock, excessive heat generation or fire.</p>	
<p>Be sure to use an exclusive power circuit for the equipment, and follow the local technical standards related to the electrical equipment, the internal wiring regulations, and the instruction manual for installation when conducting electrical work. Insufficient power circuit capacity and improper electrical work may cause an electrical shock or fire.</p>	
<p>Be sure to use the specified cable for wiring between the indoor and outdoor units. Make the connections securely and route the cable properly so that there is no force pulling the cable at the connection terminals. Improper connections may cause excessive heat generation or fire.</p>	

 Warning	
<p>When wiring between the indoor and outdoor units, make sure that the terminal cover does not lift off or dismount because of the cable. If the cover is not mounted properly, the terminal connection section may cause an electrical shock, excessive heat generation or fire.</p>	
<p>Do not damage or modify the power cable. Damaged or modified power cable may cause an electrical shock or fire. Placing heavy items on the power cable, and heating or pulling the power cable may damage the cable.</p>	
<p>Do not mix air or gas other than the specified refrigerant (R-32 / R-410A / R-22) in the refrigerant system. If air enters the refrigerating system, an excessively high pressure results, causing equipment damage and injury.</p>	
<p>If the refrigerant gas leaks, be sure to locate the leaking point and repair it before charging the refrigerant. After charging refrigerant, make sure that there is no refrigerant leak. If the leaking point cannot be located and the repair work must be stopped, be sure to perform pump-down and close the service valve, to prevent the refrigerant gas from leaking into the room. The refrigerant gas itself is harmless, but it may generate toxic gases when it contacts flames, such as fan and other heaters, stoves and ranges.</p>	
<p>When relocating the equipment, make sure that the new installation site has sufficient strength to withstand the weight of the equipment. If the installation site does not have sufficient strength and if the installation work is not conducted securely, the equipment may fall and cause injury.</p>	
<p>Check to make sure that the power cable plug is not dirty or loose, then insert the plug into a power outlet securely. If the plug has dust or loose connection, it may cause an electrical shock or fire.</p>	
<p>Be sure to install the product correctly by using the provided standard installation frame. Incorrect use of the installation frame and improper installation may cause the equipment to fall, resulting in injury.</p>	<p>For unitary type only</p> <div style="text-align: center;">  </div>
<p>Be sure to install the product securely in the installation frame mounted on the window frame. If the unit is not securely mounted, it may fall and cause injury.</p>	<p>For unitary type only</p> <div style="text-align: center;">  </div>
<p>When replacing the coin battery in the remote controller, be sure to dispose of the old battery to prevent children from swallowing it. If a child swallows the coin battery, see a doctor immediately.</p>	

 Caution	
Installation of a leakage breaker is necessary in some cases depending on the conditions of the installation site, to prevent electrical shocks.	
Do not install the equipment in a place where there is a possibility of combustible gas leaks. If the combustible gas leaks and remains around the unit, it may cause a fire.	
Check to see if the parts and wires are mounted and connected properly, and if the connections at the soldered or crimped terminals are secure. Improper installation and connections may cause excessive heat generation, fire or an electrical shock.	
If the installation platform or frame has corroded, replace it. Corroded installation platform or frame may cause the unit to fall, resulting in injury.	
Check the earth / grounding, and repair it if the equipment is not properly earthed / grounded. Improper earth / grounding may cause an electrical shock.	
Be sure to measure the insulation resistance after the repair, and make sure that the resistance is 1 MΩ or higher. Faulty insulation may cause an electrical shock.	
Be sure to check the drainage of the indoor unit after the repair. Faulty drainage may cause the water to enter the room and wet the furniture and floor.	
Do not tilt the unit when removing it. The water inside the unit may spill and wet the furniture and floor.	
Be sure to install the packing and seal on the installation frame properly. If the packing and seal are not installed properly, water may enter the room and wet the furniture and floor.	For unitary type only 

2. Used Icons

The following icons are used to attract the attention of the reader to specific information.

Icon	Type of Information	Description
 Warning	Warning	A Warning is used when there is danger of personal injury.
 Caution	Caution	A Caution is used when there is danger that the reader, through incorrect manipulation, may damage equipment, lose data, get an unexpected result or has to restart (part of) a procedure.
 Note:	Note	A Note provides information that is not indispensable, but may nevertheless be valuable to the reader, such as tips and tricks.
	Reference	A Reference guides the reader to other places in this binder or in this manual, where he/she will find additional information on a specific topic.

Part 1

List of Functions

1. Functions.....2

1. Functions

Category	Functions	CTXS07LVJU	FTXS09/12/15/18/24LVJU	Category	Functions	CTXS07LVJU	FTXS09/12/15/18/24LVJU
Basic Function	Inverter (with inverter power control)	●	●	Health & Clean	Air-purifying filter	—	—
	Operation limit for cooling (°CDB)	—	—		Photocatalytic deodorizing filter	—	—
	Operation limit for cooling (°FDB)	—	—		Air-purifying filter with photocatalytic deodorizing function	—	—
	Operation limit for heating (°CWB)	—	—		Titanium apatite photocatalytic air-purifying filter	●	●
	Operation limit for heating (°FWB)	—	—		Longlife filter (option)	—	—
	PAM control	—	—		Air filter (prefilter)	●	●
Compressor	Oval scroll compressor	—	—	Wipe-clean flat panel	●	●	
	Swing compressor	—	—	Washable grille	—	—	
	Rotary compressor	—	—	Filter cleaning indicator	—	—	
	Reluctance DC motor	—	—	Good-sleep cooling operation	—	—	
Comfortable Airflow	Power-airflow flap (horizontal blade)	—	—	Timer	WEEKLY TIMER operation	●	●
	Power-airflow dual flaps	●	●		24-hour ON/OFF TIMER	●	●
	Power-airflow diffuser	—	—		NIGHT SET mode	●	●
	Wide-angle louvers (vertical blades)	●	●	Worry Free (Reliability & Durability)	Auto-restart (after power failure)	●	●
	Auto-swing (up and down)	●	●		Self-diagnosis (R/C, LED)	●	●
	Auto-swing (right and left)	●	●		Wiring error check function	—	—
	3-D airflow	●	●		Anti-corrosion treatment of outdoor heat exchanger	—	—
COMFORT AIRFLOW operation	●	●	Flexibility	Multi-split / split type compatible indoor unit	—	●	
Comfort Control	Auto fan speed	●		●	Flexible power supply correspondence	—	—
	Indoor unit quiet operation	●		●	High ceiling application	—	—
	NIGHT QUIET mode (automatic)	—		—	Chargeless	—	—
	OUTDOOR UNIT QUIET operation (manual)	●		●	Either side drain (right or left)	●	●
	INTELLIGENT EYE operation	●		●	Power selection	—	—
	Quick warming function	—		—	°F/°C changeover R/C temperature display (factory setting: °F)	●	●
	Hot-start function	●	●	Remote Control		5-room centralized controller (option)	●
Automatic defrosting	—	—	Remote control adaptor (normal open pulse contact) (option)			●	●
Operation	Automatic operation	●	●	Remote control adaptor (normal open contact) (option)	●	●	
	Program dry function	●	●	DIII-NET compatible (adaptor) (option)	●	●	
	Fan only	●	●	Remote Controller	Wireless	●	●
Lifestyle Convenience	New POWERFUL operation (non-inverter)	—	—		Wired (option)	●	●
	Inverter POWERFUL operation	●	●				
	Priority-room setting	—	—				
	COOL / HEAT mode lock	—	—				
	HOME LEAVE operation	—	—				
	ECONO operation	●	●				
	Indoor unit ON/OFF button	●	●				
	Signal receiving sign	●	●				
R/C with back light	●	●					
Temperature display	—	—					

Note: ● : Available
 — : Not available

Category	Functions	FDXS09/12LVJU	CDXS15/18/24LVJU	Category	Functions	FDXS09/12LVJU	CDXS15/18/24LVJU	
Basic Function	Inverter (with inverter power control)	●	●	Health & Clean	Air-purifying filter	—	—	
	Operation limit for cooling (°CDB)	—	—		Photocatalytic deodorizing filter	—	—	
	Operation limit for cooling (°FDB)	—	—		Air-purifying filter with photocatalytic deodorizing function	—	—	
	Operation limit for heating (°CWB)	—	—		Titanium apatite photocatalytic air-purifying filter	—	—	
	Operation limit for heating (°FWB)	—	—		Longlife filter (option)	—	—	
	PAM control	—	—		Air filter (prefilter)	●	●	
Compressor	Oval scroll compressor	—	—		Wipe-clean flat panel	—	—	
	Swing compressor	—	—		Washable grille	—	—	
	Rotary compressor	—	—		Filter cleaning indicator	—	—	
	Reluctance DC motor	—	—		Good-sleep cooling operation	—	—	
Comfortable Airflow	Power-airflow flap (horizontal blade)	—	—	Timer	WEEKLY TIMER operation	—	—	
	Power-airflow dual flaps	—	—		24-hour ON/OFF TIMER	●	●	
	Power-airflow diffuser	—	—		NIGHT SET mode	●	●	
	Wide-angle louvers (vertical blades)	—	—	Worry Free (Reliability & Durability)	Auto-restart (after power failure)	●	●	
	Auto-swing (up and down)	—	—		Self-diagnosis (R/C, LED)	●	●	
	Auto-swing (right and left)	—	—		Wiring error check function	—	—	
	3-D airflow	—	—		Anti-corrosion treatment of outdoor heat exchanger	—	—	
	COMFORT AIRFLOW operation	—	—		Flexibility	Multi-split / split type compatible indoor unit	●	—
Comfort Control	Auto fan speed	●	●	Flexible power supply correspondence		—	—	
	Indoor unit quiet operation	●	●	High ceiling application		—	—	
	NIGHT QUIET mode (automatic)	—	—	Chargeless		—	—	
	OUTDOOR UNIT QUIET operation (manual)	●	●	Either side drain (right or left)		—	—	
	INTELLIGENT EYE operation	—	—	Power selection		—	—	
	Quick warming function	—	—	°F/°C changeover R/C temperature display (factory setting: °F)		●	●	
	Hot-start function	●	●			Remote Control	5-room centralized controller (option)	●
	Automatic defrosting	—	—		Remote control adaptor (normal open pulse contact) (option)		●	●
Operation	Automatic operation	●	●	Remote control adaptor (normal open contact) (option)	●	●		
	Program dry function	●	●	DIII-NET compatible (adaptor) (option)	●	●		
	Fan only	●	●	Remote Controller	Wireless (option)	●	●	
Lifestyle Convenience	New POWERFUL operation (non-inverter)	—	—		Wired (option)	●	●	
	Inverter POWERFUL operation	●	●					
	Priority-room setting	—	—					
	COOL / HEAT mode lock	—	—					
	HOME LEAVE operation	—	—					
	ECONO operation	●	●					
	Indoor unit ON/OFF button	●	●					
	Signal receiving sign	●	●					
	R/C with back light	●	●					
	Temperature display	—	—					

Note: ● : Available
— : Not available

Category	Functions	FVXS09/12/18NVJU	Category	Functions	FVXS09/12/18NVJU
Basic Function	Inverter (with inverter power control)	●	Health & Clean	Air-purifying filter	—
	Operation limit for cooling (°CDB)	—		Photocatalytic deodorizing filter	—
	Operation limit for cooling (°FDB)	—		Air-purifying filter with photocatalytic deodorizing function	—
	Operation limit for heating (°CWB)	—		Titanium apatite photocatalytic air-purifying filter	●
	Operation limit for heating (°FWB)	—		Longlife filter (option)	—
	PAM control	—		Air filter (prefilter)	●
Compressor	Oval scroll compressor	—	Wipe-clean flat panel	●	
	Swing compressor	—	Washable grille	—	
	Rotary compressor	—	Filter cleaning indicator	—	
	Reluctance DC motor	—	Good-sleep cooling operation	—	
Comfortable Airflow	Power-airflow flap (horizontal blade)	—	Timer	WEEKLY TIMER operation	●
	Power-airflow dual flaps	—		24-hour ON/OFF TIMER	●
	Power-airflow diffuser	—		NIGHT SET mode	●
	Wide-angle louvers (vertical blades)	●	Worry Free (Reliability & Durability)	Auto-restart (after power failure)	●
	Auto-swing (up and down)	●		Self-diagnosis (R/C, LED)	●
	Auto-swing (right and left)	—		Wiring error check function	—
	3-D airflow	—		Anti-corrosion treatment of outdoor heat exchanger	—
	COMFORT AIRFLOW operation	—		Flexibility	Multi-split / split type compatible indoor unit
Comfort Control	Auto fan speed	●	Flexible power supply correspondence		—
	Indoor unit quiet operation	●	High ceiling application		—
	NIGHT QUIET mode (automatic)	—	Chargeless		—
	OUTDOOR UNIT QUIET operation (manual)	●	Either side drain (right or left)		—
	INTELLIGENT EYE operation	—	Power selection		—
	Quick warming function	—	°F/°C changeover R/C temperature display (factory setting: °F)		●
	Hot-start function	●	Remote Control	5-room centralized controller (option)	●
Automatic defrosting	—	Remote control adaptor (normal open pulse contact) (option)		●	
Operation	Automatic operation	●		Remote control adaptor (normal open contact) (option)	●
	Program dry function	●	DIII-NET compatible (adaptor) (option)	●	
	Fan only	●	Remote Controller	Wireless	●
Lifestyle Convenience	New POWERFUL operation (non-inverter)	—		Wired (option)	—
	Inverter POWERFUL operation	●			
	Priority-room setting	—			
	COOL / HEAT mode lock	—			
	HOME LEAVE operation	—			
	ECONO operation	●			
	Indoor unit ON/OFF button	●			
	Signal receiving sign	●			
	R/C with back light	●			
Temperature display	—				

Note: ● : Available
 — : Not available

Category	Functions	FFQ09/12/15/18LVJU	Category	Functions	FFQ09/12/15/18LVJU
Basic Function	Inverter (with inverter power control)	●	Health & Clean	Air-purifying filter	—
	Operation limit for cooling (°CDB)	—		Photocatalytic deodorizing filter	—
	Operation limit for cooling (°FDB)	—		Air-purifying filter with photocatalytic deodorizing function	—
	Operation limit for heating (°CWB)	—		Titanium apatite photocatalytic air-purifying filter	—
	Operation limit for heating (°FWB)	—		Longlife filter (option)	●
	PAM control	—		Air filter (prefilter)	—
Compressor	Oval scroll compressor	—	Timer	Wipe-clean flat panel	—
	Swing compressor	—		Washable grille	●
	Rotary compressor	—		Filter cleaning indicator	●
	Reluctance DC motor	—		Good-sleep cooling operation	—
Comfortable Airflow	Power-airflow flap (horizontal blade)	—	Worry Free (Reliability & Durability)	WEEKLY TIMER operation	●★2
	Power-airflow dual flaps	—		24-hour ON/OFF TIMER	—
	Power-airflow diffuser	—		72-hour ON/OFF TIMER	●★1
	Wide-angle louvers (vertical blades)	—		NIGHT SET mode	—
	Auto-swing (up and down)	●	Flexibility	Auto-restart (after power failure)	●
	Auto-swing (right and left)	—		Self-diagnosis (R/C, LED)	●
	3-D airflow	—		Wiring error check function	—
	COMFORT AIRFLOW operation	—		Anti-corrosion treatment of outdoor heat exchanger	—
Comfort Control	Auto fan speed	—	Flexibility	Multi-split / split type compatible indoor unit	—
	Indoor unit quiet operation	—		Flexible power supply correspondence	—
	NIGHT QUIET mode (automatic)	—		High ceiling application	—
	OUTDOOR UNIT QUIET operation (manual)	—		Chargeless	—
	INTELLIGENT EYE operation	—		Either side drain (right or left)	—
	Quick warming function	—		Power selection	—
	Hot-start function	●		°F/°C changeover R/C temperature display (factory setting: °F)	●★2
	Automatic defrosting	—		5-room centralized controller (option)	—
Operation	Automatic operation	●	Remote Control	Remote control adaptor (normal open pulse contact) (option)	—
	Program dry function	●		Remote control adaptor (normal open contact) (option)	—
	Fan only	●		DIII-NET compatible (adaptor) (option)	●
Lifestyle Convenience	New POWERFUL operation (non-inverter)	—	Remote Controller	Wireless (option)	●
	Inverter POWERFUL operation	—		Wired (option)	●
	Priority-room setting	—			
	COOL / HEAT mode lock	—			
	HOME LEAVE operation	—			
	ECONO operation	—			
	Indoor unit ON/OFF button	●★1			
	Signal receiving sign	●★1			
	R/C with back light	●★2			
	Temperature display	—			

Note: ● : Available
— : Not available

★1: With wireless remote controller
★2: With wired remote controller

Category	Functions			Category	Functions		
		2MXS18NMVJU	3MXS24NMVJU 4MXS36NMVJU			2MXS18NMVJU	3MXS24NMVJU 4MXS36NMVJU
Basic Function	Inverter (with inverter power control)	●	●	Health & Clean	Air-purifying filter	—	—
	Operation limit for cooling (°CDB)	-10 ~ 46	-10 ~ 46		Photocatalytic deodorizing filter	—	—
	Operation limit for cooling (°FDB)	14 ~ 114.8	14 ~ 114.8		Air-purifying filter with photocatalytic deodorizing function	—	—
	Operation limit for heating (°CWB)	-15 ~ 15.5	-15 ~ 15.5		Titanium apatite photocatalytic air-purifying filter	—	—
	Operation limit for heating (°FWB)	5 ~ 59.9	5 ~ 59.9		Longlife filter (option)	—	—
	PAM control	●	●		Air filter (prefilter)	—	—
Compressor	Oval scroll compressor	—	—	Timer	Wipe-clean flat panel	—	—
	Swing compressor	●	●		Washable grille	—	—
	Rotary compressor	—	—		Filter cleaning indicator	—	—
	Reluctance DC motor	●	●		Good-sleep cooling operation	—	—
Comfortable Airflow	Power-airflow flap (horizontal blade)	—	—	Worry Free (Reliability & Durability)	WEEKLY TIMER operation	—	—
	Power-airflow dual flaps	—	—		24-hour ON/OFF timer	—	—
	Power-airflow diffuser	—	—		NIGHT SET mode	—	—
	Wide-angle louvers (vertical blades)	—	—	Auto-restart (after power failure)	—	—	
	Auto-swing (up and down)	—	—	Self-diagnosis (R/C, LED)	●	●	
	Auto-swing (right and left)	—	—	Wiring error check function	●	●	
	3-D airflow	—	—	Anti-corrosion treatment of outdoor heat exchanger	●	●	
Comfort Control	COMFORT AIRFLOW operation	—	—	Flexibility	Multi-split / split type compatible indoor unit	—	—
	Auto fan speed	—	—		Flexible power supply correspondence	—	—
	Indoor unit quiet operation	—	—		High ceiling application	—	—
	NIGHT QUIET mode (automatic)	●	●		Chargeless	98.4 ft (30 m)	131.6 ft (40 m)
	OUTDOOR UNIT QUIET operation (manual)	●	●		Either side drain (right or left)	—	—
	INTELLIGENT EYE operation	—	—		Power selection	—	—
	Quick warming function	●	●		°F/°C changeover R/C temperature display (factory setting: °F)	—	—
	Hot-start function	—	—				
Operation	Automatic defrosting	●	●	Remote Control	5-room centralized controller (option)	—	—
	Automatic operation	—	—		Remote control adaptor (normal open pulse contact) (option)	—	—
	Program dry function	—	—		Remote control adaptor (normal open contact) (option)	—	—
Lifestyle Convenience	Fan only	—	—	Remote Controller	DIII-NET compatible (adaptor) (option)	—	—
	New POWERFUL operation (non-inverter)	—	—		Wireless	—	—
	Inverter POWERFUL operation	—	—		Wired (option)	—	—
	Priority-room setting	●	●				
	COOL / HEAT mode lock	●	●				
	HOME LEAVE operation	—	—				
	ECONO operation	—	—				
	Indoor unit ON/OFF button	—	—				
	Signal receiving sign	—	—				
R/C with back light	—	—					
Temperature display	—	—					

Note: ● : Available
 — : Not available

Part 2 Specifications

1. Indoor Unit.....	8
2. Outdoor Unit.....	14

1. Indoor Unit

60 Hz, 208 - 230 V

Model			CTXS07LVJU			
			Cooling		Heating	
Rated Capacity			7 kBtu/h Class			
Front Panel Color			White			
Airflow Rate	H	cfm (m ³ /min)	332 (9.4)		350 (9.9)	
	M		261 (7.4)		290 (8.2)	
	L		194 (5.5)		233 (6.6)	
	SL		145 (4.1)		219 (6.2)	
Fan	Type		Cross Flow Fan			
	Motor Output	W	23			
	Speed	Steps	5 Steps, Quiet, Auto			
Air Direction Control			Right, Left, Horizontal, Downward			
Air Filter			Removable, Washable, Mildew Proof			
Running Current (Rated)		A	0.09 - 0.08		0.11 - 0.10	
Power Consumption (Rated)		W	18 - 18		21 - 21	
Power Factor (Rated)		%	96.2 - 97.8		91.8 - 91.3	
Temperature Control			Microcomputer Control			
Dimensions (H x W x D)		in. (mm)	11-5/8 x 31-1/2 x 8-7/16 (295 x 800 x 215)			
Packaged Dimensions (H x W x D)		in. (mm)	10-13/16 x 34-1/4 x 14-7/16 (274 x 870 x 366)			
Weight (Mass)		Lbs (kg)	20 (9)			
Gross Weight (Gross Mass)		Lbs (kg)	29 (13)			
Sound Pressure Level	H / M / L / SL	dB(A)	38 / 32 / 25 / 22		38 / 33 / 28 / 25	
Sound Power Level		dB	54		54	
Heat Insulation			Both Liquid and Gas Pipes			
Piping Connections	Liquid	in. (mm)	φ 1/4 (φ 6.4)			
	Gas	in. (mm)	φ 3/8 (φ 9.5)			
	Drain	in. (mm)	φ 5/8 (φ 16.0)			
Drawing No.			3D075490			

Model			FTXS09LVJU		FTXS12LVJU	
			Cooling	Heating	Cooling	Heating
Rated Capacity			9 kBtu/h Class		12 kBtu/h Class	
Front Panel Color			White			
Airflow Rate	H	cfm (m ³ /min)	381 (10.8)		403 (11.4)	
	M		279 (7.9)		307 (8.7)	
	L		194 (5.5)		205 (5.8)	
	SL		145 (4.1)		155 (4.4)	
Fan	Type		Cross Flow Fan		Cross Flow Fan	
	Motor Output	W	23		23	
	Speed	Steps	5 Steps, Quiet, Auto		5 Steps, Quiet, Auto	
Air Direction Control			Right, Left, Horizontal, Downward		Right, Left, Horizontal, Downward	
Air Filter			Removable, Washable, Mildew Proof		Removable, Washable, Mildew Proof	
Running Current (Rated)		A	0.09 - 0.08		0.13 - 0.12	
Power Consumption (Rated)		W	18 - 18		26 - 26	
Power Factor (Rated)		%	96.2 - 97.8		96.2 - 94.2	
Temperature Control			Microcomputer Control		Microcomputer Control	
Dimensions (H x W x D)		in. (mm)	11-5/8 x 31-1/2 x 8-7/16 (295 x 800 x 215)		11-5/8 x 31-1/2 x 8-7/16 (295 x 800 x 215)	
Packaged Dimensions (H x W x D)		in. (mm)	10-13/16 x 34-1/4 x 14-7/16 (274 x 870 x 366)		10-13/16 x 34-1/4 x 14-7/16 (274 x 870 x 366)	
Weight (Mass)		Lbs (kg)	20 (9)		22 (10)	
Gross Weight (Gross Mass)		Lbs (kg)	29 (13)		31 (14)	
Sound Pressure Level	H / M / L / SL	dB(A)	41 / 33 / 25 / 22		45 / 37 / 29 / 23	
Sound Power Level		dB	57		61	
Heat Insulation			Both Liquid and Gas Pipes		Both Liquid and Gas Pipes	
Piping Connections	Liquid	in. (mm)	φ 1/4 (φ 6.4)		φ 1/4 (φ 6.4)	
	Gas	in. (mm)	φ 3/8 (φ 9.5)		φ 3/8 (φ 9.5)	
	Drain	in. (mm)	φ 5/8 (φ 16.0)		φ 5/8 (φ 16.0)	
Drawing No.			3D075491		3D075492	

Conversion Formulae
kcal/h = kW × 860
Btu/h = kW × 3412
cfm = m ³ /min × 35.3

60 Hz, 208 - 230 V

Model			FTXS15LVJU		FTXS18LVJU	
			Cooling	Heating	Cooling	Heating
Rated Capacity			15 kBtu/h Class		18 kBtu/h Class	
Front Panel Color			White		White	
Airflow Rate	H	cfm (m ³ /min)	568 (16.1)	593 (16.8)	583 (16.5)	625 (17.7)
	M		477 (13.5)	505 (14.3)	484 (13.7)	526 (14.9)
	L		385 (10.9)	417 (11.8)	385 (10.9)	431 (12.2)
	SL		360 (10.2)	371 (10.5)	360 (10.2)	399 (11.3)
Fan	Type		Cross Flow Fan		Cross Flow Fan	
	Motor Output	W	48		48	
	Speed	Steps	5 Steps, Quiet, Auto		5 Steps, Quiet, Auto	
Air Direction Control			Right, Left, Horizontal, Downward		Right, Left, Horizontal, Downward	
Air Filter			Removable, Washable, Mildew Proof		Removable, Washable, Mildew Proof	
Running Current (Rated)	A		0.31 - 0.29	0.31 - 0.29	0.32 - 0.30	0.32 - 0.30
Power Consumption (Rated)	W		38 - 38	38 - 38	38 - 38	38 - 38
Power Factor (Rated)	%		58.9 - 57.0	58.9 - 57.0	57.1 - 55.1	57.1 - 55.1
Temperature Control			Microcomputer Control		Microcomputer Control	
Dimensions (H x W x D)	in. (mm)		13-3/8 x 41-5/16 x 9-3/4 (340 x 1,050 x 248)		13-3/8 x 41-5/16 x 9-3/4 (340 x 1,050 x 248)	
Packaged Dimensions (H x W x D)	in. (mm)		13 x 45-11/16 x 16-7/8 (331 x 1,160 x 429)		13 x 45-11/16 x 16-7/8 (331 x 1,160 x 429)	
Weight (Mass)	Lbs (kg)		31 (14)		31 (14)	
Gross Weight (Gross Mass)	Lbs (kg)		44 (20)		44 (20)	
Sound Pressure Level	H / M / L / SL	dB(A)	45 / 40 / 35 / 32	43 / 38 / 33 / 30	46 / 41 / 36 / 33	45 / 40 / 35 / 32
Sound Power Level		dB	61	59	62	61
Heat Insulation			Both Liquid and Gas Pipes		Both Liquid and Gas Pipes	
Piping Connections	Liquid	in. (mm)	φ 1/4 (φ 6.4)		φ 1/4 (φ 6.4)	
	Gas	in. (mm)	φ 1/2 (φ 12.7)		φ 1/2 (φ 12.7)	
	Drain	in. (mm)	φ 5/8 (φ 16.0)		φ 5/8 (φ 16.0)	
Drawing No.			3D075043		3D075044	

Model			FTXS24LVJU	
			Cooling	Heating
Rated Capacity			24 kBtu/h Class	
Front Panel Color			White	
Airflow Rate	H	cfm (m ³ /min)	643 (18.2)	699 (19.8)
	M		494 (14.0)	572 (16.2)
	L		350 (9.9)	445 (12.6)
	SL		328 (9.3)	403 (11.4)
Fan	Type		Cross Flow Fan	
	Motor Output	W	48	
	Speed	Steps	5 Steps, Quiet, Auto	
Air Direction Control			Right, Left, Horizontal, Downward	
Air Filter			Removable, Washable, Mildew Proof	
Running Current (Rated)	A		0.57 - 0.51	0.57 - 0.51
Power Consumption (Rated)	W		69 - 68	69 - 68
Power Factor (Rated)	%		58.2 - 58.0	58.2 - 58.0
Temperature Control			Microcomputer Control	
Dimensions (H x W x D)	in. (mm)		13-3/8 x 41-5/16 x 9-3/4 (340 x 1,050 x 248)	
Packaged Dimensions (H x W x D)	in. (mm)		13 x 45-11/16 x 16-7/8 (331 x 1,160 x 429)	
Weight (Mass)	Lbs (kg)		31 (14)	
Gross Weight (Gross Mass)	Lbs (kg)		46 (21)	
Sound Pressure Level	H / M / L / SL	dB(A)	51 / 44 / 37 / 34	48 / 42 / 37 / 34
Sound Power Level		dB	67	64
Heat Insulation			Both Liquid and Gas Pipes	
Piping Connections	Liquid	in. (mm)	φ 1/4 (φ 6.4)	
	Gas	in. (mm)	φ 5/8 (φ 15.9)	
	Drain	in. (mm)	φ 5/8 (φ 16.0)	
Drawing No.			3D075045	

Conversion Formulae
 kcal/h = kW x 860
 Btu/h = kW x 3412
 cfm = m³/min x 35.3

60 Hz, 208 - 230 V

Model			FDXS09LVJU		FDXS12LVJU	
			Cooling	Heating	Cooling	Heating
Rated Capacity			9 kBtu/h Class		12 kBtu/h Class	
External Static Pressure		inAq (Pa)	0.12 (30)		0.12 (30)	
Airflow Rate	H	cfm (m ³ /min)	305 (8.6)	305 (8.6)	305 (8.6)	305 (8.6)
	M		280 (7.9)	280 (7.9)	280 (7.9)	280 (7.9)
	L		260 (7.4)	260 (7.4)	260 (7.4)	260 (7.4)
	SL		235 (6.7)	235 (6.7)	235 (6.7)	235 (6.7)
Fan	Type		Sirocco Fan		Sirocco Fan	
	Motor Output	W	62		62	
	Speed	Steps	5 Steps, Quiet, Auto		5 Steps, Quiet, Auto	
Air Filter			Removable, Washable, Mildew Proof		Removable, Washable, Mildew Proof	
Running Current (Rated)		A	0.58 - 0.52	0.58 - 0.52	0.58 - 0.52	0.58 - 0.52
Power Consumption (Rated)		W	72 - 72	72 - 72	72 - 72	72 - 72
Power Factor (Rated)		%	59.7 - 60.2	59.7 - 60.2	59.7 - 60.2	59.7 - 60.2
Temperature Control			Microcomputer Control		Microcomputer Control	
Dimensions (H x W x D)		in. (mm)	7-7/8 x 27-9/16 x 24-7/16 (200 x 700 x 620)		7-7/8 x 27-9/16 x 24-7/16 (200 x 700 x 620)	
Packaged Dimensions (H x W x D)		in. (mm)	10-13/16 x 36-5/16 x 30-1/4 (274 x 923 x 768)		10-13/16 x 36-5/16 x 30-1/4 (274 x 923 x 768)	
Weight (Mass)		Lbs (kg)	47 (21)		47 (21)	
Gross Weight (Gross Mass)		Lbs (kg)	64 (29)		64 (29)	
Sound Pressure Level	H / M / L	dB(A)	35 / 33 / 31	35 / 33 / 31	35 / 33 / 31	35 / 33 / 31
Sound Power Level		dB	51	51	51	51
Heat Insulation			Both Liquid and Gas Pipes		Both Liquid and Gas Pipes	
Piping Connections	Liquid	in. (mm)	φ 1/4 (φ 6.4)		φ 1/4 (φ 6.4)	
	Gas	in. (mm)	φ 3/8 (φ 9.5)		φ 3/8 (φ 9.5)	
	Drain	in. (mm)	φ 25/32 (φ 20)		φ 25/32 (φ 20)	
Drawing No.			3D075493		3D075494	

Model			CDXS15LVJU		CDXS18LVJU	
			Cooling	Heating	Cooling	Heating
Rated Capacity			15 kBtu/h Class		18 kBtu/h Class	
External Static Pressure		inAq (Pa)	0.16 (40)		0.16 (40)	
Airflow Rate	H	cfm (m ³ /min)	424 (12.0)	424 (12.0)	424 (12.0)	424 (12.0)
	M		388 (11.0)	388 (11.0)	388 (11.0)	388 (11.0)
	L		353 (10.0)	353 (10.0)	353 (10.0)	353 (10.0)
	SL		297 (8.4)	297 (8.4)	297 (8.4)	297 (8.4)
Fan	Type		Sirocco Fan		Sirocco Fan	
	Motor Output	W	130		130	
	Speed	Steps	5 Steps, Quiet, Auto		5 Steps, Quiet, Auto	
Air Filter			Removable, Washable, Mildew Proof		Removable, Washable, Mildew Proof	
Running Current (Rated)		A	0.79	0.79	0.79	0.79
Power Consumption (Rated)		W	172	172	172	172
Power Factor (Rated)		%	94.4	94.4	94.4	94.4
Temperature Control			Microcomputer Control		Microcomputer Control	
Dimensions (H x W x D)		in. (mm)	7-7/8 x 35-7/16 x 24-7/16 (200 x 900 x 620)		7-7/8 x 35-7/16 x 24-7/16 (200 x 900 x 620)	
Packaged Dimensions (H x W x D)		in. (mm)	10-1/2 x 43-9/16 x 29-9/16 (266 x 1,106 x 751)		10-1/2 x 43-9/16 x 29-9/16 (266 x 1,106 x 751)	
Weight (Mass)		Lbs (kg)	60 (27)		60 (27)	
Gross Weight (Gross Mass)		Lbs (kg)	75 (34)		75 (34)	
Sound Pressure Level	H / M / L / SL	dB(A)	37 / 35 / 33 / 31	37 / 35 / 33 / 31	37 / 35 / 33 / 31	37 / 35 / 33 / 31
Heat Insulation			Both Liquid and Gas Pipes		Both Liquid and Gas Pipes	
Piping Connections	Liquid	in. (mm)	φ 1/4 (φ 6.4)		φ 1/4 (φ 6.4)	
	Gas	in. (mm)	φ 1/2 (φ 12.7)		φ 1/2 (φ 12.7)	
	Drain	in. (mm)	VP20 (O.D. φ 1-1/32 (φ 26), I.D. φ 25/32 (φ 20))		VP20 (O.D. φ 1-1/32 (φ 26), I.D. φ 25/32 (φ 20))	
Drawing No.			C: 3D075721		C: 3D075722	

<p>Conversion Formulae</p> <p>kcal/h = kW x 860</p> <p>Btu/h = kW x 3412</p> <p>cfm = m³/min x 35.3</p>
--

60 Hz, 208 - 230 V

Model			CDXS24LVJU			
			Cooling		Heating	
Rated Capacity			24 kBtu/h Class			
External Static Pressure		inAq (Pa)	0.16 (40)			
Airflow Rate	H	cfm (m ³ /min)	565 (16.0)		565 (16.0)	
	M		523 (14.8)		523 (14.8)	
	L		477 (13.5)		477 (13.5)	
	SL		395 (11.2)		395 (11.2)	
Fan	Type	Sirocco Fan				
	Motor Output	W	130			
	Speed	Steps	5 Steps, Quiet, Auto			
Air Filter			Removable, Washable, Mildew Proof			
Running Current (Rated)		A	0.79		0.79	
Power Consumption (Rated)		W	160		160	
Power Factor (Rated)		%	90.3		92.8	
Temperature Control			Microcomputer Control			
Dimensions (H x W x D)		in. (mm)	7-7/8 x 43-5/16 x 24-7/16 (200 x 1,100 x 620)			
Packaged Dimensions (H x W x D)		in. (mm)	10-1/2 x 52-1/16 x 30-1/4 (266 x 1,323 x 768)			
Weight (Mass)		Lbs (kg)	66 (30)			
Gross Weight (Gross Mass)		Lbs (kg)	84 (38)			
Sound Pressure Level	H / M / L / SL	dB(A)	38 / 36 / 34 / 32		38 / 36 / 34 / 32	
Heat Insulation			Both Liquid and Gas Pipes			
Piping Connections	Liquid	in. (mm)	φ 1/4 (φ 6.4)			
	Gas	in. (mm)	φ 5/8 (φ 15.9)			
	Drain	in. (mm)	VP20 (O.D. φ 1-1/32 (φ 26), I.D. φ 25/32 (φ 20))			
Drawing No.			3D080590			

Model			FVXS09NVJU		FVXS12NVJU	
			Cooling	Heating	Cooling	Heating
Rated Capacity			9 kBtu/h Class		12 kBtu/h Class	
Front Panel Color			White		White	
Airflow Rate	H	cfm (m ³ /min)	290 (8.2)	311 (8.8)	300 (8.5)	332 (9.4)
	M		230 (6.5)	244 (6.9)	237 (6.7)	258 (7.3)
	L		169 (4.8)	177 (5.0)	173 (4.9)	184 (5.2)
	SL		145 (4.1)	155 (4.4)	159 (4.5)	166 (4.7)
Fan	Type	Turbo Fan				
	Motor Output	W	12.3		13.4	
	Speed	Steps	5 Steps, Quiet, Auto		5 Steps, Quiet, Auto	
Air Direction Control			Right, Left, Horizontal, Downward		Right, Left, Horizontal, Downward	
Air Filter			Removable, Washable, Mildew Proof		Removable, Washable, Mildew Proof	
Running Current (Rated)		A	—	—	—	—
Power Consumption (Rated)		W	—	—	—	—
Power Factor (Rated)		%	—	—	—	—
Temperature Control			Microcomputer Control		Microcomputer Control	
Dimensions (H x W x D)		in. (mm)	23-5/8 x 27-9/16 x 8-1/4 (600 x 700 x 210)		23-5/8 x 27-9/16 x 8-1/4 (600 x 700 x 210)	
Packaged Dimensions (H x W x D)		in. (mm)	27-3/8 x 30-15/16 x 11 (695 x 786 x 279)		27-3/8 x 30-15/16 x 11 (695 x 786 x 279)	
Weight (Mass)		Lbs (kg)	31 (14)		31 (14)	
Gross Weight (Gross Mass)		Lbs (kg)	40 (18)		40 (18)	
Sound Pressure Level	H / M / L / SL	dB(A)	38 / 32 / 26 / 23	38 / 32 / 26 / 23	39 / 33 / 27 / 24	39 / 33 / 27 / 24
Sound Power Level		dB	—	—	—	—
Heat Insulation			Both Liquid and Gas Pipes		Both Liquid and Gas Pipes	
Piping Connections	Liquid	in. (mm)	φ 1/4 (φ 6.4)		φ 1/4 (φ 6.4)	
	Gas	in. (mm)	φ 3/8 (φ 9.5)		φ 3/8 (φ 9.5)	
	Drain	in. (mm)	φ 13/16 (φ 20.0)		φ 13/16 (φ 20.0)	
Drawing No.			3D094867		3D094868	

Conversion Formulae
kcal/h = kW × 860
Btu/h = kW × 3412
cfm = m ³ /min × 35.3

60 Hz, 208 - 230 V

Model			FVXS18NVJU	
			Cooling	Heating
Rated Capacity			18 kBtu/h Class	
Front Panel Color			White	
Airflow Rate	H	cfm (m ³ /min)	378 (10.7)	417 (11.8)
	M		325 (9.2)	357 (10.1)
	L		275 (7.8)	300 (8.5)
	SL		233 (6.6)	251 (7.1)
Fan	Type	Turbo Fan		
	Motor Output	W	23.3	
	Speed	Steps	5 Steps, Quiet, Auto	
Air Direction Control			Right, Left, Horizontal, Downward	
Air Filter			Removable, Washable, Mildew Proof	
Running Current (Rated)		A	—	—
Power Consumption (Rated)		W	—	—
Power Factor (Rated)		%	—	—
Temperature Control			Microcomputer Control	
Dimensions (H × W × D)		in. (mm)	23-5/8 × 27-9/16 × 8-1/4 (600 × 700 × 210)	
Packaged Dimensions (H × W × D)		in. (mm)	27-3/8 × 30-15/16 × 11 (695 × 786 × 279)	
Weight (Mass)		Lbs (kg)	31 (14)	
Gross Weight (Gross Mass)		Lbs (kg)	40 (18)	
Sound Pressure Level	H / M / L / SL	dB(A)	44 / 40 / 36 / 32	45 / 40 / 36 / 32
Sound Power Level		dB	—	—
Heat Insulation			Both Liquid and Gas Pipes	
Piping Connections	Liquid	in. (mm)	φ 1/4 (φ 6.4)	
	Gas	in. (mm)	φ 1/2 (φ 12.7)	
	Drain	in. (mm)	φ 13/16 (φ 20.0)	
Drawing No.			3D094866	

Model			FFQ09LVJU		FFQ12LVJU	
			Cooling	Heating	Cooling	Heating
Rated Capacity			9 kBtu/h Class		12 kBtu/h Class	
Decoration Panel	Model	BYFQ60B3W1		BYFQ60B3W1		
	Color	White				
	Dimensions (H × W × D)		2-5/32 × 27-9/16 × 27-9/16 (55 × 700 × 700)		2-5/32 × 27-9/16 × 27-9/16 (55 × 700 × 700)	
	Weight (Mass)	Lbs (kg)	6 (2.7)			
Airflow Rate	H	cfm (m ³ /min)	318 (9.0)	318 (9.0)	353 (10.0)	353 (10.0)
	L		230 (6.5)	230 (6.5)	230 (6.5)	230 (6.5)
Fan	Type	Turbo Fan				
	Motor Output	W	55		55	
	Speed	Steps	2 Steps		2 Steps	
Air Direction Control			Horizontal, Downward		Horizontal, Downward	
Running Current (Rated)		A	0.44	0.38	0.47	0.42
Power Consumption (Rated)		W	87	76	98	89
Power Factor		%	85.8	87.0	91.3	91.8
Temperature Control			Microcomputer Control			
Dimensions (H × W × D)		in. (mm)	11-1/4 × 22-5/8 × 22-5/8 (285 × 575 × 575)		11-1/4 × 22-5/8 × 22-5/8 (285 × 575 × 575)	
Packaged Dimensions (H × W × D)		in. (mm)	14-9/16 × 27-1/16 × 26-9/16 (370 × 687 × 674)		14-9/16 × 27-1/16 × 26-9/16 (370 × 687 × 674)	
Weight (Mass)		Lbs (kg)	38.6 (17.5)			
Gross Weight (Gross Mass)		Lbs (kg)	46 (21)			
Sound Pressure Level	H / L	dB(A)	36.0 / 29.5	36.0 / 29.5	38.5 / 29.0	38.5 / 29.0
Heat Insulation			Both Liquid and Gas Pipes			
Piping Connections	Liquid	in. (mm)	φ 1/4 (φ 6.4)		φ 1/4 (φ 6.4)	
	Gas	in. (mm)	φ 3/8 (φ 9.5)		φ 3/8 (φ 9.5)	
	Drain	in. (mm)	VP20 (O.D. φ 1-1/32 (φ 26) / I.D. φ 25/32 (φ 20))		VP20 (O.D. φ 1-1/32 (φ 26) / I.D. φ 25/32 (φ 20))	
Drawing No.			3D080626A		3D080627A	

Conversion Formulae
kcal/h = kW × 860
Btu/h = kW × 3412
cfm = m ³ /min × 35.3

60 Hz, 208 - 230 V

Model			FFQ15LVJU		FFQ18LVJU	
			Cooling	Heating	Cooling	Heating
Rated Capacity			15 kBtu/h Class		18 kBtu/h Class	
Decoration Panel	Model		BYFQ60B3W1		BYFQ60B3W1	
	Color		White		White	
	Dimensions (H x W x D)		2-5/32 x 27-9/16 x 27-9/16 (55 x 700 x 700)		2-5/32 x 27-9/16 x 27-9/16 (55 x 700 x 700)	
	Weight (Mass)	Lbs (kg)	6 (2.7)		6 (2.7)	
Airflow Rate	H	cfm	424 (12.0)	424 (12.0)	530 (15.0)	530 (15.0)
	L	(m ³ /min)	283 (8.0)	283 (8.0)	353 (10.0)	353 (10.0)
Fan	Type		Turbo Fan		Turbo Fan	
	Motor Output	W	55		55	
	Speed	Steps	2 Steps		2 Steps	
Air Direction Control			Horizontal, Downward		Horizontal, Downward	
Running Current (Rated)	A	0.57	0.52	0.71	0.65	
Power Consumption (Rated)	W	112	103	140	130	
Power Factor	%	86.1	86.0	85.5	86.2	
Temperature Control			Microcomputer Control		Microcomputer Control	
Dimensions (H x W x D)	in. (mm)	11-1/4 x 22-5/8 x 22-5/8 (285 x 575 x 575)		11-1/4 x 22-5/8 x 22-5/8 (285 x 575 x 575)		
Packaged Dimensions (H x W x D)	in. (mm)	14-9/16 x 27-1/16 x 26-9/16 (370 x 687 x 674)		14-9/16 x 27-1/16 x 26-9/16 (370 x 687 x 674)		
Weight (Mass)	Lbs (kg)	38.6 (17.5)		38.6 (17.5)		
Gross Weight (Gross Mass)	Lbs (kg)	46 (21)		46 (21)		
Sound Pressure Level	H / L	dB(A)	42.5 / 31.5	42.5 / 31.5	46.0 / 37.5	46.0 / 37.5
Heat Insulation			Both Liquid and Gas Pipes		Both Liquid and Gas Pipes	
Piping Connections	Liquid	in. (mm)	φ 1/4 (φ 6.4)		φ 1/4 (φ 6.4)	
	Gas	in. (mm)	φ 1/2 (φ 12.7)		φ 1/2 (φ 12.7)	
	Drain	in. (mm)	VP20 (O.D. φ 1-1/32 (φ 26) / I.D. φ 25/32 (φ 20)		VP20 (O.D. φ 1-1/32 (φ 26) / I.D. φ 25/32 (φ 20)	
Drawing No.			3D080628A		3D080629A	

Conversion Formulae
kcal/h = kW × 860
Btu/h = kW × 3412
cfm = m ³ /min × 35.3

2. Outdoor Unit

60 Hz, 208 - 230 V

Model		2MXS18NMVJU	
		Cooling	Heating
COP ★	W/W	—	
EER ★	Btu/h-W	9.5 ~ 12.5	
SEER / HSPF		14.0 ~ 18.9	8.2 ~ 10.7
Casing Color		Ivory White	
Compressor	Type	Hermetically Sealed Swing Type	
	Model	2YC36PXD	
	Motor Output	W	
Refrigerant Oil	Model	FVC50K	
	Charge	oz (L)	
Refrigerant	Type	R-410A	
	Charge	Lbs (kg)	
Airflow Rate	H	2,150	
	M	2,150	
	L	1,953	
	H	60.9	
	M	60.9	
	L	55.3	
Fan	Type	Propeller	
	Motor Output	W	
	Running Current	A	
	Power Consumption	W	
Starting Current	A	14.0	
Dimension (H × W × D)	in. (mm)	28-15/16 × 34-1/4 × 12-5/8 (735 × 870 × 320)	
Packaged Dimension (H × W × D)	in. (mm)	31-7/8 × 41-9/16 × 17-1/2 (810 × 1,056 × 444)	
Weight (Mass)	Lbs (kg)	123 (56)	
Gross Weight (Gross Mass)	Lbs (kg)	141 (64)	
Sound Pressure Level	dB(A)	50	51
Piping Connections	Liquid	in. (mm)	
	Gas	in. (mm)	
	Drain	in. (mm)	
Heat Insulation		Both Liquid and Gas Pipes	
No. of Wiring Connections		3 for Power Supply, 4 for Interunit Wiring	
Max. Interunit Piping Length	ft (m)	164 (50) (for Total of Each Room)	
		82 (25) (for One Room)	
Amount of Additional Charge of Refrigerant	oz/ft (g/m)	0.21 (20) (98-3/8 ft (30 m) or more)	
Max. Installation Height Difference	ft (m)	49-1/4 (15) (between Indoor Unit and Outdoor Unit)	
		24-5/8 (7.5) (between Indoor Units)	
Drawing No.		3D093257	

- Notes:**
- ★ Max.: for the combination of CTXS, FTXS series indoor units
Min.: for the combination of CDXS, FDXS series indoor units
 - The data are based on the conditions shown in the table below.

Cooling	Indoor ; 80°FDB (26.7°CDB) / 67°FWB (19.4°CWB) Outdoor ; 95°FDB (35°CDB) / 75°FWB (24°CWB)
Heating	Indoor ; 70°FDB (21°CDB) / 60°FWB (15.6°CWB) Outdoor ; 47°FDB (8.3°CDB) / 43°FWB (6°CWB)
Piping Length	25 ft (7.5 m)

Conversion Formulae

kcal/h = kW × 860
Btu/h = kW × 3412
cfm = m³/min × 35.3

60 Hz, 208 - 230 V

Model		3MXS24NMVJU	
		Cooling	Heating
COP ★	W/W	—	
EER ★	Btu/h-W	9.7 ~ 12.7	
SEER / HSPF		14.0 ~ 17.9	
Casing Color		Ivory White	
Compressor	Type	Hermetically Sealed Swing Type	
	Model	2YC63AAXD	
	Motor Output	W	1,920
Refrigerant Oil	Model	FVC50K	
	Charge	oz (L)	29.8 (0.85)
Refrigerant	Type	R-410A	
	Charge	Lbs (kg)	6.17 (2.8)
Airflow Rate	H	cfm	2,094
	M		2,094
	L		1,981
	H	m³/min	59.3
	M		59.3
	L		56.1
Fan	Type	Propeller	
	Motor Output	W	51
	Running Current	A	H: 0.28 / M: 0.28 / L: 0.26
	Power Consumption	W	H: 63 / M: 63 / L: 59
Starting Current	A	15.5	
Dimension (H × W × D)	in. (mm)	28-15/16 × 34-1/4 × 12-5/8 (735 × 870 × 320)	
Packaged Dimension (H × W × D)	in. (mm)	31-7/8 × 41-9/16 × 17-1/2 (810 × 1,056 × 444)	
Weight (Mass)	Lbs (kg)	137 (62)	
Gross Weight (Gross Mass)	Lbs (kg)	154 (70)	
Sound Pressure Level	dB(A)	52	54
Piping Connections	Liquid	in. (mm)	φ 1/4 × 3 (φ 6.4 × 3)
	Gas	in. (mm)	φ 3/8 × 1, φ 1/2 × 2 (φ 9.5 × 1, φ 12.7 × 2)
	Drain	in. (mm)	φ 11/16 (φ 17.5)
Heat Insulation		Both Liquid and Gas Pipes	
No. of Wiring Connections		3 for Power Supply, 4 for Interunit Wiring	
Max. Interunit Piping Length	ft (m)	230 (70) (for Total of Each Room)	
		82 (25) (for One Room)	
Amount of Additional Charge of Refrigerant	oz/ft (g/m)	0.21 (20) (131-5/8 ft (40 m) or more)	
Max. Installation Height Difference	ft (m)	49-1/4 (15) (between Indoor Unit and Outdoor Unit)	
		24-5/8 (7.5) (between Indoor Units)	
Drawing No.		3D093259	

- Notes:**
- ★ Max.: for the combination of CTXS, FTXS series indoor units
Min.: for the combination of CDXS, FDXS series indoor units
 - The data are based on the conditions shown in the table below.

Cooling	Indoor ; 80°FDB (26.7°CDB) / 67°FWB (19.4°CWB) Outdoor ; 95°FDB (35°CDB) / 75°FWB (24°CWB)
Heating	Indoor ; 70°FDB (21°CDB) / 60°FWB (15.6°CWB) Outdoor ; 47°FDB (8.3°CDB) / 43°FWB (6°CWB)
Piping Length	25 ft (7.5 m)

Conversion Formulae

kcal/h = kW × 860
Btu/h = kW × 3412
cfm = m³/min × 35.3

60 Hz, 208 - 230 V

Model		4MXS36NMVJU	
		Cooling	Heating
COP ★	W/W	—	
EER ★	Btu/h-W	7.9 - 9.2	
SEER / HSPF		14.0 - 17.7	
Casing Color		Ivory White	
Compressor	Type	Hermetically Sealed Swing Type	
	Model	2YC63AAXD	
	Motor Output	W	1,920
Refrigerant Oil	Model	FVC50K	
	Charge	oz (L)	29.8 (0.85)
Refrigerant	Type	R-410A	
	Charge	Lbs (kg)	6.17 (2.8)
Airflow Rate	H	cfm	2,613
	M		2,440
	L		1,727
	H	m³/min	74.0
	M		69.1
	L		59.3
Fan	Type	Propeller	
	Motor Output	W	75
	Running Current	A	H: 0.52 / M: 0.40 / L: 0.27
	Power Consumption	W	H: 116 / M: 90 / L: 61
Starting Current	A	17.5	
Dimension (H × W × D)	in. (mm)	28-15/16 × 34-1/4 × 12-5/8 (735 × 870 × 320)	
Packaged Dimension (H × W × D)	in. (mm)	31-7/8 × 41-9/16 × 17-1/2 (810 × 1,056 × 444)	
Weight (Mass)	Lbs (kg)	139 (63)	
Gross Weight (Gross Mass)	Lbs (kg)	157 (71)	
Sound Pressure Level	dB(A)	54	56
Piping Connections	Liquid	in. (mm)	φ 1/4 × 4 (φ 6.4 × 4)
	Gas	in. (mm)	φ 3/8 × 1, φ 1/2 × 2, φ 5/8 × 1 (φ 9.5 × 1, φ 12.7 × 2, φ 15.9 × 1)
	Drain	in. (mm)	φ 11/16 (φ 17.5)
Heat Insulation		Both Liquid and Gas Pipes	
No. of Wiring Connections		3 for Power Supply, 4 for Interunit Wiring	
Max. Interunit Piping Length	ft (m)	230 (70) (for Total of Each Room)	
		82 (25) (for One Room)	
Amount of Additional Charge of Refrigerant	oz/ft (g/m)	0.21 (20) (131-5/8 ft (40 m) or more)	
Max. Installation Height Difference	ft (m)	49-1/4 (15) (between Indoor Unit and Outdoor Unit)	
		24-5/8 (7.5) (between Indoor Units)	
Drawing No.		3D093260	

- Notes:**
- ★ Max.: for the combination of CTXS, FTXS series indoor units
Min.: for the combination of CDXS, FDXS series indoor units
 - The data are based on the conditions shown in the table below.

Cooling	Indoor ; 80°FDB (26.7°CDB) / 67°FWB (19.4°CWB) Outdoor ; 95°FDB (35°CDB) / 75°FWB (24°CWB)
Heating	Indoor ; 70°FDB (21°CDB) / 60°FWB (15.6°CWB) Outdoor ; 47°FDB (8.3°CDB) / 43°FWB (6°CWB)
Piping Length	25 ft (7.5 m)

Conversion Formulae
kcal/h = kW × 860
Btu/h = kW × 3412
cfm = m³/min × 35.3

Part 3

Printed Circuit Board

Connector Wiring Diagram

1. Indoor Unit.....	18
1.1 CTXS07LVJU, FTXS09/12LVJU	18
1.2 FTXS15/18/24LVJU	20
1.3 FDXS09/12LVJU, CDXS15/18/24LVJU	22
1.4 FVXS09/12/18NVJU.....	24
1.5 FFQ09/12/15/18LVJU	26
2. Wired Remote Controller.....	27
2.1 BRC1E71	27
2.2 BRC1E72/73	28
3. Wireless Remote Controller	29
3.1 BRC7E830	29
4. Outdoor Unit.....	30

1. Indoor Unit

1.1 CTXS07LVJU, FTXS09/12LVJU

Control PCB (PCB1)

- | | |
|--------------------|--|
| 1) S1 | Connector for DC fan motor |
| 2) S21 | Connector for centralized control (HA) |
| 3) S25 | Connector for INTELLIGENT EYE sensor PCB |
| 4) S32 | Indoor heat exchanger thermistor |
| 5) S41 | Connector for swing motors |
| 6) S46 | Connector for display PCB |
| 7) S47 | Connector for signal receiver PCB |
| 8) H1, H2, H3, FG | Connector for terminal board |
| 9) JA | Address setting jumper |
| | * Refer to page 189 for detail. |
| 10) JB | Fan speed setting when compressor stops for thermostat OFF |
| | * Refer to page 191 for detail. |
| 11) JC | Power failure recovery function (auto-restart) |
| | * Refer to page 191 for detail. |
| 12) LED A | LED for service monitor (green) |
| 13) FU1 (F1U), FU2 | Fuse (3.15 A, 250 V) |
| 14) V1 | Varistor |

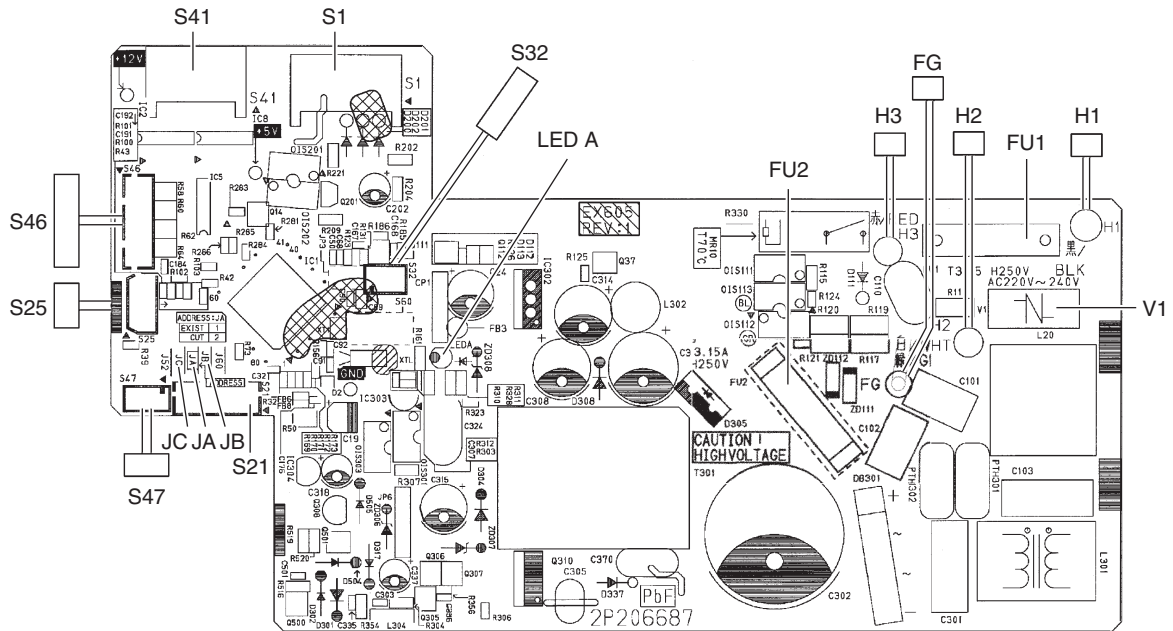

2P206687-4



Caution Replace the PCB if you accidentally cut the jumpers other than JA, JB, and JC.
Jumpers are necessary for electronic circuit. Improper operation may occur if you cut any of them.



Note: The symbols in the parenthesis are the names on the appropriate wiring diagram.

Signal Receiver PCB (PCB2)

- 1) S48 Connector for control PCB

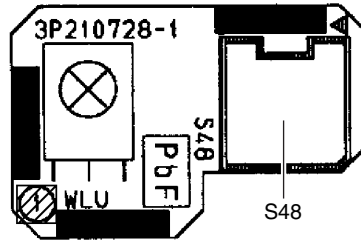

3P210728-1

Display PCB (PCB3)

- 1) S49 Connector for control PCB
- 2) SW1 Forced cooling operation **ON/OFF** button
- 3) LED1 (H1P) LED for operation (green)
- 4) LED2 (H2P) LED for timer (yellow)
- 5) LED3 (H3P) LED for INTELLIGENT EYE (green)
- 6) RTH1 (R1T) Room temperature thermistor

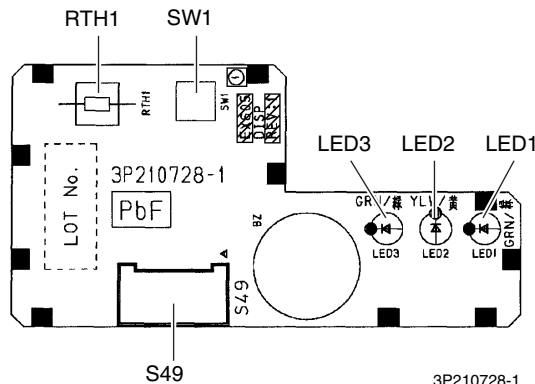

3P210728-1

INTELLIGENT EYE Sensor PCB (PCB4)

- 1) S26 Connector for control PCB

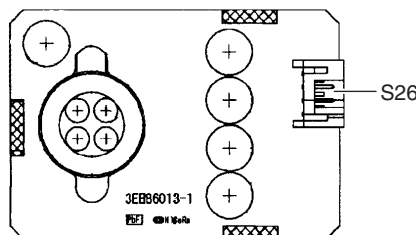

3EB86013-1

Note: The symbols in the parenthesis are the names on the appropriate wiring diagram.

1.2 FTXS15/18/24LVJU

Control PCB (PCB1)

- | | |
|--------------------|---|
| 1) S1 | Connector for DC fan motor |
| 2) S21 | Connector for centralized control (HA) |
| 3) S25 | Connector for INTELLIGENT EYE sensor PCB |
| 4) S32 | Indoor heat exchanger thermistor |
| 5) S41 | Connector for swing motors |
| 6) S46 | Connector for display PCB |
| 7) S47 | Connector for signal receiver PCB |
| 8) H1, H2, H3, FG | Connector for terminal board |
| 9) JA | Address setting jumper
* Refer to page 189 for detail. |
| 10) JB | Fan speed setting when compressor stops for thermostat OFF
* Refer to page 191 for detail. |
| 11) JC | Power failure recovery function (auto-restart)
* Refer to page 191 for detail. |
| 12) LED A | LED for service monitor (green) |
| 13) FU1 (F1U), FU2 | Fuse (3.15 A, 250 V) |
| 14) V1 | Varistor |

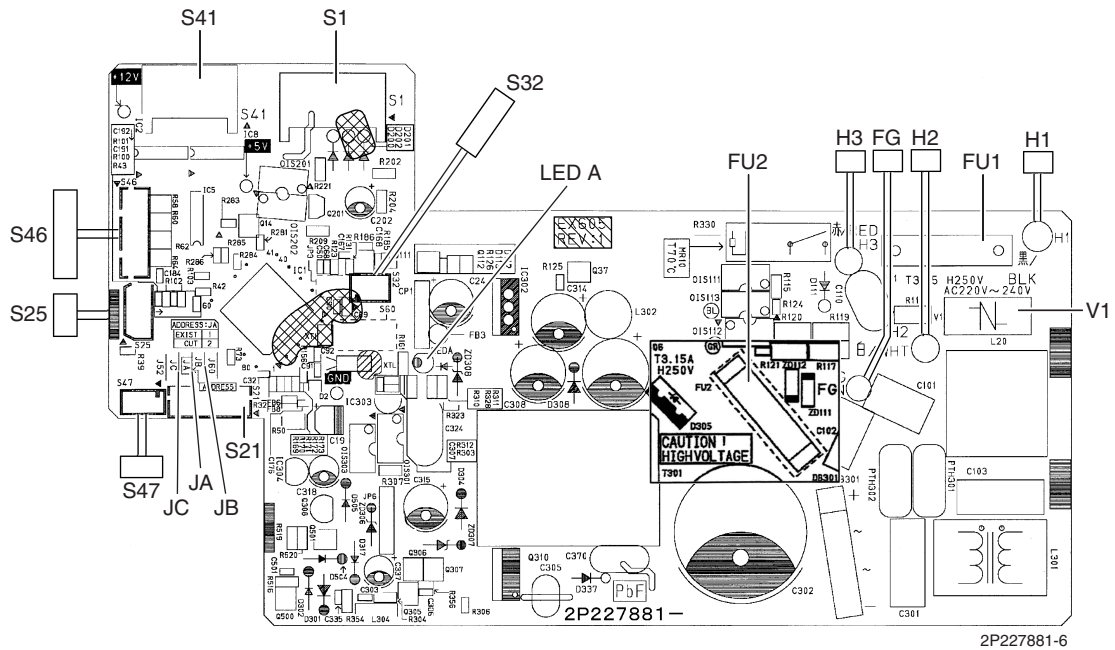

Caution

Replace the PCB if you accidentally cut the jumpers other than JA, JB, and JC.

Jumpers are necessary for electronic circuit. Improper operation may occur if you cut any of them.



Note:

The symbols in the parenthesis are the names on the appropriate wiring diagram.

Signal Receiver PCB (PCB2)

- 1) S48 Connector for control PCB

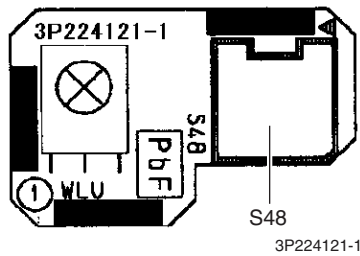

Display PCB (PCB3)

- 1) S49 Connector for control PCB
- 2) SW1 Forced cooling operation **ON/OFF** button
- 3) LED1 (H1P) LED for operation (green)
- 4) LED2 (H2P) LED for timer (yellow)
- 5) LED3 (H3P) LED for INTELLIGENT EYE (green)
- 6) RTH1 (R1T) Room temperature thermistor

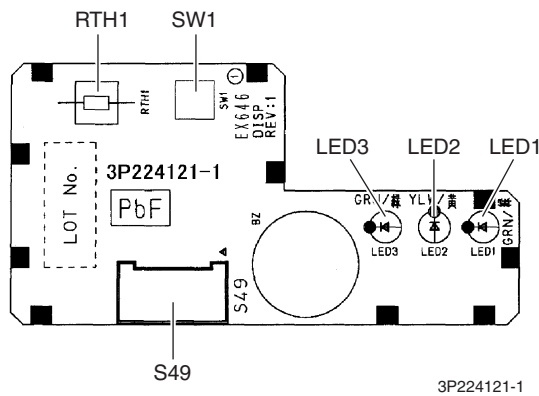

INTELLIGENT EYE Sensor PCB (PCB4)

- 1) S36 Connector for control PCB

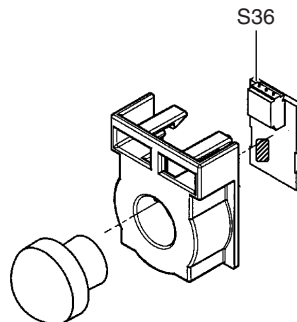

3P227885-1

i Note: The symbols in the parenthesis are the names on the appropriate wiring diagram.

1.3 FDXS09/12LVJU, CDXS15/18/24LVJU

Control PCB (A1P)

- | | |
|---------------|--|
| 1) S1 | Connector for AC fan motor |
| 2) S7 | Connector for AC fan motor (Hall IC) |
| 3) S21 | Connector for centralized control (HA) |
| 4) S26 | Connector for display PCB |
| 5) S32 | Connector for indoor heat exchanger thermistor |
| 6) H1, H2, H3 | Connector for terminal board |
| 7) FG (GND) | Connector for terminal board (ground) |
| 8) JA | Address setting jumper |
| | * Refer to page 189 for detail. |
| 9) JB | Fan speed setting when compressor stops for thermostat OFF |
| | * Refer to page 191 for detail. |
| 10) JC | Power failure recovery function (auto-restart) |
| | * Refer to page 191 for detail. |
| 11) LED A | LED for service monitor (green) |
| 12) FU1 (F1U) | Fuse (3.15 A, 250 V) |
| 13) V1 (V1TR) | Varistor |

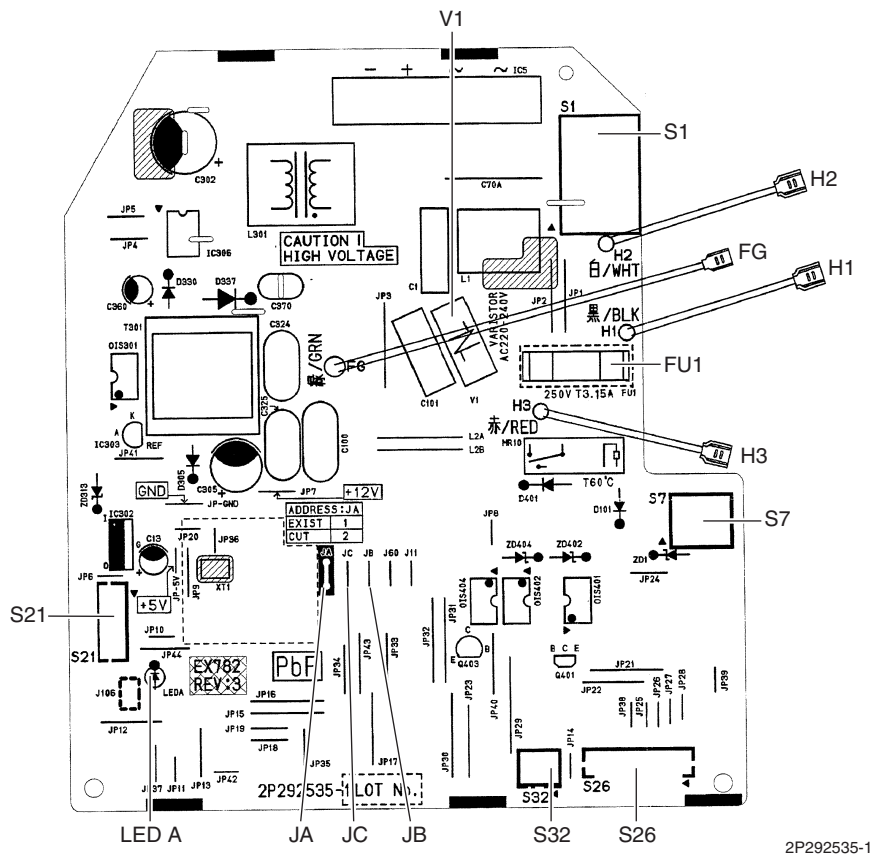

Caution **Replace the PCB if you accidentally cut the jumpers other than JA, JB, and JC.**
Jumpers are necessary for electronic circuit. Improper operation may occur if you cut any of them.



Note: The symbols in the parenthesis are the names on the appropriate wiring diagram.

**Display PCB
(A2P)**

- | | |
|---------------|---|
| 1) S1 | Connector for control PCB |
| 2) SW1 (S1W) | Forced cooling operation ON/OFF button |
| 3) LED2 (H2P) | LED for timer (yellow) |
| 4) LED3 (H3P) | LED for operation (green) |
| 5) RTH1 (R1T) | Room temperature thermistor |

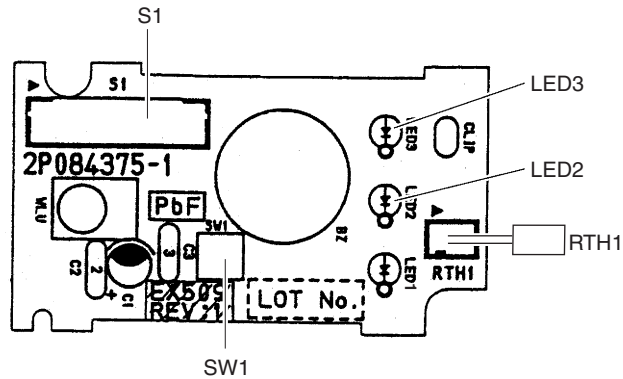

2P084375-1

★LED 1 does not function.



Note: The symbols in the parenthesis are the names on the appropriate wiring diagram.

1.4 FVXS09/12/18NVJU

Control PCB (PCB2)

- | | |
|--------------------|--|
| 1) S1 | Connector for fan motor |
| 2) S21 | Connector for centralized control (HA) |
| 3) S26 | Connector for service PCB |
| 4) S32 | Indoor heat exchanger thermistor |
| 5) S41 | Connector for lower air outlet motor |
| 6) S42 | Connector for swing motor |
| 7) S46 | Connector for display PCB |
| 8) S48 | Connector for sensor PCB |
| 9) H1, H2, H3 | Connector for terminal board |
| 10) E1 | Terminal for ground wire |
| 11) JA | Address setting jumper |
| | * Refer to page 189 for detail. |
| 12) JB | Fan speed setting when compressor stops for thermostat OFF |
| | * Refer to page 191 for detail. |
| 13) JC | Power failure recovery function |
| | * Refer to page 191 for detail. |
| 14) FU1 (F1U), FU2 | Fuse (3.15 A, 250 V) |
| 15) LED A | LED for service monitor (green) |
| 16) V1, V2 | Varistor |

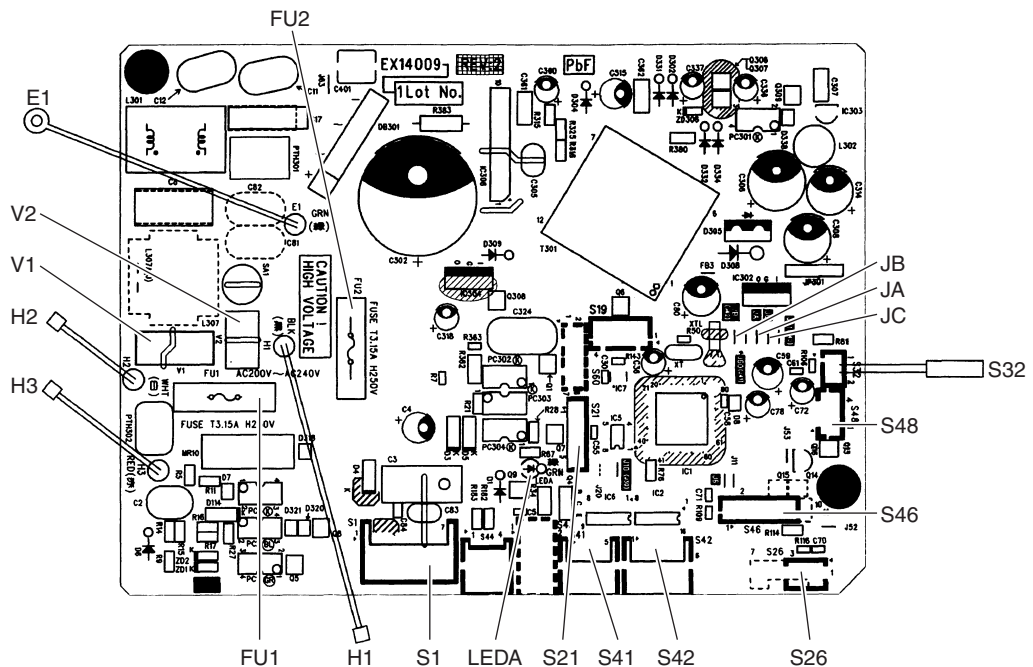

2P383711-1



Caution Replace the PCB if you accidentally cut the jumpers other than JA, JB, and JC.
Jumpers are necessary for electronic circuit. Improper operation may occur if you cut any of them.



Note: The symbols in the parenthesis are the names on the appropriate wiring diagram.

Sensor PCB (PCB1)

- 1) S49 Connector for control PCB
- 2) RTH2 (R1T) Room temperature thermistor

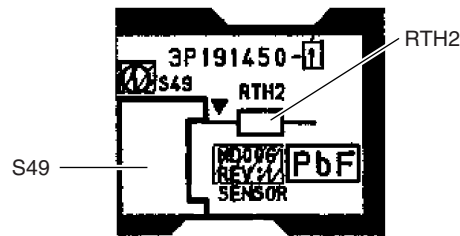

3P191450-1

Service PCB (PCB3)

- 1) S27 Connector for control PCB
- 2) SW2 (S2W)-4 Switch for upward airflow limit setting
 - * Refer to page 191 for detail.
 - * Keep the other switches as factory setting.
- 3) SW4 (S4W) Switch for airflow selection
 - * Refer to page 38 for detail.

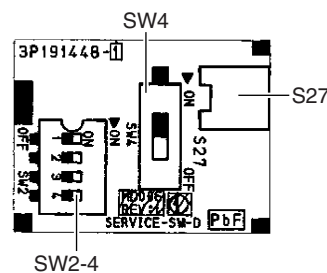

3P191448-1

Display PCB (PCB4)

- 1) S47 Connector for control PCB
- 2) SW1 (S1W) Forced cooling operation **ON/OFF** button
- 3) LED1 (H1P) LED for operation (green)
- 4) LED2 (H2P) LED for timer (yellow)

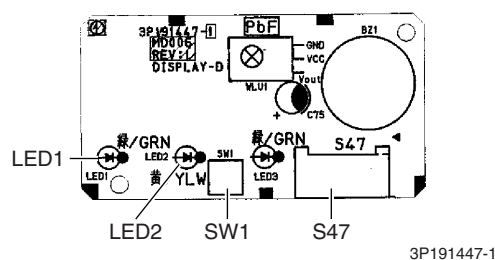

3P191447-1

★ LED3 does not function.



Note: The symbols in the parenthesis are the names on the appropriate wiring diagram.

1.5 FFQ09/12/15/18LVJU

Control PCB

- | | |
|---------------|--|
| 1) X5A | Connector for terminal board (for wired remote controller) |
| 2) X10A, X11A | Connector for transformer |
| 3) X15A | Connector for float switch |
| 4) X17A, X18A | Connector for indoor heat exchanger thermistor |
| 5) X19A | Connector for room temperature thermistor |
| 6) X20A | Connector for fan motor |
| 7) X24A | Connector for signal receiver PCB
(when the wireless remote controller is used) |
| 8) X25A | Connector for drain pump motor |
| 9) X27A | Connector for terminal board (for inter-unit wiring) |
| 10) X33A | Connector for wiring adaptor PCB (option) |
| 11) X35A | Connector for group control adaptor (option) |
| 12) X36A | Connector for swing motor |
| 13) X40A | Connector for ON/OFF input from outside (option) |
| 14) HAP | LED for service monitor (green) |
| 15) SS1 | Selector switch for emergency |

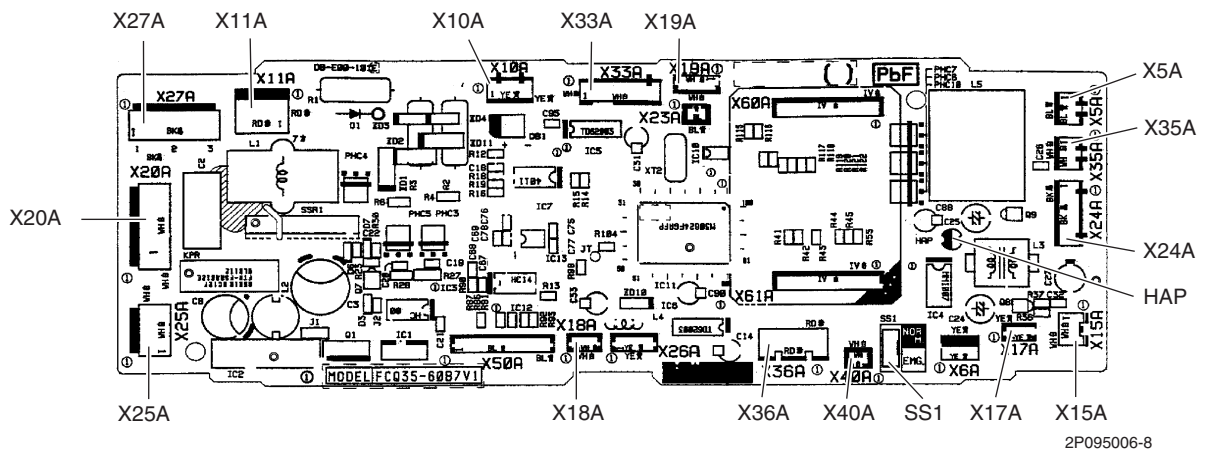

2. Wired Remote Controller

2.1 BRC1E71

Wired Remote
Controller PCB

- 1) P1, P2 Terminal for indoor unit
- 2) R1T Room temperature thermistor

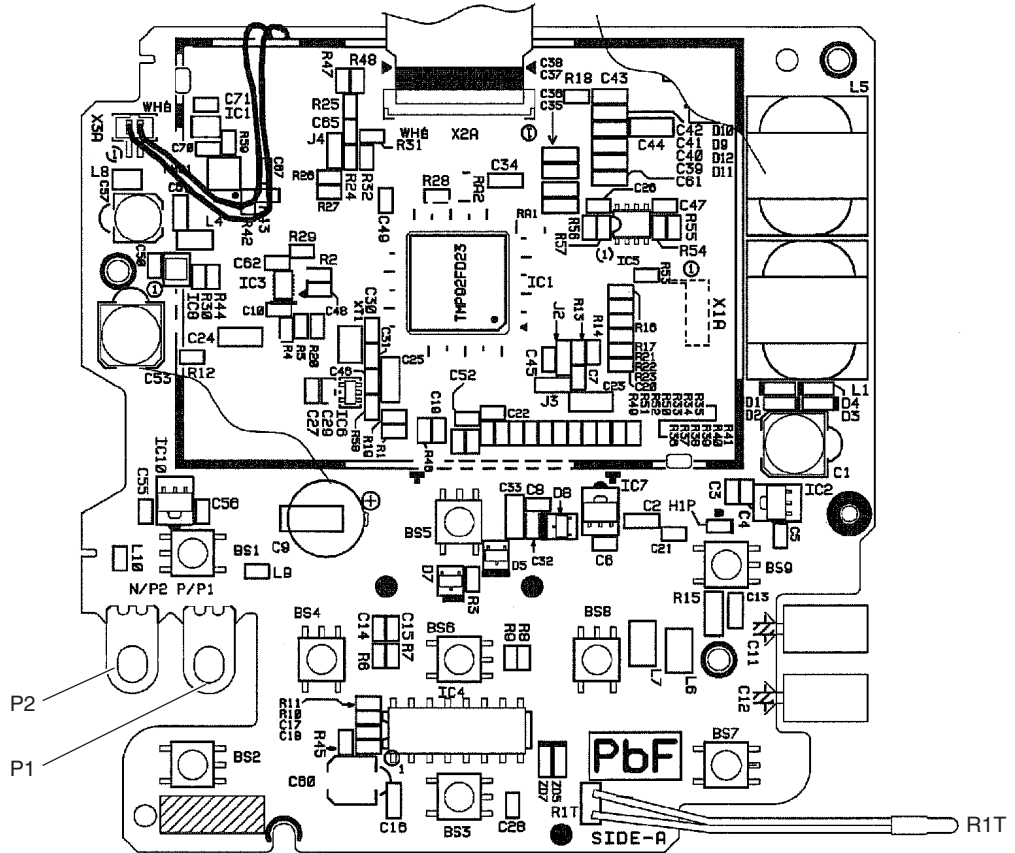

2P243326-3

3. Wireless Remote Controller

3.1 BRC7E830

Signal Receiver PCB

- 1) X1A Connector for display PCB
- 2) X2A Connector for control PCB
- 3) SS1 MAIN / SUB setting switch
* Refer to page 196 for detail.
- 4) SS2 Address setting switch
* Refer to page 196 for detail.

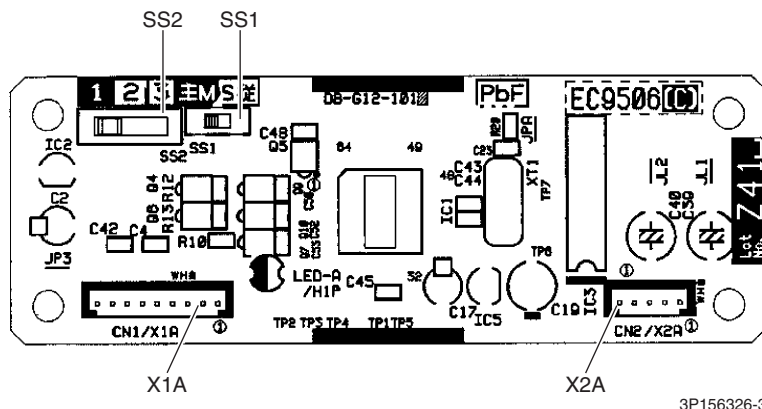

3P156326-3

Display PCB

- 1) X1A Connector for signal receiver PCB
- 2) BS1 Forced cooling operation **ON/OFF** button
- 3) LED1 (H1P) LED for operation (red)
- 4) LED2 (H2P) LED for timer (green)
- 5) LED3 (H3P) LED for filter cleaning sign (red)
- 6) LED4 (H4P) LED for defrost operation (orange)

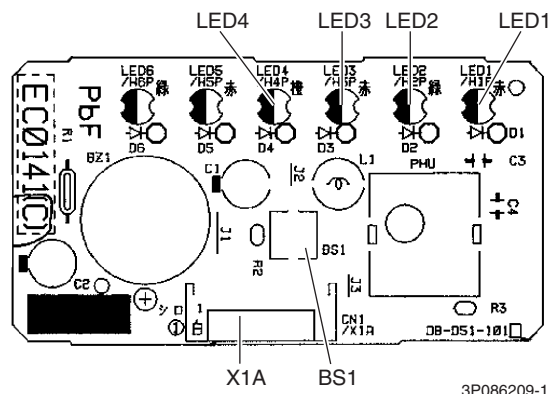

3P086209-1

★ LED5 and LED6 do not function.

4. Outdoor Unit

Main PCB (PCB1)

1) S	Connector for terminal board (indoor - outdoor transmission)
2) S15	Connector for COOL / HEAT mode lock * Refer to page 186 for detail.
3) S20 (white)	Connector for electronic expansion valve coil A port
4) S21 (red)	Connector for electronic expansion valve coil B port
5) S22 (blue)	Connector for electronic expansion valve coil C port (24/36 class)
6) S23 (yellow)	Connector for electronic expansion valve coil D port (36 class)
7) S40	Connector for overload protector
8) S70	Connector for DC fan motor
9) S80	Connector for four way valve coil
10) S90	Connector for thermistors (outdoor temperature, outdoor heat exchanger, discharge pipe)
11) S92	Connector for gas pipe thermistor
12) S93	Connector for liquid pipe thermistor
13) S201, S202	Connector for service monitor PCB
14) HL1, HN1	Connector for terminal board (power supply)
15) E1, E2	Connector for ground wire
16) U, V, W	Connector for compressor
17) FU1, FU2	Fuse (3.15 A, 250 V)
18) FU3	Fuse (30 A, 250 V)
19) V2, V3, V401	Varistor

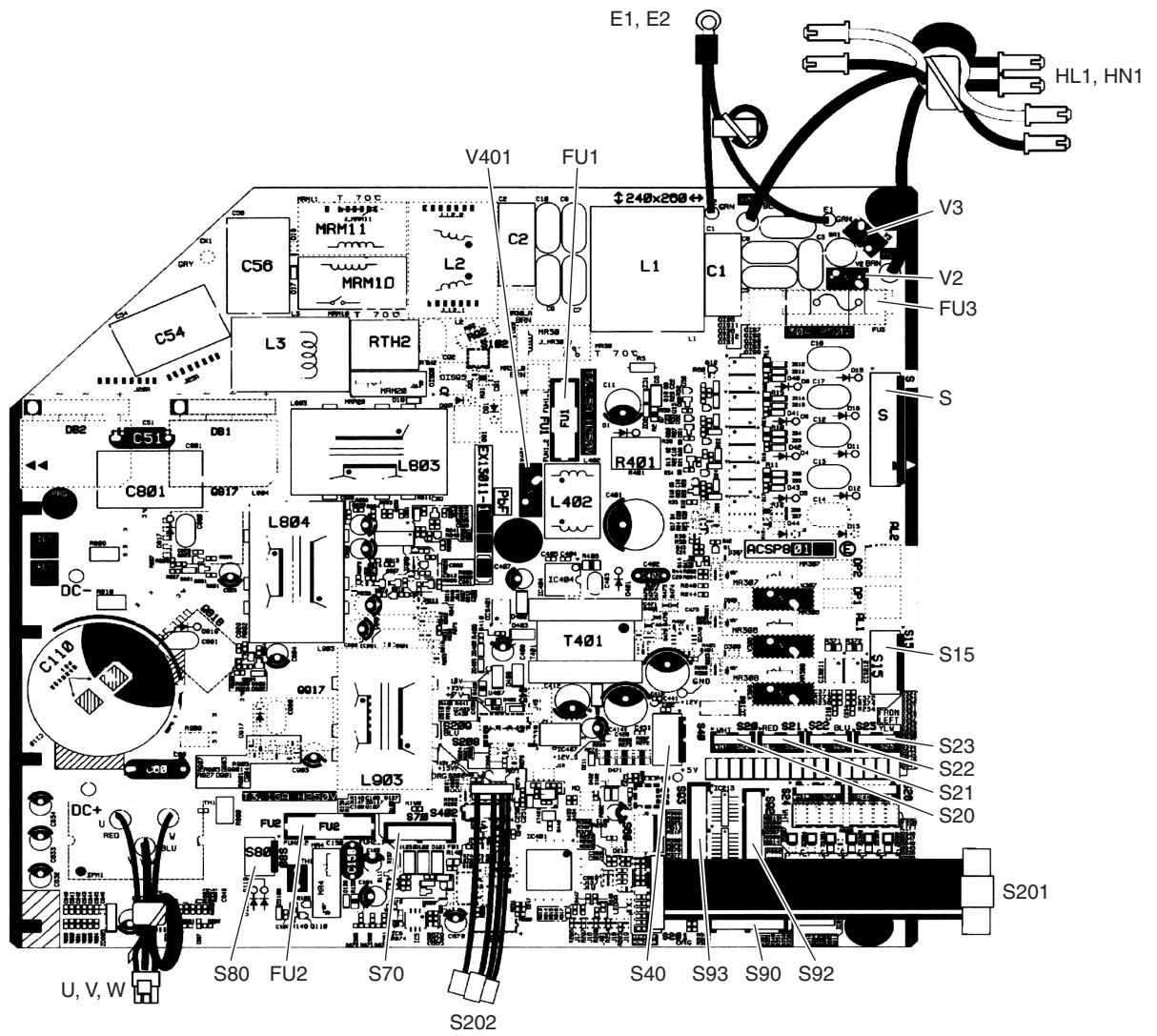

2P350358-10
2P350358-11

Service Monitor PCB (PCB2)

- | | |
|----------------|---|
| 1) S501, S502 | Connector for main PCB |
| 2) LED A | LED for service monitor (green) |
| 3) LED1 - LED5 | LED for service monitor (red) |
| 4) SW1 | Forced cooling operation ON/OFF switch
* Refer to page 178 for detail. |
| 5) SW2 | Operation mode switch
* Refer to page 178 for detail. |
| 6) SW3 | Wiring error check switch
* Refer to page 179 for detail. |
| 7) SW4 | Priority room setting switch
* Refer to page 185 for detail. |
| 8) SW6-1 | NIGHT QUIET mode setting switch
* Refer to page 186 for detail. |

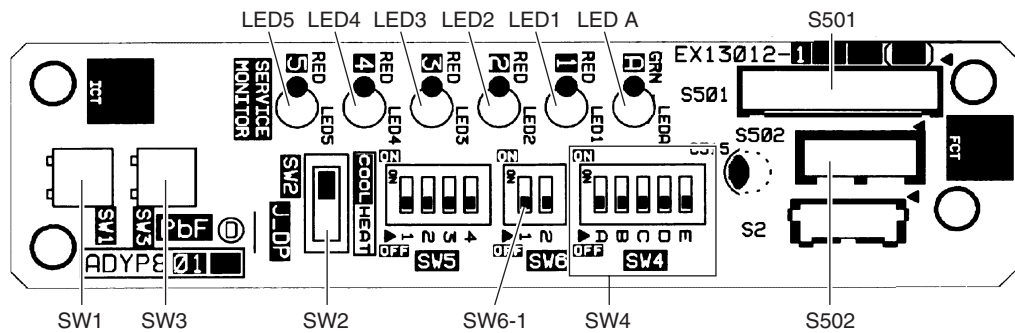

3P346711-10

★ SW6-2 and all the switches of SW5 have no function. Keep them OFF.

Part 4

Function and Control

1. Function of CTXS, FTXS, CDXS, FDXS, FVXS Series	34
1.1 Temperature Control	34
1.2 Frequency Principle.....	34
1.3 Airflow Direction Control (CTXS, FTXS, FVXS Series)	36
1.4 Fan Speed Control for Indoor Unit	39
1.5 Program Dry Operation	40
1.6 Automatic Operation.....	41
1.7 Thermostat Control.....	42
1.8 NIGHT SET Mode	43
1.9 ECONO Operation	43
1.10 INTELLIGENT EYE Operation (CTXS, FTXS Series).....	44
1.11 Inverter POWERFUL Operation	45
1.12 Clock Setting	46
1.13 WEEKLY TIMER Operation (CTXS, FTXS, FVXS series)	47
1.14 Other Functions.....	53
2. Function of FFQ Series	54
2.1 Drain Pump Control.....	54
2.2 Thermostat Sensor in Remote Controller	56
2.3 Freeze Prevention Control	58
2.4 Hot Start Control (In Heating Operation Only).....	59
3. Control Specification	60
3.1 Function of Thermistor	60
3.2 Mode Hierarchy	62
3.3 Frequency Control.....	63
3.4 Controls at Mode Changing / Start-up.....	65
3.5 Discharge Pipe Temperature Control.....	66
3.6 Input Current Control.....	67
3.7 Freeze-up Protection Control	68
3.8 Heating Peak-cut Control	68
3.9 Outdoor Fan Control.....	69
3.10 Liquid Compression Protection Function.....	69
3.11 Defrost Control	70
3.12 Low Hz High Pressure Limit	71
3.13 Electronic Expansion Valve Control	72
3.14 Malfunctions	77

1. Function of CTXS, FTXS, CDXS, FDXS, FVXS Series

1.1 Temperature Control

Definitions of Temperatures

The definitions of temperatures are classified as following.

- ◆ Room temperature: temperature of lower part of the room
- ◆ Set temperature: temperature set by remote controller
- ◆ Room thermistor temperature: temperature detected by room temperature thermistor
- ◆ Target temperature: temperature determined by microcomputer

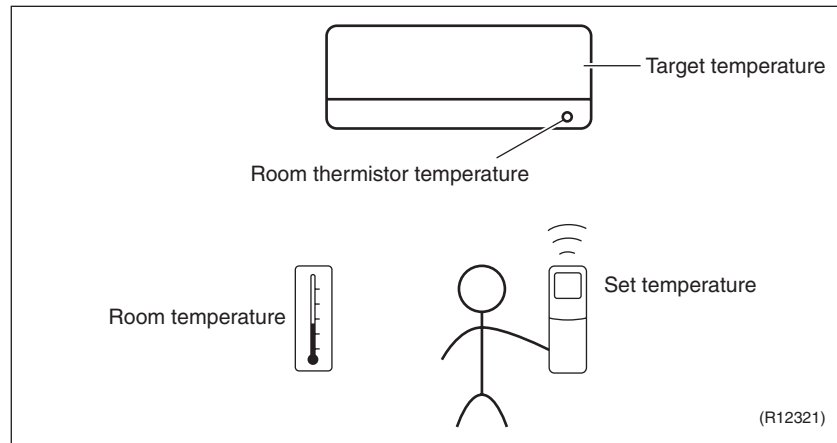

★ The illustration is for CTXS, FTXS series as representative.

Temperature Control

The temperature of the room is detected by the room temperature thermistor. However, there is difference between the temperature detected by room temperature thermistor and the temperature of lower part of the room, depending on the type of the indoor unit or installation condition. Practically, the temperature control is done by the target temperature appropriately adjusted for the indoor unit and the temperature detected by room temperature thermistor.

1.2 Frequency Principle

Control Parameters

The frequency of the compressor is controlled by the following 2 parameters:

- The load condition of the operating indoor unit
- The difference between the room thermistor temperature and the target temperature

The target frequency is adapted by additional parameters in the following cases:

- Frequency restrictions
- Initial settings
- Forced cooling operation

Inverter Principle

To regulate the capacity, a frequency control is needed. The inverter makes it possible to control the rotation speed of the compressor. The following table explains the inverter principle:

Phase	Description
1	The supplied AC power source is converted into the DC power source for the present.
2	The DC power source is reconverted into the three phase AC power source with variable frequency. <ul style="list-style-type: none"> ■ When the frequency increases, the rotation speed of the compressor increases resulting in an increase of refrigerant circulation. This leads to a larger amount of heat exchange per unit. ■ When the frequency decreases, the rotation speed of the compressor decreases resulting in a decrease of refrigerant circulation. This leads to a smaller amount of heat exchange per unit.

The following drawing shows a schematic view of the inverter principle:

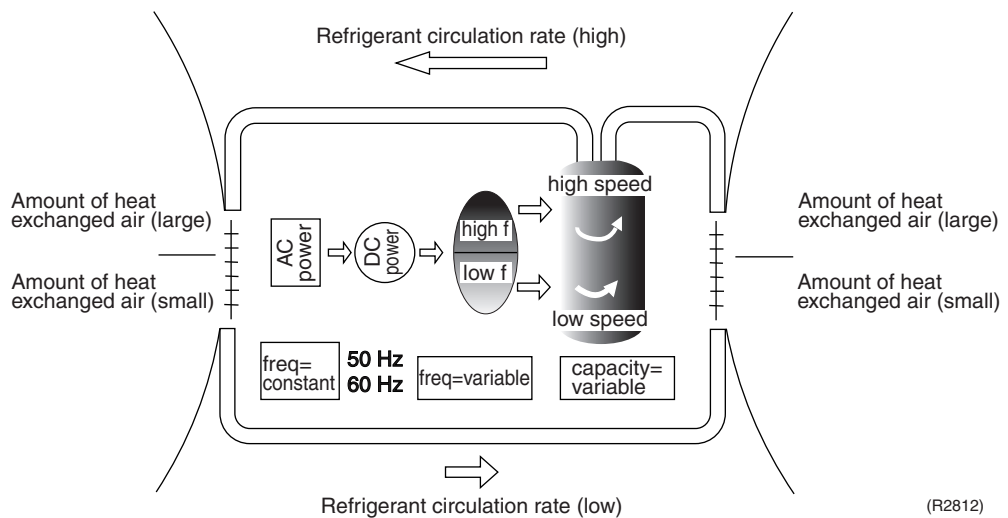

Inverter Features

The inverter provides the following features:

- The regulating capacity can be changed according to the changes in the outdoor temperature and cooling / heating load.
- Quick heating and quick cooling
The rotation speed of the compressor is increased when starting the heating (or cooling). This enables to reach the set temperature quickly.
- Even during extreme cold weather, high capacity is achieved. It is maintained even when the outdoor temperature is 2°C (35.6°F).
- Comfortable air conditioning
A fine adjustment is integrated to keep the room temperature constant.
- Energy saving heating and cooling
Once the set temperature is reached, the energy saving operation enables to maintain the room temperature at low power.

Frequency Limits

The following functions regulate the minimum and maximum frequency:

Frequency	Functions
Low	<ul style="list-style-type: none"> ■ Four way valve operation compensation. Refer to page 65.
High	<ul style="list-style-type: none"> ■ Compressor protection function. Refer to page 66. ■ Discharge pipe temperature control. Refer to page 66. ■ Input current control. Refer to page 67. ■ Freeze-up protection control. Refer to page 68. ■ Heating peak-cut control. Refer to page 68. ■ Defrost control. Refer to page 70.

Forced Cooling Operation

Refer to page 178 for detail.

1.3 Airflow Direction Control (CTXS, FTXS, FVXS Series)

Power-Airflow Dual Flaps

The large flap sends a large volume of air downward to the floor and provides an optimum control in cooling, dry, and heating operation.

<Cooling / Dry>

During cooling or dry operation, the flap retracts into the indoor unit. Then, cool air can be blown far and distributed all over the room.

<Heating>

During heating operation, the large flap directs airflow downward to spread the warm air to the entire room.

Wide-Angle Louvers

The louvers, made of elastic synthetic resin, provide a wide range of airflow that guarantees a comfortable air distribution.

Auto-Swing

The following table explains the auto swing process for cooling, dry, heating, and fan:

CTXS, FTXS Series

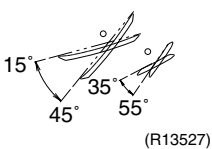
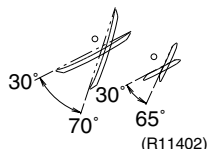
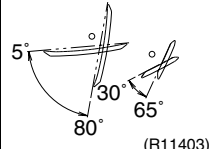
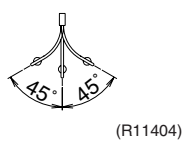
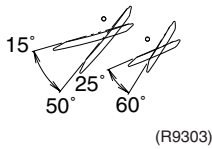
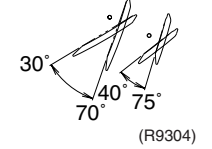
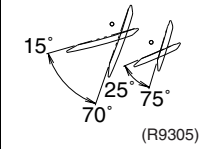
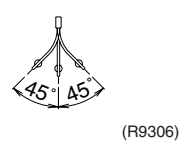
	Flap (up and down)			Louver (right and left)
	Cooling / Dry	Heating	Fan	
07/09/12 class				
15/18/24 class				

FVXS Series

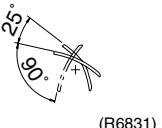
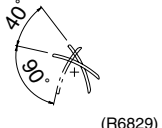
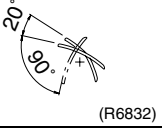
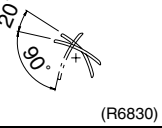
	Flap (up and down)	
	Cooling / Dry	Heating
Upward airflow limit OFF	 (R6831)	 (R6829)
Upward airflow limit ON	 (R6832)	 (R6830)

3-D Airflow

CTXS, FTXS Series

Alternative repetition of vertical and horizontal swing motions enables uniform air-conditioning of the entire room.

When the horizontal swing and vertical swing are both set to automatic operation, the airflow becomes 3-D airflow. The horizontal and vertical swing motions are alternated and the airflow direction changes in the order shown in the following diagram.

- (1) The louvers move from the right to the left.
- (2) The flaps move downward.
- (3) The louvers move from the left to the right.
- (4) The flaps move upward.

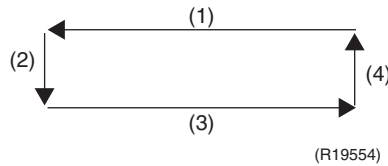

COMFORT AIRFLOW Operation

CTXS, FTXS Series

The flaps are controlled not to blow the air directly at the people in the room.

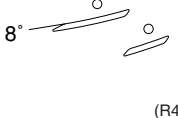
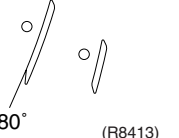
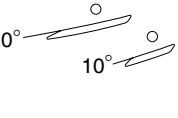
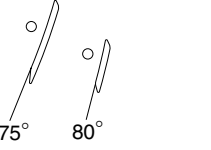
	Cooling	Heating
07/09/12 class	 (R4302)	 (R8413)
15/18/24 class	 (R9655)	 (R9654)

Airflow Selection Setting

FVXS Series

Airflow direction can be set with the airflow selection switch.

- Open the front panel.

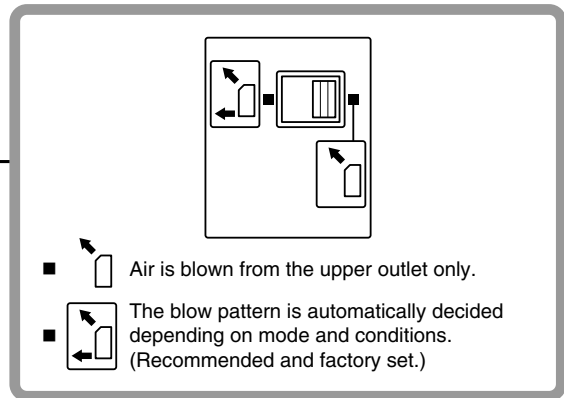
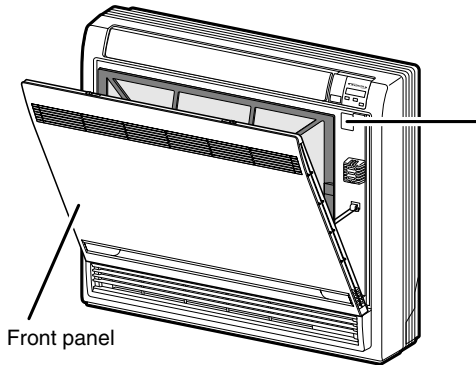

(R17866)



Caution:

Before opening the front panel, be sure to stop the operation and turn the breaker off. Do not touch the aluminum fins (indoor heat exchanger) inside of the indoor unit, as it may result in injury.

When setting the airflow selection switch to

- The air conditioner automatically decides the appropriate blowing pattern depending on the operating mode / situation.

Operating mode	Situation	Blowing pattern
Cooling operation	When the room has become fully cool, or when 1 hour has passed since turning on the air conditioner.	Air is blown from the upper air outlet, so that air does not come into direct contact with people, and room temperature is equalized.
	At the start of operation or when the room is not fully cooled.	<p>(R17867)</p> <p>Air is blown from the upper and lower air outlets for high speed cooling during cooling operation, and for filling the room with warm air during heating operation.</p>
Heating operation	Normal time	
	At the start or when air temperature is low.	Air is blown from the upper air outlet, so that air does not come into direct contact with people.

- During dry operation, air is blown upper air outlet, so that cold air does not come into direct contact with people.

When setting the airflow selection switch to

- Regardless of the operating mode or situation, air is blown from the upper air outlet.
- Use this switch when you do not want air coming out of the lower air outlet (e.g., while sleeping).



1.4 Fan Speed Control for Indoor Unit

Outline

Phase control and fan speed control contains 9 steps: LLL, LL, SL, L, ML, M, MH, H, and HH. The airflow rate can be automatically controlled depending on the difference between the room thermistor temperature and the target temperature.

Automatic Fan Speed Control

In automatic fan speed control, the step SL is not available.

Step	Cooling	Heating
LLL	 (R11681)	 (R6834)
LL		
L		
ML		
M		
MH		
H		
HH (POWERFUL)		

 = The airflow rate is automatically controlled within this range when the **FAN** button is set to automatic.

<Cooling>

The following drawing explains the principle of fan speed control for cooling.

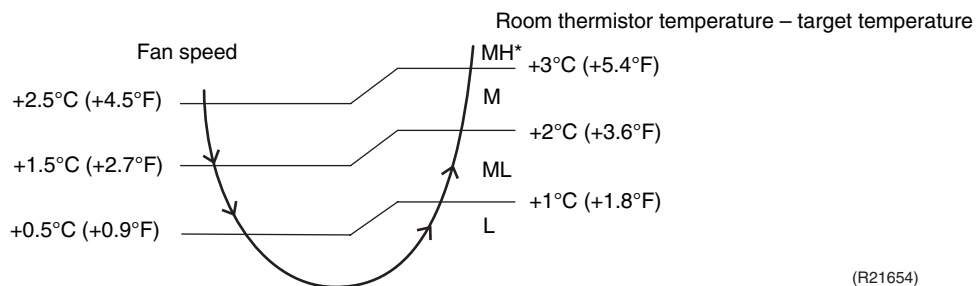

*The upper limit is M tap in 30 minutes from the operation start.

<Heating>

In heating operation, the fan speed is regulated according to the indoor heat exchanger temperature and the difference between the room thermistor temperature and the target temperature.



Note: The fan stops during defrost operation.

COMFORT AIRFLOW Operation

CTXS, FTXS Series

- The fan speed is controlled automatically within the following steps.

<Cooling>

L tap ~ MH tap (same as AUTOMATIC)

<Heating>

ML tap ~ MH tap

- The latest command has the priority between POWERFUL and COMFORT AIRFLOW.

1.5 Program Dry Operation

Outline Program dry operation removes humidity while preventing the room temperature from lowering. Since the microcomputer controls both the temperature and airflow rate, the temperature adjustment and **FAN** setting buttons are inoperable.

Detail The microcomputer automatically sets the temperature and airflow rate. The difference between the room thermistor temperature at start-up and the target temperature is divided into two zones. Then, the unit operates in an appropriate capacity for each zone to maintain the temperature and humidity at a comfortable level.

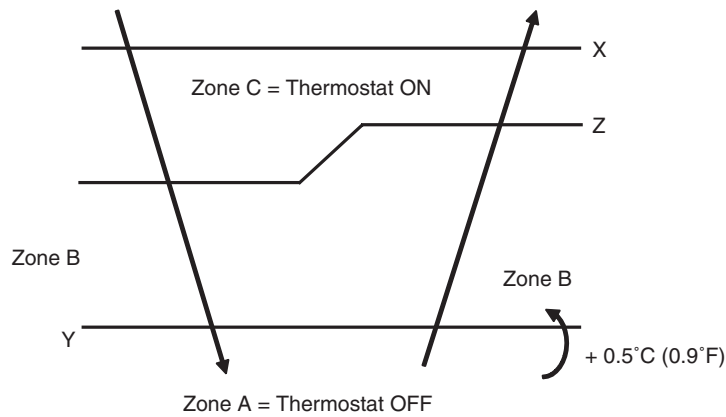

(R11587)

Room thermistor temperature at start-up	Target temperature X	Thermostat OFF point Y	Thermostat ON point Z ★
24°C or more (75.2°F or more)	Room thermistor temperature at start-up	X - 2.5°C (X - 4.5°F)	X - 0.5°C (X - 0.9°F)
18 ~ 23.5°C (64.4 ~ 74.3°F)		X - 2.0°C (X - 3.6°F)	X - 0.5°C (X - 0.9°F)
17.5°C or less (63.5°F or less)	18°C (64.4°F)	X - 2.0°C (X - 3.6°F)	X - 0.5°C = 17.5°C (X - 0.9°F = 63.5°F)

★ Thermostat turns on also when the room temperature is in the zone B for 10 minutes.

1.6 Automatic Operation

Outline

Automatic Cooling / Heating Function

When the automatic operation is selected with the remote controller, the microcomputer automatically determines the operation mode as cooling or heating according to the room temperature and the set temperature at start-up.

The unit automatically switches the operation mode to maintain the room temperature at the set temperature.

Detail

Ts: set temperature (set by remote controller)
 Tt: target temperature (determined by microcomputer)
 Tr: room thermistor temperature (detected by room temperature thermistor)
 C: correction value

- The set temperature (Ts) determines the target temperature (Tt).
 (Ts = 18 ~ 30°C, 64.4 ~ 86°F).
- The target temperature (Tt) is calculated as;
 $Tt = Ts + C$
 where C is the correction value.
 C = 0°C (0°F)
- Thermostat ON/OFF point and operation mode switching point are as follows.
 - Heating → Cooling switching point:
 $Tr \geq Tt + 3.0^\circ\text{C}$ (+5.4°F) (CTXS, FTXS series)
 $Tr \geq Tt + 2.5^\circ\text{C}$ (+4.5°F) (CDXS, FDXS, FVXS series)
 - Cooling → Heating switching point:
 $Tr < Tt - 3.0^\circ\text{C}$ (-5.4°F)
 - Thermostat ON/OFF point is the same as the ON/OFF point of cooling or heating operation.
- During initial operation
 $Tr \geq Ts$: Cooling operation
 $Tr < Ts$: Heating operation

CTXS, FTXS series

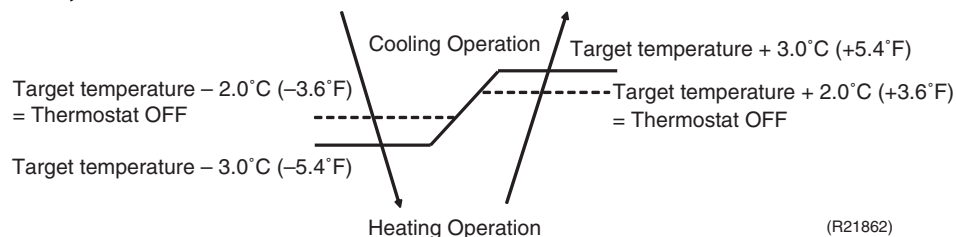

Ex: When the target temperature is 25°C (77°F)

Cooling → 23°C (73.4°F): Thermostat OFF → 22°C (71.6°F): Switch to heating

Heating → 27°C (80.6°F): Thermostat OFF → 28°C (82.4°F): Switch to cooling

CDXS, FDXS, FVXS series

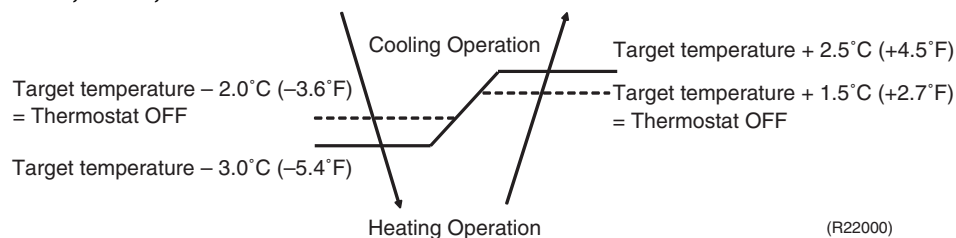

Ex: When the target temperature is 25°C (77°F)

Cooling → 23°C (73.4°F): Thermostat OFF → 22°C (71.6°F): Switch to heating

Heating → 26.5°C (79.7°F): Thermostat OFF → 27.5°C (81.5°F): Switch to cooling

1.7 Thermostat Control

Outline

Thermostat control is based on the difference between the room thermistor temperature and the target temperature.

Detail

Thermostat OFF Condition

- ♦ The temperature difference is in the zone A.

Thermostat ON Condition

- ♦ The temperature difference returns to the zone C after being in the zone A.
- ♦ The system resumes from defrost control in any zones except A.
- ♦ The operation turns on in any zones except A.
- ♦ The monitoring time has passed while the temperature difference is in the zone B.
(Cooling / Dry: 10 minutes, Heating: 10 seconds)

<Cooling / Dry>

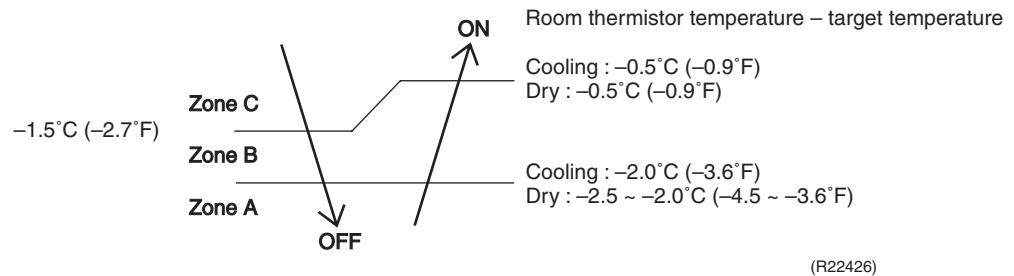

<Heating>

CTXS, FTXS series

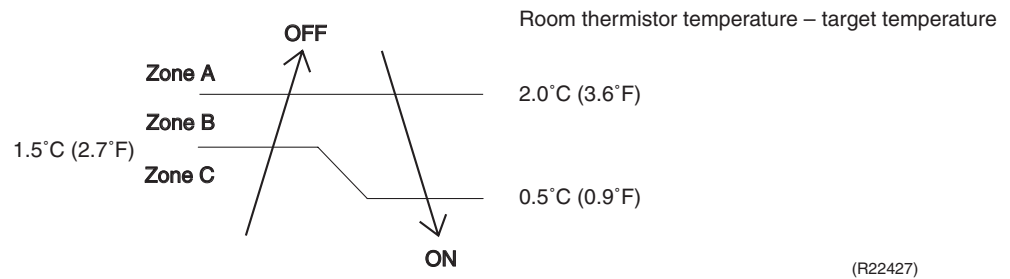

CDXS, FDXS, FVXS series

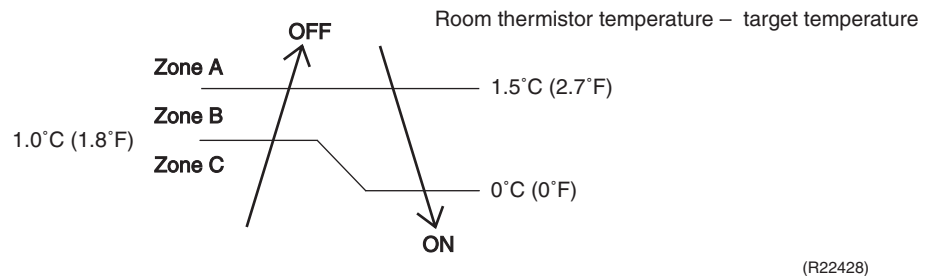

Refer to Temperature Control on page 34 for detail.

1.8 NIGHT SET Mode

Outline When the OFF TIMER is set, NIGHT SET Mode is automatically activated. NIGHT SET Mode keeps the airflow rate setting.

Detail NIGHT SET Mode continues operation at the target temperature for the first one hour, then automatically raises the target temperature slightly in cooling, or lowers it slightly in heating. This prevents excessive cooling or heating to ensure comfortable sleeping conditions, and also conserves electricity.

<Cooling>

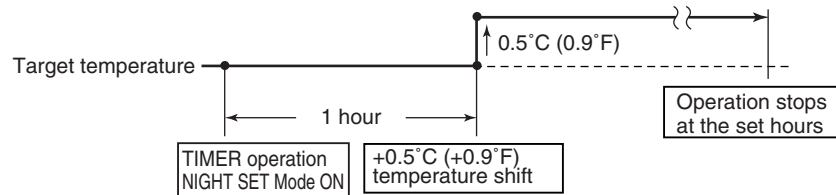

(R21924)

<Heating>

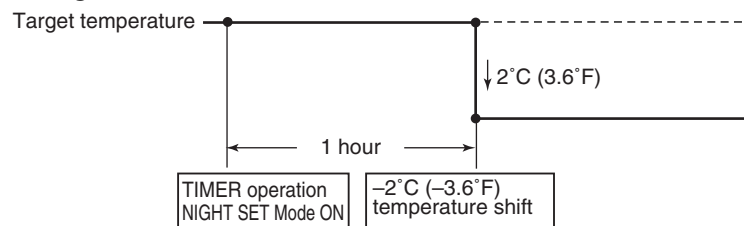

(R21925)

1.9 ECONO Operation

Outline ECONO operation reduces the maximum operating current and the power consumption. This operation is particularly convenient for energy-saving. It is also a major bonus when breaker capacity does not allow the use of multiple electrical devices and air conditioners. It can be easily activated by pushing the **ECONO** button on the wireless remote controller.

- Detail**
- When this function is activated, the maximum capacity also decreases.
 - The remote controller can send the ECONO command when the unit is in cooling, heating, dry, or automatic operation. This function can only be set when the unit is running. Press the **ON/OFF** button on the remote controller to cancel the function.
 - This function and POWERFUL operation cannot be used at the same time. The latest command has the priority.

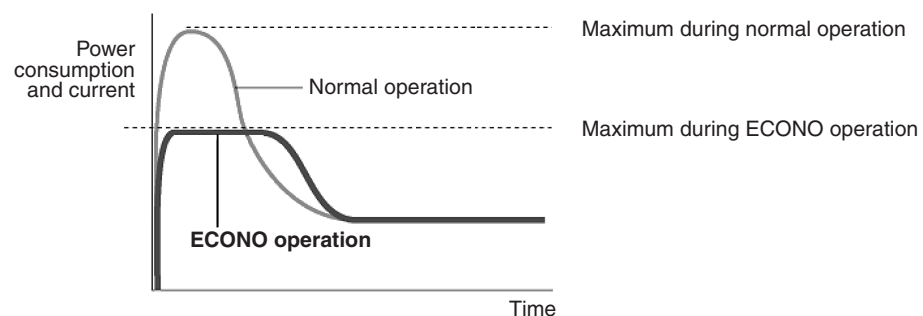

(R22012)

1.10 INTELLIGENT EYE Operation (CTXS, FTXS Series)

Outline

This function detects the existence of humans in the room with a motion sensor (INTELLIGENT EYE) and reduces the capacity when there is nobody in the room in order to save electricity.

Detail

1. Detection method by INTELLIGENT EYE

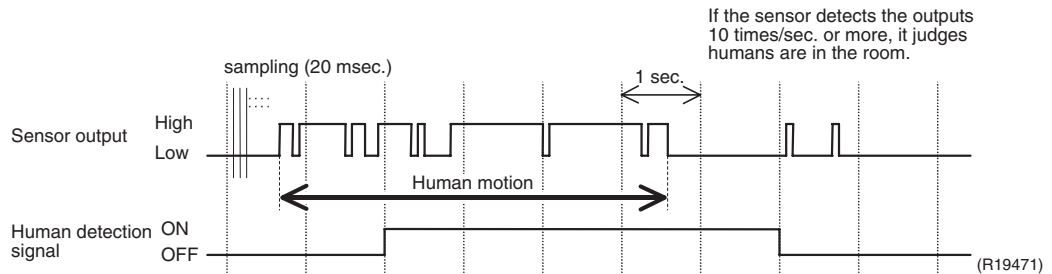

- The sensor detects human motion by receiving infrared rays and displays the pulse wave output.
- The microcomputer in the indoor unit carries out a sampling every 20 msec. and if it detects 10 cycles of the wave in 1 second in total, it judges humans are in the room as the motion signal is ON.
- The sensor may detect human motion with up to 20 msec. latency.

2. The motions (in cooling)

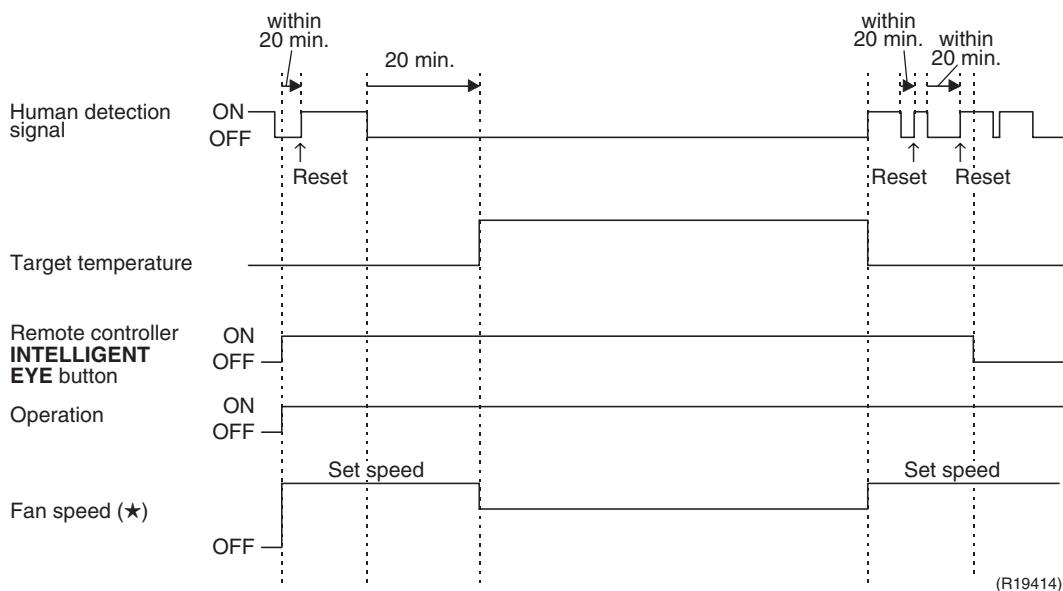

★ In FAN operation, the fan speed is reduced by 60 rpm.

- When the microcomputer does not have a signal from the sensor in 20 minutes, it judges that nobody is in the room and operates the unit at a temperature shifted from the target temperature. (Cooling / Dry: 1 ~ 2°C (1.8 ~ 3.6°F) higher, Heating: 2°C (3.6°F) lower, Auto: according to the operation mode at that time.)



Note: For dry operation, the temperature cannot be set with a remote controller, but the target temperature is shifted internally.

1.11 Inverter POWERFUL Operation

Outline

In order to exploit the cooling and heating capacity to full extent, the air conditioner can be operated by increasing the indoor fan rotating speed and the compressor frequency.

Detail

When **POWERFUL** button is pressed, the fan speed and target temperature are converted to the following states for 20 minutes.

Operation mode	Fan speed	Target temperature
COOL	H tap + A rpm	18°C (64.4°F)
DRY	Dry rotating speed + A rpm	Lowered by 2 ~ 2.5°C (3.6 ~ 4.5°F)
HEAT	H tap + A rpm	30 ~ 31.5°C (86 ~ 88.7°F)
FAN	H tap + A rpm	—
AUTO	Same as cooling / heating in POWERFUL operation	The target temperature is kept unchanged.

A = 50 ~ 90 rpm (depending on the model)

Ex: POWERFUL operation in cooling

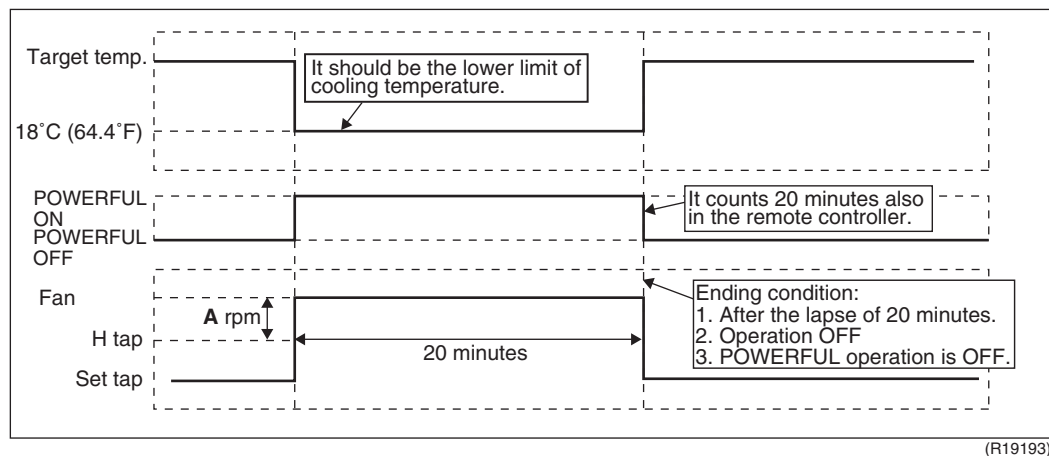

Note: POWERFUL operation cannot be used together with ECONO or COMFORT AIRFLOW operation.

1.12 Clock Setting

ARC452 Series ARC466 Series

The clock can be set by taking the following steps:

1. Press the **CLOCK** button.
→ 0:00 is displayed and MON and ☉ blink.
2. Press the **SELECT ▲** or **SELECT ▼** button to set the clock to the current day of the week.
3. Press the **CLOCK** button.
→ ☉ blinks.
4. Press the **SELECT ▲** or **SELECT ▼** button to adjust the clock to the present time.
Holding down the **SELECT ▲** or **SELECT ▼** button increases or decreases the time display rapidly.
5. Press the **CLOCK** button to set the clock. (Point the remote controller at the indoor unit when pressing the button.)
→ : blinks and clock setting is completed.

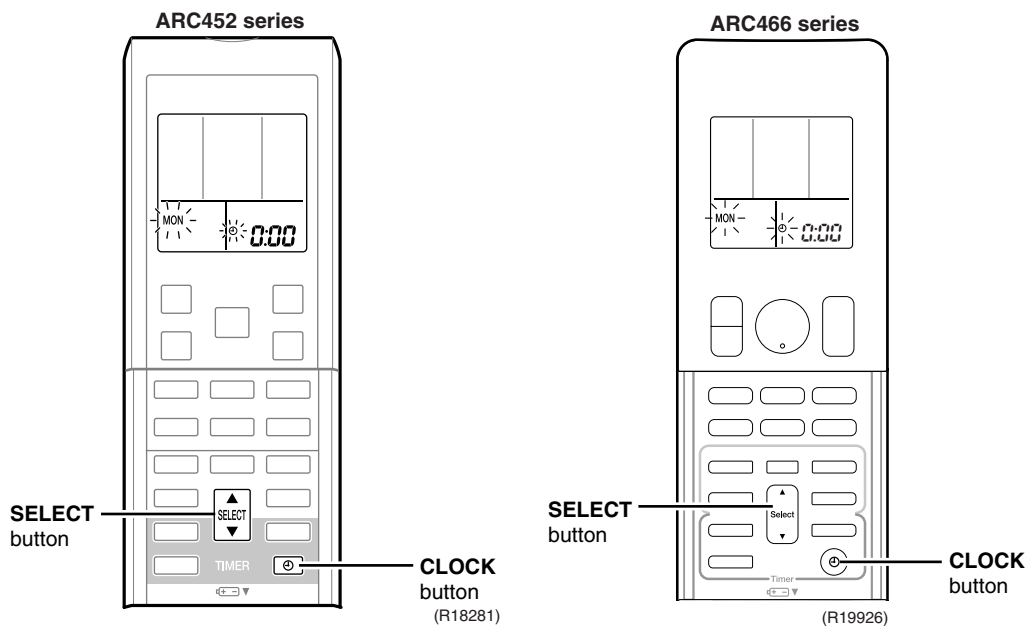

1.13 WEEKLY TIMER Operation (CTXS, FTXS, FVXS series)

Outline

Up to 4 timer settings can be saved for each day of the week (up to 28 settings in total).
The 3 items: ON/OFF, temperature, and time can be set.

Detail

★ The illustrations are for FVXS series as representative.

Setting example of the WEEKLY TIMER

The same timer settings are used from Monday through Friday, while different timer settings are used for the weekend.

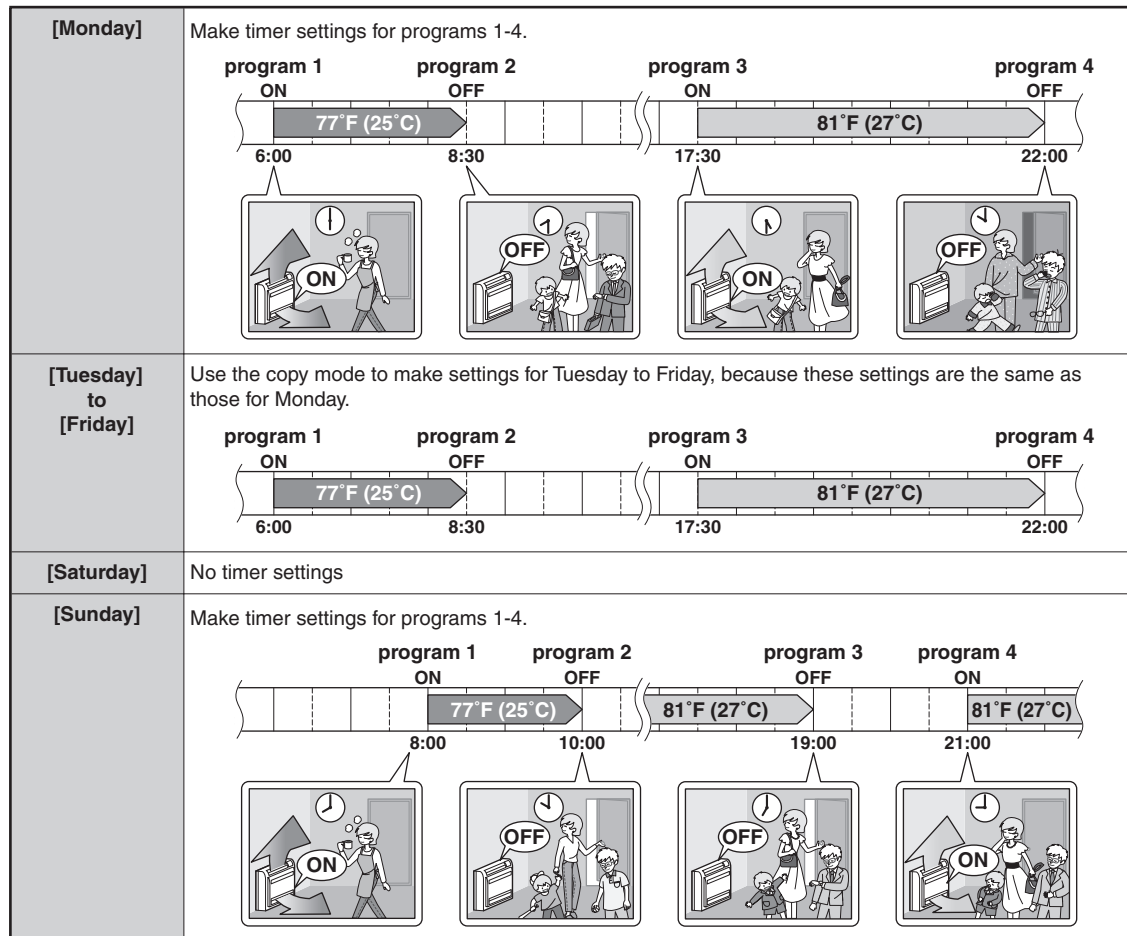

- Up to 4 reservations per day and 28 reservations per week can be set using the WEEKLY TIMER. The effective use of the copy mode simplifies timer programming.
- The use of ON-ON-ON-ON settings, for example, makes it possible to schedule operating mode and set temperature changes. Furthermore, by using OFF-OFF-OFF-OFF settings, only the turn off time of each day can be set. This will turn off the air conditioner automatically if you forget to turn it off.

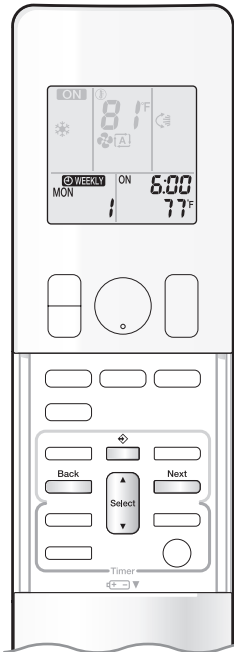

To use WEEKLY TIMER operation

Setting mode

- Make sure the day of the week and time are set.
If not, set the day of the week and time.

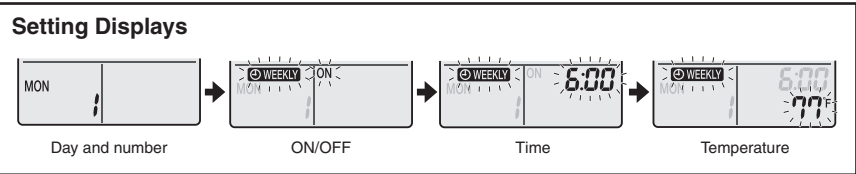
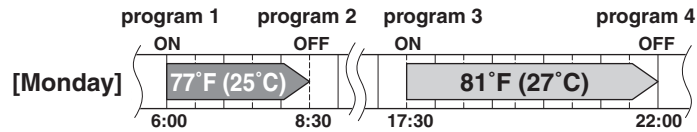

1. Press .

- The day of the week and the reservation number of the current day will be displayed.
- 1 to 4 settings can be made per day.

2. Press to select the desired day of the week and reservation number.

- Pressing changes the reservation number and the day of the week.

3. Press .

- The day of the week and reservation number will be set.
- “ WEEKLY ” and “ON” blink.

4. Press to select the desired mode.

- Pressing changes the “ON” or “OFF” setting in sequence.



- In case the reservation has already been set, selecting “ blank ” deletes the reservation.
- Proceed to **STEP 9** if “ blank ” is selected.
- To return to the day of the week and reservation number setting, press .

5. Press .

- The ON/OFF TIMER mode will be set.
- “ WEEKLY ” and the time blink.

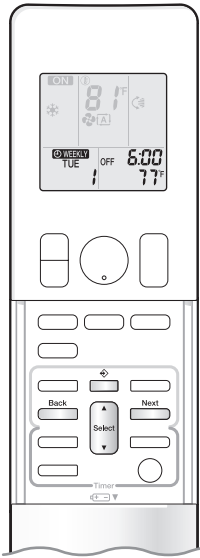

6. Press  to select the desired time.

- The time can be set between 0:00 and 23:50 in 10-minute intervals.
- To return to the ON/OFF TIMER mode setting, press .
- Proceed to **STEP 9** when setting the OFF TIMER.

7. Press .

- The time will be set.
- “ WEEKLY” and the temperature blink.

8. Press  to select the desired temperature.

- The temperature can be set between 50°F (10°C) and 90°F (32°C).
COOL or AUTO: The unit operates at 64°F (18°C) even if it is set at 50°F (10°C) to 63°F (17°C).
HEAT or AUTO : The unit operates at 86°F (30°C) even if it is set at 87°F (31°C) to 90°F (32°C).
- To return to the time setting, press .
- The set temperature is only displayed when the mode setting is on.

9. Press .

- The temperature will be set and go to the next reservation setting.
- The temperature is set while in ON TIMER operation, and the time is set while in OFF TIMER operation.
- The next reservation screen will appear.
- To continue further settings, repeat the procedure from **STEP 4**.

10. Press  to complete the setting.

- Be sure to direct the remote controller toward the indoor unit and check for a receiving tone and blinking of the OPERATION lamp.
- “ WEEKLY” is displayed on the LCD and WEEKLY TIMER operation is activated.
- The TIMER lamp lights orange.

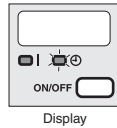



Display

- A reservation made once can be easily copied and the same settings used for another day of the week. Refer to **Copy mode**.

NOTE

Notes on WEEKLY TIMER operation

- Do not forget to set the clock on the remote controller first.
- The day of the week, ON/OFF TIMER mode, time and set temperature (only for ON TIMER mode) can be set with the WEEKLY TIMER. Other settings for the ON TIMER are based on the settings just before the operation.
- WEEKLY TIMER and ON/OFF TIMER operation cannot be used at the same time. The ON/OFF TIMER operation has priority if it is set while WEEKLY TIMER is still active. The WEEKLY TIMER will enter the standby state, and “ WEEKLY” will disappear from the LCD. When the ON/OFF TIMER is up, the WEEKLY TIMER will automatically become active.
- Only the time and set temperature with the WEEKLY TIMER are sent with the . Set the WEEKLY TIMER only after setting the operation mode, the airflow rate and the airflow direction ahead of time.
- Turning off the circuit breaker, power failure, and other similar events will render operation of the indoor unit’s internal clock inaccurate. Reset the clock.
-  can be used only for the time and temperature settings. It cannot be used to go back to the reservation number.

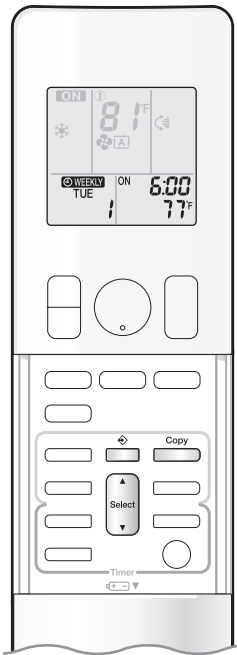





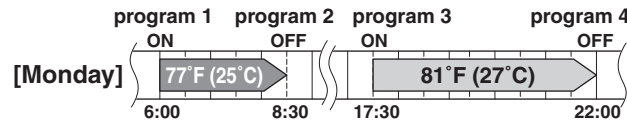

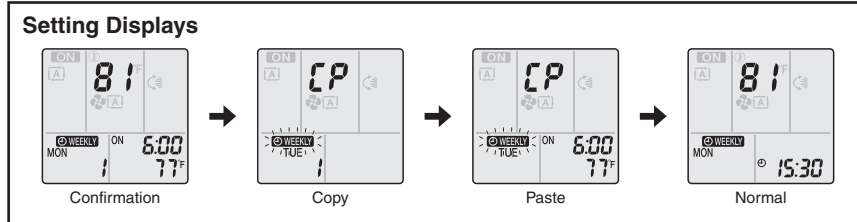
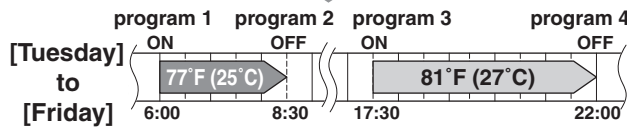

Copy mode

- A reservation made once can be copied to another day of the week. The whole reservation of the selected day of the week will be copied.



COPY



1. Press .
2. Press  to confirm the day of the week to be copied.
3. Press .
 - The whole reservation of the selected day of the week will be copied.
4. Press  to select the destination day of the week.
5. Press .
 - The reservation will be copied to the selected day of the week. The whole reservation of the selected day of the week will be copied.
 - To continue copying the settings to other days of the week, repeat **STEP 4** and **STEP 5**.
6. Press  to complete the setting.
 - “ WEEKLY” is displayed on the LCD and WEEKLY TIMER operation is activated.

NOTE

Note on COPY MODE

- The entire reservation of the source day of the week is copied in the copy mode.
- In the case of making a reservation change for any day of the week individually after copying the content of weekly reservations, press  and change the settings in the steps of **Setting mode**.

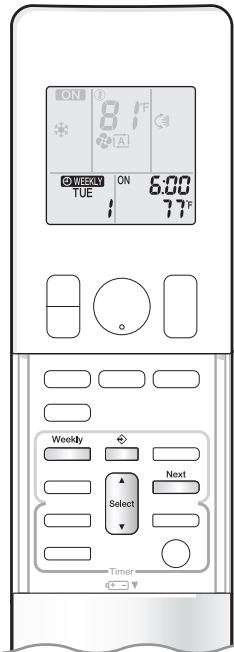

Confirming a reservation

- The reservation can be confirmed.

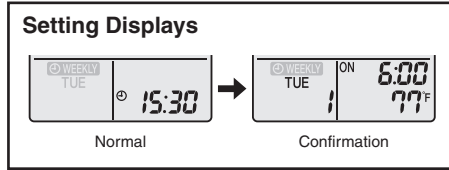

1. Press .

- The day of the week and the reservation number of the current day will be displayed.

2. Press **to select the day of the week and the reservation number to be confirmed.**

- Pressing displays the reservation details.
- To change the confirmed reserved settings, select the reservation number and press . The mode is switched to setting mode. Proceed to **Setting mode STEP 4.**

3. Press **to exit the confirmation mode.**

- “ WEEKLY” is displayed on the LCD and WEEKLY TIMER operation is activated.
- The TIMER lamp lights orange.

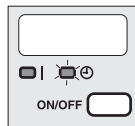

Display

To deactivate WEEKLY TIMER operation

Press **while “ WEEKLY” is displayed on the LCD.**

- “ WEEKLY” disappears from the LCD.
- The TIMER lamp goes off.
- To reactivate the WEEKLY TIMER operation, press again.
- If a reservation deactivated with is activated once again, the last reservation mode will be used.

NOTE

- If not all the reservation settings are reflected, deactivate the WEEKLY TIMER operation once. Then press again to reactivate the WEEKLY TIMER operation.

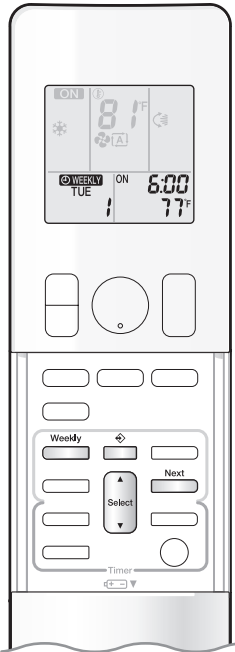

To delete reservations

An individual reservation

1. Press .

- The day of the week and the reservation number will be displayed.

2. Press to select the day of the week and the reservation number to be deleted.

3. Press .

- “ WEEKLY” and “ON” or “OFF” blink.

4. Press until no icon is displayed.

- Pressing  changes the ON/OFF TIMER mode in sequence.
- Selecting “blank” will cancel any reservation you may have.



Pressing  puts the sequence in reverse.

5. Press .

- The selected reservation will be deleted.

6. Press .

- If there are still other reservations, WEEKLY TIMER operation will be activated.

Reservations for each day of the week

- This function can be used for deleting reservations for each day of the week.
- It can be used while confirming or setting reservations.

1. Press .

- The day of the week and the reservation number will be displayed.

2. Press to select the day of the week to be deleted.

3. Hold for about 5 seconds.

- The reservation of the selected day of the week will be deleted.

4. Press .

- If there are still other reservations, WEEKLY TIMER operation will be activated.

All reservations

Hold for about 5 seconds with the normal display.

- Be sure to direct the remote controller toward the indoor unit and check for a receiving tone.
- This operation cannot be used for the WEEKLY TIMER setting display.
- All reservations will be deleted.

1.14 Other Functions

1.14.1 Hot-Start Function

In order to prevent the cold air blast that normally occurs when heating operation starts, the temperature of the indoor heat exchanger is detected, and the airflow is either stopped or significantly weakened resulting in comfortable heating.



Note: The cold air blast is prevented using similar control when defrost control starts or when the thermostat is turned ON.

1.14.2 Signal Receiving Sign

When the indoor unit receives a signal from the remote controller, the unit emits a signal receiving sound.

1.14.3 Indoor Unit ON/OFF Button

An **ON/OFF** button is provided on the display of the unit.

- Press the **ON/OFF** button once to start operation. Press once again to stop it.
- The **ON/OFF** button is useful when the remote controller is missing or the battery has run out.

Operation mode	Temperature setting	Airflow rate
AUTO	25°C (77°F)	Automatic

- In the case of multi system operation, there are times when the unit does not activate with this button.

Ex: CTXS, FTXS series

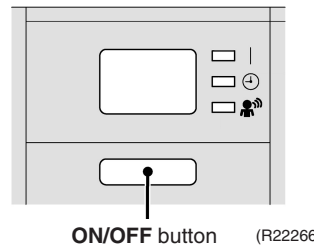

1.14.4 Auto-restart Function

If a power failure (including one for just a moment) occurs during the operation, the operation restarts automatically when the power is restored in the same condition as before the power failure.



Note: It takes 3 minutes to restart the operation because the 3-minute standby function is activated.

2. Function of FFQ Series

2.1 Drain Pump Control

2.1.1 Normal Operation

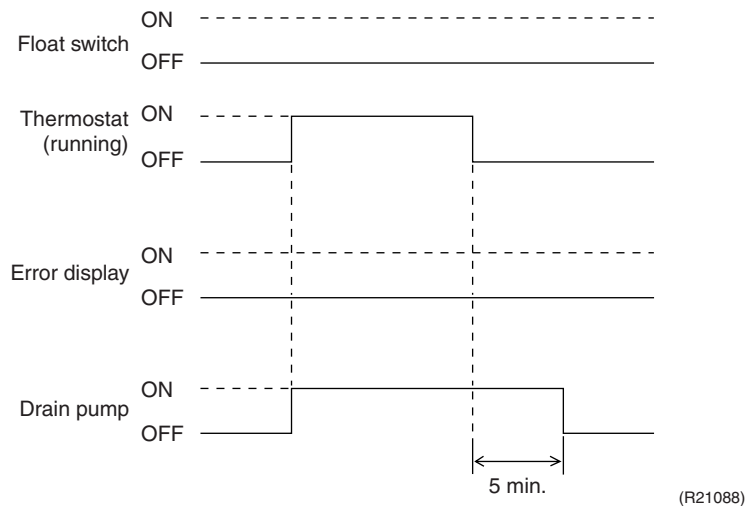

- ◆ The float switch is OFF in normal operation.
- ◆ When cooling operation starts (thermostat ON), the drain pump turns ON simultaneously.
- ◆ After the thermostat turns OFF, the drain pump continues to operate for another 5 minutes.
- ◆ The aim of residual operation after thermostat OFF is to eliminate the dew that condenses on the indoor heat exchanger during cooling operation.

2.1.2 If the Float Switch is ON with the Thermostat ON in Cooling Operation

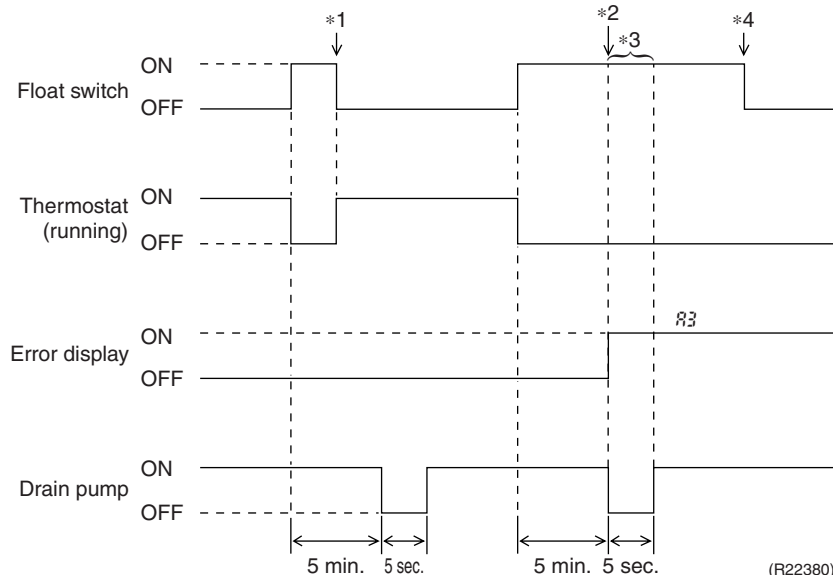

- ◆ When the float switch turns ON, the thermostat turns OFF simultaneously.
- ◆ After the thermostat turns OFF, the drain pump continues to operate for another 5 minutes.
- *1: If the float switch turns OFF again during the residual operation of the drain pump, cooling operation also turns on again (thermostat ON).
- *2: If the float switch remains ON even after the residual operation of the drain pump has ended, the error code R3 is displayed on the remote controller.
- *3: The drain pump turns OFF once residual operation has ended, then turns ON again after 5 seconds.
- *4: After R3 is displayed and the unit comes to an abnormal stop, the thermostat will remain OFF even if the float switch turns OFF again.

2.1.3 If the Float Switch is ON with the Thermostat OFF in Cooling Operation

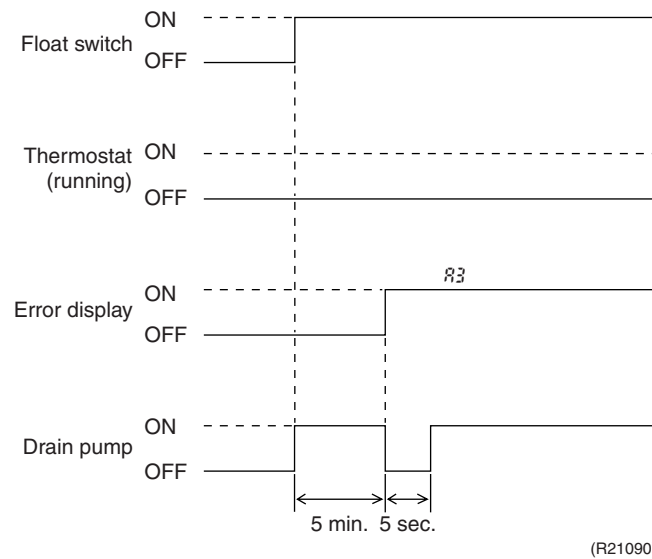

- ◆ When the float switch turns ON, the drain pump turns ON simultaneously.
- ◆ If the float switch remains ON even after the residual operation of the drain pump has ended, the error code $R3$ is displayed on the remote controller.
- ◆ The drain pump turns OFF once residual operation has ended, then turns ON again after 5 seconds.

2.1.4 If the Float Switch Turns ON and OFF Continuously, or the Float Switch Turns ON While Rf Displayed

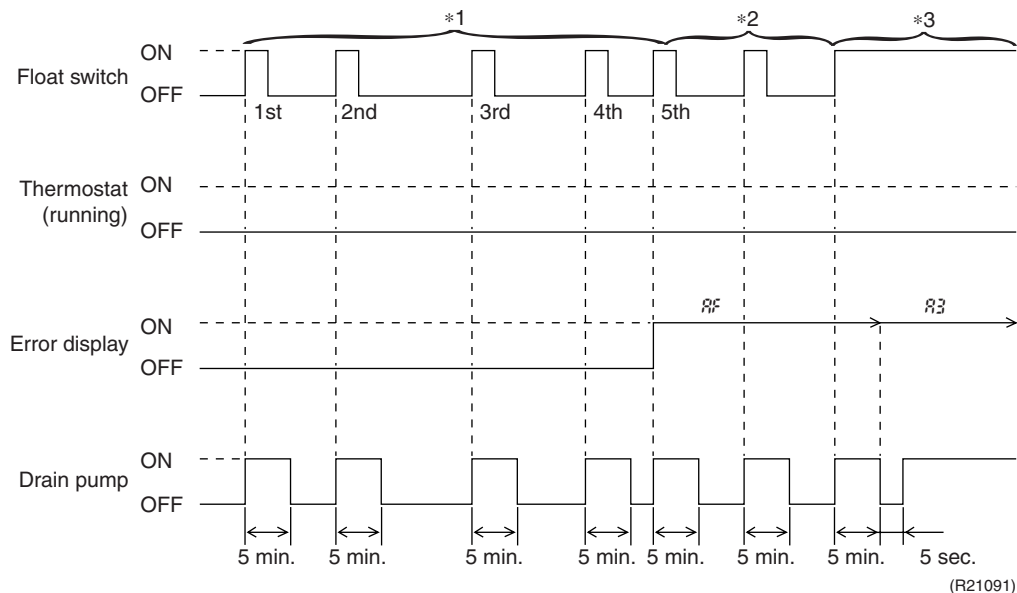

- ◆ When the float switch turns ON, the drain pump turns ON simultaneously.
- *1: If the float switch continues to turn ON and OFF 5 times consecutively, it is judged as a drain system error and the error code Rf is displayed on the remote controller.
- *2: The drain pump continues to turn ON/OFF in accordance with the float switch ON/OFF even after Rf is displayed on the remote controller.
- *3: While the error code Rf is displayed, if the float switch remains ON even after the residual operation of the drain pump has ended, the error code $R3$ will be displayed on the remote controller.

2.2 Thermostat Sensor in Remote Controller

Outline

Temperature is controlled by both the thermostat sensor in remote controller and air suction thermostat in the indoor unit. (This is however limited to when the field setting for the thermostat sensor in remote controller is set to Use.)

Cooling

If there is a significant difference in the set temperature and the suction temperature, fine adjustment control is carried out using a body thermostat sensor, or using the sensor in the remote controller near the position of the user when the suction temperature is near the set temperature.

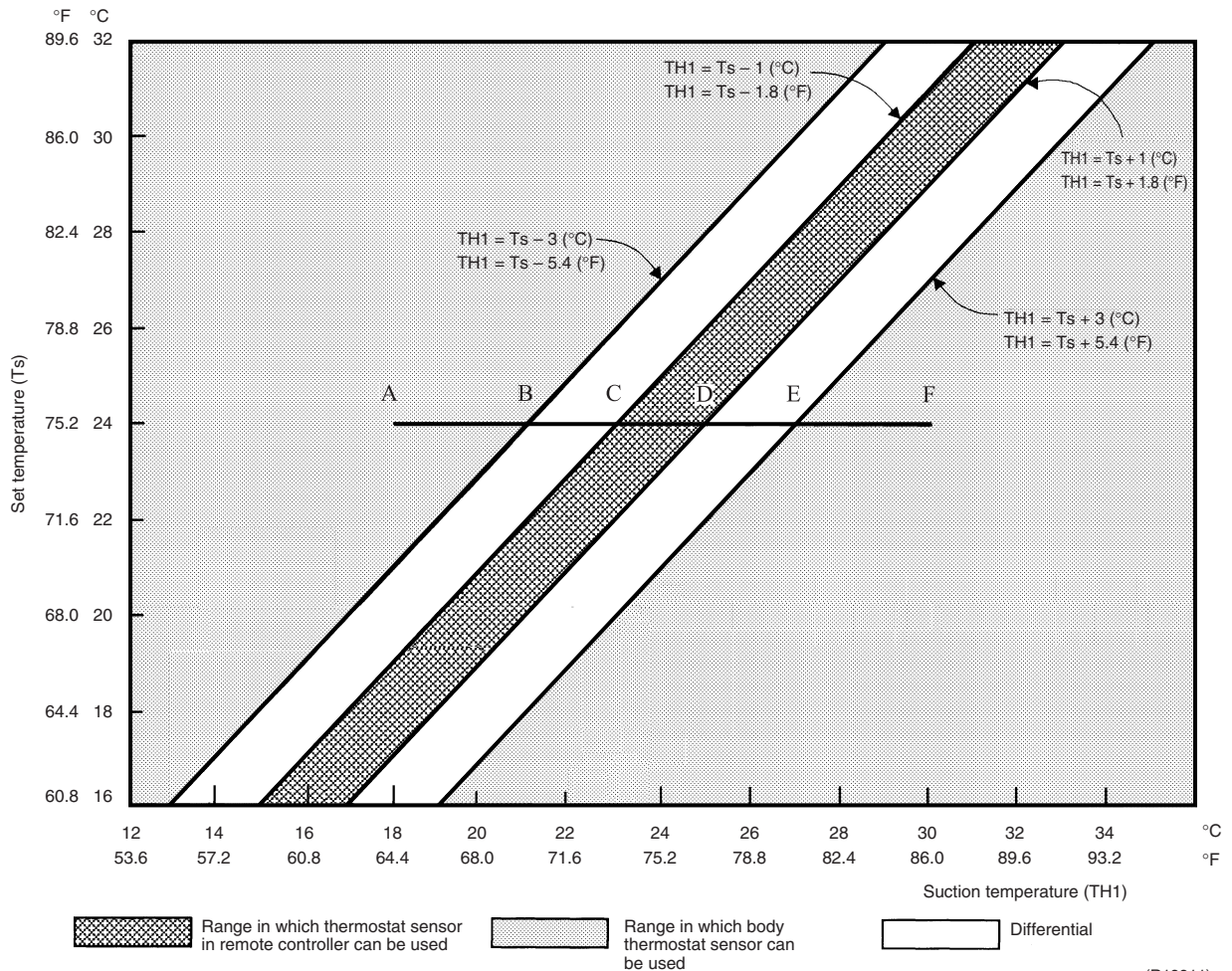

■ **Assuming the set temperature in the figure above is 24°C (75.2°F), and the suction temperature has changed from 18°C (64.4°F) to 30°C (86°F) (A → F):**

(This example also assumes there are several other air conditioners, and the suction temperature changes even when the thermostat sensor is off.)

18 → 23°C (64.4 → 73.4°F) (A → C): Body thermostat sensor is used.

23 → 27°C (73.4 → 80.6°F) (C → E): Remote controller thermostat sensor is used.

27 → 30°C (80.6 → 86°F) (E → F): Body thermostat sensor is used.

■ **Assuming suction temperature has changed from 30°C (86°F) to 18°C (64.4°F) (F → A):**

30 → 25°C (86 → 77°F) (F → D): Body thermostat sensor is used.

25 → 21°C (77 → 69.8°F) (D → B): Remote controller thermostat sensor is used.

21 → 18°C (69.8 → 64.4°F) (B → A): Body thermostat sensor is used.

Heating

When heating, the hot air rises to the top of the room, resulting in the temperature being lower near the floor where the occupants are. When controlling by body thermostat sensor only, the indoor unit may therefore be turned off by the thermostat before the lower part of the room reaches the set temperature. The temperature can be controlled so the lower part of the room where the occupants are does not become cold by widening the range in which thermostat sensor in remote controller can be used so that suction temperature is higher than the set temperature.

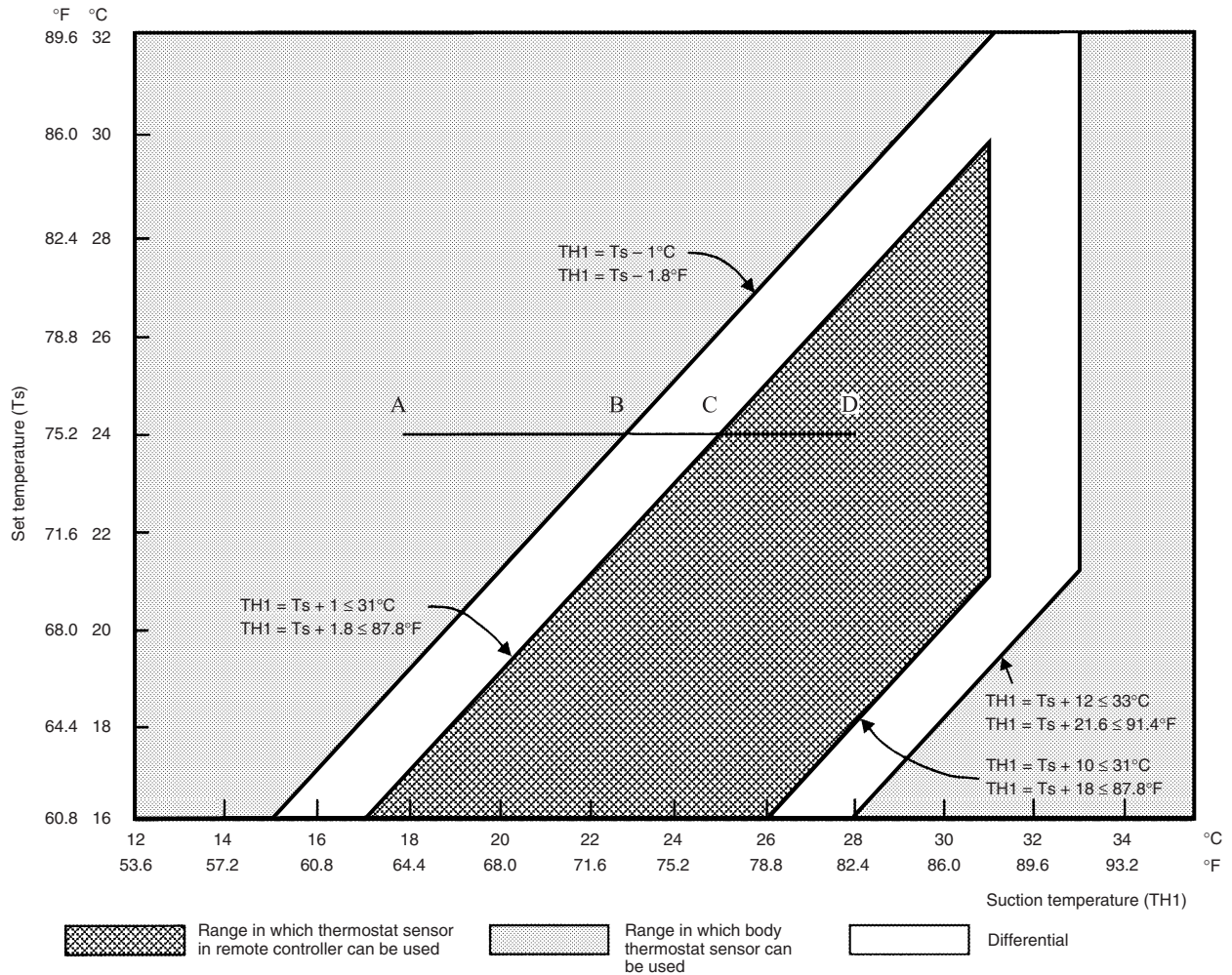

(R18812)

- Assuming the set temperature in the figure above is 24°C (75.2°F), and the suction temperature has changed from 18°C (64.4°F) to 28°C (82.4°F) (A → D):

(This example also assumes there are several other air conditioners, and the suction temperature changes even when the thermostat sensor is off.)

18 → 25°C (64.4 → 77°F) (A → C): Body thermostat sensor is used.

25 → 28°C (77 → 82.4°F) (C → D): Remote controller thermostat sensor is used.

- Assuming suction temperature has changed from 28°C (82.4°F) to 18°C (64.4°F) (D → A):

28 → 23°C (82.4 → 73.4°F) (D → B): Remote controller thermostat sensor is used.

23 → 18°C (73.4 → 64.4°F) (B → A): Body thermostat sensor is used.

2.3 Freeze Prevention Control

Outline

When the temperature detected by liquid pipe thermistor (R2T) of the indoor heat exchanger drops too low, the unit enters freeze prevention control in accordance with the following conditions, and is also set in accordance with the conditions given below.

Detail

Conditions for starting:

Liquid pipe temperature $\leq -1^{\circ}\text{C}$ (30.2°F) (for total of 40 minutes)

or

Liquid pipe temperature $\leq -5^{\circ}\text{C}$ (23°F) (for total of 10 minutes)

Condition for cancelling:

Liquid pipe temperature $\geq 7^{\circ}\text{C}$ (44.6°F) (for 10 minutes continuously)

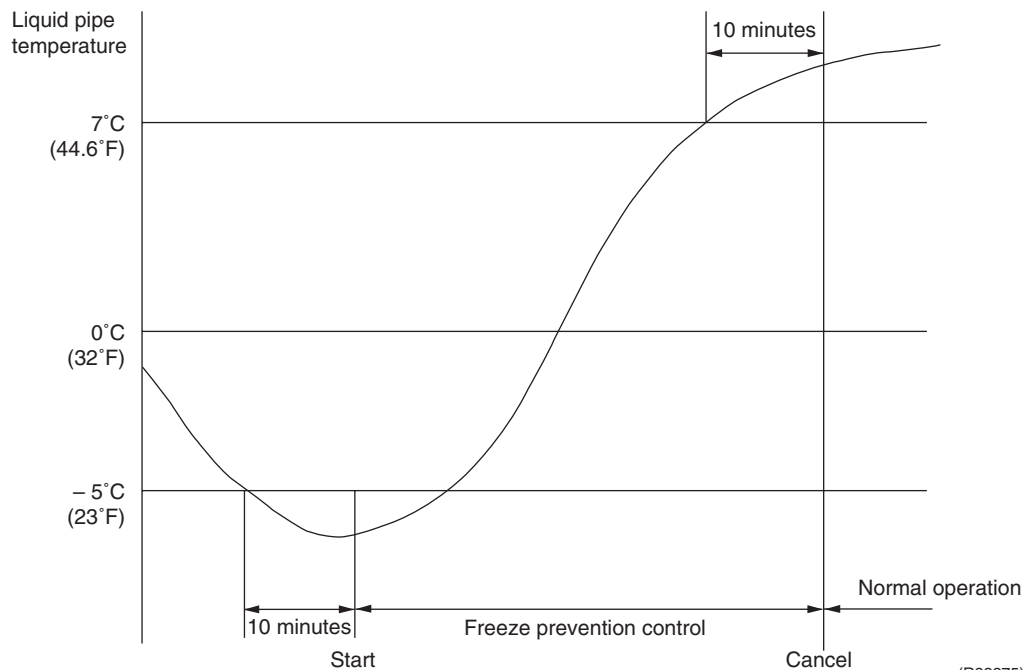

(R22275)

2.4 Hot Start Control (In Heating Operation Only)

Outline

At startup with thermostat ON or after the completion of defrosting in heating operation, the indoor unit fan is controlled to prevent cold air from blasting out and ensure startup capacity.

Detail

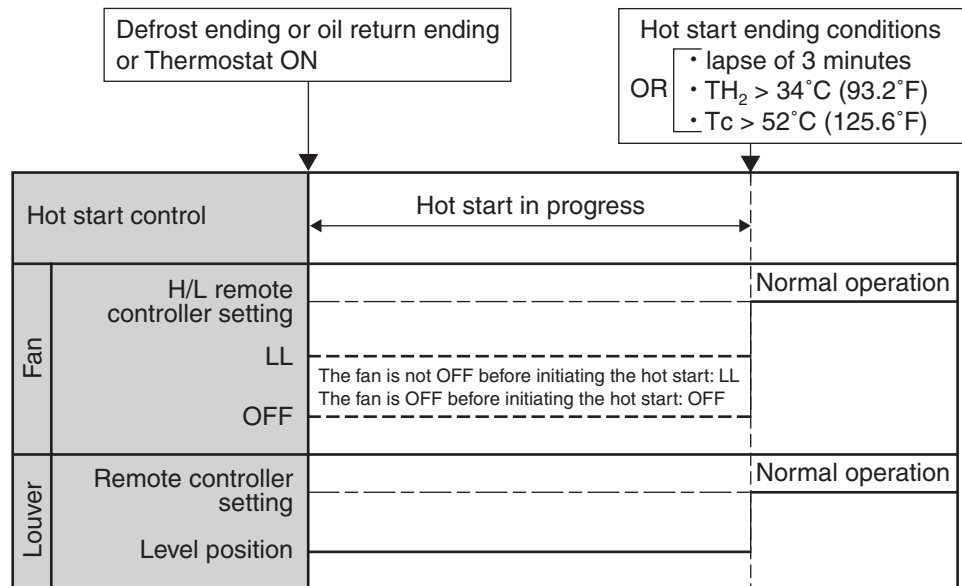

(R19187)

TH₂: Temperature detected by the gas thermistor
 T_c: High pressure equivalent saturation temperature

3. Control Specification

3.1 Function of Thermistor

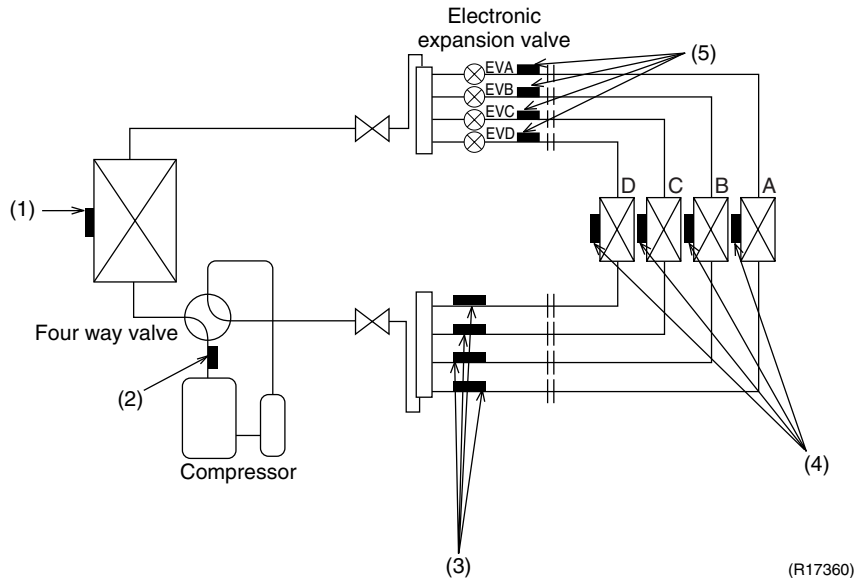

- ★ The illustration is for the 4-room models as representative and have 4 lines of indoor unit system (A ~ D). The 3-room models have 3 lines (A ~ C) and 2-room models have 2 lines (A ~ B).

(1) Outdoor Heat Exchanger Thermistor

1. The outdoor heat exchanger thermistor is used for controlling the target discharge pipe temperature. The system sets the target discharge pipe temperature according to the outdoor and indoor heat exchanger temperature, and controls the electronic expansion valve opening so that the target discharge pipe temperature can be obtained.
2. In cooling operation, the outdoor heat exchanger thermistor is used for detecting the disconnection of the discharge pipe thermistor. When the discharge pipe temperature drops below the outdoor heat exchanger temperature by more than a certain value, the discharge pipe thermistor is judged as disconnected.
3. In cooling operation, the outdoor heat exchanger thermistor is used for high pressure protection.

(2) Discharge Pipe Thermistor

1. The discharge pipe thermistor is used for controlling discharge pipe temperature. If the discharge pipe temperature (used in place of the inner temperature of the compressor) rises abnormally, the operating frequency becomes lower or the operation halts.
2. The discharge pipe thermistor is used for detecting disconnection of the discharge pipe thermistor.

(3) Gas Pipe Thermistor

In cooling operation, the gas pipe thermistor is used for gas pipe isothermal control. The system controls electronic expansion valve opening so that the gas pipe temperature in each room becomes equal.

(4) Indoor Heat Exchanger Thermistor

1. The indoor heat exchanger thermistor is used for controlling the target discharge pipe temperature. The system sets the target discharge pipe temperature according to the outdoor and indoor heat exchanger temperature, and controls the electronic expansion valve opening so that the target discharge pipe temperature can be obtained.
2. In cooling operation, the indoor heat exchanger thermistor is used for freeze-up protection control. If the indoor heat exchanger temperature drops abnormally, the operating frequency becomes lower or the operation halts.
3. In cooling operation, the indoor heat exchanger thermistor is used for anti-icing function. If any of the following conditions are met in the room where operation halts, it is assumed as icing. The conditions are
$$T_c \leq -1^\circ \text{C} (30.2^\circ \text{F})$$
$$T_a - T_c \geq 10^\circ \text{C} (18^\circ \text{F})$$
where T_a is the room temperature and T_c is the indoor heat exchanger temperature.
4. In heating operation, the indoor heat exchanger thermistor is used for heating peak-cut control. If the indoor heat exchanger temperature rises abnormally, the operating frequency becomes lower or the operation halts.
5. In heating operation, the indoor heat exchanger thermistor is used for detecting the disconnection of the discharge pipe thermistor. When the discharge pipe temperature drops below the highest indoor heat exchanger temperature by more than a certain value, the discharge pipe thermistor is judged as disconnected.
6. When only one indoor unit is operating, the indoor heat exchanger thermistor is used for subcooling control. The actual subcool is calculated with the liquid pipe temperature and the indoor heat exchanger temperature. The system controls the electronic expansion valve openings to obtain the target subcool.
7. The indoor heat exchanger thermistor is used for wiring error check function. The refrigerant flows in order from the port A to detect the indoor heat exchanger temperature one by one, and then wiring and piping can be checked.

(5) Liquid Pipe Thermistor

1. When only one indoor unit is in heating, the liquid pipe thermistor is used for subcooling control. The actual subcool is calculated with the liquid pipe temperature and the maximum indoor heat exchanger temperature. The system controls the electronic expansion valve openings to obtain the target subcool.
2. In heating operation, the liquid pipe thermistor is used for liquid pipes isothermal control. The system controls the electronic expansion valve opening so that the liquid pipe temperatures in each room becomes equal.

3.2 Mode Hierarchy

Outline

Air conditioner control has normal operation mode, forced operation mode, and power transistor test mode for installation and servicing.

Detail

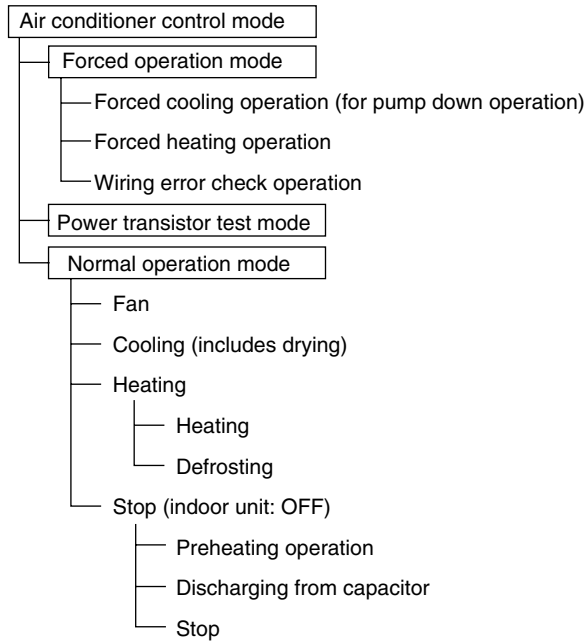

(R17361)



- Note:**
- Unless specified otherwise, a dry operation command is regarded as cooling operation.
 - Indoor fan operation cannot be made in multiple indoor units. (A forced fan command is made during forced cooling operation.)

Determine Operation Mode

The system judges the operation mode command which is set by each room in accordance with the procedure, and determines the operation mode of the system.

The following procedure is taken when the modes conflict with each other.

*1. The system follows the mode which is set first. (First-push, first-set)

*2. For the rooms where the different mode is set, standby mode is activated. (The operation lamp blinks.)

3.3 Frequency Control

Outline

Frequency that corresponds to each room's capacity is determined according to the difference between the target temperature and the temperature of each room.

When the shift of the frequency is less than zero ($\Delta F < 0$) by PI control, the target frequency is used as the command frequency.

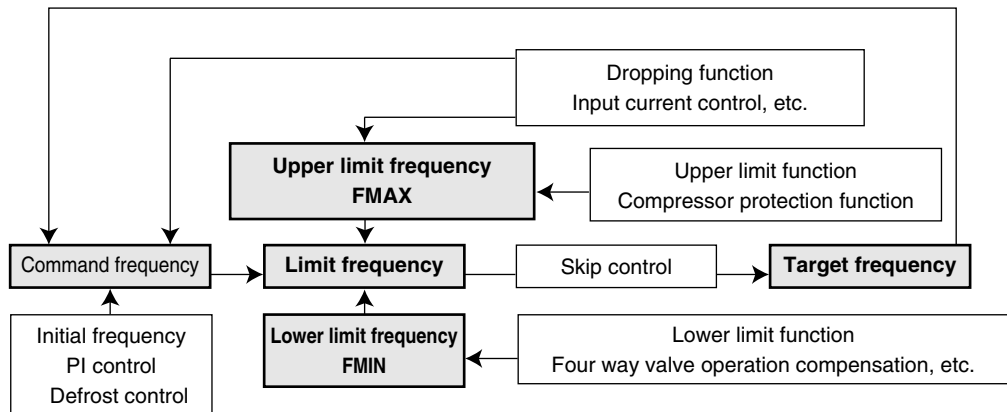

Detail

The compressor's frequency is determined by taking the following steps.

1. Determine command frequency

Command frequency is determined in the following order of priority.

1. Limiting defrost control time
2. Forced cooling / heating
3. Indoor frequency command

2. Determine upper limit frequency

The minimum value is set as upper limit frequency among the frequency upper limits of the following functions:

Compressor protection, input current, discharge pipe temperature, low Hz high pressure limit, heating peak-cut, freeze-up protection, defrost.

3. Determine lower limit frequency

The maximum value is set as the lower limit frequency among the frequency lower limits of the following functions:

Four way valve operation compensation, draft prevention, pressure difference upkeep.

4. Determine prohibited frequency

There is a certain prohibited frequency such as a power supply frequency.

Parameters**<Q value>**

Indoor unit output determined from indoor unit volume, airflow rate and other factors.

<S value: Indoor Unit Capacity>

An S value is the capacity of the indoor unit, and is used for frequency command.

Ex:

Capacity	S value	Capacity	S value
9 kBtu/h	25	18 kBtu/h	50
12 kBtu/h	35	24 kBtu/h	60

< Δ D signal: Indoor frequency command>

The difference between the room thermistor temperature and the target temperature is recognized as the Δ D signal and is used for frequency command.

Temperature difference	Δ D signal	Temperature difference	Δ D signal	Temperature difference	Δ D signal	Temperature difference	Δ D signal
-2.0°C (-3.6°F)	*OFF	0°C (0°F)	4	2.0°C (3.6°F)	8	4.0°C (7.2°F)	C
-1.5°C (-2.7°F)	1	0.5°C (0.9°F)	5	2.5°C (4.5°F)	9	4.5°C (8.1°F)	D
-1.0°C (-1.8°F)	2	1.0°C (1.8°F)	6	3.0°C (5.4°F)	A	5.0°C (9°F)	E
-0.5°C (-0.9°F)	3	1.5°C (2.7°F)	7	3.5°C (6.3°F)	B	5.5°C (9.9°F)	F

Values depend on the type of indoor unit.

*OFF = Thermostat OFF

Initial Frequency

When starting the compressor, or when conditions are varied due to a change of operating rooms, the frequency must be initialized according to a total of the maximum Δ D value of each room and a total Q value (Σ Q) of the operating room (the room in which the thermostat is set to ON).

PI Control**1. P control**

The $\Sigma\Delta$ D value is calculated in each sampling time (20 seconds), and the frequency is adjusted according to its difference from the frequency previously calculated.

2. I control

If the operating frequency does not change for more than a certain fixed time, the frequency is adjusted according to the $\Sigma\Delta$ D value.

When the $\Sigma\Delta$ D value is low, the frequency is lowered.

When the $\Sigma\Delta$ D value is high, the frequency is increased.

3. Limit of frequency increasing range

When the difference between the input current and the dropping value of the input current is less than 1.5 A, the frequency increasing range must be limited.

4. Frequency control when other controls are functioning

- ◆ When frequency is dropping;
Frequency control is carried out only when the frequency drops.
- ◆ For limiting lower limit;
Frequency control is carried out only when the frequency rises.

5. Upper and lower limit of frequency by PI control

The frequency upper and lower limits are set according to the total of S values. When the indoor unit quiet operation commands come from more than one room or when the outdoor unit quiet operation commands come from all the rooms, the upper limit frequency is lower than the usual setting.

3.4 Controls at Mode Changing / Start-up

3.4.1 Preheating Control

Outline The inverter operation in open phase starts with the conditions of the outdoor temperature and the preheating command from the indoor unit.

Detail

ON Condition

- ◆ When the outdoor temperature is below 20°C (68°F), the inverter operation in open phase starts.

OFF Condition

- ◆ When the outdoor temperature is higher than 22°C (71.6°F), the inverter operation in open phase stops.

3.4.2 Four Way Valve Switching

Outline The four way valve coil is energized / not energized depending on the operation. (Heating: ON, Cooling / Dry / Defrost: OFF) In order to eliminate the switching sound as the four way valve coil switches from ON to OFF when the heating is stopped, the OFF delay switch of the four way valve is carried out.

Detail

OFF delay switch of four way valve:

The four way valve coil is energized for 150 seconds after the operation is stopped.

3.4.3 Four Way Valve Operation Compensation

Outline At the beginning of the operation as the four way valve is switched, the pressure difference to activate the four way valve is acquired when the output frequency is higher than a certain fixed frequency, for a certain fixed time.

Detail

Starting Conditions

1. When the compressor starts and the four way valve switches from OFF to ON
2. When the four way valve switches from ON to OFF during operation
3. When the compressor starts after resetting
4. When the compressor starts after the fault of four way valve switching

The lower limit of frequency keeps **A** Hz for 70 seconds with any conditions 1 through 4 above.

A (Hz)	Cooling	Heating
18 class	74	62
24/36 class	42	35

3.4.4 3-Minute Standby

Turning on the compressor is prohibited for 3 minutes after turning off.
(The function is not used when defrosting.)

3.4.5 Compressor Protection Function

When turning the compressor from OFF to ON, the upper limit of frequency is set as follows.
(The function is not used when defrosting.)

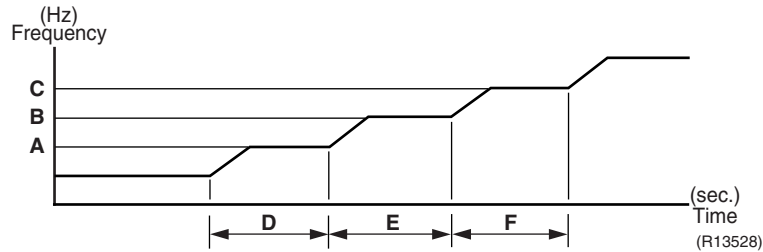

	18 class	24/36 class
A (Hz)	55	35 ~ 55
B (Hz)	65	48 ~ 65
C (Hz)	80	70 ~ 80
D (seconds)	180	120
E (seconds)	360	200 ~ 500
F (seconds)	400	180 ~ 470

3.5 Discharge Pipe Temperature Control

Outline

The discharge pipe temperature is used as the internal temperature of the compressor. If the discharge pipe temperature rises above a certain level, the upper limit of frequency is set to keep the discharge pipe temperature from rising further.

Detail

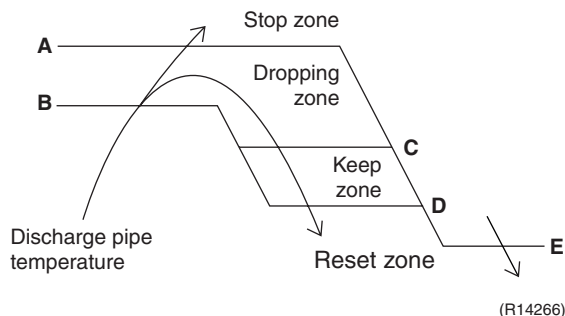

	18 class	24/36 class
A	120°C (248°F)	120°C (248°F)
B	103°C (217.4°F)	111°C (231.8°F)
C	102°C (215.6°F)	109°C (228.2°F)
D	100°C (212°F)	107°C (224.6°F) ★
E	95°C (203°F)	107°C (224.6°F) ★

★ The same value continues.

Zone	Control
Stop zone	When the temperature reaches the stop zone, the compressor stops.
Dropping zone	The upper limit of frequency decreases.
Keep zone	The upper limit of frequency is kept.
Reset zone	The upper limit of frequency is canceled.

3.6 Input Current Control

Outline

The microcomputer calculates the input current while the compressor is running, and sets the frequency upper limit based on the input current.

In case of heat pump models, this control is the upper limit control of frequency and takes priority over the lower limit control of four way valve operation compensation.

Detail

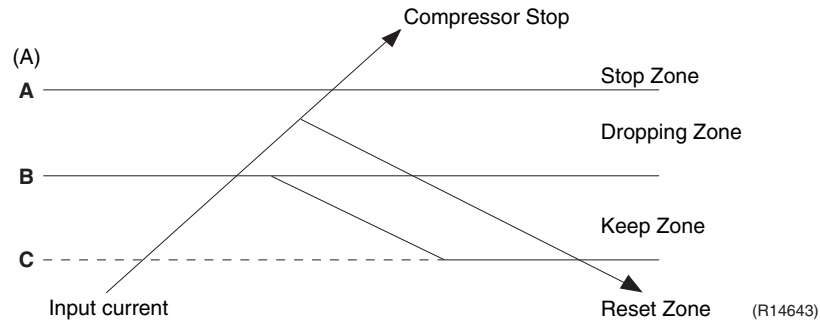

Frequency control in each zone

Stop zone

- After 2.5 seconds in this zone, the compressor is stopped.

Dropping zone

- The upper limit of the compressor frequency is defined as operation frequency – 2 Hz.
- After this, the output frequency is lowered by 2 Hz every second until it reaches the keep zone.

Keep zone

- The present maximum frequency goes on.

Reset zone

- Limit of the frequency is canceled.

	18 class		24 class		36 class	
	Cooling	Heating	Cooling	Heating	Cooling	Heating
A (A)	13.0	15.0	15.5	17.5	18.0	18.5
B (A)	11.5	14.0	14.0	15.5	17.0	17.5
C (A)	10.5	13.0	13.0	14.5	16.0	16.5

Limitation of current dropping and stop value according to the outdoor temperature

- The current drops when outdoor temperature becomes higher than a certain level (depending on the model).

3.7 Freeze-up Protection Control

Outline During cooling operation, the signals sent from the indoor units control the operating frequency limitation and prevent freezing of the indoor heat exchanger. (The signals from the indoor units are divided into zones.)

Detail The operating frequency limitation is judged with the indoor heat exchanger temperature 2 seconds after operation starts and 30 seconds after the number of operation room is changed.

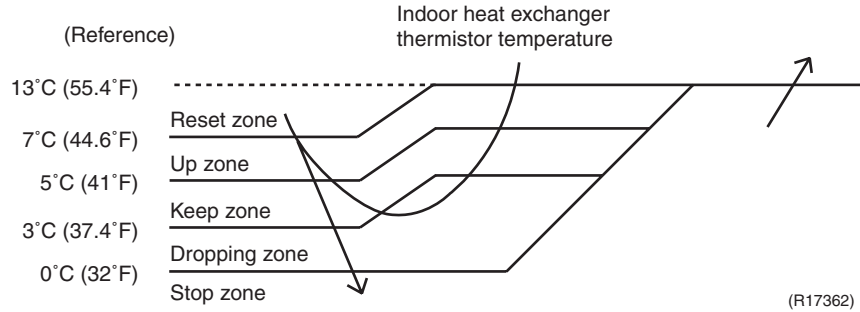

3.8 Heating Peak-cut Control

Outline During heating operation, the indoor heat exchanger temperature determines the frequency upper limit to prevent abnormal high pressure.

- Detail**
- The operating frequency is judged with the indoor heat exchanger temperature 2 minutes after the operation starts and F seconds after the number of operation room is changed.
 - The maximum value of the indoor heat exchanger temperature controls the following (excluding stopped rooms).

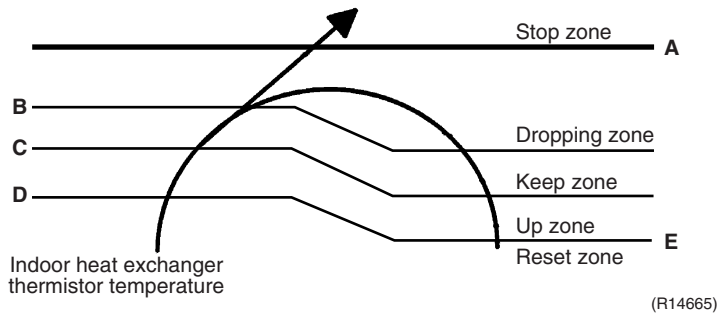

A	65°C (149°F)
B	55°C (131°F)
C	54°C (129.2°F)
D	52°C (125.6°F)
E	50°C (122°F)

	F (seconds)
When increase	30
When decrease	2

Zone	Control
Stop zone	When the temperature reaches the stop zone, the compressor stops.
Dropping zone	The upper limit of frequency decreases.
Keep zone	The upper limit of frequency is kept.
Up zone	The upper limit of frequency increases.
Reset zone	The upper limit of frequency is canceled.

3.9 Outdoor Fan Control

1. Fan ON control to cool down the electrical box

The outdoor fan is turned ON when the electrical box temperature is high while the compressor is OFF.

2. Fan OFF control during defrosting

The outdoor fan is turned OFF while defrosting.

3. Fan OFF delay when stopped

The outdoor fan is turned OFF 60 seconds after the compressor stops.

4. Fan speed control for pressure difference upkeep

The rotation speed of the outdoor fan is controlled for keeping the pressure difference during cooling operation with low outdoor temperature.

- ◆ When the pressure difference is low, the rotation speed of the outdoor fan is reduced.
- ◆ When the pressure difference is high, the rotation speed of the outdoor fan is controlled as well as normal operation.

5. Fan control when the number of heating room decreases

When the outdoor temperature is more than 10°C (50°F), the fan is turned off for 30 seconds.

6. Fan speed control during forced operation

The outdoor fan is controlled as well as normal operation during the forced operation.

7. Fan speed control during POWERFUL operation

The rotation speed of the outdoor fan is increased during the POWERFUL operation.

8. Fan speed control during indoor / outdoor unit quiet operation

The rotation speed of the outdoor fan is reduced by the command of the indoor / outdoor unit quiet operation.

9. Fan ON/OFF control when operation (cooling, heating, dry) starts / stops

The outdoor fan is turned ON when the operation starts. The outdoor fan is turned OFF when the operation stops.

3.10 Liquid Compression Protection Function

Outline

The compressor stops according to the outdoor temperature for protection.

Detail

- Operation stops depending on the outdoor temperature.

The compressor turns off under the conditions that the system is in cooling operation and the outdoor temperature is below -12°C (10.4°F).

3.11 Defrost Control

Outline

Defrosting is carried out by the cooling cycle (reverse cycle). The defrosting time or outdoor heat exchanger temperature must be more than a certain value to finish defrosting.

Detail

Conditions for Starting Defrost

- The starting conditions are determined with the outdoor temperature and the outdoor heat exchanger temperature.
- The system is in heating operation.
- The compressor operates for 6 minutes.
- More than **A** minutes of accumulated time have passed since the start of the operation, or ending the previous defrosting.

Conditions for Canceling Defrost

The judgment is made with the outdoor heat exchanger temperature. (**B**°C (**C**°F))

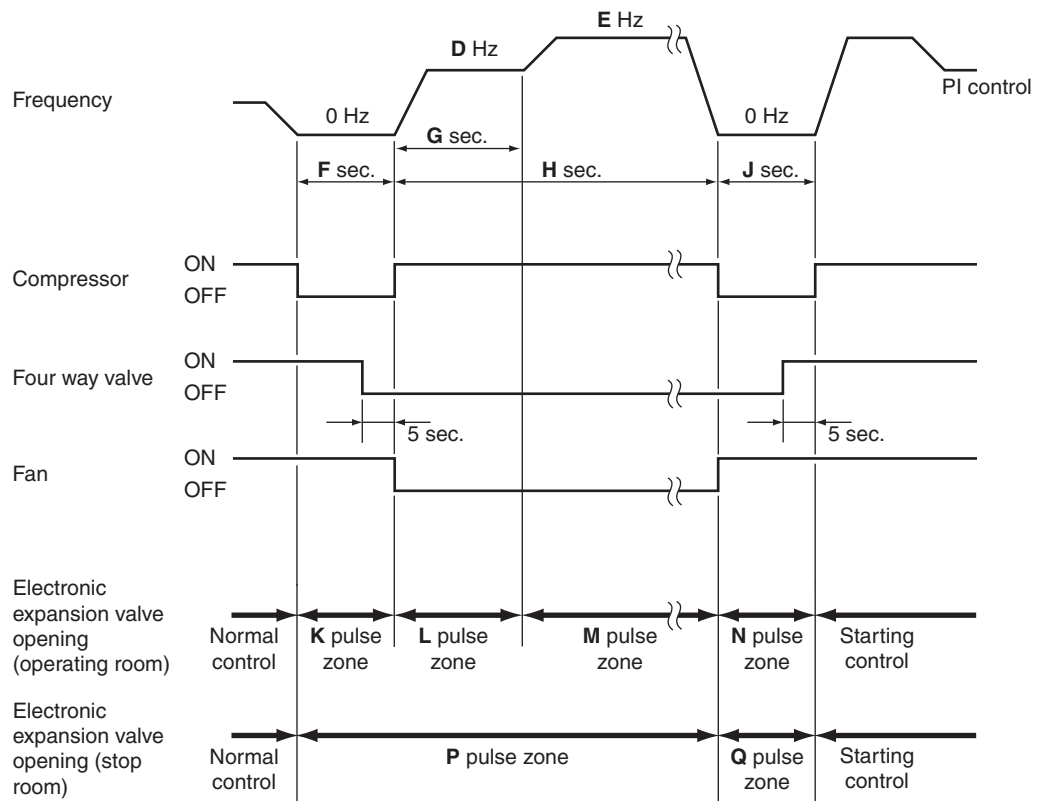

(R21926)

	18 class	24/36 class
A (minutes)	33	26
B (°C)	4 ~ 12	4 ~ 12
C (°F)	39.2 ~ 53.6	39.2 ~ 53.6
D (Hz)	58	58
E (Hz)	74	42
F (seconds)	60	90
G (seconds)	120	60
H (seconds)	650	590
J (seconds)	80	40
K (pulse)	320	400
L (pulse)	300 ★	250
M (pulse)	300 ★	300
N (pulse)	320	400
P (pulse)	160 ★	50
Q (pulse)	160 ★	0

★: The same value continues.

3.12 Low Hz High Pressure Limit

Outline

The system controls the upper limit of the frequency to prevent abnormal high pressure while the frequency is low. Control is carried out according to three zones.

Detail

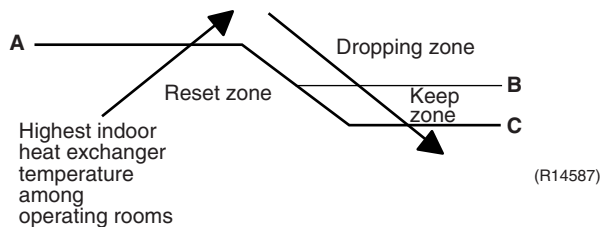

	18 class	24/36 class
A	60°C (140°F)	38.5°C (101.3°F)
B	59°C (138.2°F)	37.5°C (99.5°F)
C	56°C (132.8°F)	34.5°C (94.1°F)

3.13 Electronic Expansion Valve Control

Outline

The following items are included in the electronic expansion valve control.

Electronic expansion valve is fully closed

1. Electronic expansion valve is fully closed when turning on the power.
2. Pressure equalizing control

Room Distribution Control

1. Gas pipe isothermal control
2. SC (subcooling) control
3. Liquid pipe temperature control (with all ports connected and all rooms being air-conditioned)
4. Liquid pipe temperature control for stopped rooms
5. Dew prevention control for indoor rotor

Open Control

1. Electronic expansion valve control when starting operation
2. Electronic expansion valve control when the frequency changes
3. Electronic expansion valve control for defrosting
4. Electronic expansion valve control for oil recovery
5. Electronic expansion valve control when a discharge pipe temperature is abnormally high
6. Electronic expansion valve control when the discharge pipe thermistor is disconnected
7. Electronic expansion valve control for indoor unit freeze-up protection

Feedback Control

Target discharge pipe temperature control

Detail

The followings are the examples of electronic expansion valve control which function in each operation mode.

Operation pattern		Gas pipe isothermal control	SC (subcooling) control	Control when the frequency changes	Control for abnormally high discharge pipe temperature	Oil recovery control	Indoor freeze-up protection control	Liquid pipe temperature control	Liquid pipe temperature control for non-operating units	Dew prevention control for indoor rotor
● : Available — : Not available										
When power is turned on	Fully closed when power is turned on	—	—	—	—	—	—	—	—	—
Cooling, 1 room operation	Open control when starting	—	—	—	●	●	●	—	—	—
	(Control of target discharge pipe temperature)	—	—	●	●	●	●	—	—	●
Cooling, 2 rooms operation to Cooling, 4 rooms operation	Control when the operating room is changed	—	—	—	●	●	●	—	—	●
	(Control of target discharge pipe temperature)	●	—	●	●	●	●	—	—	●
Stop	Pressure equalizing control	—	—	—	—	—	—	—	—	—
Heating, 1 room operation	Open control when starting	—	—	—	●	—	—	—	—	—
	(Control of target discharge pipe temperature)	—	★2	●	●	—	—	★1	★3	—
Heating, 2 rooms operation	Control when the operating room is changed	—	—	—	●	—	—	—	—	—
	(Control of target discharge pipe temperature)	—	★2	●	●	—	—	★1	★3	—
	(Defrost control)	—	—	—	—	—	—	—	—	—
Stop	Pressure equalizing control	—	—	—	—	—	—	—	—	—
Heating operation	Open control when starting	—	—	—	●	—	—	—	—	—
	Continue	—	●	—	—	—	—	●	●	—
Discharge pipe thermistor disconnection control	Pressure equalizing control	—	—	—	—	—	—	—	—	—
Stop	Pressure equalizing control	—	—	—	—	—	—	—	—	—

(R21181)

- ★1 : When all the indoor units are operating, liquid pipe temperature control is conducted.
- ★2 : SC (subcooling) control is conducted for the operating indoor units, when some of the units are not operating.
- ★3 : Liquid pipe temperature control for stopped room is conducted for the non-operating indoor units.

3.13.1 Fully Closing with Power on

The electronic expansion valve is initialized when the power is turned on. The opening position is set and the pressure equalization is developed.

3.13.2 Pressure Equalizing Control

When the compressor is stopped, the pressure equalizing control is activated. The electronic expansion valve opens, and develops the pressure equalization.

3.13.3 Opening Limit Control

Outline The maximum and minimum opening of the electronic expansion valve are limited.

Detail

- Maximum electronic expansion valve opening in the operating room: 450 pulse
- Minimum electronic expansion valve opening in the operating room: 64 pulse

The electronic expansion valve is fully closed in a room where cooling operation is stopped and is opened at a fixed degree during defrosting.

3.13.4 Starting Operation Control / Changing Operation Room

The electronic expansion valve opening is controlled when the operation starts, and prevents superheating or liquid compression.

3.13.5 Control when the Frequency Changes

When the target discharge pipe temperature control is active, if the target frequency is changed to a specified value in a certain time period, the target discharge pipe temperature control is canceled and the target opening of the electronic expansion valve is changed.

3.13.6 Oil Recovery Function

Outline The electronic expansion valve opening in the cooling stopped room is set as to open for a certain time at a specified interval so that the oil in the cooling stopped room may not be accumulated.

Detail During cooling operation, every 1 hour continuous operation, the electronic expansion valves in the operation stopped room is opened by 80 pulses for specified time.

3.13.7 High Discharge Pipe Temperature Control

When the compressor is operating, if the discharge pipe temperature exceeds a certain value, the electronic expansion valve opens and the refrigerant runs to the low pressure side. This procedure lowers the discharge pipe temperature.

3.13.8 Discharge Pipe Thermistor Disconnection Control

Outline

The disconnection of the discharge pipe thermistor is detected by comparing the discharge pipe temperature with the condensing temperature. If the discharge pipe thermistor is disconnected, the electronic expansion valve opens according to the outdoor temperature and the operation frequency, operates for a specified time, and then stops.

After 3 minutes, the operation restarts and checks if the discharge pipe thermistor is disconnected. If the discharge pipe thermistor is disconnected, the system stops after operating for a specified time.

If the disconnection is detected repeatedly, the system is shut down. When the compressor runs for 60 minutes without any error, the error counter is reset.

Detail

Determining thermistor disconnection

When the starting control (660 ~ 690 seconds, depending on the model) finishes, the following adjustment is made.

1. When the operation mode is cooling

When the following condition is fulfilled, the discharge pipe thermistor disconnection is ascertained.

Discharge pipe temperature + 6°C (10.8°F) < outdoor heat exchanger temperature

2. When the operation mode is heating

When the following condition is fulfilled, the discharge pipe thermistor disconnection is ascertained.

Discharge pipe temperature + 6°C (10.8°F) < highest indoor heat exchanger temperature

When the thermistor is disconnected

When the disconnection is ascertained, the compressor continues operation for 9 minutes and then stops.

3.13.9 Gas Pipe Isothermal Control During Cooling

When the units are operating in multiple rooms, the gas pipe temperature is detected and the electronic expansion valve opening is adjusted so that the temperature of the gas pipe in each room becomes equal.

- When the gas pipe temperature > the average gas pipe temperature,
→ the opening degree of electronic expansion valve in the corresponding room increases.
- When the gas pipe temperature < the average gas pipe temperature,
→ the opening degree of electronic expansion valve in the corresponding room decreases.

The temperatures are monitored every 40 seconds.

3.13.10 SC (Subcooling) Control

Outline

The liquid pipe temperature and the heat exchanger temperature are detected and the electronic expansion valve opening is compensated so that the SC of each room becomes the target SC.

- When the actual SC is > target SC, open the electronic expansion valve of the room.
- When the actual SC is < target SC, close the electronic expansion valve of the room.

Detail

Start Conditions

After finishing the starting control (660 ~ 690 seconds, depending on the model), (all) the electronic expansion valve(s) for the operating room is/are controlled.

Determine Electronic Expansion Valve Opening

The electronic expansion valve opening is adjusted so that the temperature difference between the maximum heat exchanger temperature of connected room and the liquid pipe temperature thermistor becomes constant.

3.13.11 Target Discharge Pipe Temperature Control

The target discharge pipe temperature is obtained from the indoor and outdoor heat exchanger temperature, and the electronic expansion valve opening is adjusted so that the actual discharge pipe temperature becomes close to the target discharge pipe temperature. (Indirect SH (superheating) control using the discharge pipe temperature)

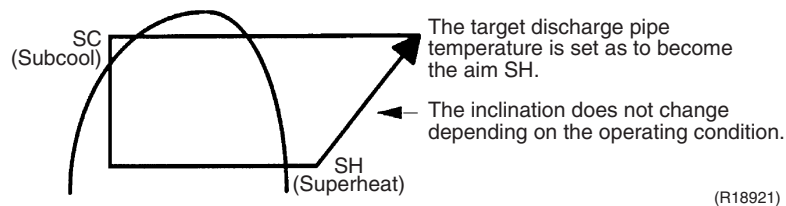

The electronic expansion valve opening and the target discharge pipe temperature are adjusted every 20 seconds. The target discharge pipe temperature is controlled by indoor heat exchanger temperature and outdoor heat exchanger temperature. The opening degree of the electronic expansion valve is controlled by the followings.

- ◆ Target discharge pipe temperature
- ◆ Actual discharge pipe temperature
- ◆ Previous discharge pipe temperature

3.14 Malfunctions

3.14.1 Sensor Malfunction Detection

Sensor malfunction may occur either in the thermistor or current transformer (CT) system.

Relating to Thermistor Malfunction

1. Outdoor heat exchanger thermistor
2. Discharge pipe thermistor
3. Radiation fin thermistor
4. Gas pipe thermistor
5. Outdoor temperature thermistor
6. Liquid pipe thermistor



Relating to CT Malfunction

Refer to CT or related abnormality on page 158 for detail.

3.14.2 Detection of Overcurrent and Overload

Outline

In order to protect the inverter, an excessive output current is detected and the OL temperature is observed to protect the compressor.

Detail

- If the inverter current exceeds 13.0 ~ 18.5 A (depending on the model), the system shuts down the compressor.
- If the OL (compressor head) temperature exceeds 130°C (266°F), the compressor stops.

3.14.3 Refrigerant Shortage Control

Outline

If the power consumption is below the specified value and the frequency is higher than the specified frequency, it is regarded as refrigerant shortage.

The power consumption is low comparing with that in the normal operation when refrigerant is insufficient, and refrigerant shortage is detected by checking power consumption.

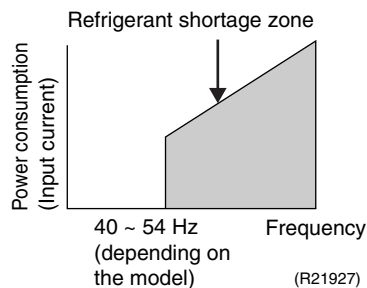

Refer to Refrigerant shortage on page 136 for detail.

3.14.4 Anti-icing Function

During cooling, if the indoor heat exchanger temperature in the operation stopped room drops below the specified temperature for a specified time, the electronic expansion valve is opened in the operation stopped room as specified, and the fully closed operation is carried out. After this, if freezing abnormality occurs longer than a specified time, the system is shut down.

Part 5

Remote Controller

1. CTXS, FTXS Series	79
2. CDXS, FDXS Series	81
3. FVXS Series.....	83
4. FFQ Series.....	85
4.1 <BRC1E71> Wired Remote Controller.....	85
4.2 <BRC1E72/73> Wired Remote Controller.....	90
4.3 <BRC7E830> Wireless Remote Controller	96

1. CTXS, FTXS Series

Signal transmitter

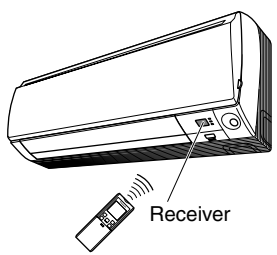

- To use the remote controller, aim the transmitter at the indoor unit. If there is anything to block signals between the unit and the remote controller, such as a curtain, the unit will not operate.
- Do not drop the remote controller. Do not get it wet.
- The maximum distance for communication is approximately 23 ft. (7 m).

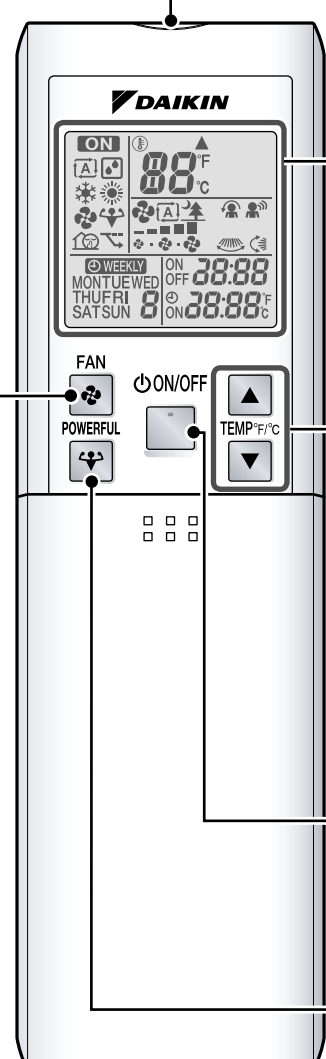

Display (LCD)

- Displays the current settings. (In this illustration, each section is shown with all its displays on for the purpose of explanation.)

FAN setting button

- Selects the airflow rate setting every time you press this button.

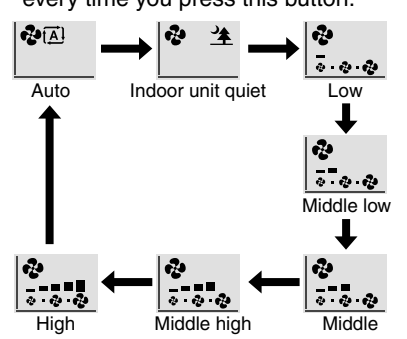

- In indoor unit quiet operation, operation sound becomes weak. (The airflow rate also decreases.)
- In DRY operation, the airflow rate setting is not available.

TEMPERATURE adjustment buttons

- Changes the temperature setting.

Ⓐ : AUTO	18 ~ 30 °C (64 ~ 86 °F)
☐ : DRY	Not available
❄ : COOL	18 ~ 32 °C (64 ~ 90 °F)
☀ : HEAT	10 ~ 30 °C (50 ~ 86 °F)
🌀 : FAN	Not available

ON/OFF button

- Press this button once to start operation. Press once again to stop it.

POWERFUL*1 button

- POWERFUL operation.

< ARC452A21 >

(R18852)

Reference

Refer to the following pages for detail.

★1	Inverter POWERFUL operation	P.45
----	-----------------------------	------



Note: Refer to the operation manual of applicable model for detail. You can download operation manuals from Daikin Business Portal:
 Daikin Business Portal → Product Information → Operation/Installation Manual
 (URL: https://global1d.daikin.com/business_portal/login/)

Open the Front Cover



MODE button

- Selects the operation mode.

QUIET button

- OUTDOOR UNIT QUIET operation.
- OUTDOOR UNIT QUIET operation is not available in FAN and DRY operation.
- OUTDOOR UNIT QUIET operation and POWERFUL operation cannot be used at the same time. Priority is given to the function you pressed last.

ECONO*4 button

- ECONO operation.

SWING*5 button

- Adjusts the airflow direction.
- When you press the **SWING** button, the flap moves up and down, or (and) the louver moves right and left. The flap (louver) stops when you press the **SWING** button again.

COMFORT*2/SENSOR*3 button

- Every time you press the **COMFORT/SENSOR** button, the setting changes in the following order.

WEEKLY button

- WEEKLY : **WEEKLY** button
- PROGRAM button
- COPY : **COPY** button
- BACK : **BACK** button
- NEXT : **NEXT** button
- WEEKLY TIMER*6 operation.

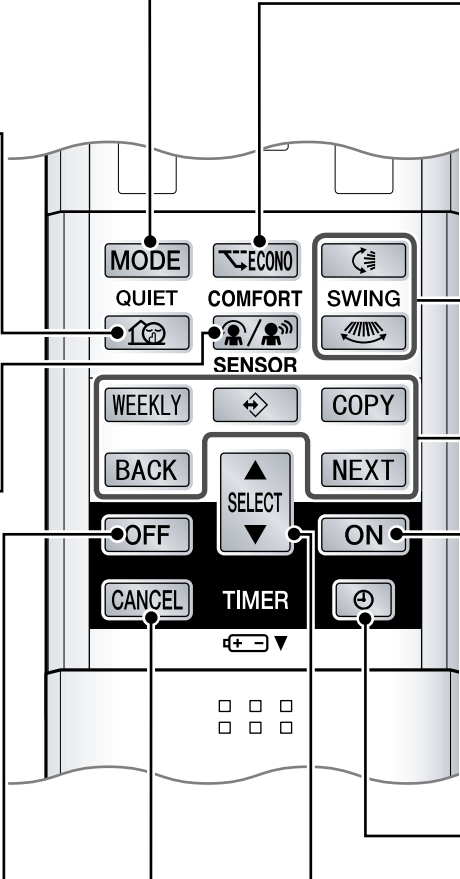

ON TIMER button

- Press this button and adjust the day and time with the **SELECT** button.
- Press this button again to complete **TIMER** setting.

OFF TIMER button

- Press this button and adjust the day and time with the **SELECT** button.
- Press this button again to complete **TIMER** setting.

TIMER CANCEL button

- Cancels the timer setting.
- Cannot be used for the **WEEKLY TIMER** operation.

CLOCK*7 button

SELECT button

- Changes the ON/OFF **TIMER** and **WEEKLY TIMER** settings.

(R21919)

Reference

Refer to the following pages for detail.

★2	COMFORT AIRFLOW operation	P.37, 39
★3	INTELLIGENT EYE operation	P.44
★4	ECONO operation	P.43

★5	Auto-swing	P.36
★6	WEEKLY TIMER operation	P.47
★7	Clock setting	P.46



Note:

Refer to the operation manual of applicable model for detail. You can download operation manuals from Daikin Business Portal:

Daikin Business Portal → Product Information → Operation/Installation Manual
 (URL: https://global1d.daikin.com/business_portal/login/)

2. CDXS, FDXS Series

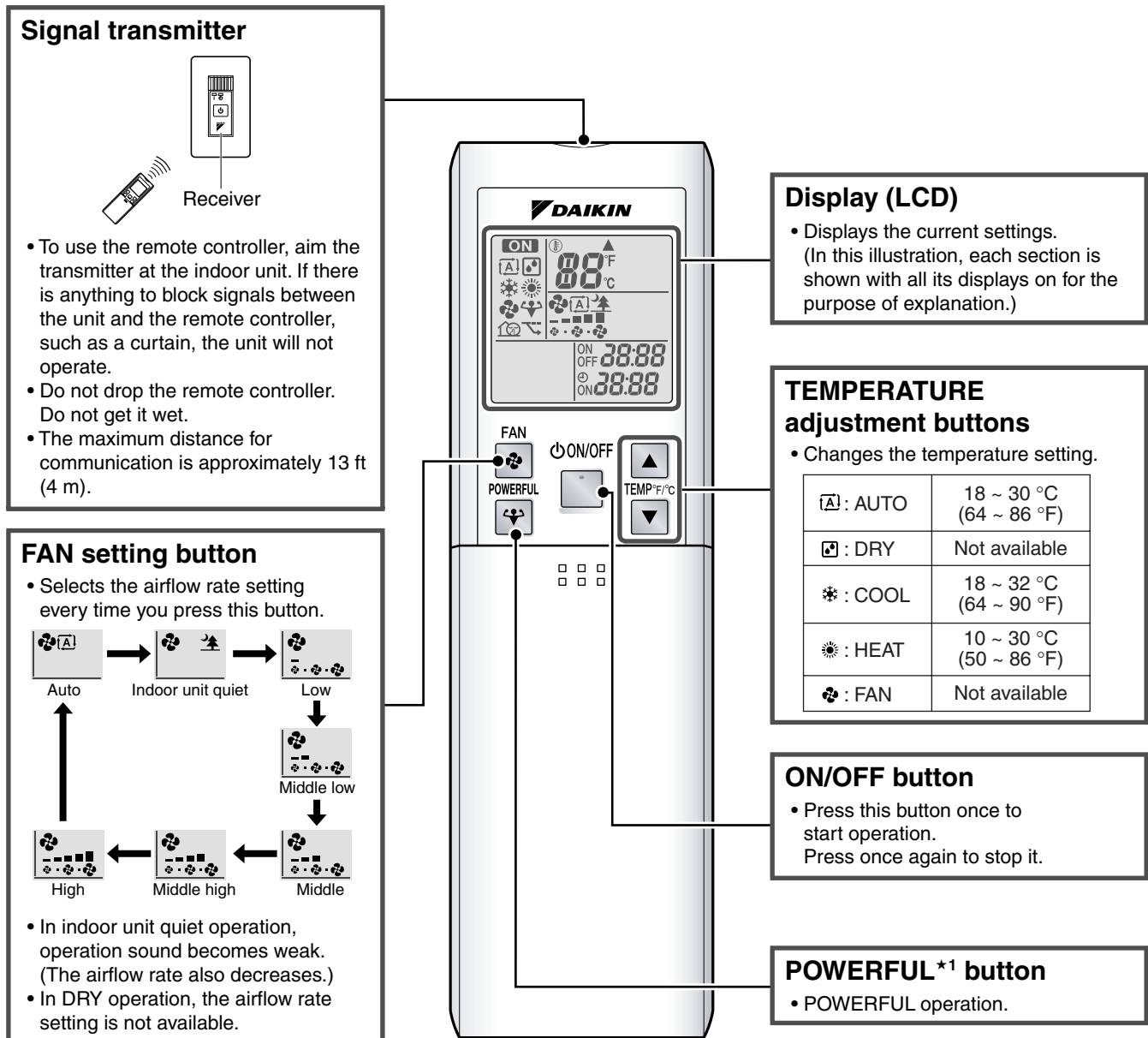

< ARC452A23 >

(R18861)

Reference

Refer to the following pages for detail.

★1	Inverter POWERFUL operation	P.45
----	-----------------------------	------



Note:

Refer to the operation manual of applicable model for detail. You can download operation manuals from Daikin Business Portal:

Daikin Business Portal → Product Information → Operation/Installation Manual

(URL: https://global1d.daikin.com/business_portal/login/)

Open the Front Cover

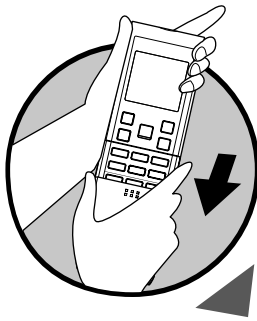

MODE button

- Selects the operation mode.

QUIET button

- OUTDOOR UNIT QUIET operation.
- OUTDOOR UNIT QUIET operation is not available in FAN and DRY operation.
- OUTDOOR UNIT QUIET operation and POWERFUL operation cannot be used at the same time. Priority is given to the function you pressed last.

ECONO*2 button

- ECONO operation.

SELECT button

- Changes the ON/OFF TIMER settings.

OFF TIMER button

- Press this button and adjust the time with the **SELECT** button. Press this button again to complete TIMER setting.

ON TIMER button

- Press this button and adjust the time with the **SELECT** button. Press this button again to complete TIMER setting.

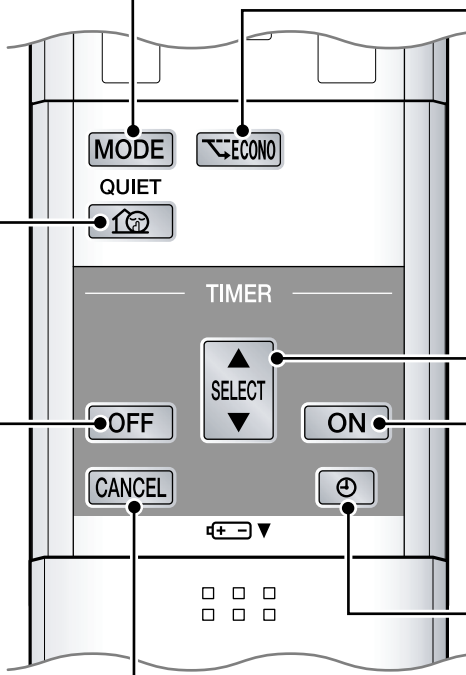

TIMER CANCEL button

- Cancels the timer setting.

CLOCK*3 button

(R21920)

Reference

Refer to the following pages for detail.

★2	ECONO operation	P.43
★3	Clock setting	P.46



Note:

Refer to the operation manual of applicable model for detail. You can download operation manuals from Daikin Business Portal:

Daikin Business Portal → Product Information → Operation/Installation Manual
 (URL: https://global1d.daikin.com/business_portal/login/)

3. FVXS Series

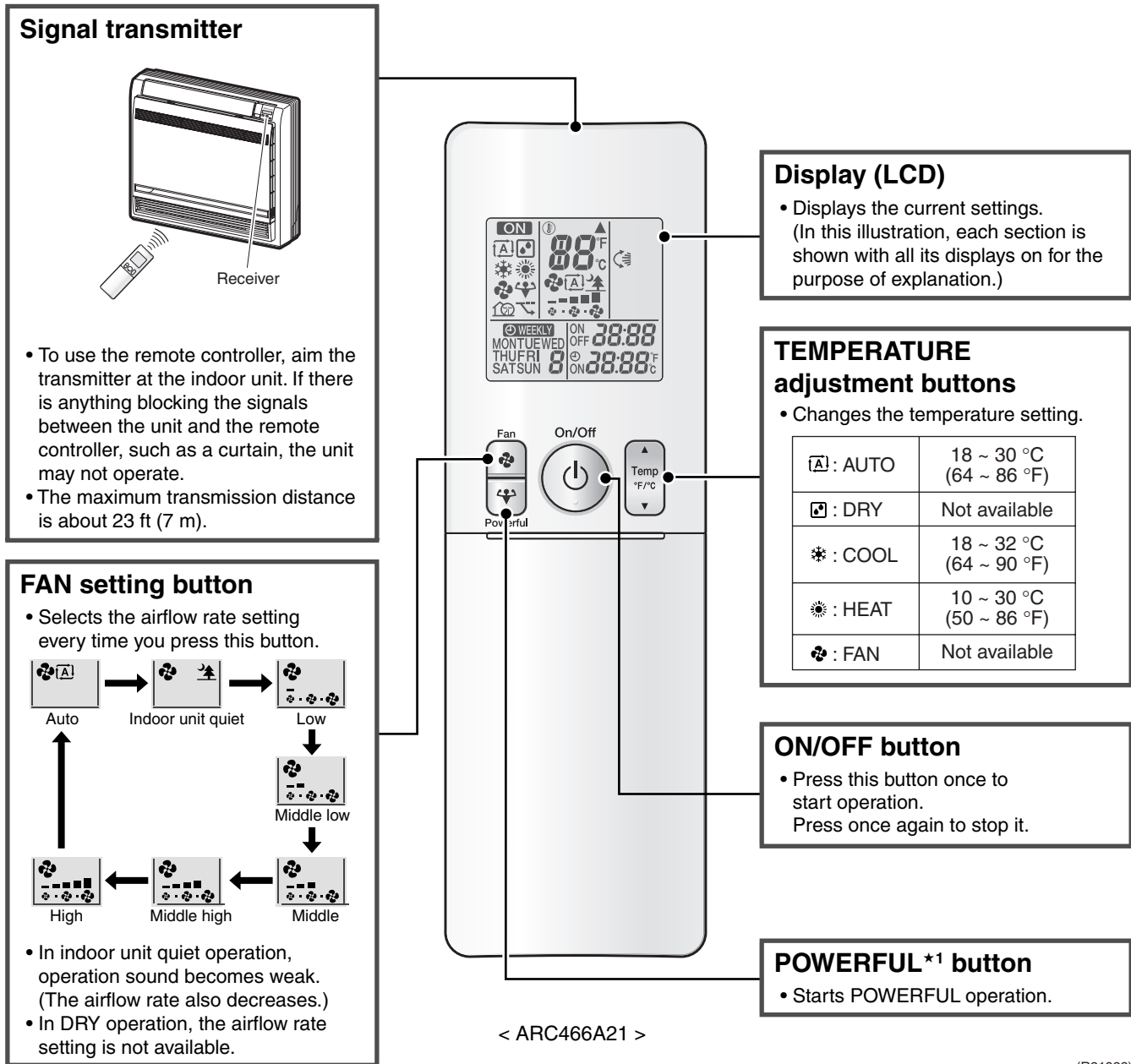

(R21928)

Reference

Refer to the following pages for detail.

★1	Inverter POWERFUL operation	P.45
----	-----------------------------	------



Note: Refer to the operation manual of applicable model for detail. You can download operation manuals from Daikin Business Portal:

Daikin Business Portal → Product Information → Operation/Installation Manual

(URL: https://global1d.daikin.com/business_portal/login/)

Open the Front Cover

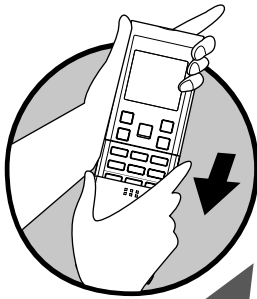

MODE button

• Selects the operation mode.



QUIET button

- OUTDOOR UNIT QUIET operation.
- OUTDOOR UNIT QUIET operation is not available in FAN and DRY operation.
- OUTDOOR UNIT QUIET operation and POWERFUL operation cannot be used at the same time. Priority is given to the function you pressed last.

OFF TIMER button

- Press this button and adjust the day and time with the **SELECT** button. Press this button again to complete TIMER setting.

TIMER CANCEL button

- Cancels the timer setting.
- Cannot be used for the WEEKLY TIMER operation.

ECONO*2 button

• Starts ECONO operation.

SWING*3 button

- Adjusts the airflow direction.
- When you press the **SWING** button, the flap moves up and down. The flap stops when you press the **SWING** button again.

WEEKLY button

- Weekly : **WEEKLY button**
- PROGRAM button
- Copy : **COPY button**
- Back : **BACK button**
- Next : **NEXT button**
- WEEKLY TIMER*4 operation.

ON TIMER button

- Press this button and adjust the day and time with the **SELECT** button. Press this button again to complete TIMER setting.

CLOCK*5 button

SELECT button

• It changes the ON/OFF TIMER and WEEKLY TIMER settings.

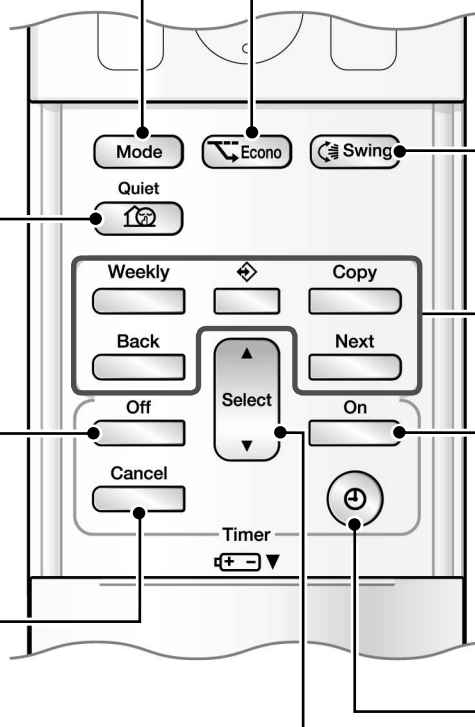

(R21929)

Reference

Refer to the following pages for detail.

★2	ECONO operation	P.43
★3	Auto-swing	P.36

★4	WEEKLY TIMER operation	P.47
★5	Clock setting	P.46



Note: Refer to the operation manual of applicable model for detail. You can download operation manuals from Daikin Business Portal:
 Daikin Business Portal → Product Information → Operation/Installation Manual
 (URL: https://global1d.daikin.com/business_portal/login/)

4. FFQ Series

4.1 <BRC1E71> Wired Remote Controller

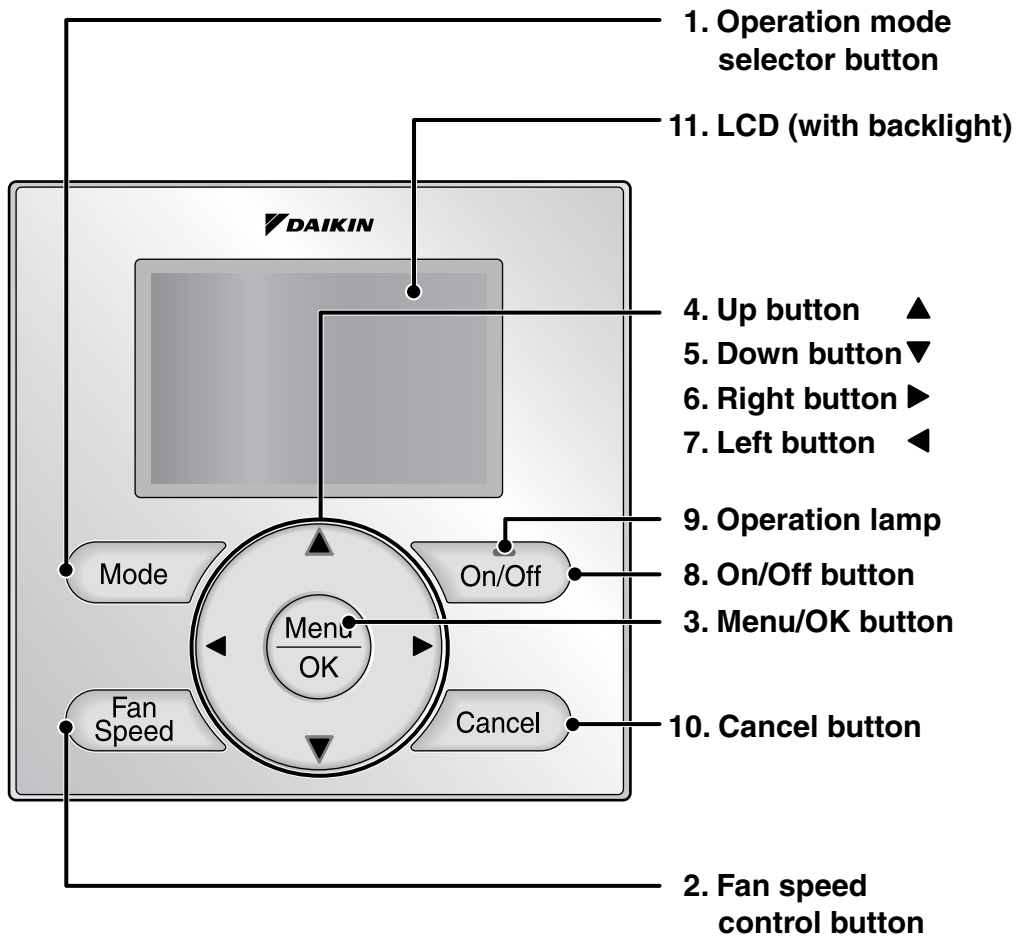

1. Operation mode selector button

- Press this button to select the operation mode of your preference.
* Available modes vary with the indoor unit model.

2. Fan speed control button

- Press this button to select the fan speed of your preference.
* Available fan speeds vary with the indoor unit model.

3. Menu/OK button

- Used to indicate the main menu.
- Used to enter the selected item.

4. Up button ▲

- Used to raise the setpoint.
- The item above the current selection will be highlighted.
(The highlighted items will be scrolled continuously when the button is continuously pressed.)
- Used to change the selected item.

5. Down button ▼

- Used to lower the setpoint.
- The item below the current selection will be highlighted.
(The highlighted items will be scrolled continuously when the button is continuously pressed.)
- Used to change the selected item.

6. Right button ►

- Used to highlight the next items on the right-hand side.
- Each screen is scrolled in the right-hand direction.

7. Left button ◀

- Used to highlight the next items on the left-hand side.
- Each screen is scrolled in the left-hand direction.

8. On/Off button

- Press this button and system will start.
- Press this button again to stop the system.

9. Operation lamp (Green)

- This lamp illuminates solid during normal operation.
- This lamp blinks if a error occurs.

10. Cancel button

- Used to return to the previous screen.

11. LCD (with backlight)

- The backlight will be illuminated for approximately 30 seconds by pressing any button.
- If two remote controllers are used to control a single indoor unit, only the controller to be accessed first will have backlight functionality.

Liquid Crystal Display

- Two types of liquid crystal display (LCD) are available. The standard display is set by default.
- Detailed display can be selected in the main menu.
- The displayed contents of the screen vary with the operation mode of the indoor unit model. (The following display will appear when the indoor unit is in automatic operation.)

Standard display

10. Changeover controlled by the master indoor unit

9. Under centralized control

1. Operation mode → Auto

2. Fan Speed → [Fan speed bar graph]

6. Ventilation → AUTO ERV AIR PURIFY

11. Setback → [SETBACK icon]

8. (⊕) display → [Clock icon]

7. (⊖) display → [Temperature icon]

3. Setpoint display → Set to Cool 74°F Heat 70°F

4. Stand by for Defrost/Hot start → [STANDBY icon]

5. Message → This function is not available

<Standard display example>

Detailed Display

- The air flow direction, clock, and detailed selection items appear on the detailed display screen in addition to the items appearing on the standard display.

12. Air Flow Direction (Displayed only when the air conditioner is in operation.)

13. Current Day/time (12/24 hour time display) → Fri 11:03A

14. Detailed selection → [Detailed selection icon]

<Detailed display example 1>

No Fan speed display (with no fan speed control function)

No Air Flow Direction display (with no air flow direction settings)

No Clock display (when the clock has not been set)

15. (⊗) display → [No clock icon]

No Detailed item display (with no detailed items selected)

<Detailed display example 2>

1. Operation mode

- Used to display the current operation mode: Cool, Heat, Vent, Fan, Dry or Auto.

2. Fan Speed

- Used to display the fan speed that is set for the indoor unit.
- The fan speed will not be displayed if the connected model does not have fan speed control functionality.

3. Setpoint display

- Used to display the setpoint for the indoor unit.
- Use the Celsius/Fahrenheit item in the main menu to select the temperature unit (Celsius or Fahrenheit).

4. Stand by for Defrost/Hot start

“”

If ventilation icon is displayed in this field:

- Indicates that an energy recovery ventilator is connected.
For details, refer to the Operation Manual of the ERV.

5. Message

The following messages may be displayed.

“**This function is not available**”

- Displayed for a few seconds when an operation button is pressed and the indoor unit does not provide the corresponding function.
- In a remote control group, the message will not appear if at least one of the indoor units provides the corresponding function.

“**Error: Push Menu button**”

“**Warning: Push Menu button**”

- Displayed if an error or warning is detected.



“**Time to clean filter**”

“**Time to clean element**”

“**Time to clean filter & element**”

- Displayed as a reminder when it is time to clean the filter or element.

6. Ventilation

- Displayed when a energy recovery ventilator is connected.
- **Ventilation Mode icon.** “ ”
These icons indicate the current ventilation mode (ERV only) (AUTO, ERV, BYPASS).
- **Air Purify ICON** “ ”
This icon indicates that the air purifying unit (option) in operation.

7. display

- Displayed when the key lock is set.

8. display

- Displayed if the Schedule or Off timer is enabled.

9. Under Centralized control “”

- Displayed if the system is under the management of a multi zone controller (option) and the operation of the system through the remote controller is limited.

10. Changeover controlled by the master indoor unit “” (VRV only)

- Displayed when another indoor unit on the system has the authority to change the operation mode between cool and heat.

11. Setback “”

- The setback icon flashes when the unit is turned on under the setback control.

12. Air Flow Direction “”

- Displayed when the air flow direction and swing are set.
- If the connected indoor unit model does not include oscillating louvers this item will not be displayed.

13. Current Day/Time (12/24 hour time display)

- Displayed if the clock is set.
- If the clock is not set, “ -- : -- ” will be displayed.
- 12 hour time format is displayed by default.
- Select 12/24 hour time display option in the main menu under “Clock & Calendar”.

14. Detailed selection

- Displayed if the detailed display item is selected.
- Detailed items are not selected by default.

15. display

- Displayed when the clock needs to be set.
- The schedule function will not work unless the clock is set.

4.2 <BRC1E72/73> Wired Remote Controller

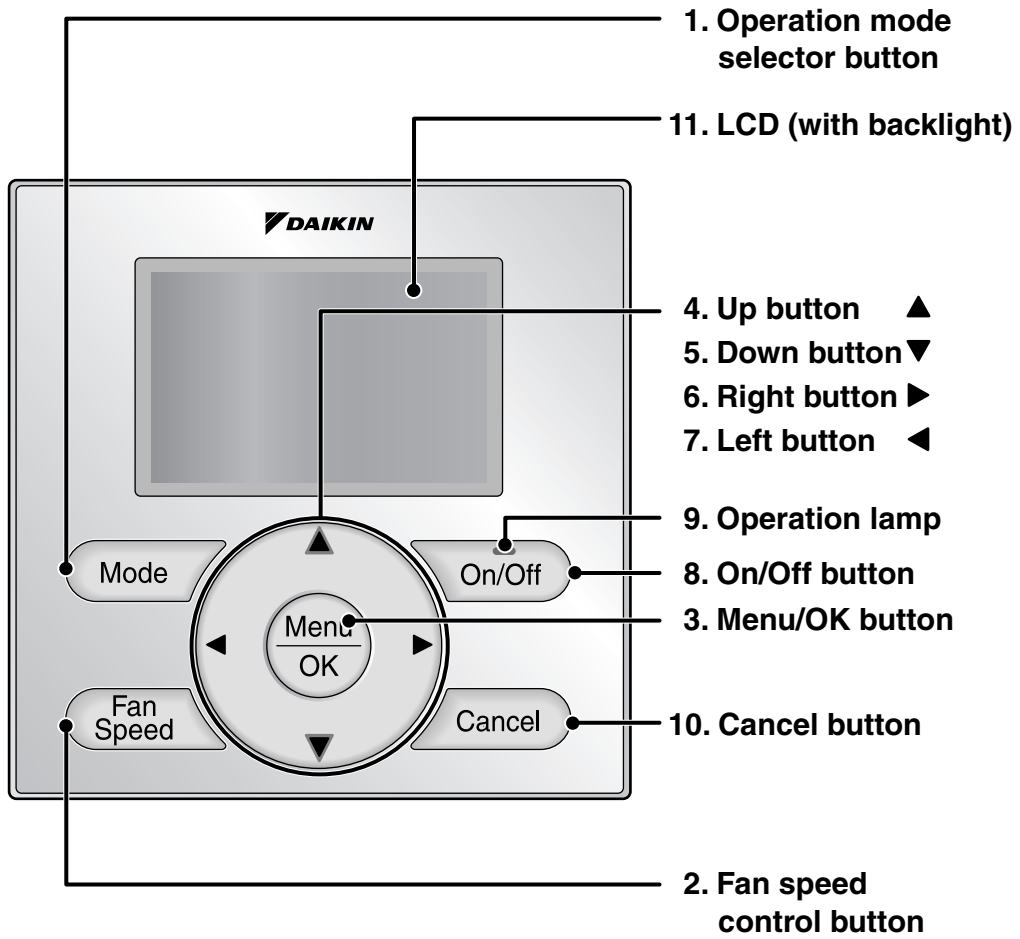

1. Operation mode selector button

- Press this button to select the operation mode of your preference.
* Available modes vary with the indoor unit model.

2. Fan speed control button

- Press this button to select the fan speed of your preference.
* Available fan speeds vary with the indoor unit model.

3. Menu/OK button

- Used to enter the main menu.
- Used to enter the selected item.

4. Up button ▲

- Used to raise the setpoint.
- The item above the current selection will be highlighted.
(The highlighted items will be scrolled continuously when the button is continuously pressed.)
- Used to change the selected item.

5. Down button ▼

- Used to lower the setpoint.
- The item below the current selection will be highlighted.
(The highlighted items will be scrolled continuously when the button is continuously pressed.)
- Used to change the selected item.

6. Right button ►

- Used to highlight the next items on the right-hand side.
- Each screen is scrolled in the right-hand direction.

7. Left button ◀

- Used to highlight the next items on the left-hand side.
- Each screen is scrolled in the left-hand direction.

8. On/Off button

- Press this button and system will start.
- Press this button again to stop the system.

9. Operation lamp

- This lamp illuminates solid green during normal operation.
- This lamp flashes if an error occurs.

10. Cancel button

- Used to return to the previous screen.

11. LCD (with backlight)

- The backlight will be illuminated for approximately 30 seconds by pressing any button.
- If two remote controllers are used to control a single indoor unit, only the controller accessed first will have backlight functionality.

Liquid Crystal Display

- Three types of display mode (Standard, Detailed and Simple) are available.
- Standard display is set by default.
- Detailed and Simple displays can be selected in the main menu.

Standard display

10. Changeover controlled by the master indoor unit

9. Under centralized control

1. Operation mode

2. Fan Speed

6. Ventilation

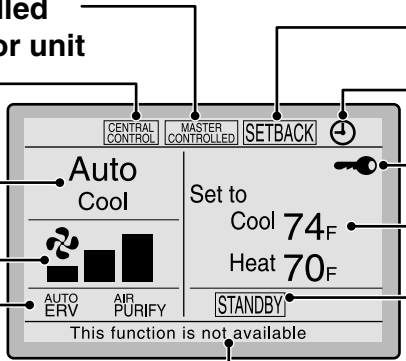

11. Setback

8. (⊕) Scheduled

7. (🔒) Key Lock

3. Setpoint

4. Stand by for Defrost/ Hot start

5. Message

<Standard display example>

Detailed display

- The airflow direction, clock, and selectable item appear on Detailed display screen in addition to the items appearing on Standard display.

12. Airflow Direction (Displayed only when the indoor unit is turned on.)

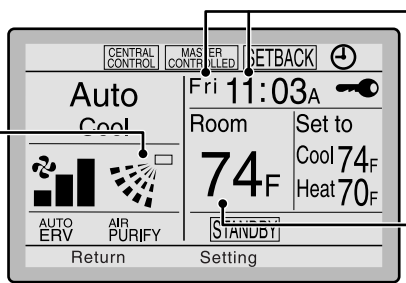

13. Current Day/Time (12/24 hour time display)

14. Selectable Display Item

<Detailed display example 1>

No Fan speed display (with no fan speed control function)

No Airflow Direction display (with no airflow direction settings)

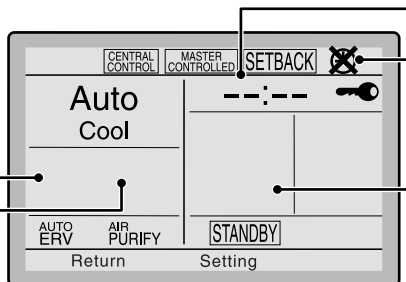

No Clock display (when the clock has not been set yet)

15. (⊗) Unable to schedule

No Selectable Display Item (with no selectable display item selected)

<Detailed display example 2>

Simple display

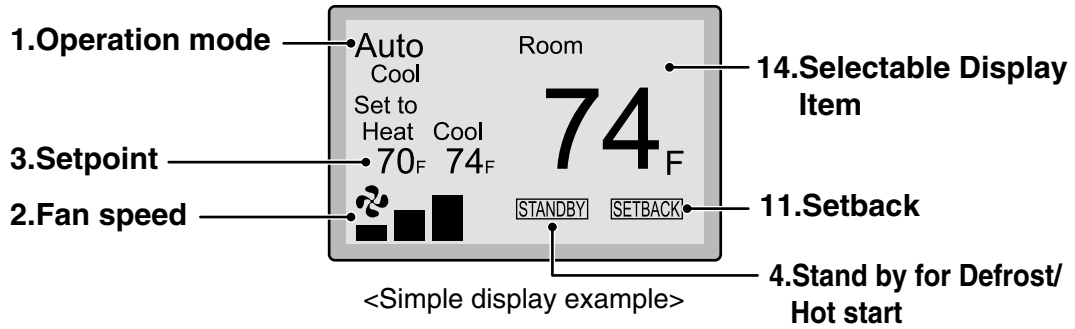

Note for all display modes

- Depending on the field settings, while the indoor unit is stopped, OFF may be displayed instead of the operation mode and/or the setpoint may not be displayed.

1. Operation mode

- Used to display the current operation mode: Cool, Heat, Vent, Fan, Dry or Auto.
- In Auto mode, the actual operation mode (Cool or Heat) will be also displayed.
- Operation mode cannot be changed when OFF is displayed.
Operation mode can be changed after starting operation.

2. Fan Speed

- Used to display the fan speed that is set for the indoor unit.
- The fan speed will not be displayed if the connected model does not have fan speed control functionality.

3. Setpoint

- Used to display the setpoint for the indoor unit.
- Use the Celsius/Fahrenheit item in the main menu to select the temperature unit (Celsius or Fahrenheit).

4. Stand by for Defrost/Hot start

“”

If ventilation icon is displayed in this field:

- Indicates that an energy recovery ventilator (ERV) is connected.
For details, refer to the Operation Manual of the ERV.

5. Message

The following messages may be displayed.

“**This function is not available**”

- Displayed for a few seconds when an Operation button is pressed and the indoor unit does not provide the corresponding function.
- In a remote control group, the message will not appear if at least one of the indoor units provides the corresponding function.

“**Error: Push Menu button**”

“**Warning: Push Menu button**”

- Displayed if an error or warning is detected.



“**Time to clean filter**”

“**Time to clean element**”

“**Time to clean filter & element**”

- Displayed as a reminder when it is time to clean the filter and/or element.

6. Ventilation

- Displayed when an energy recovery ventilator is connected.
- **Ventilation Mode icon.** “ AUTO ERV BYPASS”
These icons indicate the current ventilation mode (ERV only) (AUTO, ERV, BYPASS).
- **Air Purify ICON** “ AIR PURIFY”
This icon indicates that the air purifying unit (Optional) is in operation.

7. Key Lock

- Displayed when the key lock is set.

8. Scheduled

- Displayed if the Schedule or Off timer is enabled.

9. Under Centralized control “”

- Displayed if the system is under the management of a multi-zone controller (Optional) and the operation of the system through the remote controller is limited.

10. Changeover controlled by the master indoor unit “” (VRV only)

- Displayed when another indoor unit on the system has the authority to change the operation mode between cool and heat.

11. Setback “”

- The setback icon flashes when the unit is turned on by the setback control.

12. Airflow Direction “”

- Displayed when the airflow direction and swing are set.
- If the connected indoor unit model does not include oscillating louvers this item will not be displayed.

13. Current Day/Time (12/24 hour time display)

- Displayed if the clock is set.
- If the clock is not set, “ -- : -- ” will be displayed.
- 12 hour time format is displayed by default.
- Select 12/24 hour time display option in the main menu under “Clock & Calendar”.

14. Selectable Display Item

- Room temperature is selected by default.
- For other choices see the operation manual.

15. ~~Unable~~ Unable to schedule

- Displayed when the clock needs to be set.
- The schedule function will not work unless the clock is set.

4.3 <BRC7E830> Wireless Remote Controller

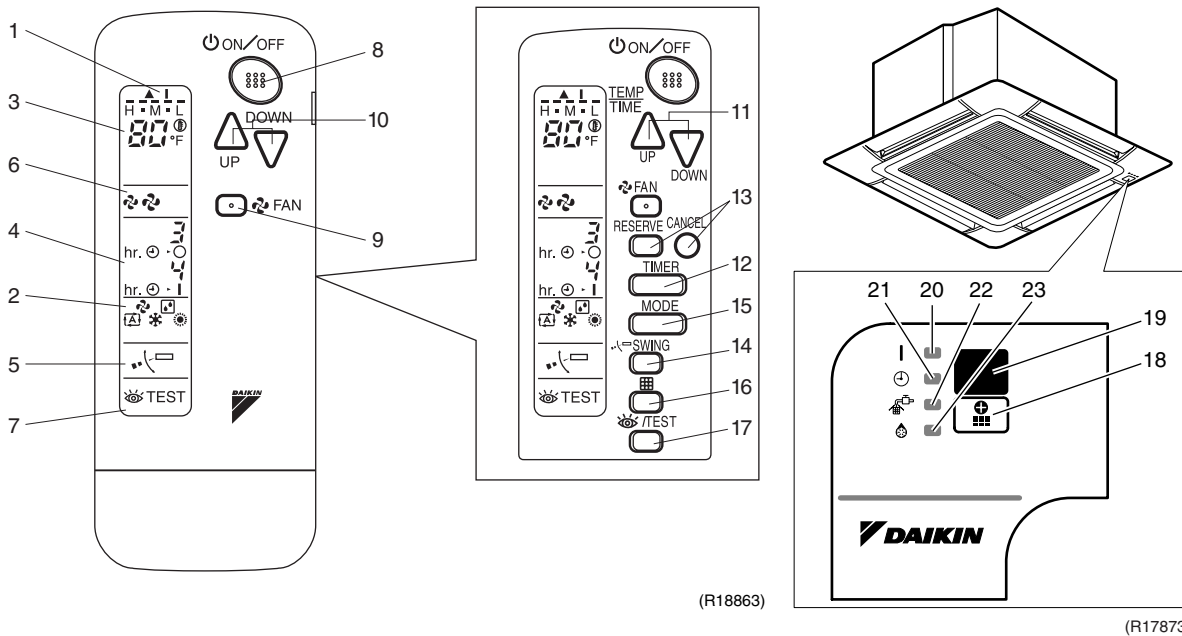

(R18863)

(R17873)

	DISPLAY ▲ (SIGNAL TRANSMISSION)
1	This lights up when a signal is being transmitted.
	DISPLAY , , , , (OPERATION MODE)
2	This display shows the current operation mode.
	DISPLAY (SET TEMPERATURE)
3	This display shows the set temperature.
	DISPLAY hr. ⓪ 3 hr. ⓪ 4 (PROGRAMMED TIME)
4	This display shows programmed time of the system start or stop.
	DISPLAY (AIRFLOW FLAP)
5	
	DISPLAY (FAN SPEED)
6	The display shows the set fan speed.
	DISPLAY TEST (INSPECTION/ TEST OPERATION)
7	When the INSPECTION/TEST button is pressed, the display shows the system mode is in.
	ON/OFF BUTTON
8	Press the button and the system will start. Press the button again and the system will stop.
	FAN BUTTON
9	Press this button to select the fan speed, HIGH or LOW, of your choice.
	TEMPERATURE SETTING BUTTON
10	Use this button for setting temperature (Operates with the front cover of the remote controller closed.)

	PROGRAMMING TIMER BUTTON
11	Use this button for programming start and/or stop time. (Operates with the front cover of the remote controller opened.)
	TIMER MODE START/STOP BUTTON
12	
	TIMER RESERVE/CANCEL BUTTON
13	
	SWING BUTTON
14	
	OPERATION MODE SELECTOR BUTTON
15	Press this button to select operation mode.
	FILTER SIGN RESET BUTTON
16	
	INSPECTION/TEST BUTTON
17	This button is used only by qualified service persons for maintenance purposes.
	EMERGENCY OPERATION SWITCH
18	This switch is readily used if the remote controller does not work.
	RECEIVER
19	This receives the signals from the remote controller.
	OPERATING INDICATOR LAMP (Red)
20	This lamp stays lit while the air conditioner runs. It flashes when the unit is in trouble.
	TIMER INDICATOR LAMP (Green)
21	This lamp stays lit while the timer is set.
	AIR FILTER CLEANING TIME INDICATOR LAMP (Red)
22	Lights up when it is time to clean the air filter.
	DEFROST LAMP (Orange)
23	Lights up when the defrosting operation has started.

Part 6

Service Diagnosis

1. General Problem Symptoms and Check Items	99
2. Troubleshooting with LED	100
2.1 Indoor Unit.....	100
2.2 Outdoor Unit.....	101
3. Service Diagnosis	102
3.1 CTXS, FTXS, CDXS, FDXS, FVXS Series	102
3.2 FFQ Series	108
4. Code Indication on Remote Controller	114
4.1 CTXS, FTXS, CDXS, FDXS, FVXS Series	114
4.2 FFQ Series	114
4.3 Outdoor Unit.....	115
5. Troubleshooting for CTXS, FTXS, CDXS, FDXS, FVXS Series	116
5.1 Indoor Unit PCB Abnormality	116
5.2 Freeze-up Protection Control / Heating Peak-cut Control	118
5.3 Fan Motor or Related Abnormality	119
5.4 Thermistor or Related Abnormality.....	123
5.5 Signal Transmission Error (Between Indoor Unit and Outdoor Unit).....	124
5.6 Unspecified Voltage (Between Indoor Unit and Outdoor Unit)	126
6. Troubleshooting for FFQ Series	127
6.1 Indoor Unit PCB Abnormality	127
6.2 Drain Level Control System Abnormality.....	128
6.3 Fan Motor (AC Motor) or Related Abnormality	129
6.4 Drain System Abnormality.....	130
6.5 Thermistor or Related Abnormality.....	131
6.6 Remote Controller Thermistor Abnormality	132
6.7 Signal Transmission Error (Between Indoor Unit and Remote Controller)	133
6.8 Signal Transmission Error (Between MAIN Remote Controller and SUB Remote Controller)	134
6.9 Field Setting Abnormality	135
7. Troubleshooting for Outdoor Unit.....	136
7.1 Refrigerant Shortage	136
7.2 Low-voltage Detection or Over-voltage Detection.....	138
7.3 Wiring Error Check Unexecuted.....	140
7.4 Unspecified Voltage (Between Indoor Unit and Outdoor Unit) / Anti-icing Control in Other Rooms.....	141
7.5 Anti-icing Control for Indoor Unit	142
7.6 Outdoor Unit PCB Abnormality.....	144
7.7 OL Activation (Compressor Overload)	145
7.8 Compressor Lock	147
7.9 DC Fan Lock	148

7.10	Input Overcurrent Detection	149
7.11	Four Way Valve Abnormality	150
7.12	Discharge Pipe Temperature Control	152
7.13	High Pressure Control in Cooling	153
7.14	Compressor Sensor System Abnormality	154
7.15	Position Sensor Abnormality	156
7.16	CT or Related Abnormality	158
7.17	Thermistor or Related Abnormality (Outdoor Unit)	160
7.18	Electrical Box Temperature Rise	162
7.19	Radiation Fin Temperature Rise	163
7.20	Output Overcurrent Detection	164
8.	Check	166
8.1	Thermistor Resistance Check	166
8.2	Indoor Fan Motor Connector Check	167
8.3	Hall IC Check	167
8.4	Power Supply Waveform Check	168
8.5	Electronic Expansion Valve Check	169
8.6	Four Way Valve Performance Check	170
8.7	Inverter Unit Refrigerant System Check	170
8.8	Inverter Analyzer Check	171
8.9	Rotation Pulse Check on the Outdoor Unit PCB	172
8.10	Installation Condition Check	173
8.11	Discharge Pressure Check	173
8.12	Outdoor Fan System Check	174
8.13	Main Circuit Short Check	174
8.14	Capacitor Voltage Check	175
8.15	Power Module Check	176

1. General Problem Symptoms and Check Items

Problem Symptom	Check Item	Details	Reference Page
None of the units operates.	Check the power supply.	Check if the rated voltage is supplied.	—
	Check the types of the indoor units.	Check if the indoor unit type is compatible with the outdoor unit.	—
	Check the outdoor temperature.	Heating operation cannot be used when the outdoor temperature is 15.5°CWB (59.9°FWB) or higher, and cooling operation cannot be used when the outdoor temperature is below -10°CDB (14°FDB).	—
	Diagnose with remote controller indication	—	114, 115
	Check the remote controller addresses.	Check if address settings for the remote controller and indoor unit are correct.	189
Operation sometimes stops.	Check the power supply.	A power failure of 2 to 10 cycles can stop air conditioner operation. (Operation lamp OFF)	—
	Check the outdoor temperature.	Heating operation cannot be used when the outdoor temperature is 15.5°CWB (59.9°FWB) or higher, and cooling operation cannot be used when the outdoor temperature is below -10°CDB (14°FDB).	—
	Diagnose with remote controller indication.	—	114, 115
Some indoor units do not operate.	Check the type of the indoor units.	Check if the indoor unit type is compatible with the outdoor unit.	—
	Diagnose with remote controller indication	—	114, 115
Units operate but do not cool, or do not heat.	Check for wiring and piping errors in the connection between the indoor and outdoor units.	Check the piping. Conduct the wiring error check described on the product diagnosis nameplate.	—
	Check for thermistor detection errors.	Check if the thermistor is mounted securely.	—
	Check for faulty operation of the electronic expansion valve.	Set all the units to cooling operation, and compare the temperatures of the liquid pipes to see if the each electronic expansion valve works.	—
	Diagnose with remote controller indication.	—	114, 115
	Diagnose by service port pressure and operating current.	Check for refrigerant shortage.	136
Large operating noise and vibrations	Check the output voltage of the power module.	—	176
	Check the power module.	—	—
	Check the installation condition.	Check if the required spaces for installation (specified in the installation manual) are provided.	—

2. Troubleshooting with LED

2.1 Indoor Unit

Operation Lamp

The operation lamp blinks when any of the following errors is detected.

1. When a protection device of the indoor or outdoor unit is activated, or when the thermistor malfunctions.
 2. When a signal transmission error occurs between the indoor and outdoor units.
- In either case, conduct the diagnostic procedure described in the following pages.

CTXS/FTXS series

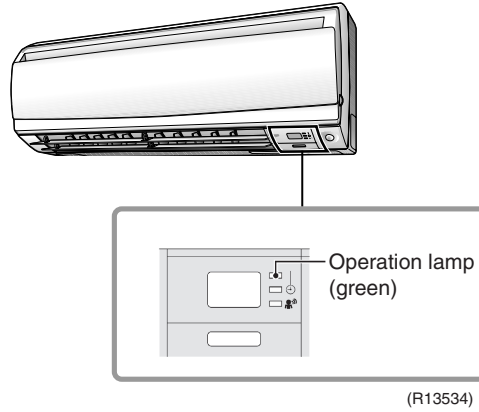

CDXS/FDXS series

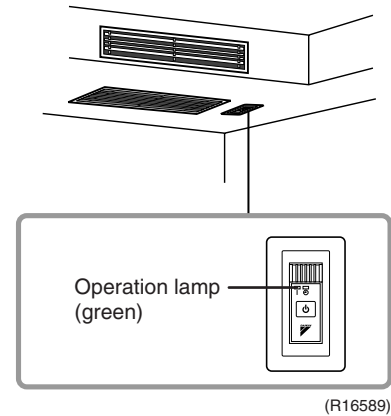

FVXS series

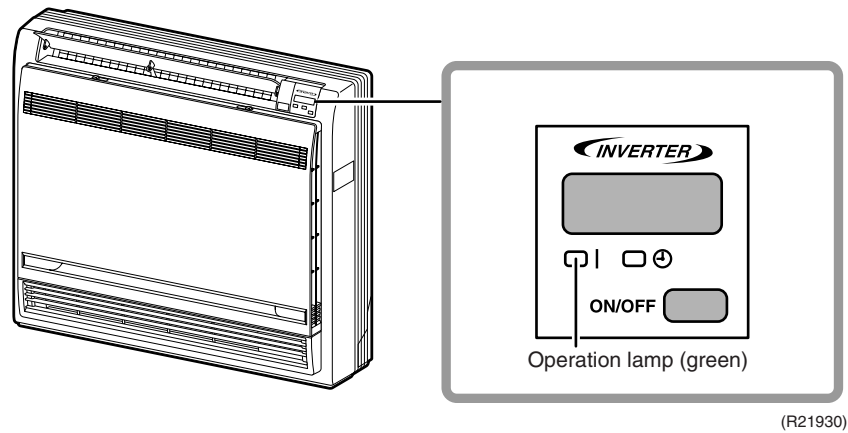

BRC1E71/72/73

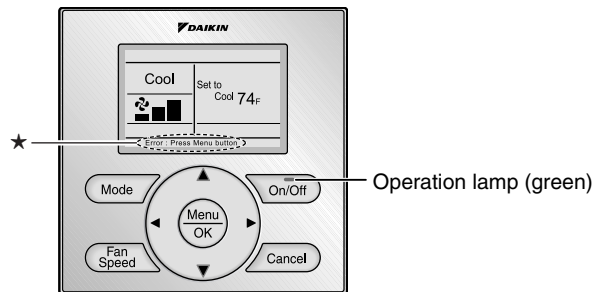

★The error or warning message also blinks on the basic screen. (R18816)

BRC7E830

In case of wireless remote controller, a signal receiver PCB and a display PCB are installed on indoor unit. When the error occurs, the operation lamp on the display PCB blinks.



- Caution:** When operation stops suddenly and the operation lamp blinks, it could be operation mode conflict.
- 1) Check if the operation modes all the same for the indoor units connected to multi system outdoor unit?
 - 2) If not, set all the indoor units to the same operation mode and confirm that the operation lamp is not blinking.
 - 3) Moreover, when the operation mode is automatic, set all the indoor unit operation mode as cooling or heating and check again if the operation lamp is normal.
- If the lamp stops blinking after the above steps, there is no malfunction.

*Operation stops and operation lamp blinks only for the indoor unit that has a different operation mode set later. (The first set operation mode has priority.)

Service Monitor

The indoor unit has a green LED (LED A or HAP) on the control PCB. When the microcomputer works in order, the LED blinks. (Refer to page 18, 20, 22, 24, 26 for the location of LED.)

2.2 Outdoor Unit

The outdoor unit has a green LED (LED A) and red LEDs (LED 1 ~ LED 5) on the PCB. When the microcomputer works in order, the LED A blinks, and when the system is in normal condition, the red LEDs are OFF.

Even after the error is canceled and the unit operates in normal condition, the LED indication remains.

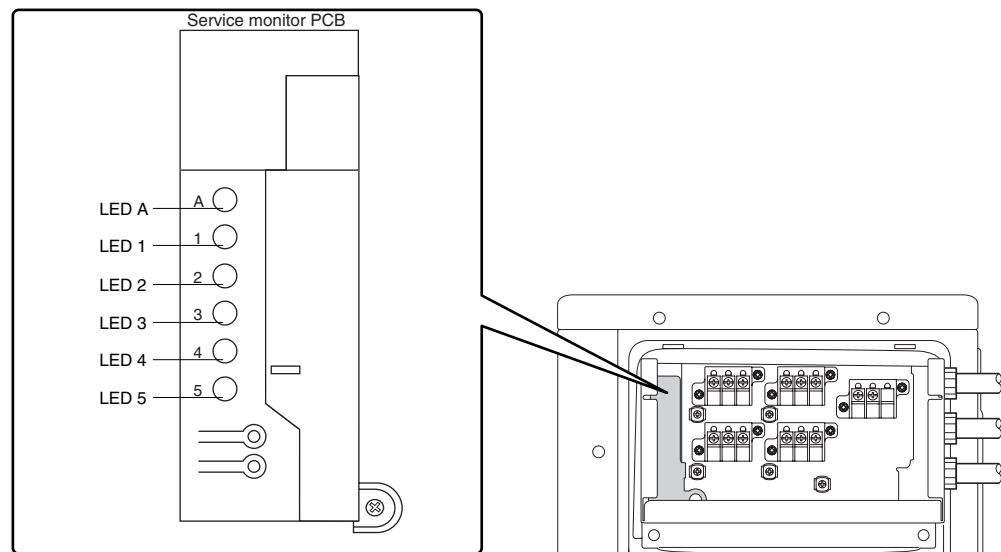

(R21921)

3. Service Diagnosis

3.1 CTXS, FTXS, CDXS, FDXS, FVXS Series

3.1.1 ARC452 Series Remote Controller

Method 1

- When the timer cancel button is held down for 5 seconds,  is displayed on the temperature display screen.

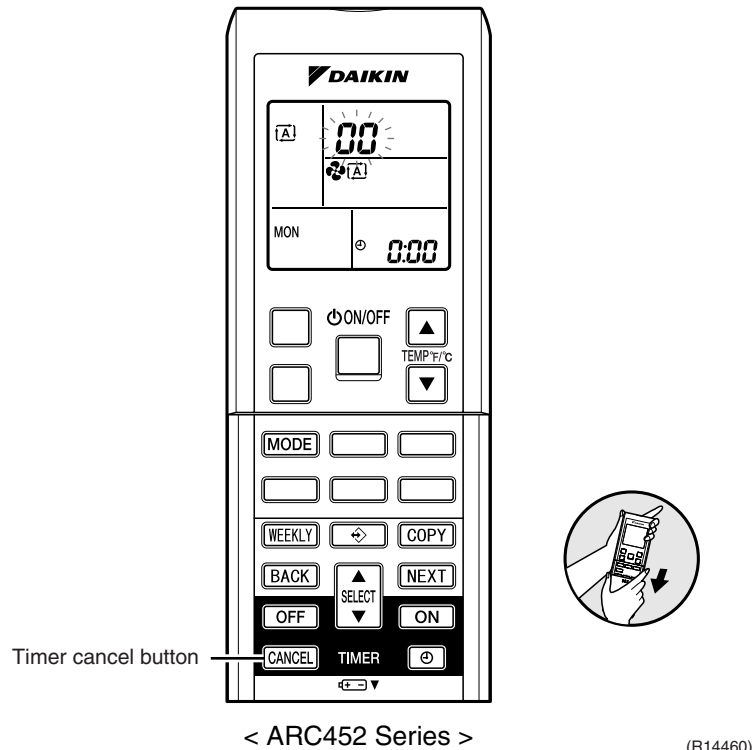

- Press the timer cancel button repeatedly until a long beep sounds.
 - The code indication changes in the sequence shown below.

No.	Code	No.	Code	No.	Code
1	00	13	E7	25	UR
2	U4	14	R3	26	UH
3	L5	15	H8	27	P4
4	E6	16	H9	28	L3
5	H6	17	E9	29	L4
6	H0	18	E4	30	H7
7	R6	19	E5	31	U2
8	E7	20	J3	32	ER
9	U0	21	J6	33	RH
10	F3	22	E5	34	FR
11	R5	23	R1	35	H1
12	F6	24	E1	36	P9



Note:

- A short beep or two consecutive beeps indicate non-corresponding codes.
- To return to the normal mode, hold the timer cancel button down for 5 seconds. When the remote controller is left untouched for 60 seconds, it also returns to the normal mode.
- Not all the error codes are displayed. When you cannot find the error code, try method 2. (→ Refer to page 103.)

Method 2

1. Press the 3 buttons (**TEMP▲**, **TEMP▼**, **MODE**) at the same time to enter the diagnosis mode.

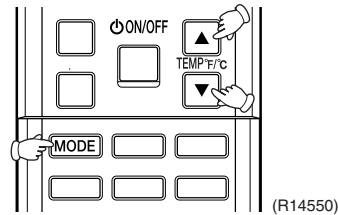

The left-side number blinks.

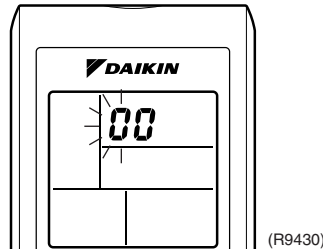

2. Press the **TEMP ▲** or **TEMP ▼** button and change the number until you hear the two consecutive beeps or the long beep.

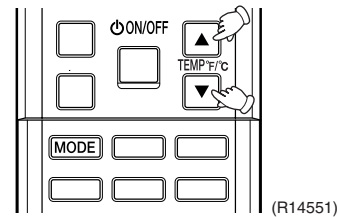

3. Diagnose by the sound.
 - ★beep : The left-side number does not correspond with the error code.
 - ★two consecutive beeps : The left-side number corresponds with the error code but the right-side number does not.
 - ★long beep : Both the left-side and right-side number correspond with the error code. The numbers indicated when you hear the long beep are the error code. Refer to page 114, 115.

4. Press the **MODE** button.

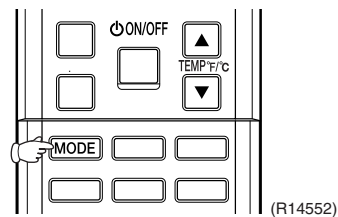

The right-side number blinks.

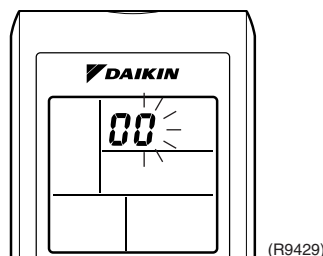

5. Press the **TEMP ▲** or **TEMP ▼** button and change the number until you hear the long beep.

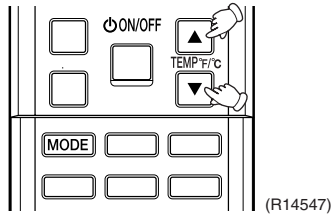

6. Diagnose by the sound.
- ★beep : The left-side number does not correspond with the error code.
 - ★two consecutive beeps : The left-side number corresponds with the error code but the right-side number does not.
 - ★long beep : Both the left-side and right-side number corresponds with the error code.
7. Determine the error code.
The numbers indicated when you hear the long beep are the error code.
Refer to page 114, 115.

8. Press the **MODE** button to exit from the diagnosis mode.

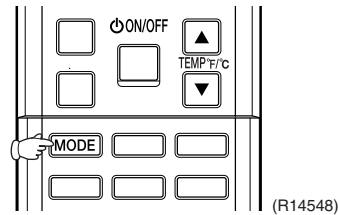

The display **7⁻** means the trial operation mode.
Refer to page 181 for trial operation.

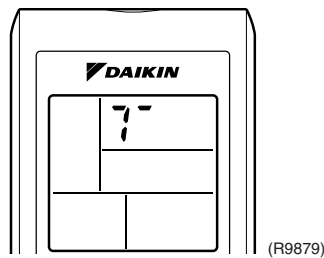

9. Press the **ON/OFF** button twice to return to the normal mode.

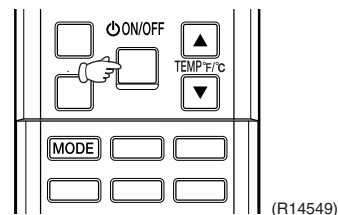

Note: When the remote controller is left untouched for 60 seconds, it returns to the normal mode.

3.1.2 ARC466 Series Remote Controller

Method 1

1. When the timer cancel button is held down for 5 seconds,  is displayed on the temperature display screen.

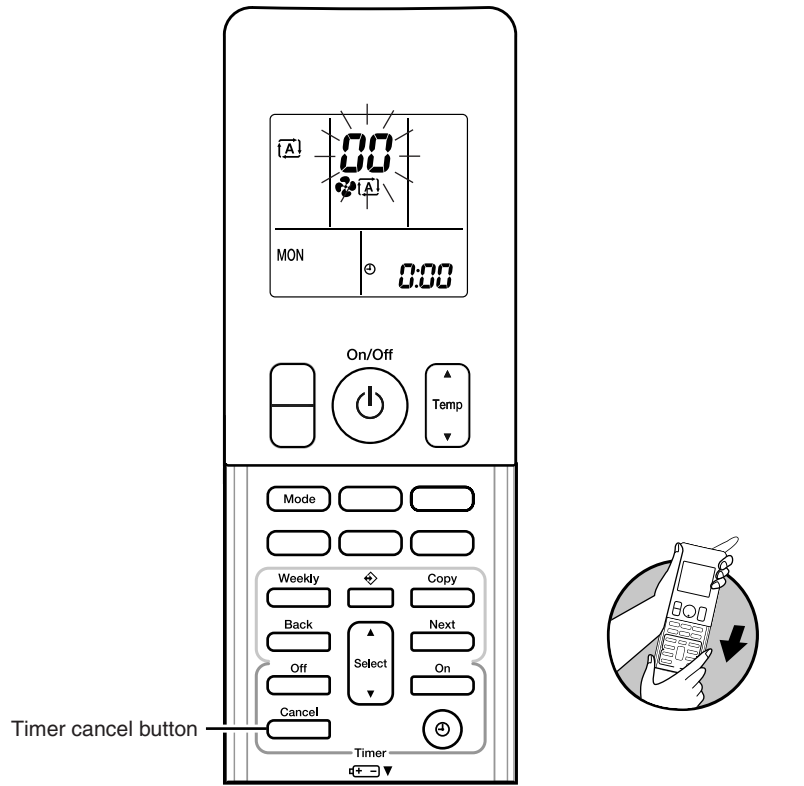

< ARC466 Series >

(R21282)

2. Press the timer cancel button repeatedly until a long beep sounds.
 - The code indication changes in the sequence shown below.

No.	Code	No.	Code	No.	Code
1	00	14	UD	27	UR
2	RS	15	U7	28	UR
3	E7	16	R3	29	P4
4	F3	17	MB	30	M7
5	F6	18	M9	31	U2
6	L3	19	C9	32	ER
7	L4	20	C4	33	RR
8	L5	21	C5	34	FR
9	U4	22	J3	35	H1
10	E6	23	U6	36	P9
11	M6	24	E5	37	E3
12	M0	25	R1	38	M3
13	R6	26	E1		



Note:

1. A short beep or two consecutive beeps indicate non-corresponding codes.
2. To return to the normal mode, hold the timer cancel button down for 5 seconds. When the remote controller is left untouched for 60 seconds, it also returns to the normal mode.
3. Not all the error codes are displayed. When you cannot find the error code, try method 2. (→ Refer to page 106.)

Method 2

1. Press the center of the **Temp** button and the **Mode** button at the same time.

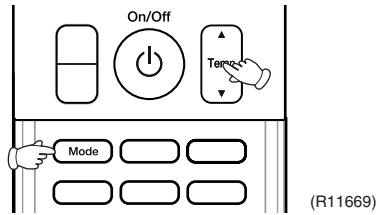

5C is displayed on the LCD.

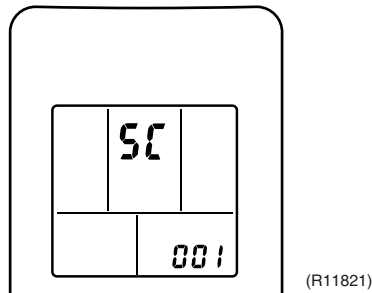

2. Select 5C (service check) with the **Temp ▲** or **Temp ▼** button.
3. Press the **Mode** button to enter the service check mode.

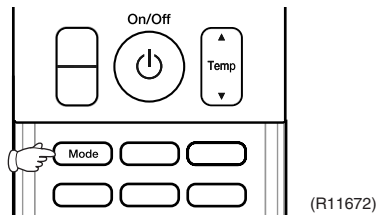

The left-side number blinks.

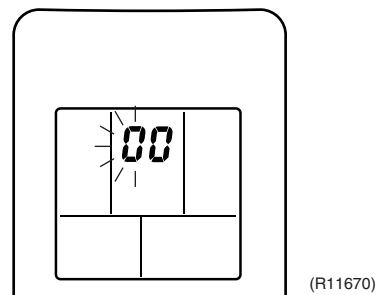

4. Press the **Temp ▲** or **Temp ▼** button and change the number until you hear the two consecutive beeps or the long beep.

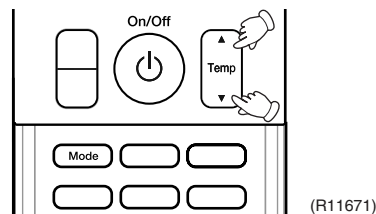

5. Diagnose by the sound.
 - ★ beep: The left-side number does not correspond with the error code.
 - ★ two consecutive beeps: The left-side number corresponds with the error code but the right-side number does not.
 - ★ long beep: Both the left-side and right-side numbers correspond with the error code.
The numbers indicated when you hear the long beep are the error code.
Refer to page 114, 115.

6. Press the **Mode** button.

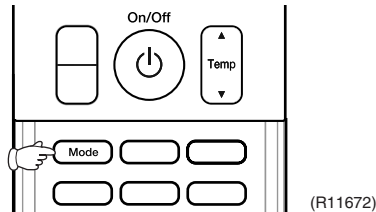

The right-side number blinks.

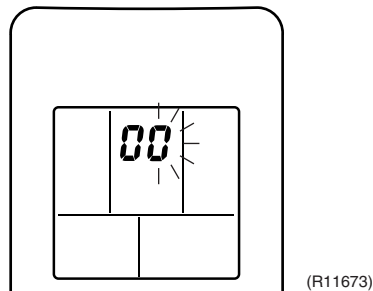

7. Press the **Temp ▲** or **Temp ▼** button and change the number until you hear the long beep.

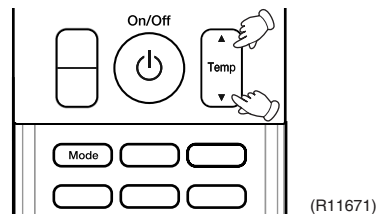

8. Diagnose by the sound.
 - ★ beep: The left-side number does not correspond with the error code.
 - ★ two consecutive beeps: The left-side number corresponds with the error code but the right-side number does not.
 - ★ long beep: Both the left-side and right-side numbers correspond with the error code.
9. Determine the error code.
The numbers indicated when you hear the long beep are the error code.
Refer to page 114, 115.
10. Press the **Mode** button for 5 seconds to exit from the service check mode.
(When the remote controller is left untouched for 60 seconds, it returns to the normal mode also.)

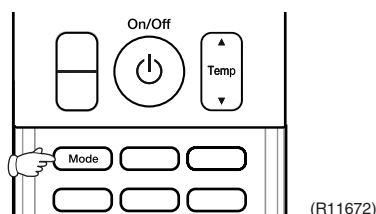

3.2 FFQ Series

3.2.1 BRC1E71/72/73

Note: The illustrations are for BRC1E72 as representative.

Relations Between Modes

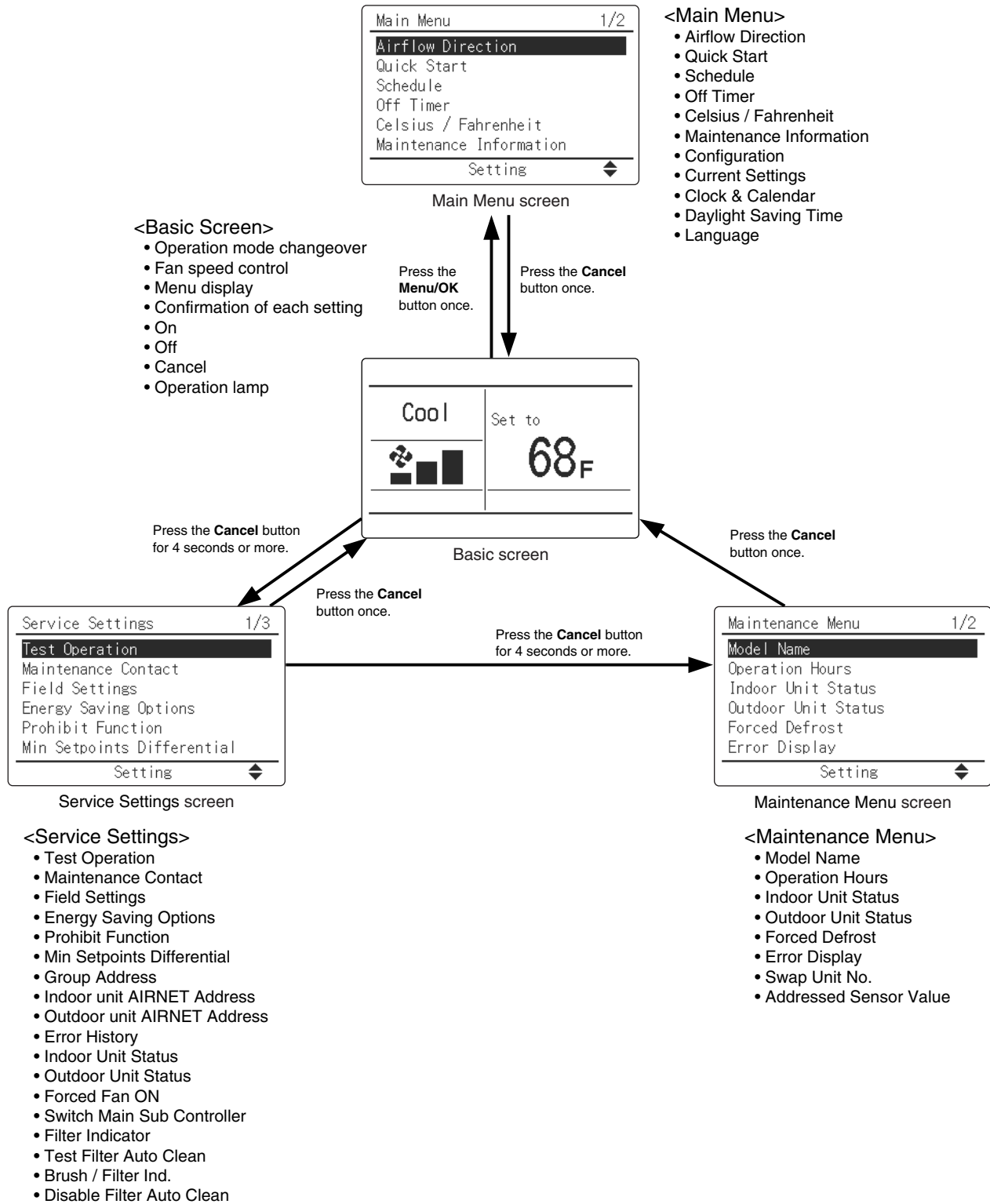

Service Check Function

The following message is displayed on the screen when a error (or a warning) occurs during operation. Check the error code and take the corrective action specified for the particular model.

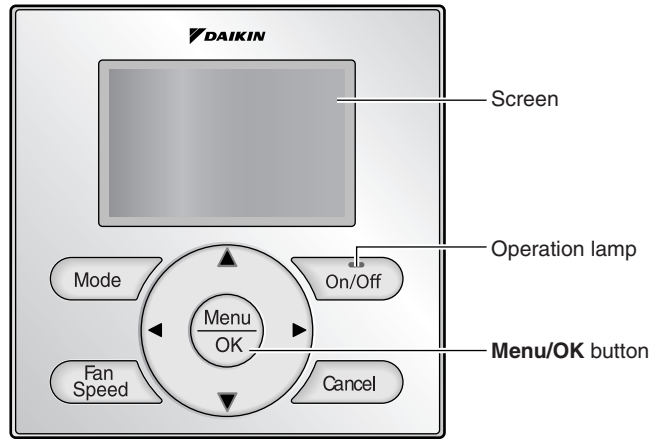

(R18817)

(1) Check if it is error or warning.

	Operation status		Display
Abnormal shutdown	The system stops operating.	The operation lamp (green) starts to blink. The message Error: Push Menu button blinks at the bottom of the screen.	<p>(R18971)</p>
Warning	The system continues its operation.	The operation lamp (green) remains on. The message Warning: Push Menu button blinks at the bottom of the screen.	<p>(R18972)</p>

(2) Take corrective action.

- Press the **Menu/OK** button to check the error code.



- Take the corrective action specific to the model.

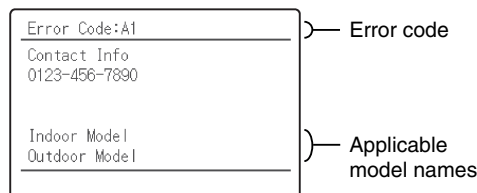

(R18820)

3.2.2 BRC7E830

Relations Between Modes

The following modes can be selected by using the **INSPECTION/TEST** button on the remote controller.

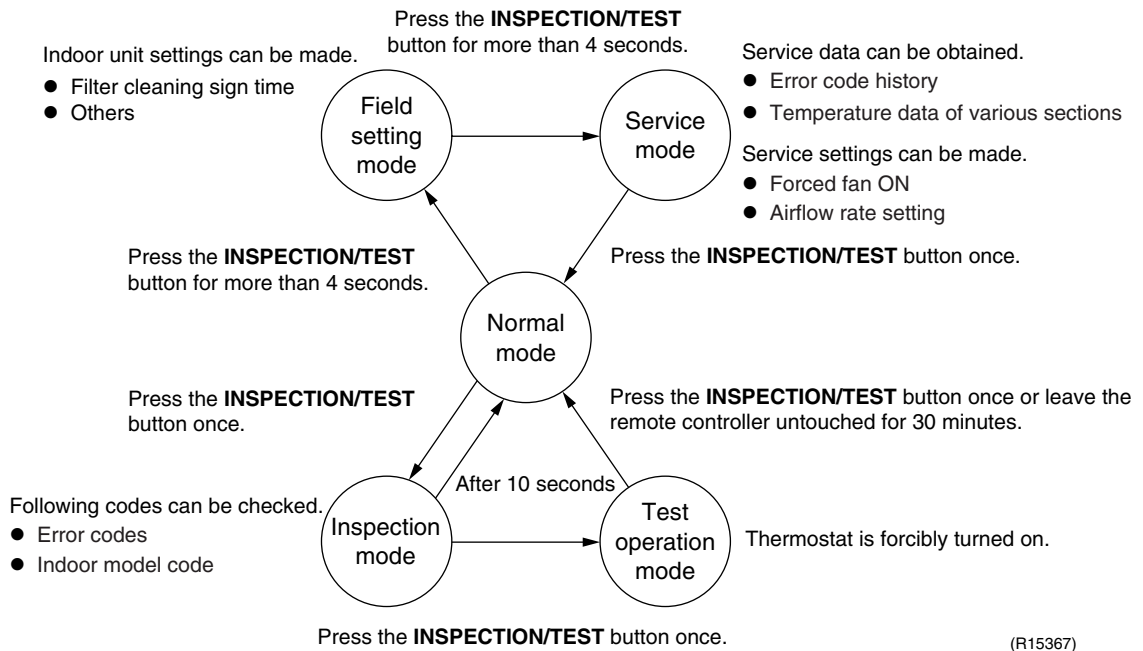

Service Check Function

To find the error code, proceed as follows:

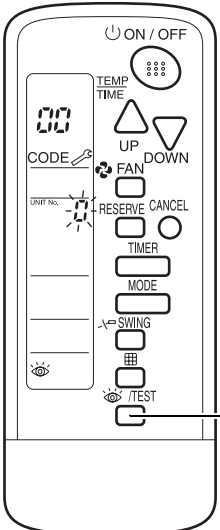
Step	Action
1	<p>Press the INSPECTION/TEST button to enter the inspection mode. Then the figure  blinks on the UNIT No. display.</p>  <p style="text-align: right;">INSPECTION/TEST button</p> <p style="text-align: right;">(R14392)</p>

Step	Action								
<p>2</p>	<p>Press the UP or DOWN button and change the UNIT No. until the receiver of the remote controller starts to beep.</p> <div data-bbox="743 308 1274 846" style="text-align: center;"> </div> <p style="text-align: right;">(R15408)</p> <table border="1" data-bbox="630 921 1388 1166" style="width: 100%; border-collapse: collapse;"> <thead> <tr> <th style="text-align: left;">If you hear...</th> <th style="text-align: left;">Then...</th> </tr> </thead> <tbody> <tr> <td>3 short beeps</td> <td>Follow all steps below.</td> </tr> <tr> <td>1 short beep</td> <td>Follow steps 3 and 4. Continue the operation in step 4 until you hear a continuous beep. This continuous beep indicates that the error code is confirmed.</td> </tr> <tr> <td>1 continuous beep</td> <td>There is no abnormality.</td> </tr> </tbody> </table>	If you hear...	Then...	3 short beeps	Follow all steps below.	1 short beep	Follow steps 3 and 4. Continue the operation in step 4 until you hear a continuous beep. This continuous beep indicates that the error code is confirmed.	1 continuous beep	There is no abnormality.
If you hear...	Then...								
3 short beeps	Follow all steps below.								
1 short beep	Follow steps 3 and 4. Continue the operation in step 4 until you hear a continuous beep. This continuous beep indicates that the error code is confirmed.								
1 continuous beep	There is no abnormality.								
<p>3</p>	<p>Press the MODE button. The left (upper digit) indication of the error code blinks.</p> <div data-bbox="760 1244 1258 1783" style="text-align: center;"> </div> <p style="text-align: right;">(R15410)</p>								

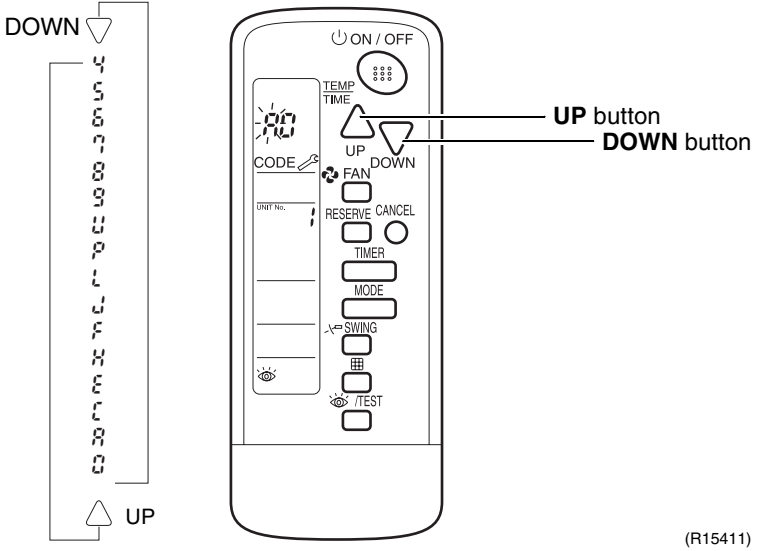
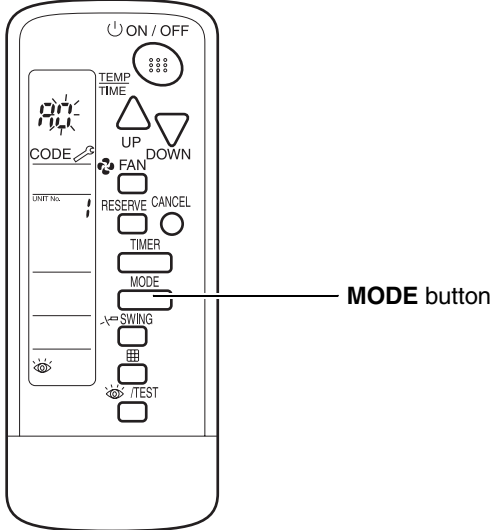
Step	Action								
<p>4</p>	<p>Press the UP or DOWN button to change the error code upper digit until the receiver of the remote controller starts to beep.</p>  <p>(R15411)</p> <table border="1" data-bbox="630 925 1388 1074"> <thead> <tr> <th>If you hear...</th> <th>Then...</th> </tr> </thead> <tbody> <tr> <td>2 short beeps</td> <td>The upper digit matches.</td> </tr> <tr> <td>1 short beep</td> <td>No digits match.</td> </tr> <tr> <td>1 continuous beep</td> <td>Both upper and lower digits match.</td> </tr> </tbody> </table>	If you hear...	Then...	2 short beeps	The upper digit matches.	1 short beep	No digits match.	1 continuous beep	Both upper and lower digits match.
If you hear...	Then...								
2 short beeps	The upper digit matches.								
1 short beep	No digits match.								
1 continuous beep	Both upper and lower digits match.								
<p>5</p>	<p>Press the MODE button. The right 0 (lower digit) indication of the error code blinks.</p>  <p>(R15412)</p>								

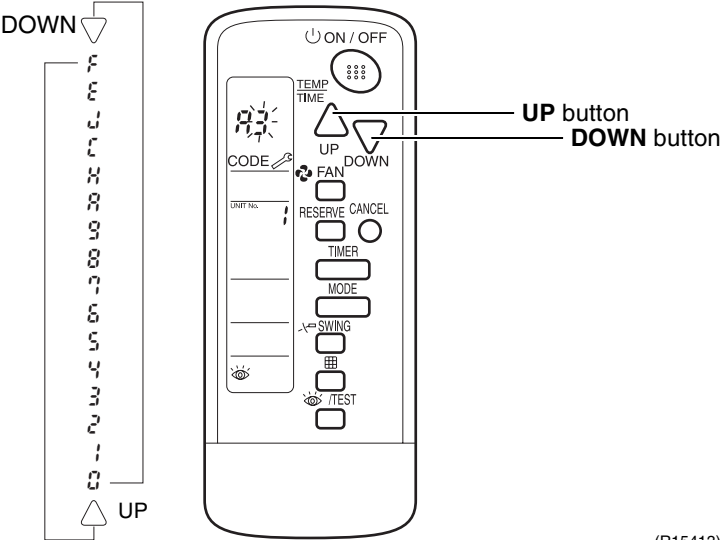
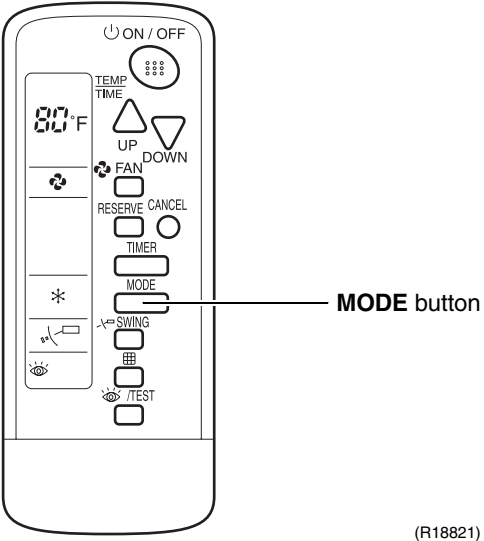
Step	Action
<p>6</p>	<p>Press the UP or DOWN button and change the error code lower digit until the receiver of the remote controller generates a continuous beep.</p>  <p style="text-align: right;">(R15413)</p>
<p>7</p>	<p>Press the MODE button to return to the normal mode. If you do not press any button for 1 minutes, the remote controller automatically returns to the normal mode.</p>  <p style="text-align: right;">(R18821)</p>

4. Code Indication on Remote Controller

4.1 CTXS, FTXS, CDXS, FDXS, FVXS Series

Error Codes	Description	Reference Page	
00	Normal condition	—	
P1	Indoor unit PCB abnormality	116	
P5	Freeze-up protection control / heating peak-cut control	118	
P6	Fan motor or related abnormality	DC motor (CTXS, FTXS, FVXS series)	119
		AC motor (CDXS, FDXS series)	121
C4	Indoor heat exchanger thermistor or related abnormality	123	
C9	Room temperature thermistor or related abnormality	123	
U4	Signal transmission error (between indoor unit and outdoor unit)	124	
UR	Unspecified voltage (between indoor unit and outdoor unit)	126	

4.2 FFQ Series

Error Codes	Description	Reference Page
00	Normal condition	—
P1	Indoor unit PCB abnormality	127
P3	Drain level control system abnormality	128
P6	Fan motor (AC motor) or related abnormality (See the Note below.)	129
P6	Drain system abnormality	130
C4	Indoor heat exchanger thermistor 1 or related abnormality	131
C5	Indoor heat exchanger thermistor 2 or related abnormality	131
C9	Room temperature thermistor or related abnormality	131
CJ	Remote controller thermistor abnormality	132
U5	Signal transmission error (between indoor unit and remote controller)	133
U8	Signal transmission error (between MAIN remote controller and SUB remote controller)	134
UR	Field setting abnormality	135

: Error code displays automatically and system stops.
Inspect and solve the error.

: In the case of the shaded error codes, inspection is not displayed. The system operates, but be sure to inspect and solve the error.



Note: When there is a possibility of open phase power supply, also check power supply.

4.3 Outdoor Unit

☀: ON, ●: OFF, ⦿: Blinks

Outdoor Unit LED Indication						Error Codes	Description	Reference Page
Green	Red							
A	1	2	3	4	5			
⦿	●	●	●	●	●	00	Normal condition	—
						UR	Unspecified voltage (between indoor unit and outdoor unit)	141
						UR	Anti-icing control in other rooms	141
⦿	●	●	☀	☀	●	(UR)	Refrigerant shortage	136
⦿	☀	●	●	☀	●	U2	Low-voltage detection or over-voltage detection	138
⦿	●	☀	●	●	●	U3	Wiring Error Check Unexecuted	140
⦿	☀	●	☀	☀	●	RS	Anti-icing control for indoor unit	142
⦿	☀	☀	☀	●	●	E1	Outdoor unit PCB abnormality	144
⦿	☀	●	☀	●	●	(EE)	OL activation (compressor overload)	145
⦿	●	☀	☀	●	●	(EE)	Compressor lock	147
⦿	☀	☀	☀	☀	●	E7	DC fan lock	148
⦿	●	☀	●	☀	●	E8	Input overcurrent detection	149
⦿	☀	●	●	●	●	ER	Four way valve abnormality	150
⦿	☀	●	☀	●	●	F3	Discharge pipe temperature control	152
⦿	☀	●	☀	☀	●	F5	High pressure control in cooling	153
⦿	☀	☀	●	●	●	H0	Compressor sensor system abnormality	154
						H5	Position sensor abnormality	156
						H8	CT or related abnormality	158
						H9	Outdoor temperature thermistor or related abnormality	160
						J3	Discharge pipe thermistor or related abnormality	160
						J5	Outdoor heat exchanger thermistor or related abnormality	160
						J8	Liquid pipe thermistor or related abnormality	160
						J9	Gas pipe thermistor or related abnormality	160
						P4	Radiation fin thermistor or related abnormality	160
⦿	☀	☀	●	☀	●	L3	Electrical box temperature rise	162
⦿	●	●	●	☀	●	L4	Radiation fin temperature rise	163
⦿	●	●	☀	●	●	L5	Output overcurrent detection	164
☀	—	—	—	—	—	—	See the note 4.	—
●	—	—	—	—	—	—	Check the power supply.	—



Note:

- The error codes in the parenthesis () are displayed only when the system is shut down.
- When a sensor error occurs, check the remote controller display to determine which sensor is malfunctioning.
If the remote controller does not indicate the error code, conduct the following procedure.
 - * Turn the power off and then on again. If the same LED indication appears again immediately after the power is turned on, the fault is in the thermistor.
 - * If the above condition does not result, the fault is in the CT.
- The indoor unit error code may take the precedence in the remote controller display.
- Turn the power off and then on again. If the same LED indication appears again, outdoor unit PCB is faulty. Replace the outdoor unit PCB.

5. Troubleshooting for CTXS, FTXS, CDXS, FDXS, FVXS Series

5.1 Indoor Unit PCB Abnormality

Error Code	A1
Method of Error Detection	The system checks if the circuit works properly within the microcomputer of the indoor unit.
Error Decision Conditions	The system cannot set the internal settings.
Supposed Causes	<ul style="list-style-type: none">■ Wrong models interconnected■ Defective indoor unit PCB■ Disconnection of connector■ Reduction of power supply voltage

Troubleshooting



Caution Be sure to turn off the power switch before connecting or disconnecting connectors, or parts may be damaged.

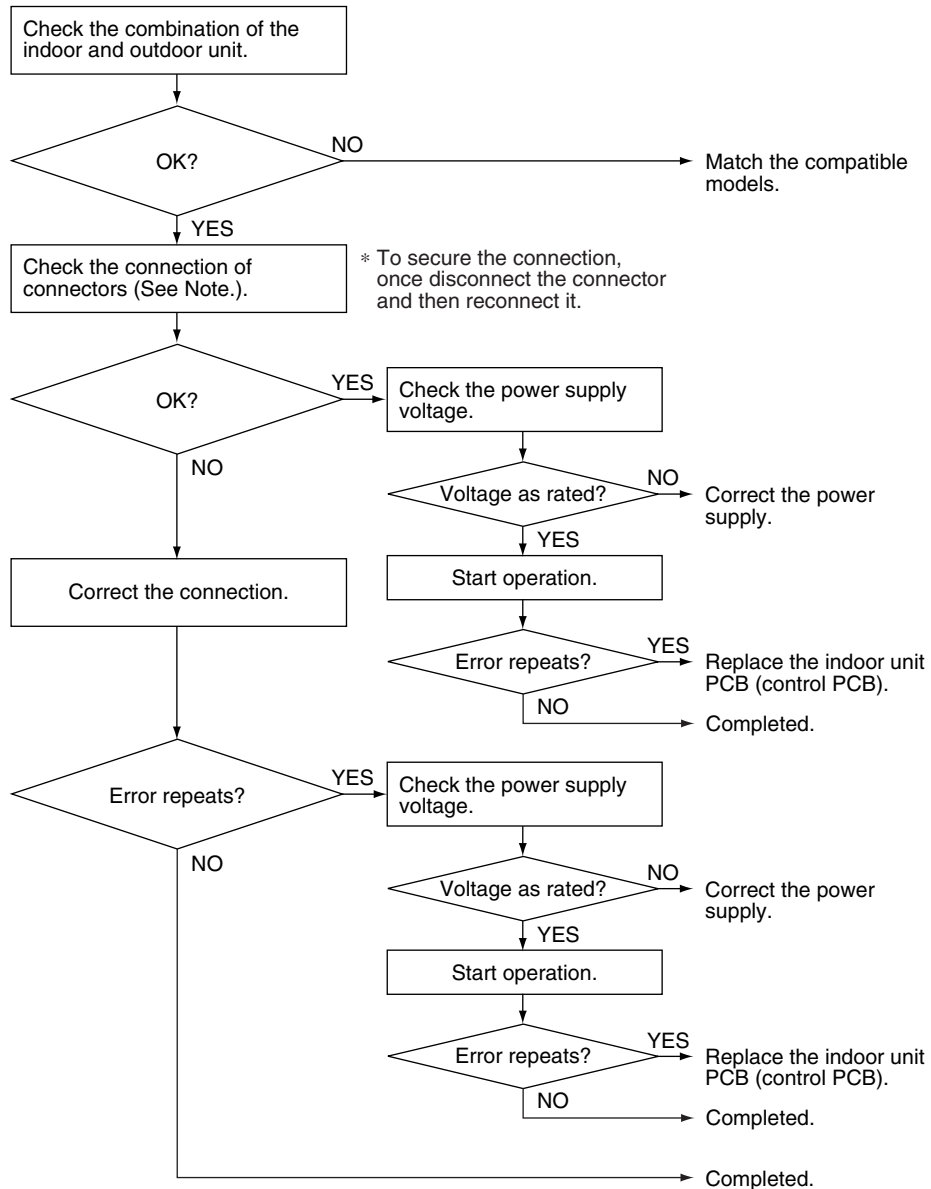

(R20421)



Note: Check the following connector.

Model Type	Connector
CTXS, FTXS, CDXS, FDXS, FVXS series	Terminal board ~ Control PCB (H1, H2, H3)

5.2 Freeze-up Protection Control / Heating Peak-cut Control

Error Code	A5
Method of Error Detection	<ul style="list-style-type: none"> ■ Freeze-up protection control During cooling operation, the freeze-up protection control (operation halt) is activated according to the temperature detected by the indoor heat exchanger thermistor. ■ Heating peak-cut control During heating operation, the temperature detected by the indoor heat exchanger thermistor is used for the heating peak-cut control (operation halt, outdoor fan stop, etc.)
Error Decision Conditions	<ul style="list-style-type: none"> ■ Freeze-up protection control During cooling operation, the indoor heat exchanger temperature is below 0°C (32°F). ■ Heating peak-cut control During heating operation, the indoor heat exchanger temperature is above 65°C (149°F).
Supposed Causes	<ul style="list-style-type: none"> ■ Short-circuited air ■ Clogged air filter of the indoor unit ■ Dust accumulation on the indoor heat exchanger ■ Defective indoor heat exchanger thermistor ■ Defective indoor unit PCB

Troubleshooting

Check No.01
 Refer to P.166

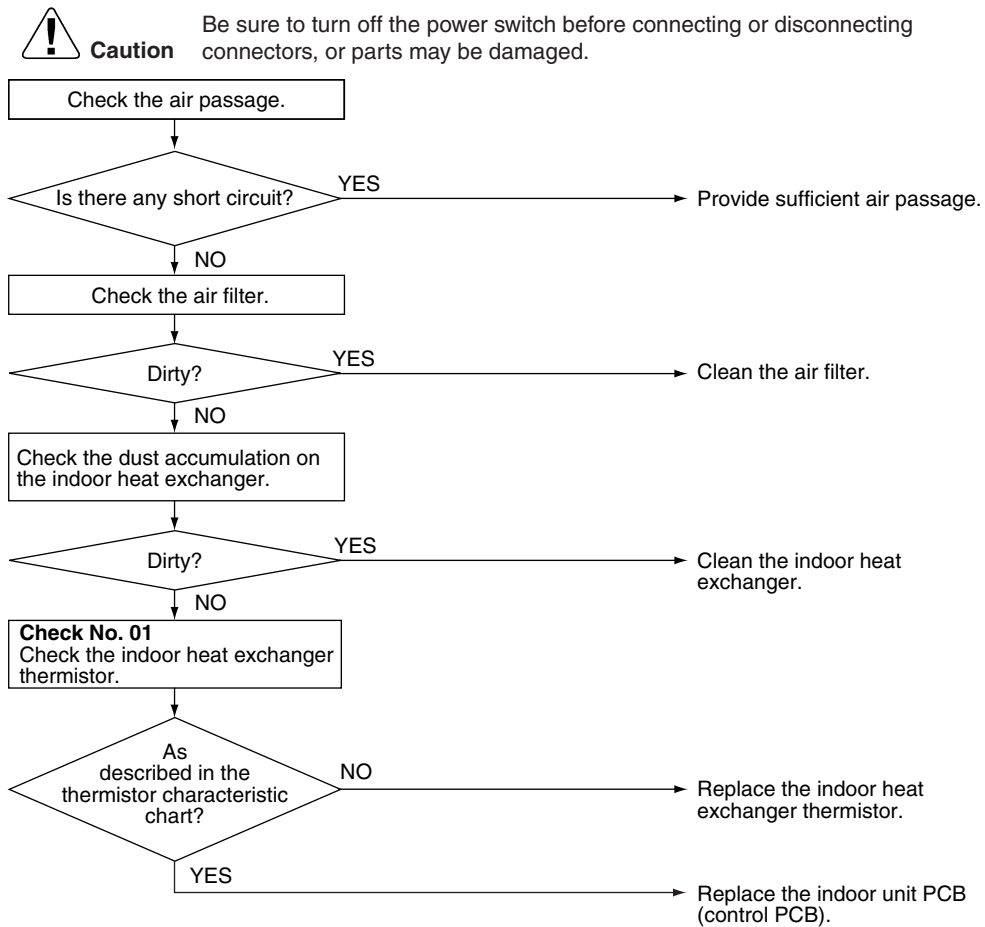

(R21064)

5.3 Fan Motor or Related Abnormality

5.3.1 DC Motor (CTXS, FTXS, FVXS Series)

Error Code	R6
Method of Error Detection	The rotation speed detected by the Hall IC during fan motor operation determines abnormal fan motor operation.
Error Decision Conditions	The detected rotation speed does not reach the demanded rotation speed of the target tap, and is less than 50% of the maximum fan motor rotation speed.
Supposed Causes	<ul style="list-style-type: none">■ Remarkable decrease in power supply voltage■ Layer short inside the fan motor winding■ Breaking of wire inside the fan motor■ Breaking of the fan motor lead wires■ Defective capacitor of the fan motor■ Defective indoor unit PCB

Troubleshooting



Check No.02
Refer to P.167



Caution

Be sure to turn off the power switch before connecting or disconnecting connectors, or parts may be damaged.

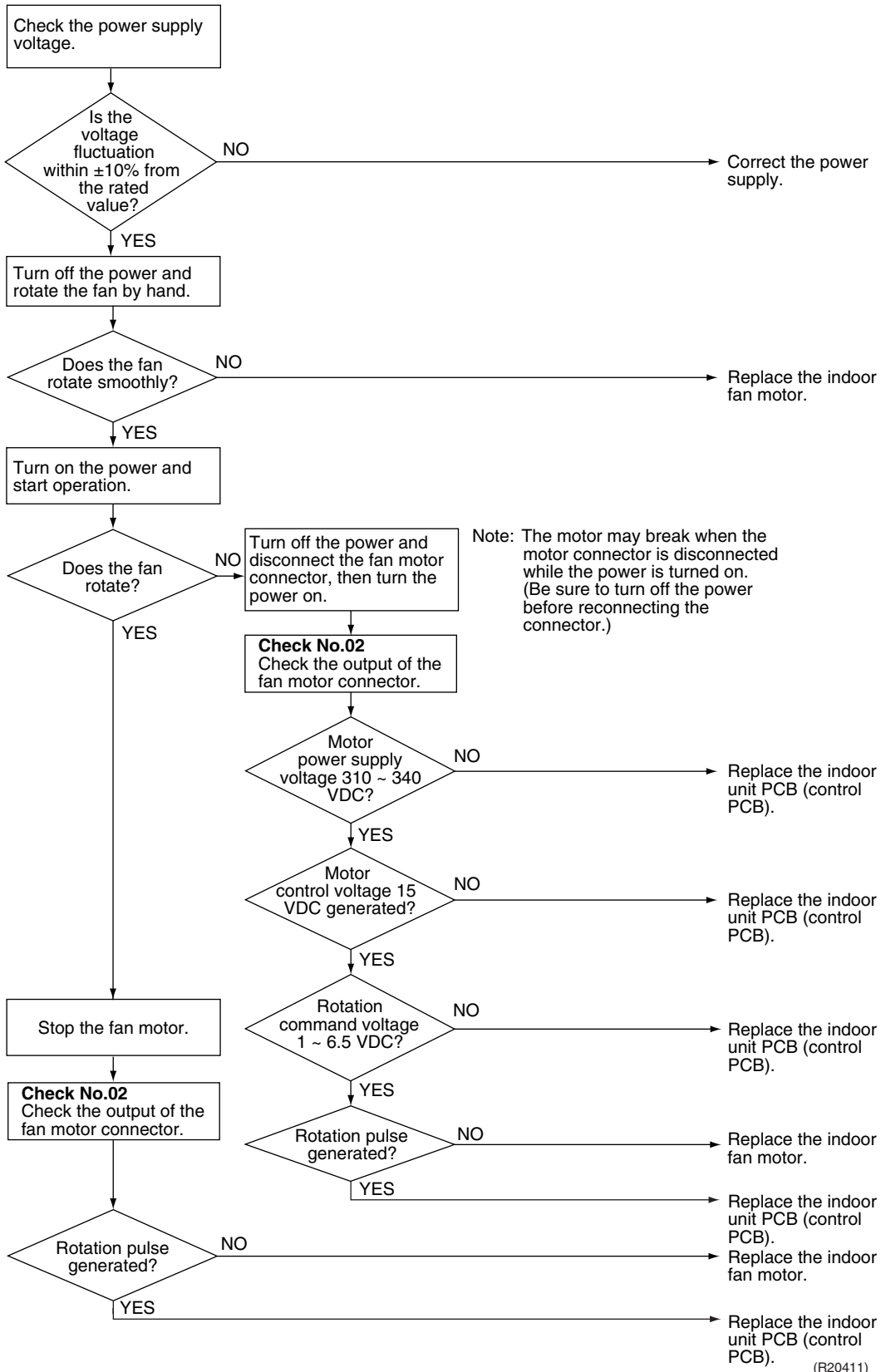

(R20411)

5.3.2 AC Motor (CDXS, FDXS Series)

Error code	A6
Method of Error Detection	The rotation speed detected by the Hall IC during fan motor operation determines abnormal fan motor operation.
Error Decision Conditions	The detected rotation speed does not reach the demanded rotation speed of the target tap.
Supposed Causes	<ul style="list-style-type: none">■ Power supply voltage is not as specified.■ Layer short inside the fan motor winding■ Breaking of wire inside the fan motor■ Breaking of the fan motor lead wires■ Defective capacitor of the fan motor■ Defective indoor unit PCB

Troubleshooting



Check No.04
Refer to P.167



Caution Be sure to turn off the power switch before connecting or disconnecting connectors, or parts may be damaged.

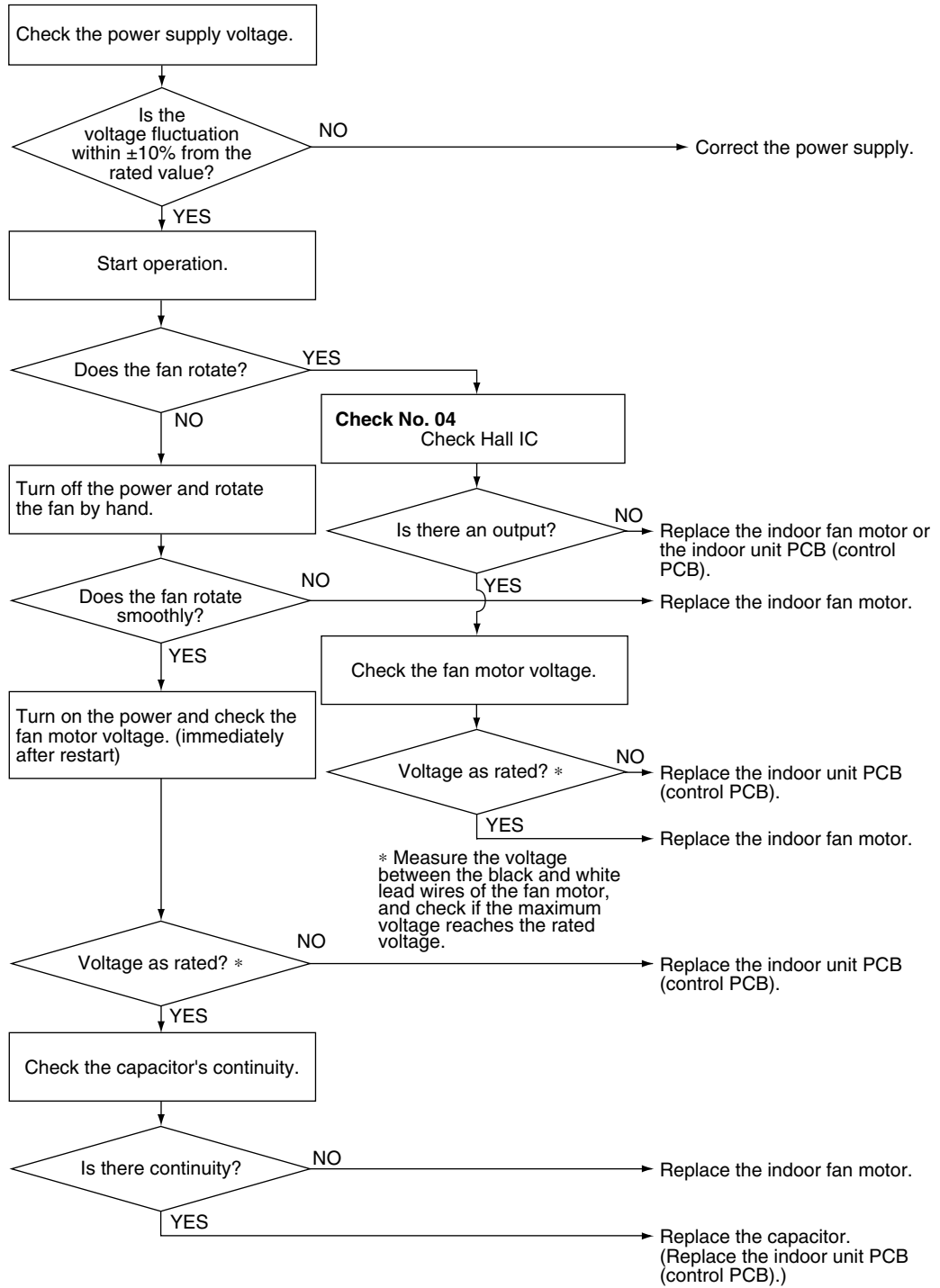

(R22267)

5.4 Thermistor or Related Abnormality

Error Code	U4, U9
Method of Error Detection	The temperatures detected by the thermistors determine thermistor errors.
Error Decision Conditions	The voltage between the both ends of the thermistor is 4.96 V and more or 0.04 V and less during compressor operation.
Supposed Causes	<ul style="list-style-type: none"> ■ Disconnection of connector ■ Thermistor corresponding to the error code is defective. ■ Defective indoor unit PCB

Troubleshooting

 **Check No.01**
Refer to P.166

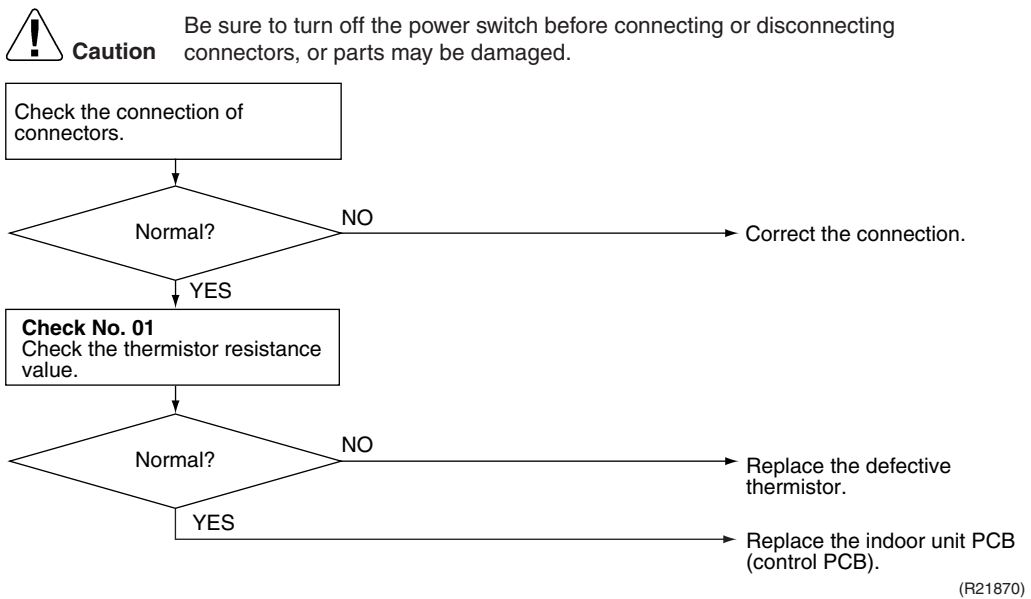

U4 : Indoor heat exchanger thermistor
U9 : Room temperature thermistor

5.5 Signal Transmission Error (Between Indoor Unit and Outdoor Unit)

Error Code	U4
Method of Error Detection	The data received from the outdoor unit in signal transmission is checked whether it is normal.
Error Decision Conditions	The data sent from the outdoor unit cannot be received normally, or the content of the data is abnormal.
Supposed Causes	<ul style="list-style-type: none">■ Reduction of power supply voltage■ Wiring error■ Breaking of the connection wires between the indoor and outdoor units (wire No. 3)■ Defective outdoor unit PCB■ Short circuit inside the fan motor winding■ Defective indoor unit PCB■ Disturbed power supply waveform

Troubleshooting



Check No.11
Refer to P.168



Caution Be sure to turn off the power switch before connecting or disconnecting connectors, or parts may be damaged.

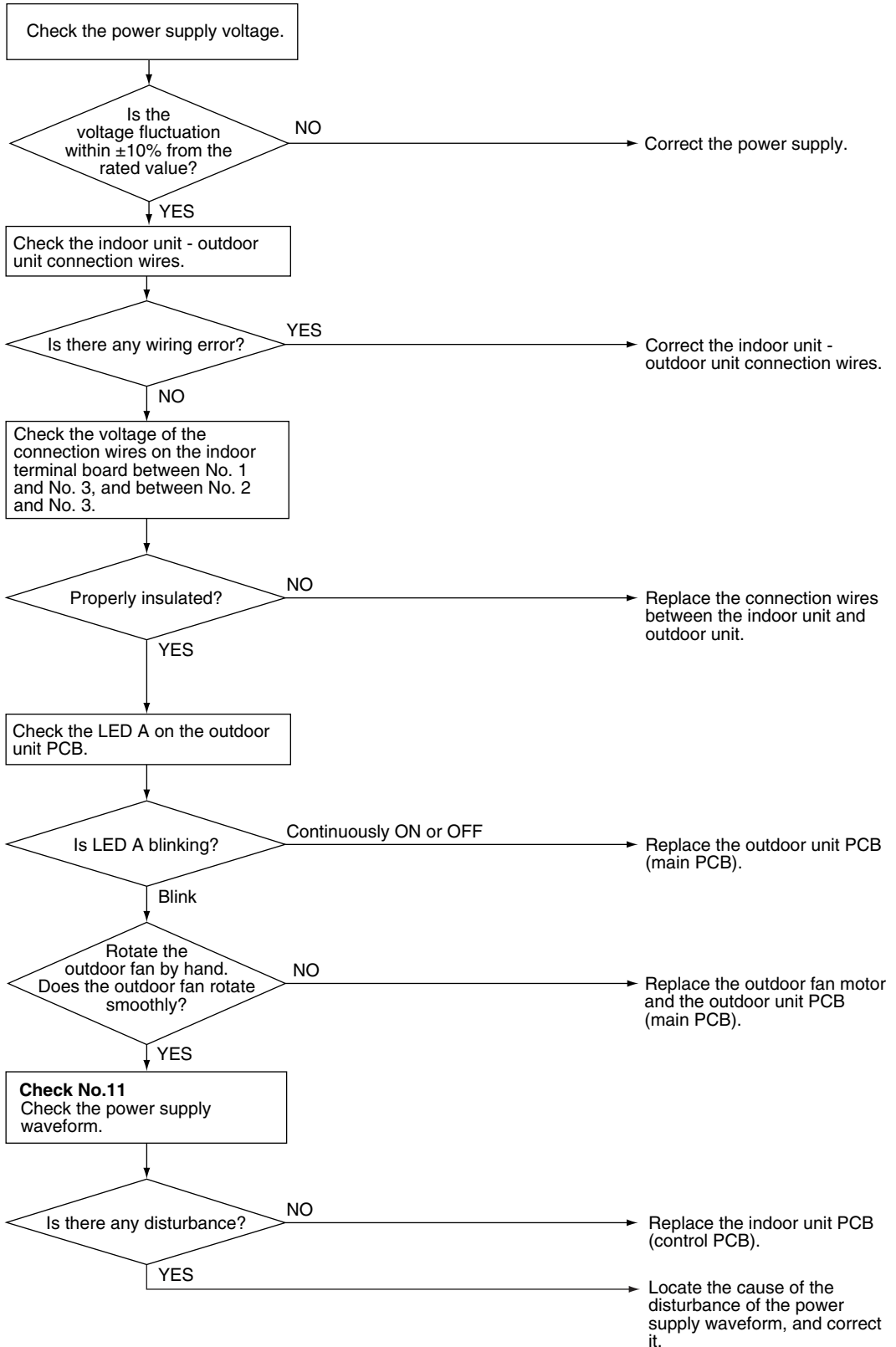

(R21193)

5.6 Unspecified Voltage (Between Indoor Unit and Outdoor Unit)

Error Code	UR
Method of Error Detection	The supply power is detected for its requirements (pair type is different from multi type) by the indoor / outdoor transmission signal.
Error Decision Conditions	The pair type and multi type are interconnected.
Supposed Causes	<ul style="list-style-type: none"> ■ Wrong models interconnected ■ Wrong wiring of connecting wires ■ Wrong indoor unit PCB or outdoor unit PCB mounted ■ Defective indoor unit PCB ■ Defective outdoor unit PCB

Troubleshooting

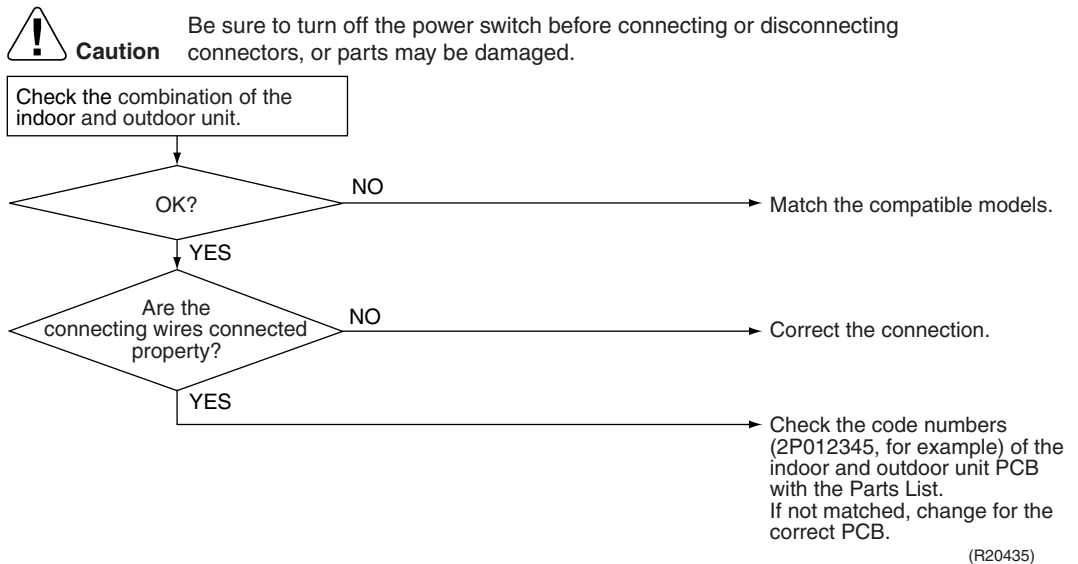

6. Troubleshooting for FFQ Series

6.1 Indoor Unit PCB Abnormality

Error Code	A1
Method of Error Detection	The system checks the data from EEPROM.
Error Decision Conditions	<p>The data from the EEPROM is not received correctly.</p> <p>EEPROM (Electrically Erasable Programmable Read Only Memory): A memory chip that holds its content without power. It can be erased, either within the computer or externally and usually requires more voltage for erasure than the common +5 volts used in logic circuits. It functions like non-volatile RAM, but writing to EEPROM is slower than writing to RAM.</p>
Supposed Causes	<ul style="list-style-type: none"> ■ Defective indoor unit PCB ■ External factor (noise etc.)

Troubleshooting

Caution

Be sure to turn off the power switch before connecting or disconnecting connectors, or parts may be damaged.

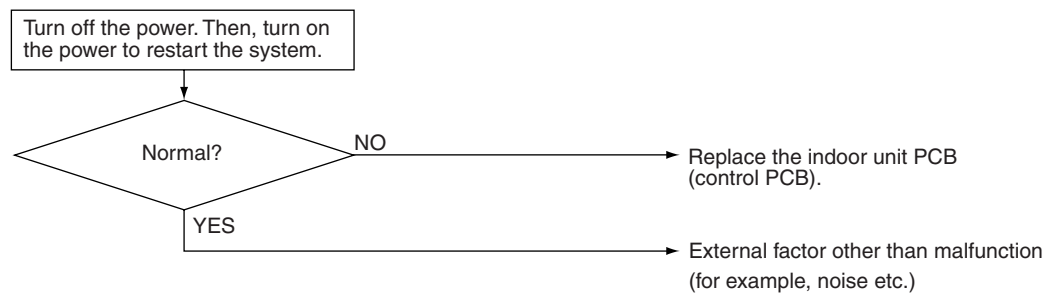

(R22247)

6.2 Drain Level Control System Abnormality

Error Code	A3
Method of Error Detection	The float switch detects error.
Error Decision Conditions	The water level reaches its upper limit and the float switch turns OFF.
Supposed Causes	<ul style="list-style-type: none"> ■ Defective drain pump ■ Improper drain piping work ■ Clogged drain piping ■ Defective float switch ■ Defective indoor unit PCB ■ Defective short circuit connector X15A on indoor unit PCB

Troubleshooting

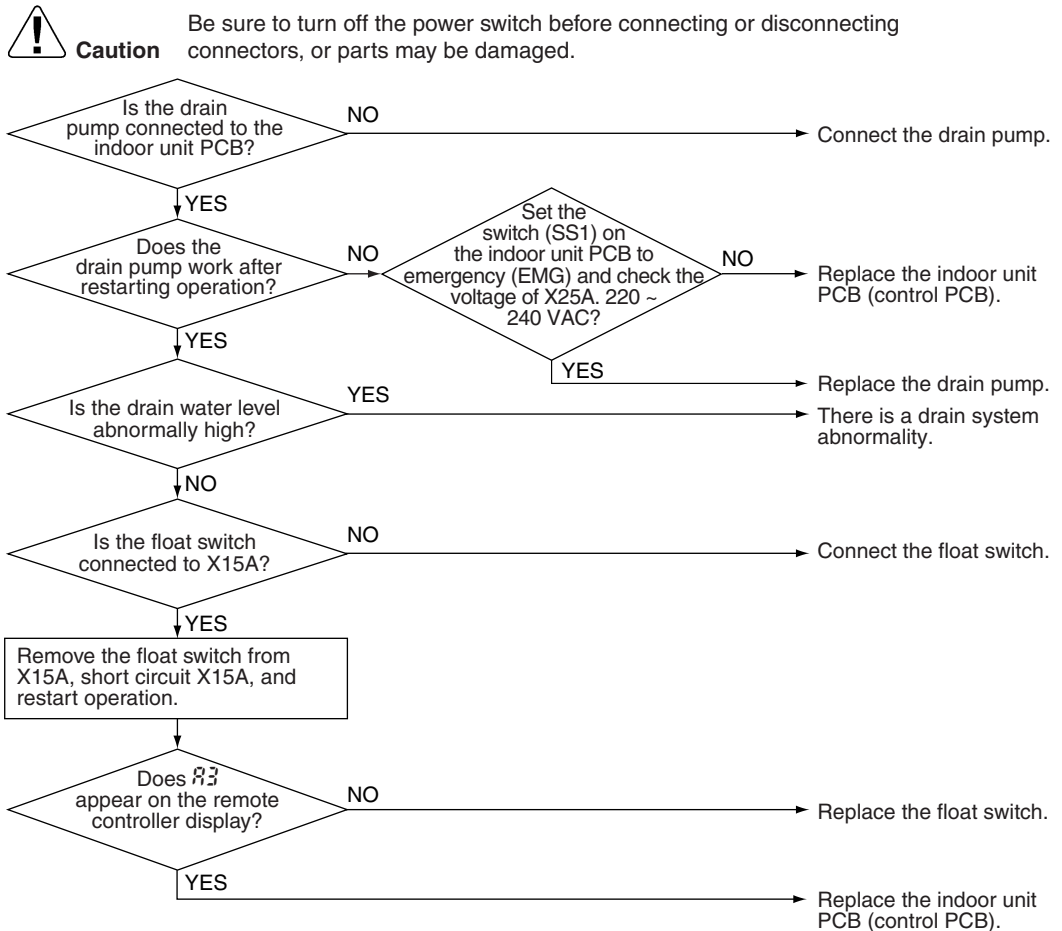

(R22268)

 **Note:** For the location of the switch (SS1), refer to page 26.

6.3 Fan Motor (AC Motor) or Related Abnormality

Error Code

R6

Method of Error Detection

The signal from the fan motor detects abnormal fan speed.

Error Decision Conditions

The fan rotations are not detected while the output voltage to the fan is at its maximum.

Supposed Causes

- Disconnection, short circuit or disengagement of connector in fan motor harness
- Defective fan motor (disconnection, poor insulation)
- Abnormal signal from fan motor (faulty circuit)
- Defective indoor unit PCB
- Momentary fluctuation of power supply voltage
- Fan motor lock (Caused by motor or other external factors)
- Fan does not rotate due to tangled foreign matters.

Troubleshooting



Caution

Be sure to turn off the power switch before connecting or disconnecting connectors, or parts may be damaged.

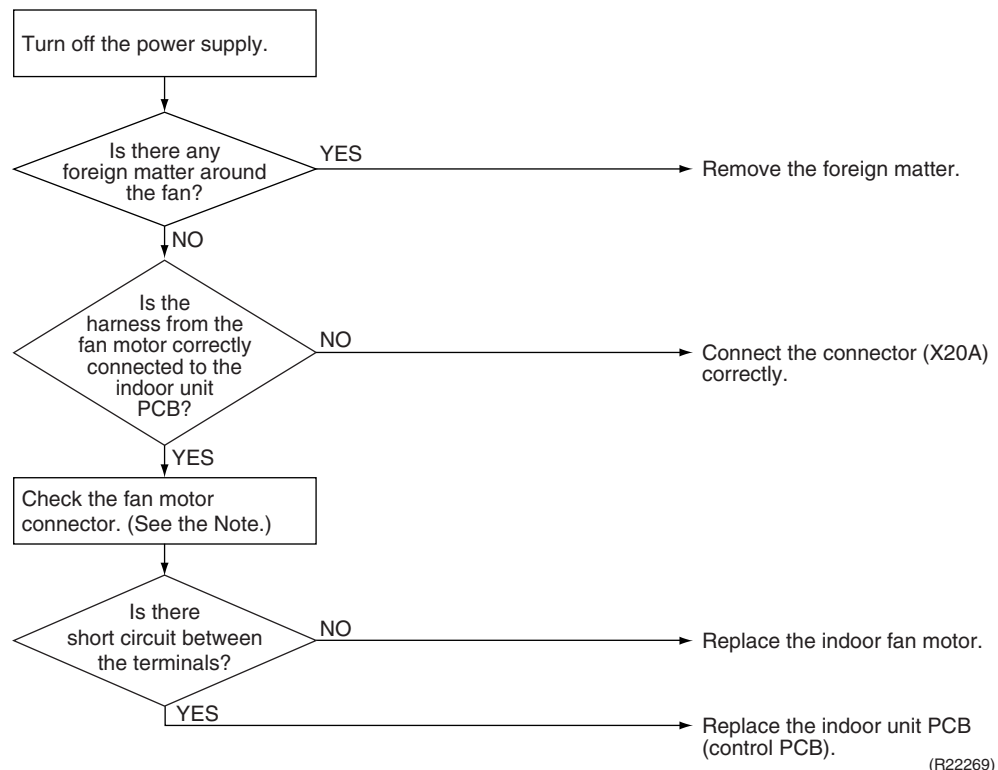

Note:

1. Check the connector of fan motor. (Power supply cable)
2. Turn OFF the power supply.
3. Measure the resistance between the terminals at the motor side connectors to check that there is no short circuit, while the connector is disconnected.

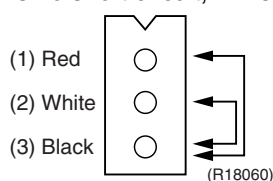

Measuring points	Resistance for judgement
(1) - (3)	88.2 Ω ± 10%
(2) - (3)	85.5 Ω ± 10%

6.4 Drain System Abnormality

Error Code	AF
Method of Error Detection	Water leakage is detected based on the float switch ON/OFF changeover while the compressor is not operating.
Error Decision Conditions	The float switch changes from ON to OFF while the compressor is OFF.
Supposed Causes	<ul style="list-style-type: none"> ■ Error in the drain pipe installation ■ Defective float switch ■ Defective indoor unit PCB

Troubleshooting



Caution Be sure to turn off the power switch before connecting or disconnecting connectors, or parts may be damaged.

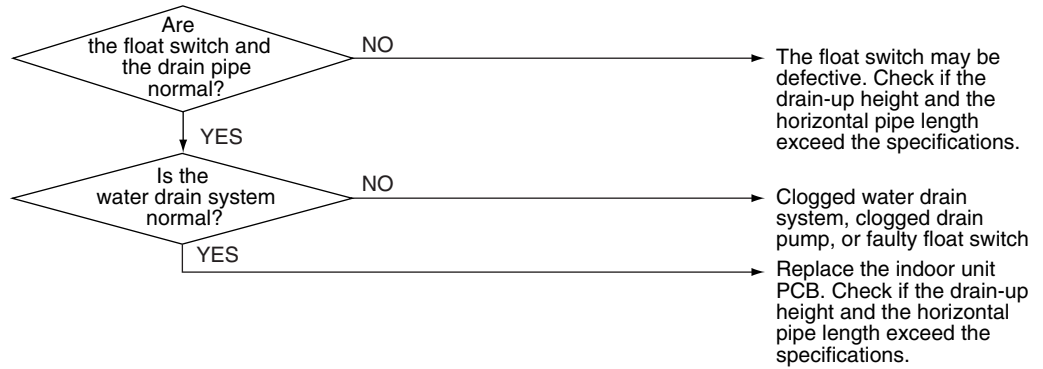

(R16022)

6.5 Thermistor or Related Abnormality

Error Code	ε4, ε5, ε9
Method of Error Detection	The temperatures detected by the thermistors determine thermistor errors.
Error Decision Conditions	The voltage between the both ends of the thermistor is 4.96 V and more or 0.04 V and less during compressor operation.
Supposed Causes	<ul style="list-style-type: none"> ■ Disconnection of connector ■ Thermistor corresponding to the error code is defective. ■ Defective indoor unit PCB

Troubleshooting If the cause of the problem is related to the thermistors, the thermistors should be checked prior to changing the indoor unit PCB.



Check No.01
Refer to P.166

To check the thermistors, proceed as follows:

Step	Action
1	Disconnect the thermistor from the indoor unit PCB.
2	Read the temperature and the resistance value.
3	Check if the measured values correspond with the values in the table of thermistor resistance check.

Caution Be sure to turn off the power switch before connecting or disconnecting connectors, or parts may be damaged.

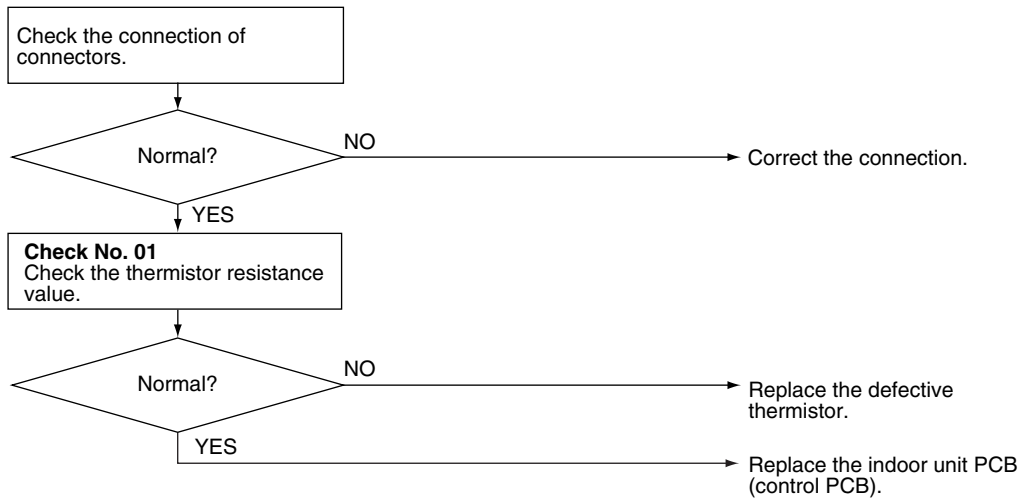

(R21870)

- ε4 : Indoor heat exchanger thermistor 1 (liquid pipe) (R2T)
- ε5 : Indoor heat exchanger thermistor 2 (R3T)
- ε9 : Room temperature thermistor (R1T)

6.6 Remote Controller Thermistor Abnormality

Error Code	
Method of Error Detection	Even if remote controller thermistor is faulty, system is possible to operate by system thermistor. Malfunction detection is carried out by the temperature detected by the remote controller thermistor.
Error Decision Conditions	The remote controller thermistor is disconnected or shorted while the unit is running.
Supposed Causes	<ul style="list-style-type: none"> ■ Defective thermistor ■ Broken wire

Troubleshooting

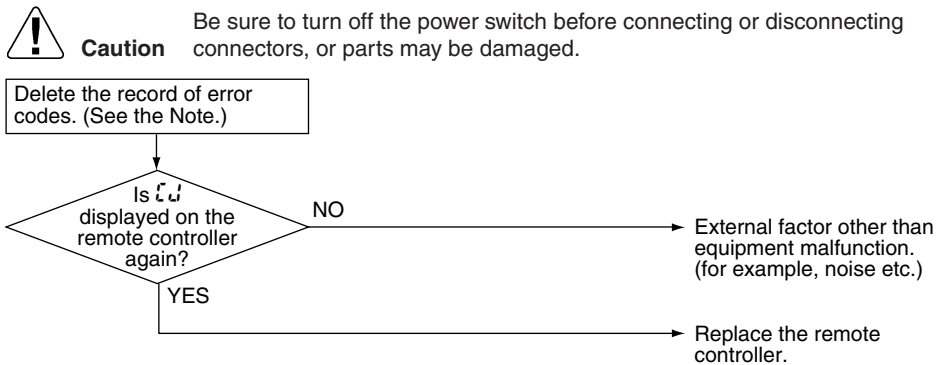

(R21111)

Note: To delete the record of error codes, press the **ON/OFF** button for 4 seconds or more while the error code is displayed in the inspection mode.

6.7 Signal Transmission Error (Between Indoor Unit and Remote Controller)

Error Code	U5
Method of Error Detection	In case of controlling with 2 remote controllers, check the system using microcomputer if signal transmission between indoor unit and remote controller (main and sub) is normal.
Error Decision Conditions	Normal transmission does not continue for specified period.
Supposed Causes	<ul style="list-style-type: none"> ■ Connection of 2 main remote controllers (when using 2 remote controllers) ■ Defective indoor unit PCB ■ Defective remote controller ■ Transmission error caused by noise
Troubleshooting	

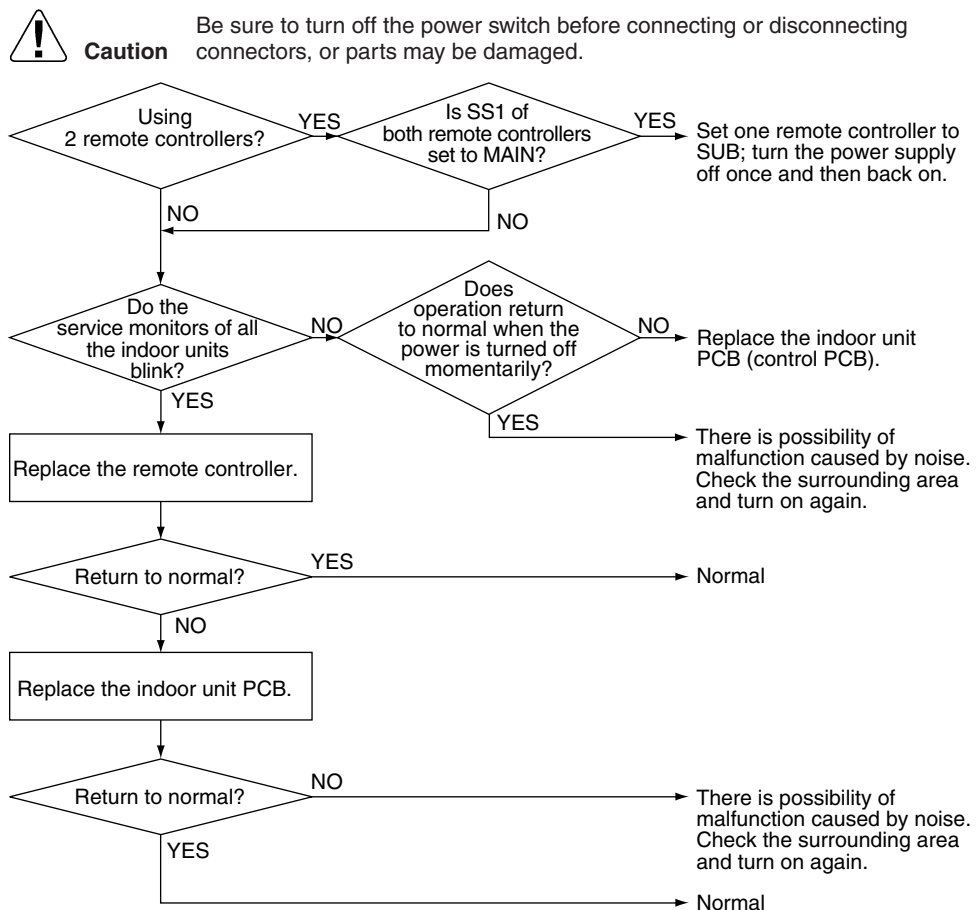

(R22251)

6.8 Signal Transmission Error (Between MAIN Remote Controller and SUB Remote Controller)

Error Code	U8
Method of Error Detection	In case of controlling with 2 remote controllers, check the system using microcomputer if signal transmission between MAIN remote controller and SUB remote controller is normal.
Error Decision Conditions	Normal transmission does not continue for specified period.
Supposed Causes	<ul style="list-style-type: none"> ■ Remote controller is set to SUB when using 1 remote controller ■ Connection of 2 sub remote controllers (when using 2 remote controllers) ■ Defective remote controller PCB

Troubleshooting

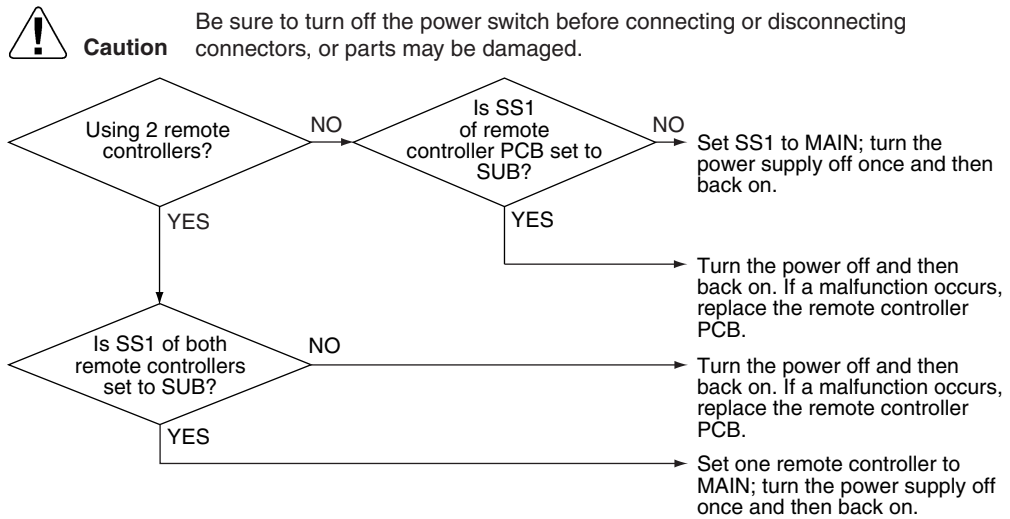

(R21113)

6.9 Field Setting Abnormality

Error Code	U8
Error Decision Conditions	Incorrect field setting
Supposed Causes	<ul style="list-style-type: none"> ■ Defective indoor unit PCB ■ Defective outdoor unit PCB ■ Improper power supply ■ Indoor-outdoor, indoor-indoor unit transmission wiring ■ Defective remote controller wiring

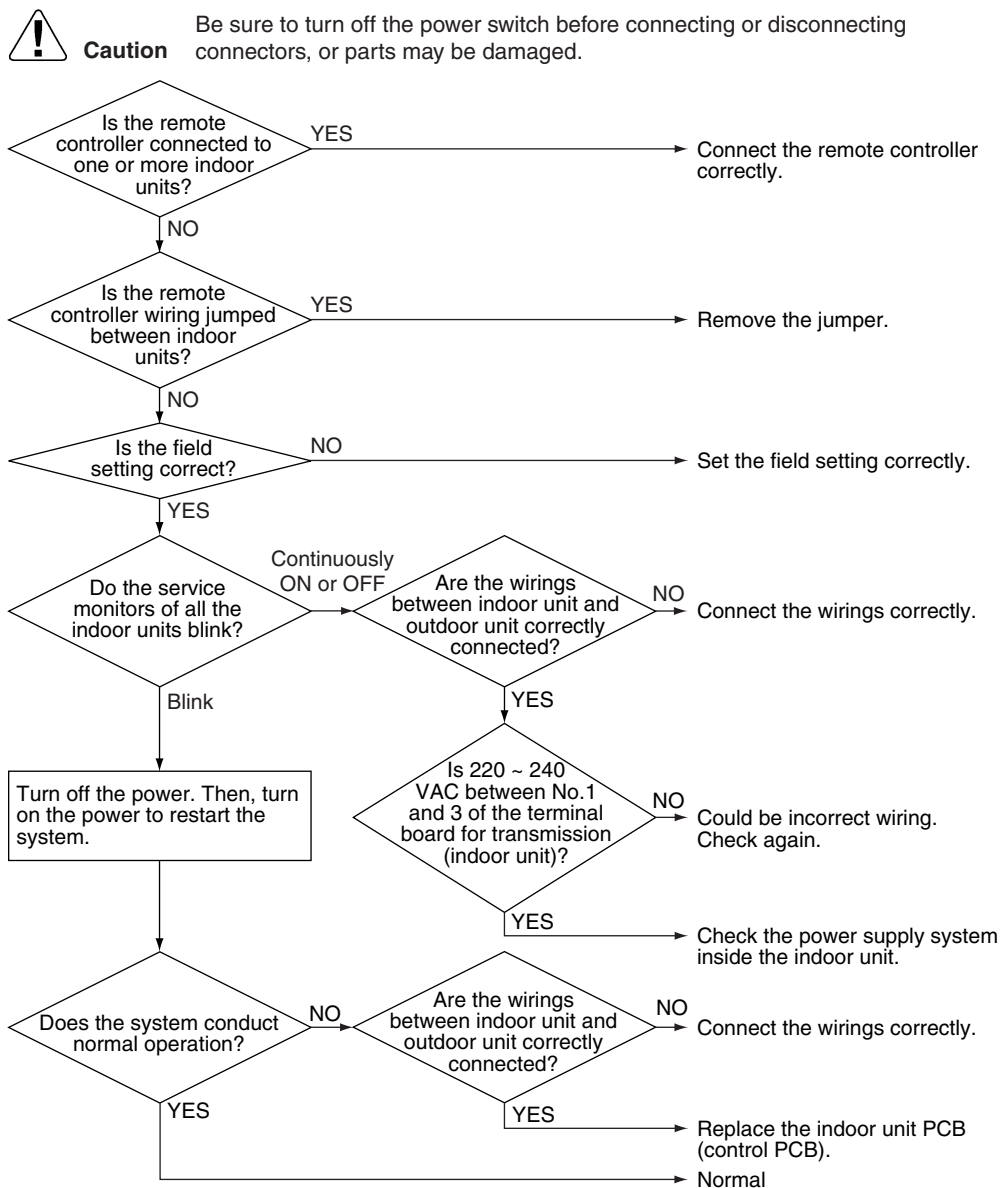

Troubleshooting



(R22125)

7. Troubleshooting for Outdoor Unit

7.1 Refrigerant Shortage

Error Code	U0												
Outdoor Unit LED Display	A  1 ● 2 ● 3  4  5 ●												
Method of Error Detection	Refrigerant shortage is detected by checking the input current value and the compressor output frequency. If the refrigerant is short, the input current is smaller than the normal value.												
Error Decision Conditions	<p>The following conditions continue for 7 minutes.</p> <ul style="list-style-type: none"> ◆ Input current $\leq A \times \text{output frequency} + B$ ◆ Output frequency $> C$ <table border="1" style="margin-left: 20px;"> <thead> <tr> <th></th> <th>A (-)</th> <th>B (A)</th> <th>C (Hz)</th> </tr> </thead> <tbody> <tr> <td>18 class</td> <td>10/1000</td> <td>0.3</td> <td>54</td> </tr> <tr> <td>24/36 class</td> <td>27/1000</td> <td>2</td> <td>40</td> </tr> </tbody> </table> <ul style="list-style-type: none"> ■ If the error repeats, the system is shut down. ■ Reset condition: Continuous run for about 60 minutes without any other error 		A (-)	B (A)	C (Hz)	18 class	10/1000	0.3	54	24/36 class	27/1000	2	40
	A (-)	B (A)	C (Hz)										
18 class	10/1000	0.3	54										
24/36 class	27/1000	2	40										
Supposed Causes	<ul style="list-style-type: none"> ■ Disconnection of the discharge pipe thermistor, indoor or outdoor heat exchanger thermistor, room or outdoor temperature thermistor ■ Closed stop valve ■ Refrigerant shortage (refrigerant leakage) ■ Poor compression performance of compressor ■ Defective electronic expansion valve 												

Troubleshooting



Check No.01
Refer to P.166



Check No.12
Refer to P.169





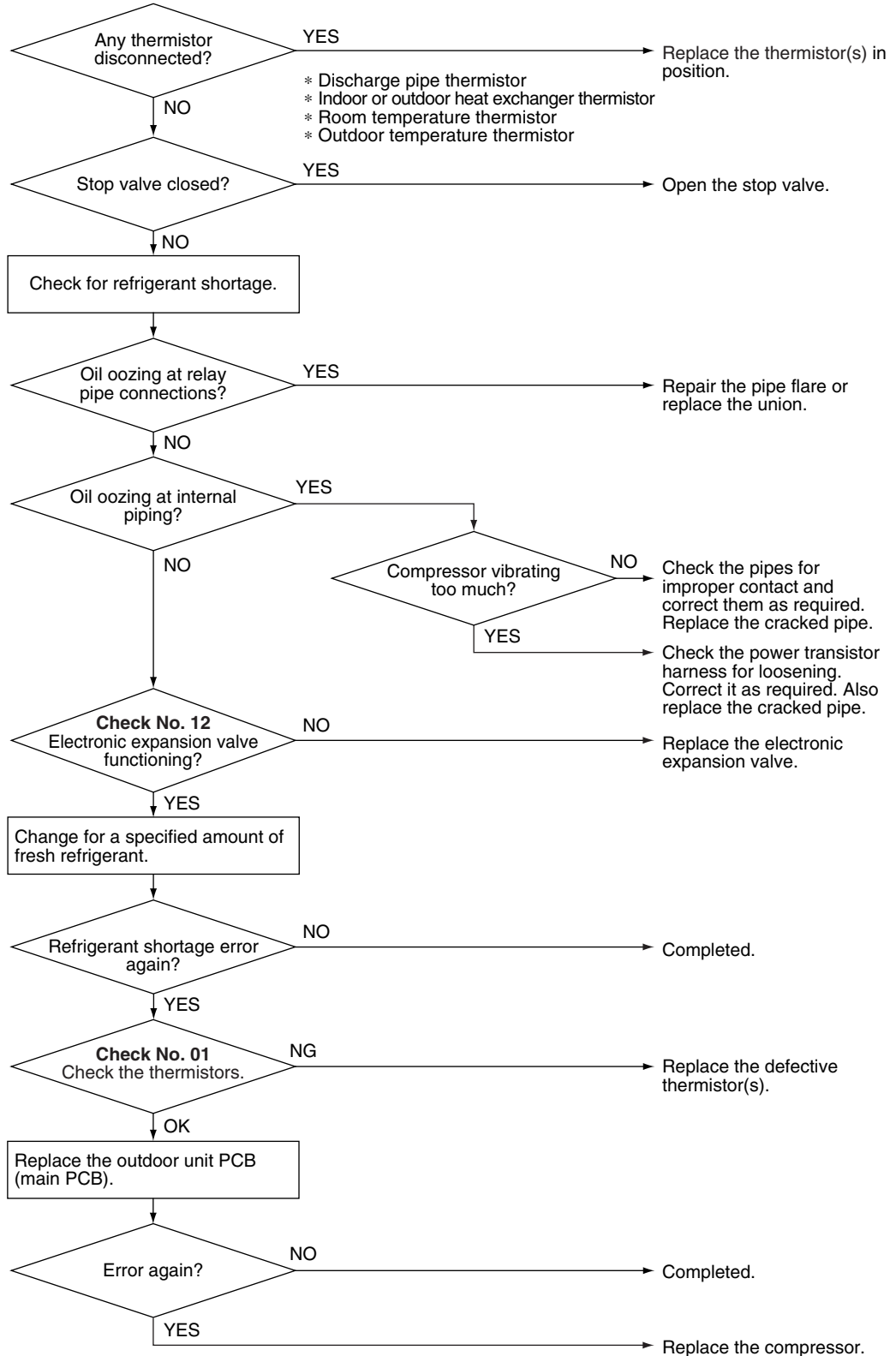

Caution Be sure to turn off the power switch before connecting or disconnecting connectors, or parts may be damaged.



(R20401)

7.2 Low-voltage Detection or Over-voltage Detection

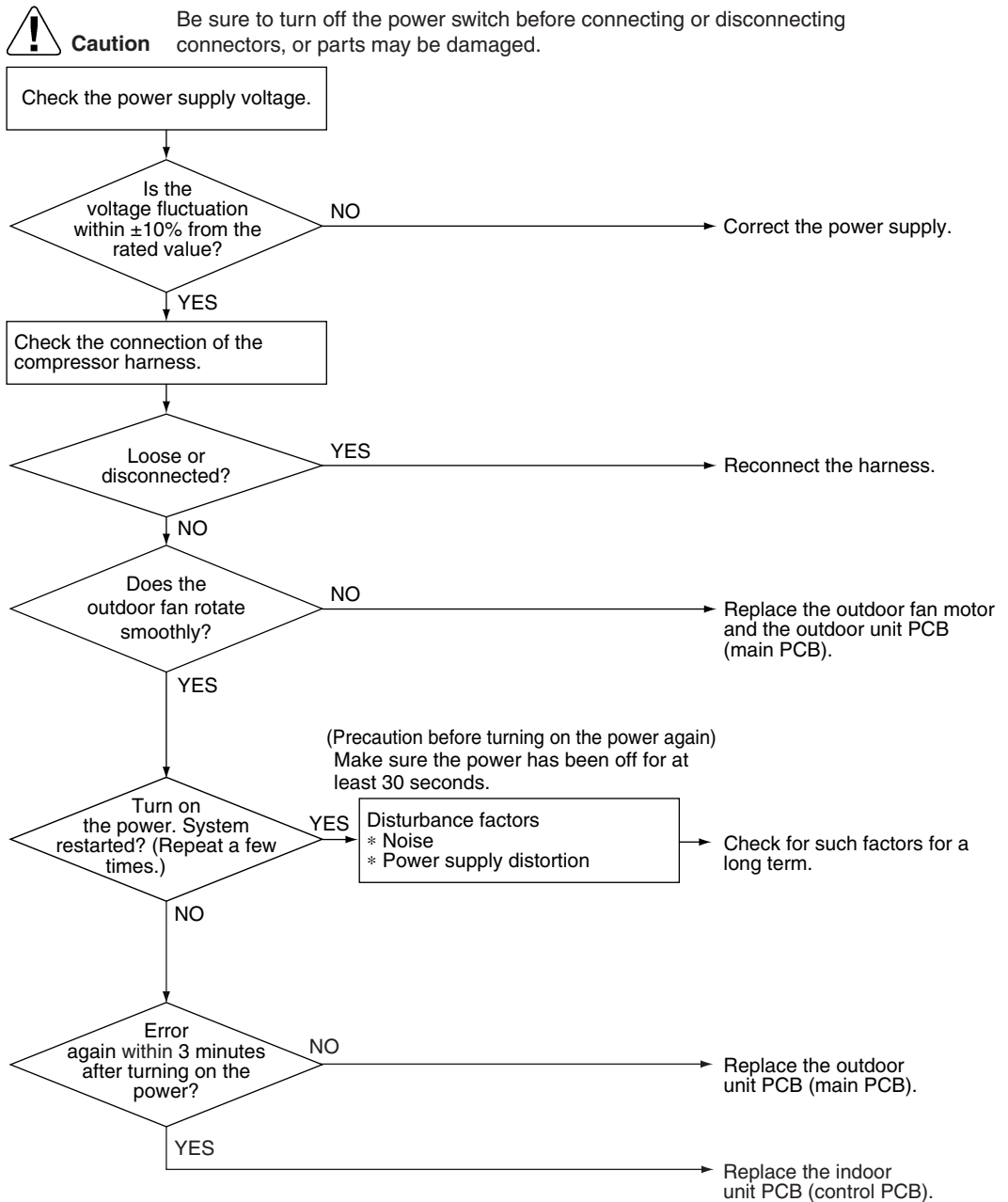

Error Code	U2
Outdoor Unit LED Display	A  1  2  3  4  5
Method of Error Detection	<p>★ Indoor Unit</p> <p>The zero-cross detection of the power supply is evaluated by the indoor unit PCB.</p> <p>★ Outdoor Unit</p> <p>Low-voltage detection: An abnormal voltage drop is detected by the DC voltage detection circuit.</p> <p>Over-voltage detection: An abnormal voltage rise is detected by the over-voltage detection circuit.</p>
Error Decision Conditions	<p>★ Indoor Unit</p> <p>There is no zero-cross detection in approximately 10 seconds.</p> <p>★ Outdoor Unit</p> <p>Low-voltage detection:</p> <ul style="list-style-type: none"> ■ The voltage detected by the DC voltage detection circuit is below 150 V for 0.1 second. ■ If the error repeats, the system is shut down. ■ Reset condition: Continuous run for about 60 minutes without any other error <p>Over-voltage detection:</p> <ul style="list-style-type: none"> ■ An over-voltage signal is fed from the over-voltage detection circuit to the microcomputer. ■ The compressor stops if the error occurs, and restarts automatically after 3-minute standby.
Supposed Causes	<ul style="list-style-type: none"> ■ Power supply voltage is not as specified. ■ Defective DC voltage detection circuit ■ Defective over-voltage detection circuit ■ Defective PAM control part ■ Disconnection of compressor harness ■ Short circuit inside the fan motor winding ■ Noise ■ Momentary drop of voltage ■ Momentary power failure ■ Defective outdoor unit PCB ■ Defective indoor unit PCB

Troubleshooting



(R20413)

7.3 Wiring Error Check Unexecuted

Error Code	U3
Outdoor Unit LED Display	A  1 ● 2  3 ● 4 ● 5 ●
Method of Error Detection	The system checks if wiring error check is executed after clearing the memory.
Error Decision Conditions	An error is determined when the unit is operated by the remote controller without executing wiring error check after the memory was cleared.
Supposed Causes	The wiring error switch (SW3) may have been pressed for 10 seconds or more and the memory may have been deleted. The unit cannot be operated unless wiring error check is executed.

Troubleshooting



Caution

Be sure to turn off the power switch before connecting or disconnecting connectors, or parts may be damaged.

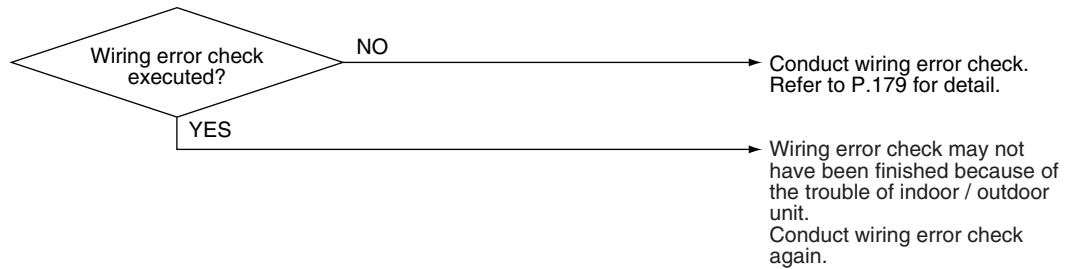

(R22429)

7.4 Unspecified Voltage (Between Indoor Unit and Outdoor Unit) / Anti-icing Control in Other Rooms

Error Code	UR, UR
Outdoor Unit LED Display	A  1 ● 2 ● 3 ● 4 ● 5 ●
Method of Error Detection	A wrong connection is detected by checking the combination of indoor and outdoor units on the microcomputer.
Error Decision Conditions	<ul style="list-style-type: none"> ■ Anti-icing control in other rooms ■ Unspecified internal and/or external voltages ■ Mismatching of indoor and outdoor units
Supposed Causes	<ul style="list-style-type: none"> ■ Anti-icing function in other rooms ■ Power supply voltage is not as specified. ■ Wrong models interconnected ■ Wrong indoor unit PCB or outdoor unit PCB mounted

Troubleshooting

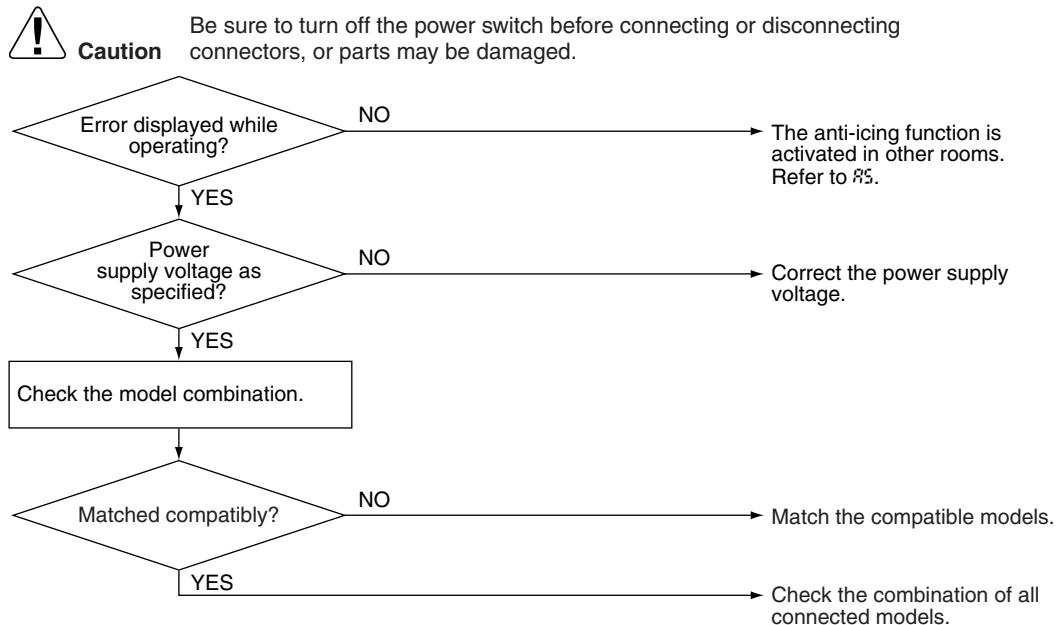





(R21922)



Note: Refer to Anti-icing control for indoor unit on page 142 for detail.

7.5 Anti-icing Control for Indoor Unit

Error Code	A5
Outdoor Unit LED Display	A  1  2  3  4  5
Method of Error Detection	During cooling operation, indoor unit icing is detected by checking the temperatures sensed by the indoor heat exchanger thermistor and room temperature thermistor that are located in a shut-down room.
Error Decision Conditions	<ul style="list-style-type: none"> ■ In cooling operation, the both conditions (A) and (B) are met for 5 minutes. <ul style="list-style-type: none"> (A) Room temperature – Indoor heat exchanger temperature $\geq 10^{\circ}\text{C}$ (18°F) (B) Indoor heat exchanger temperature $\leq -1^{\circ}\text{C}$ (30.2°F) ■ If the error repeats, the system is shut down. ■ Reset condition: 3-minute standby is over and the indoor heat exchanger temperature is above 0°C (32°F)
Supposed Causes	<ul style="list-style-type: none"> ■ Wrong wiring or piping ■ Defective electronic expansion valve ■ Short-circuited air ■ Defective indoor heat exchanger thermistor ■ Defective room temperature thermistor

Troubleshooting



Check No.01
Refer to P.166



Check No.12
Refer to P.169



Caution

Be sure to turn off the power switch before connecting or disconnecting connectors, or parts may be damaged.

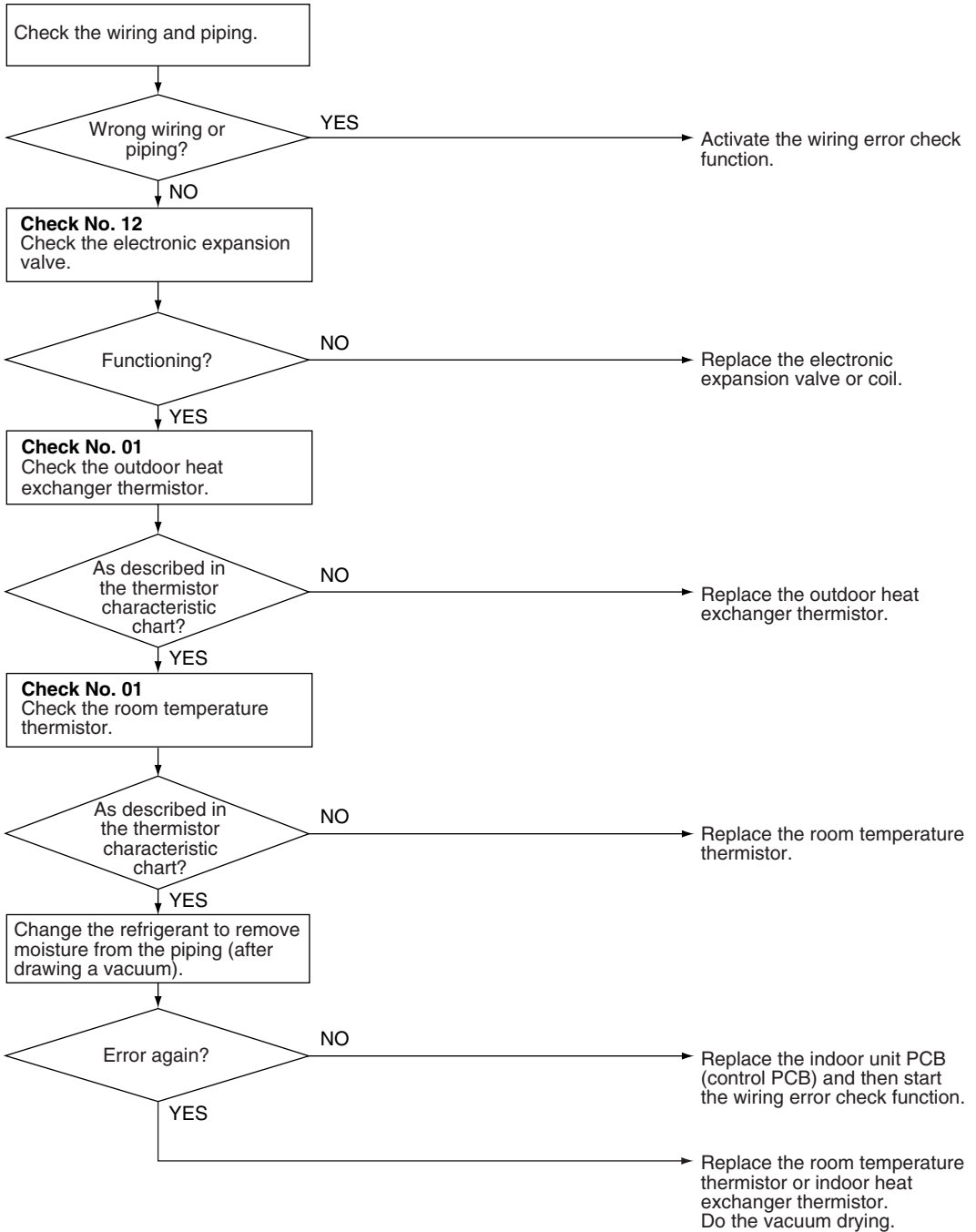

(R21923)

7.6 Outdoor Unit PCB Abnormality



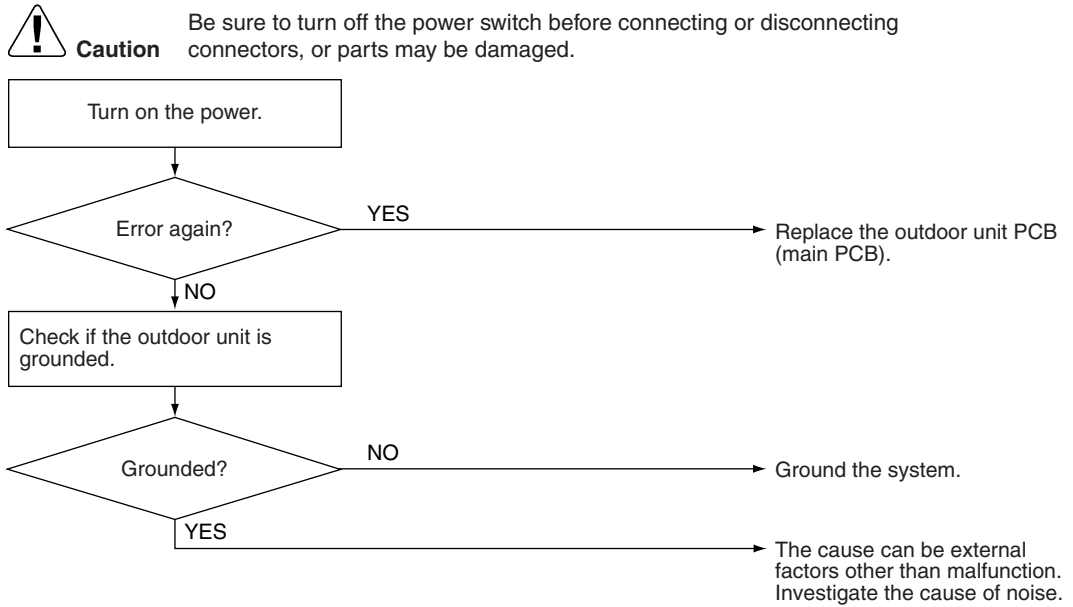

Error Code	E1
Outdoor Unit LED Display	A ● 1 ● 2 ● 3 ● 4 ● 5 ●
Method of Error Detection	Detect within the program of the microcomputer.
Error Decision Conditions	The program of the microcomputer is in abnormal running order.
Supposed Causes	<ul style="list-style-type: none"> ■ Defective outdoor unit PCB ■ Noise ■ Momentary drop of voltage ■ Momentary power failure

Troubleshooting



(R21809)

7.7 OL Activation (Compressor Overload)

Error Code	E5
Outdoor Unit LED Display	A  1  2  3  4  5
Method of Error Detection	A compressor overload is detected through compressor OL.
Error Decision Conditions	<ul style="list-style-type: none"> ■ If the error repeats, the system is shut down. ■ Reset condition: Continuous run for about 60 minutes without any other error
Supposed Causes	<ul style="list-style-type: none"> ■ Disconnection of discharge pipe thermistor ■ Defective discharge pipe thermistor ■ Disconnection of connector S40 ■ Disconnection of 2 terminals of OL (Q1L) ■ Defective OL (Q1L) ■ Broken OL harness ■ Defective electronic expansion valve or coil ■ Defective four way valve or coil ■ Defective outdoor unit PCB ■ Refrigerant shortage ■ Water mixed in refrigerant ■ Defective stop valve

Troubleshooting



Check No.01
Refer to P.166



Check No.12
Refer to P.169



Check No.13
Refer to P.170



Check No.14
Refer to P.170



Caution Be sure to turn off the power switch before connecting or disconnecting connectors, or parts may be damaged.

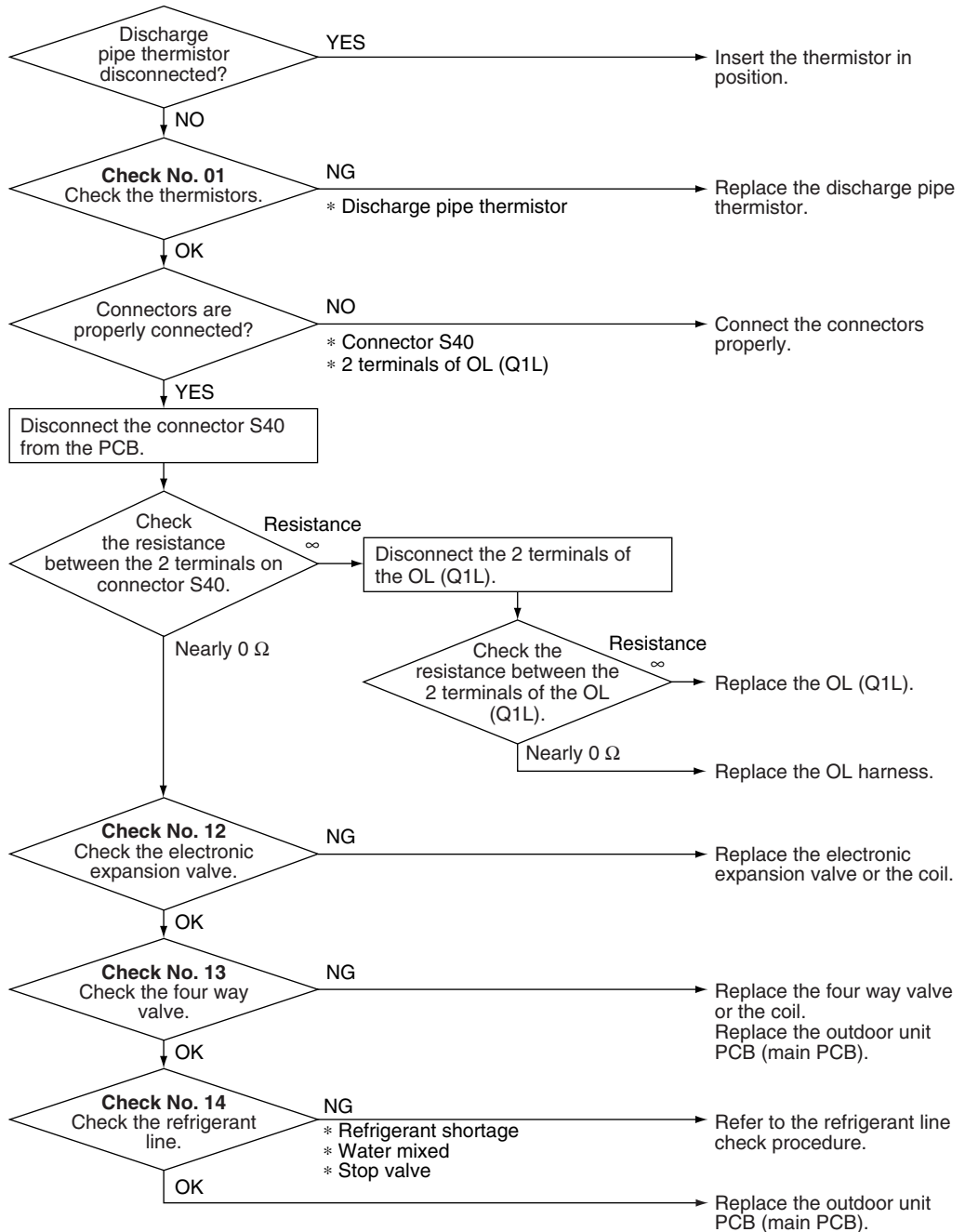

Note: OL (Q1L) activating temperature: 130°C (266°F)
OL (Q1L) recovery temperature: 95°C (203°F)

(R20415)

7.8 Compressor Lock

Error Code	EE
Outdoor Unit LED Display	A ● 1 ● 2 ● 3 ● 4 ● 5 ●
Method of Error Detection	A compressor lock is detected by checking the compressor running condition through the position detection circuit.
Error Decision Conditions	<ul style="list-style-type: none"> ■ Judging from the current waveform generated when high-frequency voltage is applied to the compressor. ■ If the error repeats, the system is shut down. ■ Reset condition: Continuous run for about 5 minutes without any other error
Supposed Causes	<ul style="list-style-type: none"> ■ Closed stop valve ■ Defective outdoor unit PCB ■ Defective compressor ■ Defective electronic expansion valve

Troubleshooting



Check No.12
Refer to P.169



Check No.15
Refer to P.171





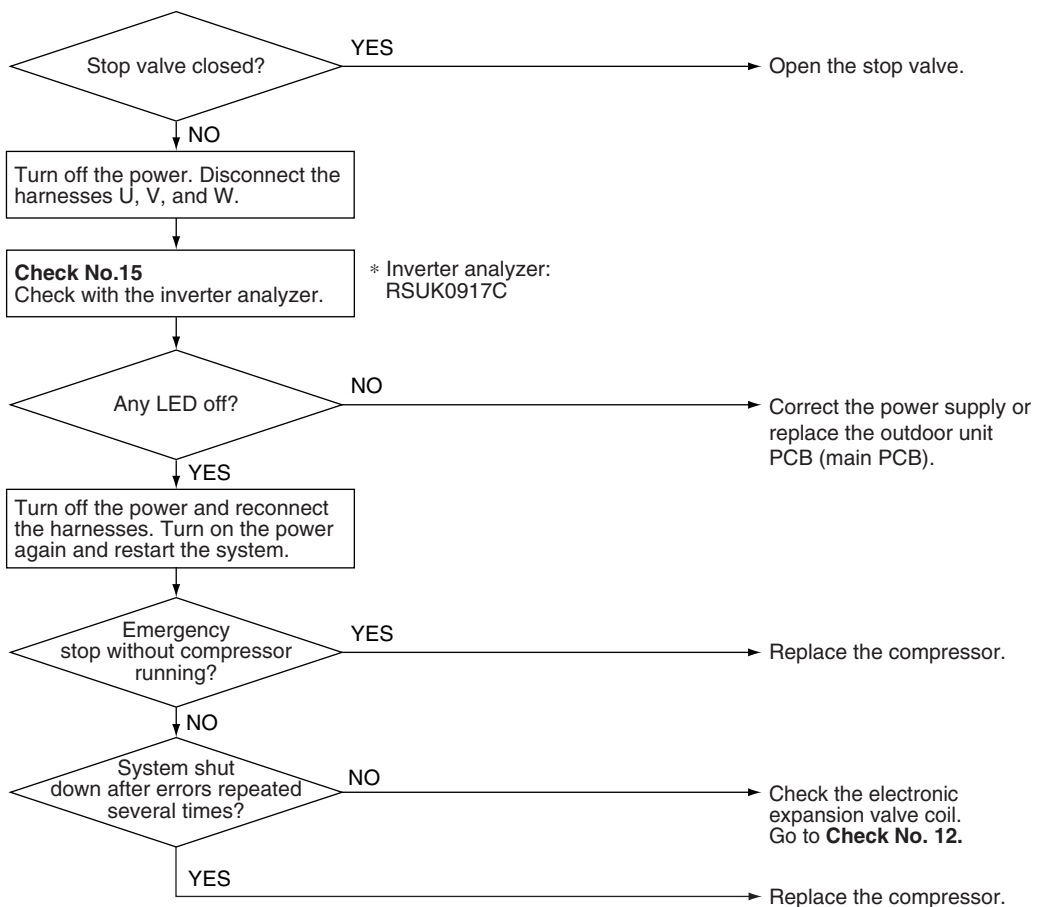

Caution

Be sure to turn off the power switch before connecting or disconnecting connectors, or parts may be damaged.
(Precaution before turning on the power again)
Make sure the power has been off for at least 30 seconds.



(R21067)

7.9 DC Fan Lock

Error Code	E7
Outdoor Unit LED Display	A  1  2  3  4  5 ●
Method of Error Detection	An error is determined with the high-voltage fan motor rotation speed detected by the Hall IC.
Error Decision Conditions	<ul style="list-style-type: none"> ■ The fan does not start in 30 seconds even when the fan motor is running. ■ If the error repeats, the system is shut down. ■ Reset condition: Continuous run for about 5 minutes without any other error
Supposed Causes	<ul style="list-style-type: none"> ■ Disconnection of the fan motor ■ Foreign matter stuck in the fan ■ Defective fan motor ■ Defective outdoor unit PCB

Troubleshooting

Check No.16
 Refer to P.172

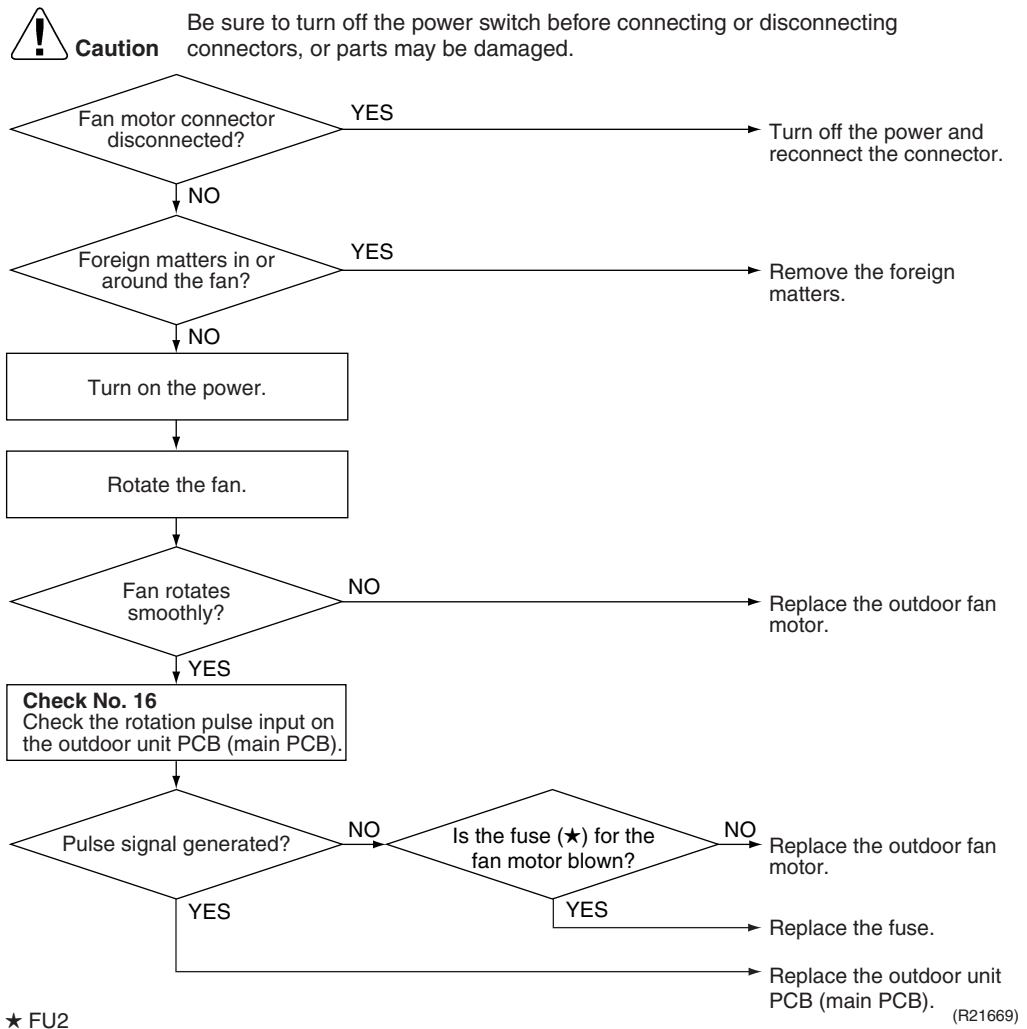

7.10 Input Overcurrent Detection

Error Code	E8
Outdoor Unit LED Display	A 1 ● 2 3 ● 4 5 ●
Method of Error Detection	Detected by checking the input current value
Error Decision Conditions	<ul style="list-style-type: none"> ■ The input current is at a certain value (depending on the condition) for 2.5 seconds. ■ The compressor halts if the error occurs, and restarts automatically after 3-minute standby.
Supposed Causes	<ul style="list-style-type: none"> ■ Outdoor temperature is out of operation range. ■ Defective compressor ■ Defective power module ■ Defective outdoor unit PCB ■ Short circuit

Troubleshooting

Check No.15
Refer to P.171

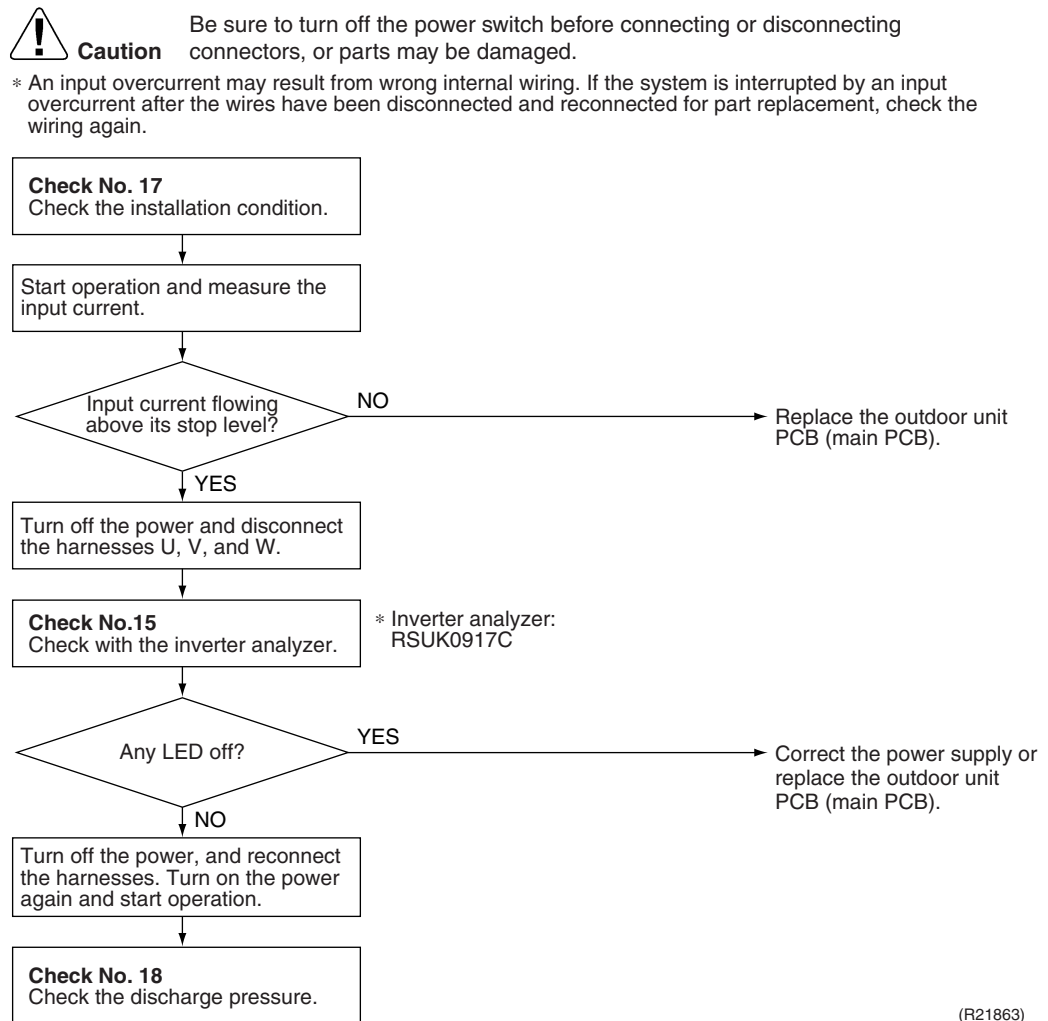

Check No.17
Refer to P.173

Check No.18
Refer to P.173



(R21863)

7.11 Four Way Valve Abnormality

Error Code	E8						
Outdoor Unit LED Display	A  1  2 ● 3 ● 4 ● 5 ●						
Method of Error Detection	The liquid pipe thermistor and the outdoor heat exchanger thermistor are checked to see if they function within their normal ranges in the operating mode.						
Error Decision Conditions	<p>A following condition continues for A seconds after the compressor has started.</p> <table border="1"> <thead> <tr> <th></th> <th>Cooling</th> <th>Heating</th> </tr> </thead> <tbody> <tr> <td>A (seconds)</td> <td>240</td> <td>1</td> </tr> </tbody> </table> <ul style="list-style-type: none"> ■ Cooling operation The lowest liquid pipe temperature among the rooms in operation –Tde > 45°C (81°F) ■ Heating operation The highest liquid pipe temperature among the rooms in operation –Tde < 0°C (0°F) <p>Tde: outdoor heat exchanger temperature</p>		Cooling	Heating	A (seconds)	240	1
	Cooling	Heating					
A (seconds)	240	1					
Supposed Causes	<ul style="list-style-type: none"> ■ Disconnection of four way valve coil ■ Defective four way valve, coil, or harness ■ Defective outdoor unit PCB ■ Defective thermistor ■ Refrigerant shortage ■ Water mixed in refrigerant ■ Defective stop valve 						

Troubleshooting



Check No.01
Refer to P.166



Check No.13
Refer to P.170



Check No.14
Refer to P.170



Caution Be sure to turn off the power switch before connecting or disconnecting connectors, or parts may be damaged.

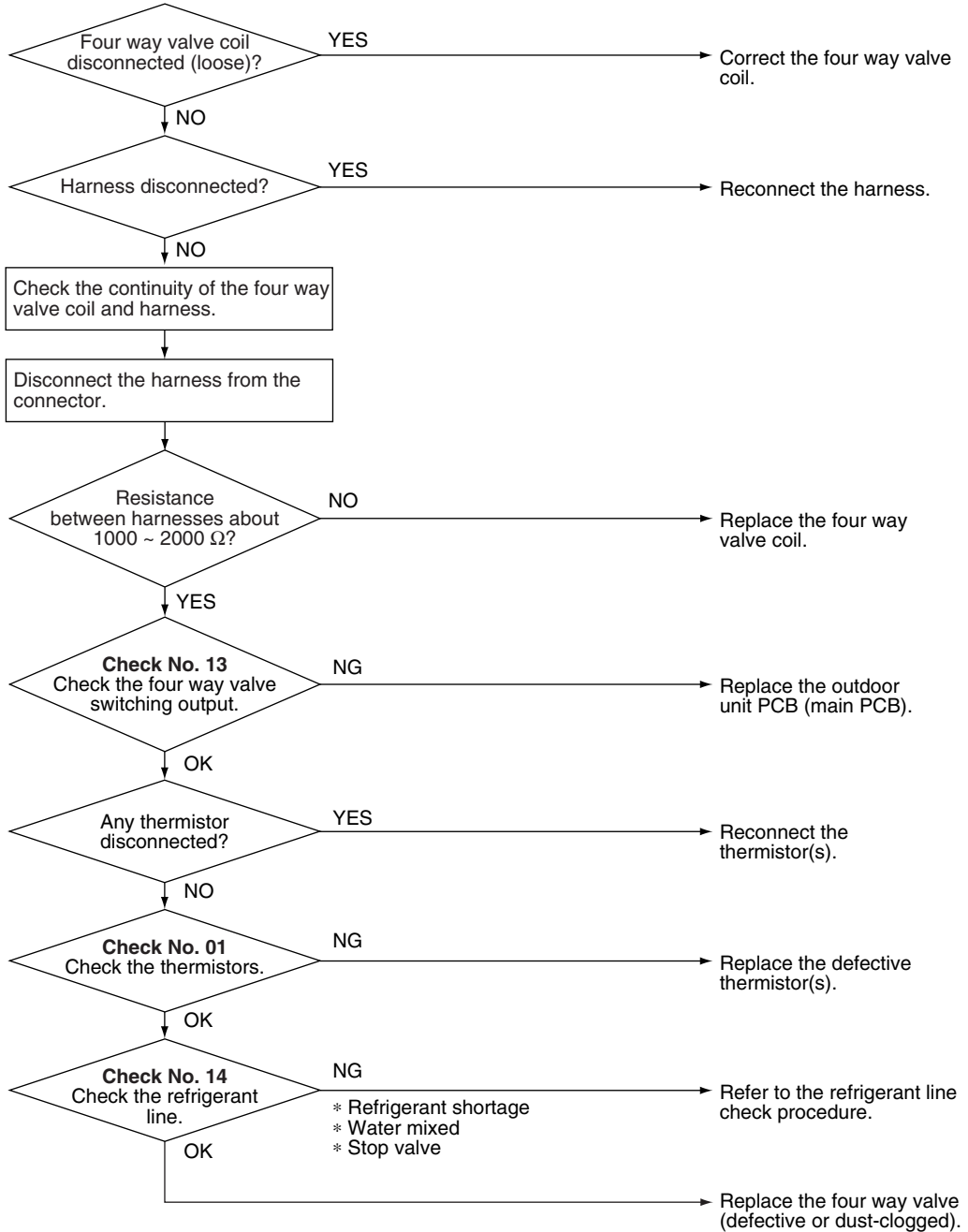

(R20405)

7.12 Discharge Pipe Temperature Control

Error Code	F3									
Outdoor Unit LED Display	A 1 2 3 4 5									
Method of Error Detection	An error is determined with the temperature detected by the discharge pipe thermistor.									
Error Decision Conditions	<ul style="list-style-type: none"> ■ If the temperature detected by the discharge pipe thermistor rises above A, the compressor stops. ■ The error is cleared when the discharge pipe temperature is dropped below B. <table border="1"> <thead> <tr> <th></th> <th>A</th> <th>B</th> </tr> </thead> <tbody> <tr> <td>18 class</td> <td>120°C (248°F)</td> <td>95°C (203°F)</td> </tr> <tr> <td>24/36 class</td> <td>120°C (248°F)</td> <td>107°C (224.6°F)</td> </tr> </tbody> </table> <ul style="list-style-type: none"> ■ If the error repeats, the system is shut down. ■ Reset condition: Continuous run for about 60 minutes without any other error 		A	B	18 class	120°C (248°F)	95°C (203°F)	24/36 class	120°C (248°F)	107°C (224.6°F)
	A	B								
18 class	120°C (248°F)	95°C (203°F)								
24/36 class	120°C (248°F)	107°C (224.6°F)								
Supposed Causes	<ul style="list-style-type: none"> ■ Defective discharge pipe thermistor (Defective outdoor heat exchanger thermistor or outdoor temperature thermistor) ■ Defective electronic expansion valve or coil ■ Refrigerant shortage ■ Defective four way valve ■ Water mixed in refrigerant ■ Defective stop valve ■ Defective outdoor unit PCB 									

Troubleshooting

- Check No.01**
Refer to P.166
- Check No.12**
Refer to P.169
- Check No.14**
Refer to P.170

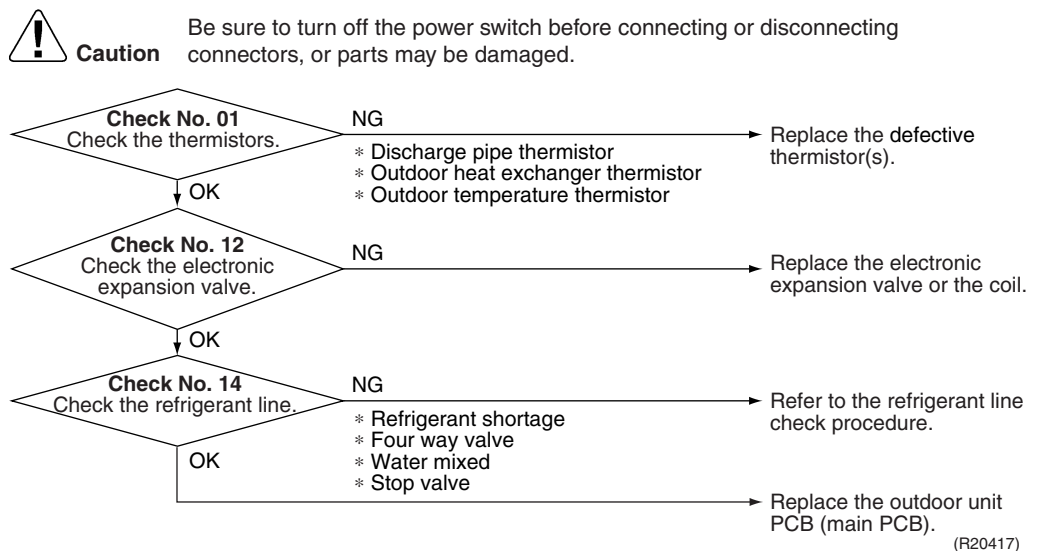

7.13 High Pressure Control in Cooling

Error Code	F6
Outdoor Unit LED Display	A 1 2 3 4 5
Method of Error Detection	High pressure control (operation halt, frequency drop, etc.) is activated in cooling operation if the temperature sensed by the outdoor heat exchanger thermistor exceeds the limit.
Error Decision Conditions	<ul style="list-style-type: none"> ■ The temperature sensed by the outdoor heat exchanger thermistor rises above about 65°C (149°F). ■ The error is cleared when the temperature drops below about 49.5°C (121.1°F).
Supposed Causes	<ul style="list-style-type: none"> ■ The installation space is not large enough. ■ Dirty outdoor heat exchanger ■ Defective outdoor fan motor ■ Defective stop valve ■ Defective electronic expansion valve or coil ■ Defective outdoor heat exchanger thermistor ■ Defective outdoor unit PCB



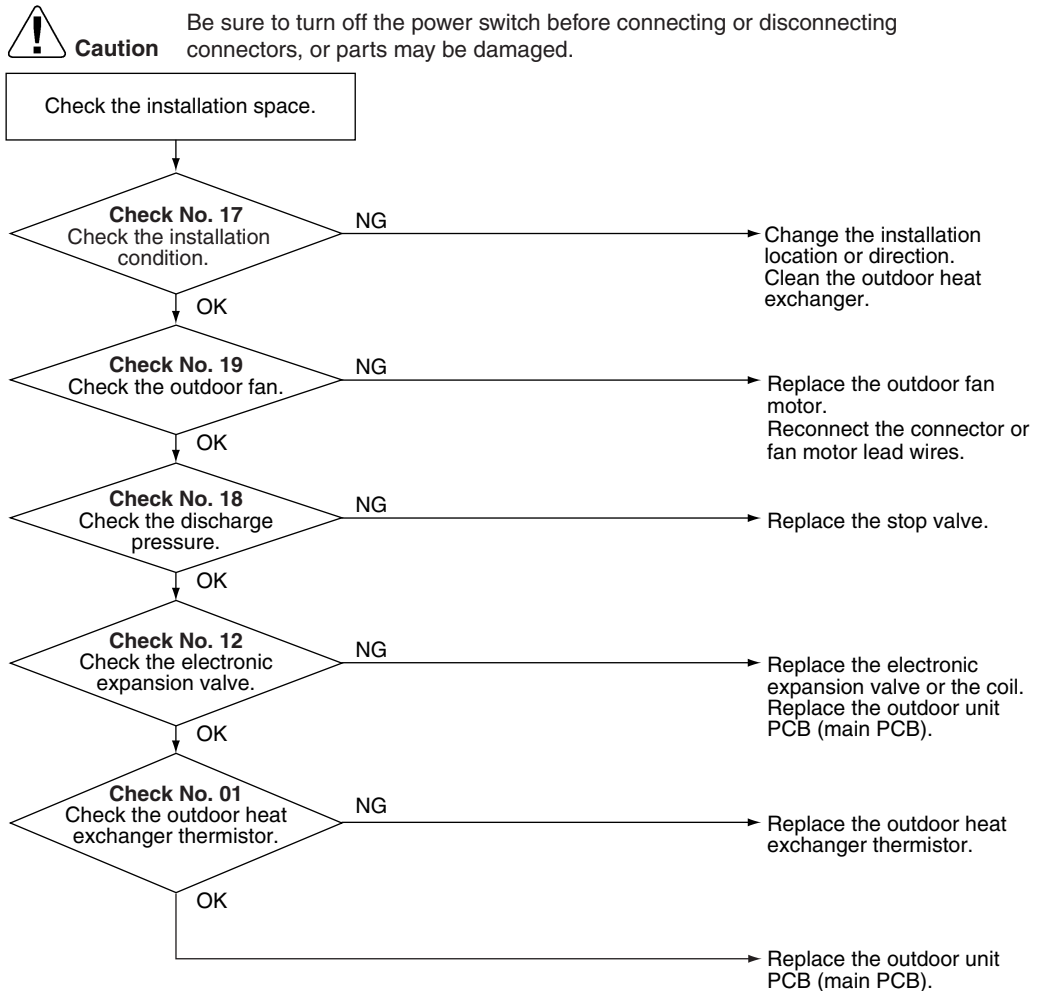

Troubleshooting

- Check No.01**
Refer to P.166
- Check No.12**
Refer to P.169
- Check No.17**
Refer to P.173
- Check No.18**
Refer to P.173
- Check No.19**
Refer to P.174



(R20418)

7.14 Compressor Sensor System Abnormality

Error Code	H0
Outdoor Unit LED Display	A  1  2  3  4  5
Method of Error Detection	<ul style="list-style-type: none"> ■ The system checks the power supply voltage and the DC voltage before the compressor starts. ■ The system checks the DC current of the compressor right after the compressor starts.

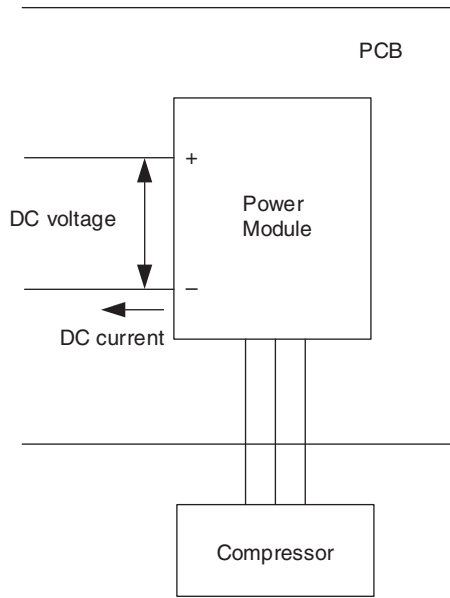

(R22001)



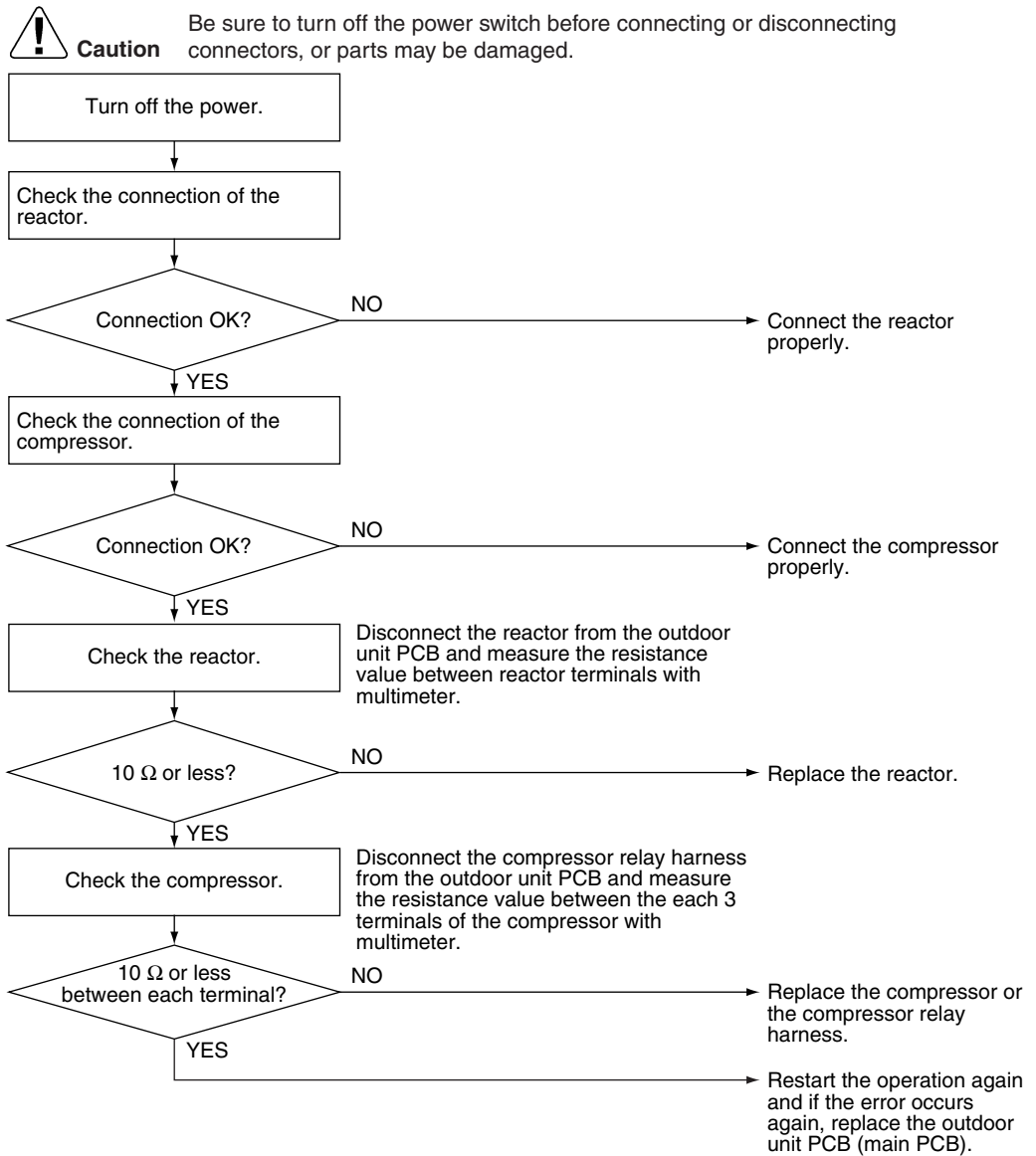

Error Decision Conditions	<ul style="list-style-type: none"> ■ The power supply voltage and the DC voltage is obviously low or high. ■ The DC current of the compressor does not flow when the compressor starts.
Supposed Causes	<ul style="list-style-type: none"> ■ Disconnection of reactor ■ Disconnection of compressor harness ■ Defective outdoor unit PCB ■ Defective compressor

Troubleshooting



(R20419)

7.15 Position Sensor Abnormality

Error Code	H6
Outdoor Unit LED Display	A  1  2  3  4  5
Method of Error Detection	A compressor start-up failure is detected by checking the compressor running condition through the position detection circuit.
Error Decision Conditions	<ul style="list-style-type: none"> ■ If the error repeats, the system is shut down. ■ Reset condition: Continuous run for about 5 minutes without any other error
Supposed Causes	<ul style="list-style-type: none"> ■ Power supply voltage is not as specified. ■ Disconnection of the compressor harness ■ Defective compressor ■ Defective outdoor unit PCB ■ Start-up failure caused by the closed stop valve ■ Input voltage is outside the specified range.

Troubleshooting

 **Check No.15**
Refer to P.171

 **Check No.18**
Refer to P.173



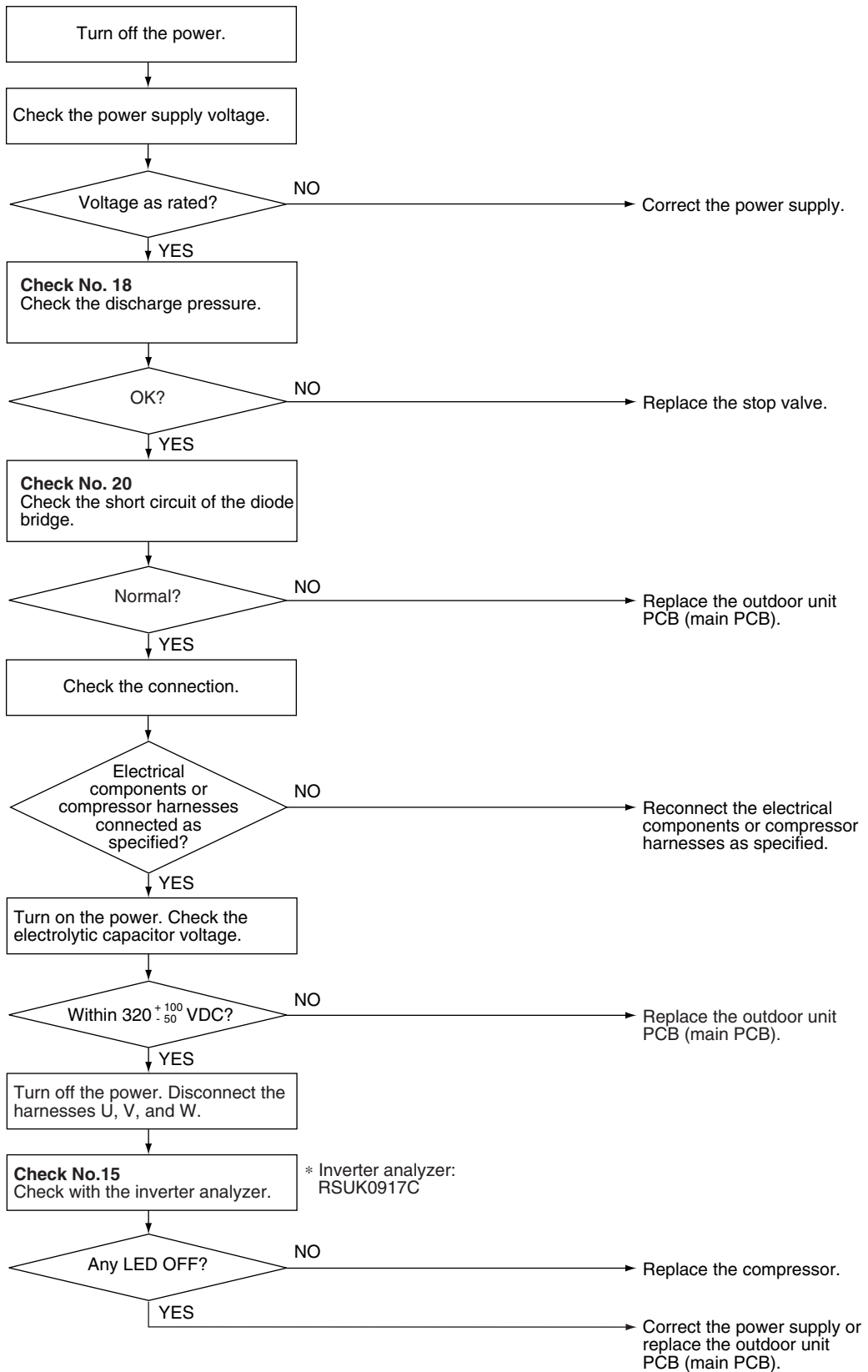

 **Check No.20**
Refer to P.174

 **Caution** Be sure to turn off the power switch before connecting or disconnecting connectors, or parts may be damaged.



(R22270)

7.16 CT or Related Abnormality

Error Code	H8									
Outdoor Unit LED Display	A  1  2  3  4  5									
Method of Error Detection	A CT or related error is detected by checking the compressor running frequency and CT-detected input current.									
Error Decision Conditions	<ul style="list-style-type: none"> ■ The compressor running frequency is more than A Hz and input current is less than B A. <table border="1"> <thead> <tr> <th></th> <th>A (Hz)</th> <th>B (A)</th> </tr> </thead> <tbody> <tr> <td>18/24 class</td> <td>32</td> <td>0.5</td> </tr> <tr> <td>36 class</td> <td>55</td> <td>0.5</td> </tr> </tbody> </table> <ul style="list-style-type: none"> ■ If the error repeats, the system is shut down. ■ Reset condition: Continuous run for about 60 minutes without any other error 		A (Hz)	B (A)	18/24 class	32	0.5	36 class	55	0.5
	A (Hz)	B (A)								
18/24 class	32	0.5								
36 class	55	0.5								
Supposed Causes	<ul style="list-style-type: none"> ■ Defective power module ■ Broken or disconnected wiring ■ Defective reactor ■ Defective outdoor unit PCB 									

Troubleshooting



Check No.15
Refer to P.171



Check No.21
Refer to P.175



Caution

Be sure to turn off the power switch before connecting or disconnecting connectors, or parts may be damaged.

Turn off the power. Then, turn on the power to restart the system.

Start operation.

* Running current as shown at right with relay cable 1 or 2?

YES

Replace the outdoor unit PCB (main PCB).

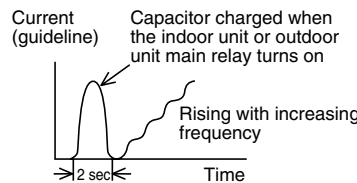

NO

Check No. 21
Check the capacitor voltage.

Within $320 + \frac{100}{50}$ VDC?

YES

Turn off the power. Disconnect the harnesses U, V, and W.

Check No.15
Check with the inverter analyzer.

* Inverter analyzer: RSUK0917C

Any LED OFF?

YES

Correct the power supply or replace the outdoor unit PCB (main PCB).

NO

Turn off the power and reconnect the harnesses. Then turn on the power again and restart operation.

Compressor running?

NO

Replace the compressor.

YES

Replace the outdoor unit PCB (main PCB).

Measure the rectifier input voltage.

Voltage within the allowable range (Power supply voltage $\pm 15\%$)?

NO







Check the power supply voltage.

YES

Replace the outdoor unit PCB (main PCB).

(R22271)

7.17 Thermistor or Related Abnormality (Outdoor Unit)

Error Code	<i>H3, U3, U6, U8, U9, P4</i>
Outdoor Unit LED Display	A  1  2  3  4  5
Method of Error Detection	This fault is identified based on the thermistor input voltage to the microcomputer. A thermistor fault is identified based on the temperature sensed by each thermistor.
Error Decision Conditions	<ul style="list-style-type: none"> ■ The voltage between the both ends of the thermistor is above 4.96 V or below 0.04 V with the power on. ■ <i>U3</i> error is judged if the discharge pipe temperature is lower than the heat exchanger temperature. ■ The system is shut down if all the units are judged as the <i>U3</i> error.
Supposed Causes	<ul style="list-style-type: none"> ■ Disconnection of the connector for the thermistor ■ Thermistor corresponding to the error code is defective. ■ Defective heat exchanger thermistor in the case of <i>U3</i> error (outdoor heat exchanger thermistor in cooling operation, or indoor heat exchanger thermistor in heating operation) ■ Defective outdoor unit PCB
Troubleshooting	<p>In case of <i>P4</i></p> <p> Caution Be sure to turn off the power switch before connecting or disconnecting connectors, or parts may be damaged.</p> <p>Replace the outdoor unit PCB (main PCB).</p> <p><i>P4</i> : Radiation fin thermistor</p>

Troubleshooting

In case of *H9, J3, J5, J8, J9*

Check No.01
 Refer to P.166



Caution

Be sure to turn off the power switch before connecting or disconnecting connectors, or parts may be damaged.

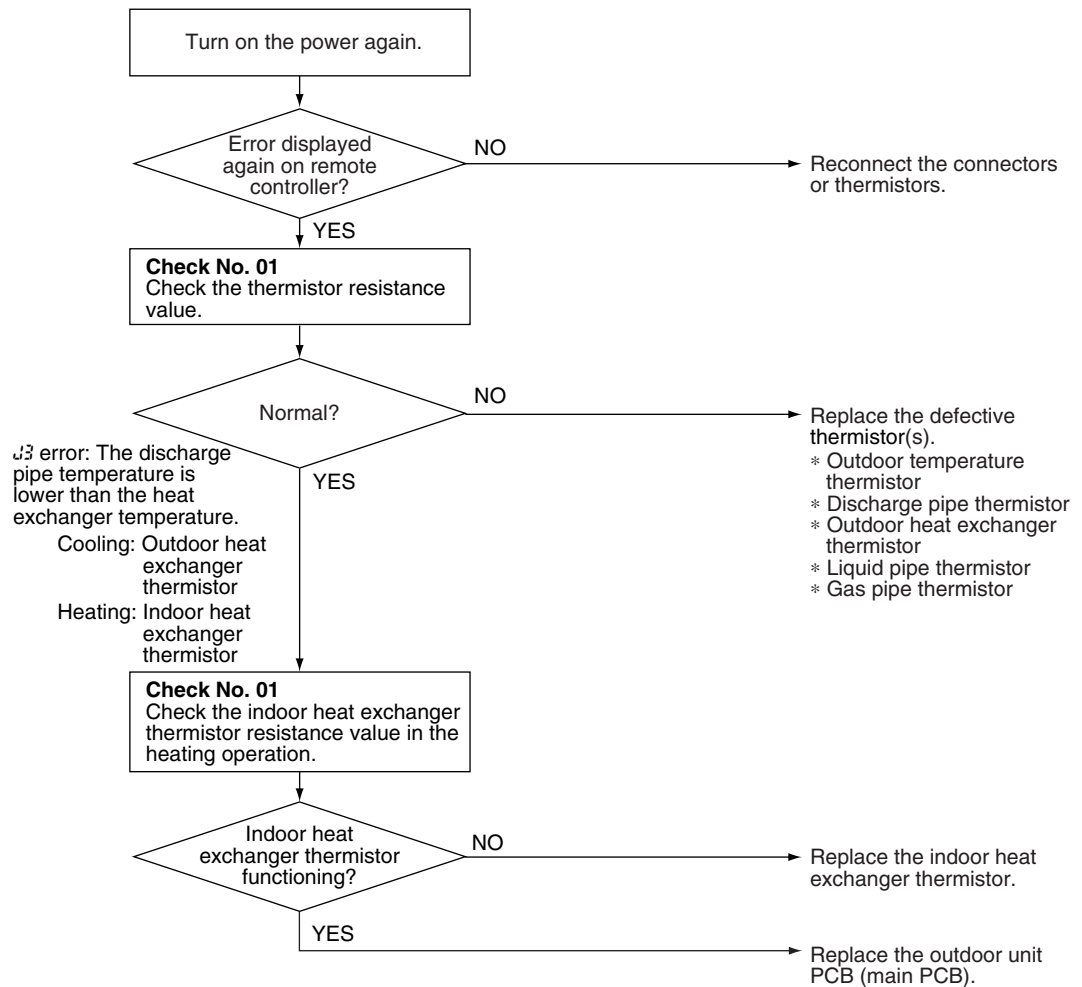

J3 error: The discharge pipe temperature is lower than the heat exchanger temperature.

Cooling: Outdoor heat exchanger thermistor
 Heating: Indoor heat exchanger thermistor

(R21118)

- H9* : Outdoor temperature thermistor
- J3* : Discharge pipe thermistor
- J5* : Outdoor heat exchanger thermistor
- J8* : Liquid pipe thermistor
- J9* : Gas pipe thermistor

7.18 Electrical Box Temperature Rise

Error Code	L3						
Outdoor Unit LED Display	A ● 1 ☉ 2 ☉ 3 ● 4 ☉ 5 ●						
Method of Error Detection	An electrical box temperature rise is detected by checking the radiation fin thermistor with the compressor off.						
Error Decision Conditions	<ul style="list-style-type: none"> ■ With the compressor off, the radiation fin temperature is above A. ■ The error is cleared when the temperature drops below B. ■ To cool the electrical components, the outdoor fan starts when the radiation fin temperature rises above C and stops when it drops below B. 						
	<table border="1"> <thead> <tr> <th>A</th> <th>B</th> <th>C</th> </tr> </thead> <tbody> <tr> <td>100°C (212°F)</td> <td>70°C (158°F)</td> <td>85°C (185°F)</td> </tr> </tbody> </table>	A	B	C	100°C (212°F)	70°C (158°F)	85°C (185°F)
A	B	C					
100°C (212°F)	70°C (158°F)	85°C (185°F)					
Supposed Causes	<ul style="list-style-type: none"> ■ Defective outdoor fan motor ■ Short circuit ■ Defective radiation fin thermistor ■ Disconnection of connector ■ Defective outdoor unit PCB 						

Troubleshooting

Check No.17
 Refer to P.173

Check No.19
 Refer to P.174

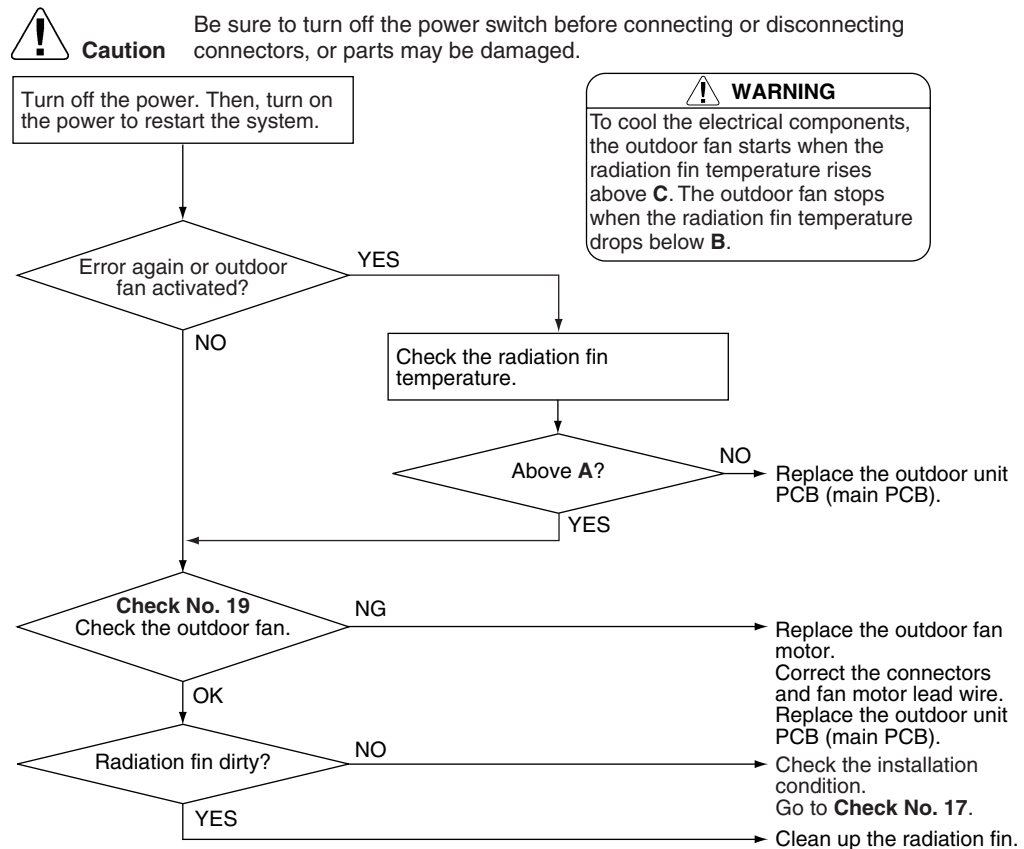

(R22272)

7.19 Radiation Fin Temperature Rise

Error Code	L4				
Outdoor Unit LED Display	A 1 ● 2 ● 3 ● 4 5 ●				
Method of Error Detection	A radiation fin temperature rise is detected by checking the radiation fin temperature with the compressor on.				
Error Decision Conditions	<ul style="list-style-type: none"> ■ The radiation fin temperature with the compressor on is above A. ■ The error is cleared when the temperature drops below B. <table border="1"> <thead> <tr> <th>A</th> <th>B</th> </tr> </thead> <tbody> <tr> <td>90°C (194°F)</td> <td>85°C (185°F)</td> </tr> </tbody> </table> <ul style="list-style-type: none"> ■ If the error repeats, the system is shut down. ■ Reset condition: Continuous run for about 60 minutes without any other error 	A	B	90°C (194°F)	85°C (185°F)
A	B				
90°C (194°F)	85°C (185°F)				
Supposed Causes	<ul style="list-style-type: none"> ■ Defective outdoor fan motor ■ Short circuit ■ Defective radiation fin thermistor ■ Disconnection of connector ■ Defective outdoor unit PCB ■ Silicon grease is not applied properly on the radiation fin after replacing the outdoor unit PCB. 				

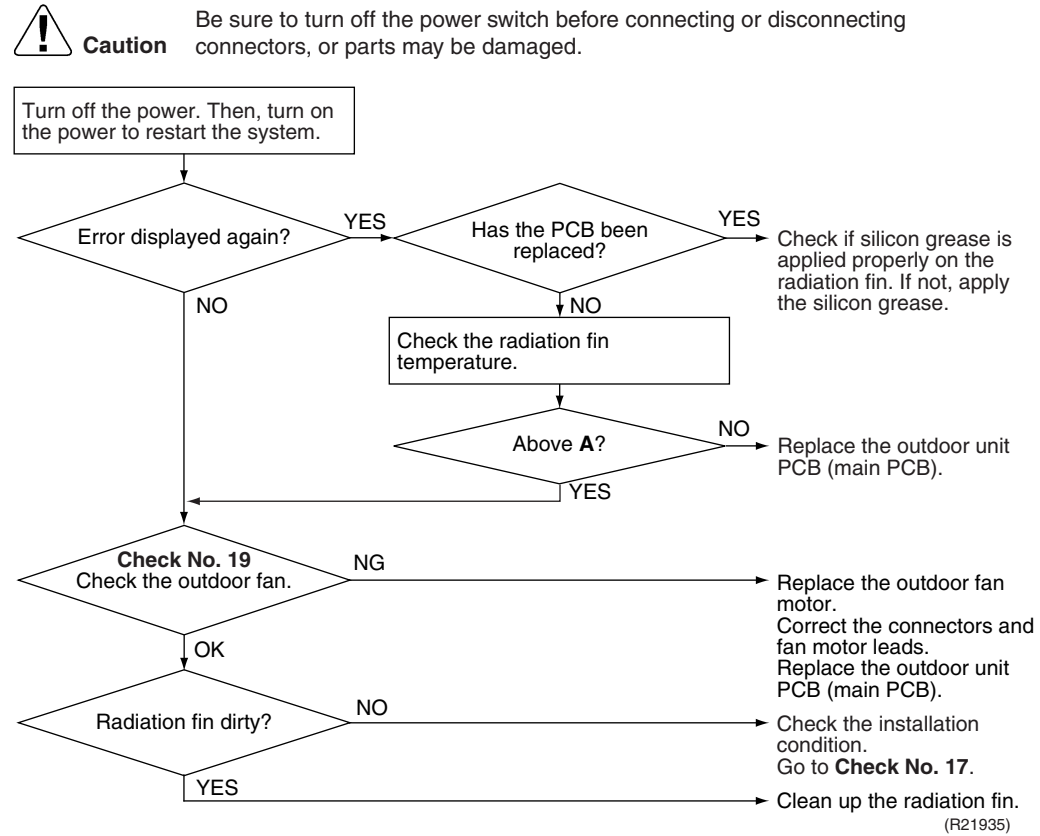

Troubleshooting

- Check No.17**
Refer to P.173
- Check No.19**
Refer to P.174



Note: Refer to Silicon Grease on Power Transistor / Diode Bridge on page 199 for detail. (R21935)

7.20 Output Overcurrent Detection

Error Code	U5
Outdoor Unit LED Display	A  1 ● 2 ● 3  4 ● 5 ●
Method of Error Detection	An output overcurrent is detected by checking the current that flows in the inverter DC section.
Error Decision Conditions	<ul style="list-style-type: none"> ■ A position signal error occurs while the compressor is running. ■ A rotation speed error occurs while the compressor is running. ■ An output overcurrent signal is fed from the output overcurrent detection circuit to the microcomputer. ■ If the error repeats, the system is shut down. ■ Reset condition: Continuous run for about 5 minutes without any other error
Supposed Causes	<ul style="list-style-type: none"> ■ Poor installation condition ■ Closed stop valve ■ Defective power module ■ Wrong internal wiring ■ Abnormal power supply voltage ■ Defective outdoor unit PCB ■ Supply voltage is not as specified. ■ Defective compressor

Troubleshooting



Check No.15
Refer to P.171



Check No.17
Refer to P.173



Check No.18
Refer to P.173



Check No.22
Refer to P.176



Caution Be sure to turn off the power switch before connecting or disconnecting connectors, or parts may be damaged.

* An output overcurrent may result from wrong internal wiring. If the system is interrupted by an output overcurrent after the wires have been disconnected and reconnected for part replacement, check the wiring again.

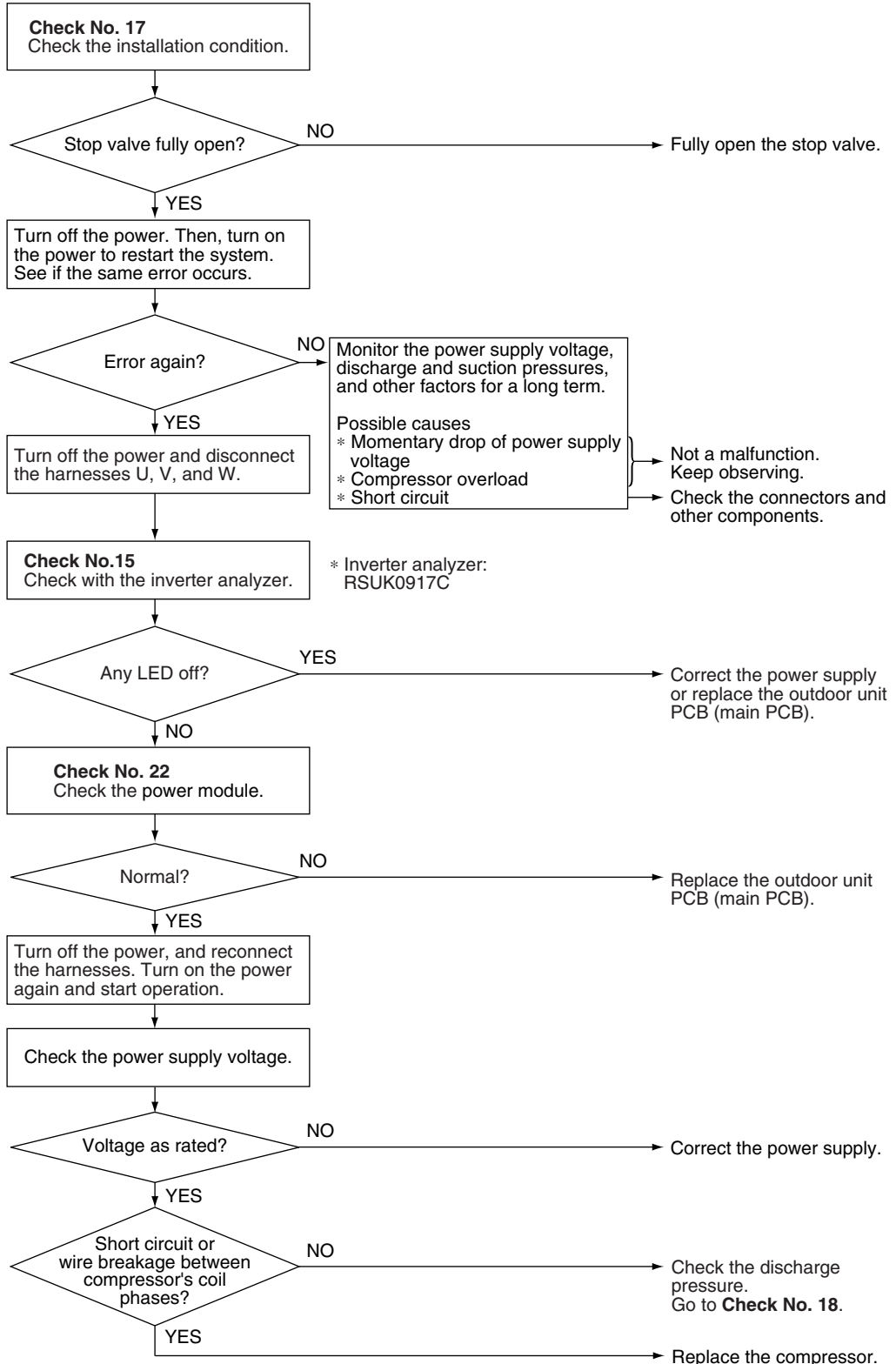

(R21438)

8. Check

8.1 Thermistor Resistance Check

Check No.01

Disconnect the connectors of the thermistors from the PCB, and measure the resistance of each thermistor using multimeter.

The data is for reference purpose only.

Thermistor temperature		Resistance (k Ω)
$^{\circ}\text{C}$	$^{\circ}\text{F}$	
-20	-4	197.8
-15	5	148.2
-10	14	112.1
-5	23	85.60
0	32	65.93
5	41	51.14
10	50	39.99
15	59	31.52
20	68	25.02
25	77	20.00
30	86	16.10
35	95	13.04
40	104	10.62
45	113	8.707
50	122	7.176

(R25 $^{\circ}\text{C}$ (77 $^{\circ}\text{F}$) = 20 k Ω , B = 3950 K)

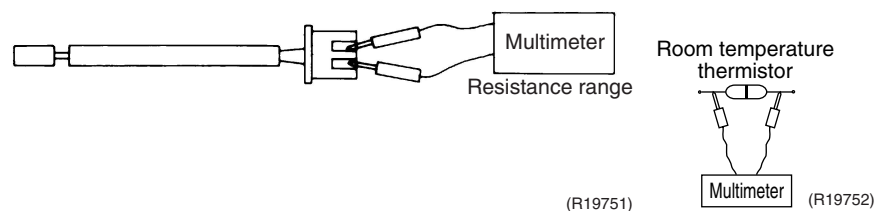
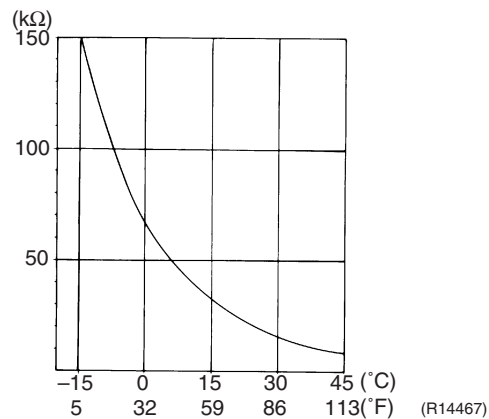

- When the room temperature thermistor is soldered on a PCB, remove the PCB from the control PCB to measure the resistance.
- When the connector of indoor heat exchanger thermistor is soldered on a PCB, remove the thermistor and measure the resistance.

8.2 Indoor Fan Motor Connector Check

Check No.02

CTXS, FTXS, FVXS Series

1. Check the connection of connector.
2. Check motor power supply voltage output (pins 4 - 7).
3. Check motor control voltage (pins 4 - 3).
4. Check rotation command voltage output (pins 4 - 2).
5. Check rotation pulse input (pins 4 - 1).

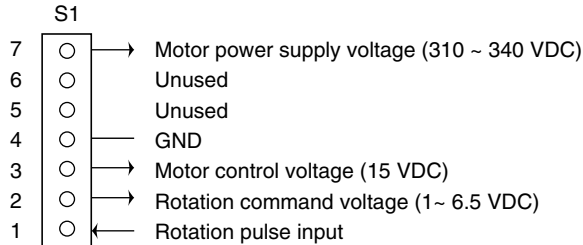

(R19654)

8.3 Hall IC Check

Check No.04

CDXS, FDXS Series

1. Check the connector connection.
2. With the power on, operation off, and the connector connected, check the following.
 - (1) Output voltage of about 5 V between pins 1 and 3.
 - (2) Generation of 3 pulses between pins 2 and 3 when the indoor fan motor is operating.

If NG in step (1) → Defective PCB → Replace the PCB (control PCB).

If NG in step (2) → Defective Hall IC → Replace the indoor fan motor.

If OK in both steps (1) and (2) → Replace the PCB (control PCB).

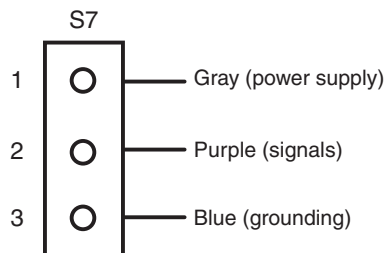

(R14211)

8.4 Power Supply Waveform Check

Check No.11

Measure the power supply waveform between No. 1 and No. 2 on the terminal board, and check the waveform disturbance.

- Check if the power supply waveform is a sine wave (Fig.1).
- Check if there is waveform disturbance near the zero-cross (sections circled in Fig.2)

[Fig.1]

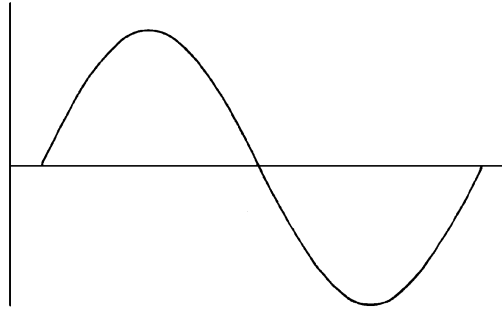

[Fig.2]

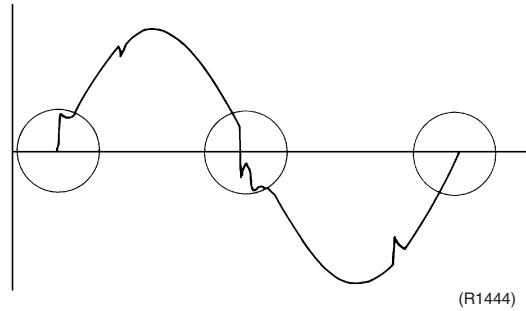

8.5 Electronic Expansion Valve Check

Check No.12

Conduct the followings to check the electronic expansion valve (EV).

1. Check if the EV connector is correctly inserted in the PCB. Match the EV unit number and the connector number.
2. Turn the power off and on again, and check if all the EVs generate a latching sound.
3. If any of the EVs does not generate a latching sound in the above step 2, disconnect that connector and check the continuity using a multimeter.
Check the continuity between the pins 1 - 6, 3 - 6, 2 - 5, 4 - 5 (between the pins 1 - 5, 2 - 5, 3 - 5, 4 - 5 for the harness 5P models). If there is no continuity between the pins, the EV coil is faulty.
4. If no EV generates a latching sound in the above step 2, the outdoor unit PCB is faulty.
5. If the continuity is confirmed in the above step 3, mount a good coil (which generated a latching sound) in the EV unit that did not generate a latching sound, and check if that EV generates a latching sound.
*If a latching sound is generated, the outdoor unit PCB is faulty.
*If a latching sound is not generated, the EV unit is faulty.



Note: Please note that the latching sound varies depending on the valve type.

If the system keeps operating with a defective electronic expansion valve, the following problem may occur.

Valve opening position	Possible problem	Check method
Open	<p>Cooling:</p> <ul style="list-style-type: none"> ■ Flowing noise of refrigerant in the unit which is not in operation ■ Water leakage at the unit which is not in operation ■ Operation half due to anti-icing function <p>Heating:</p> <ul style="list-style-type: none"> ■ Flowing noise of refrigerant in the unit which is not in operation ■ The unit does not heat the room. 	<p>Reset power supply and conduct cooling operation unit by unit.</p> <p>Check the liquid pipe temperature of no-operation unit.</p> <p>Almost the same as the outdoor temperature?</p> <p>NO → The EV is not defective.</p> <p>YES → Replace the EV of the room. (R16019)</p>
Close	<p>Cooling:</p> <ul style="list-style-type: none"> ■ The problem unit does not cool the room. ■ Only the problem unit is in operation, the unit starts pump down. (The low pressure of the unit becomes vacuum.) ■ Abnormal discharge pipe temperature <p>Heating:</p> <ul style="list-style-type: none"> ■ Refrigerant shortage due to stagnation of liquid refrigerant inside the faulty indoor unit ■ The unit does not heat the room. ■ Abnormal discharge pipe temperature 	<p>Reset power supply and conduct cooling operation unit by unit.</p> <p>Check the low pressure.</p> <p>Does the pressure become into vacuum zone?</p> <p>NO → The EV is not defective.</p> <p>YES → Replace the EV of the room. (R16020)</p>

8.6 Four Way Valve Performance Check

Check No.13

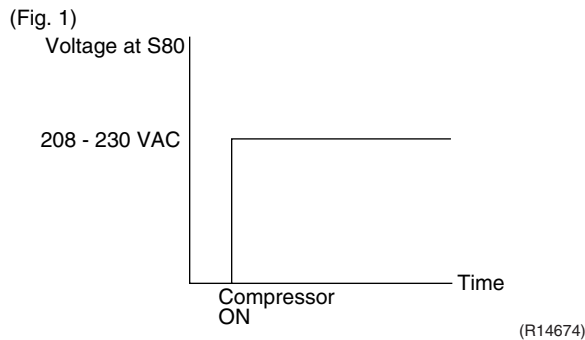
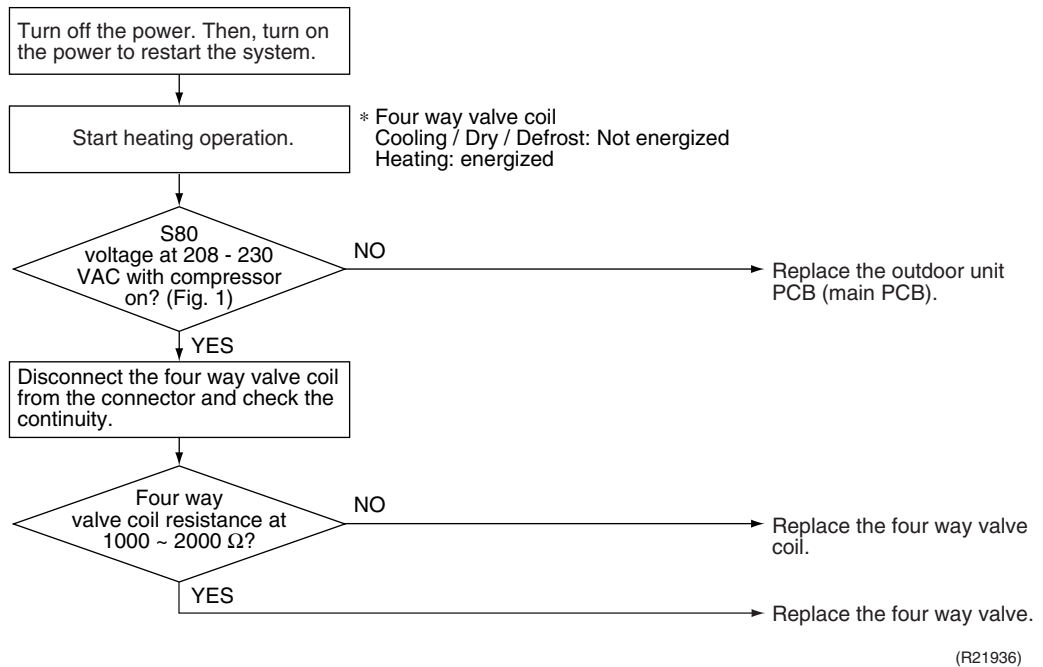

8.7 Inverter Unit Refrigerant System Check

Check No.14

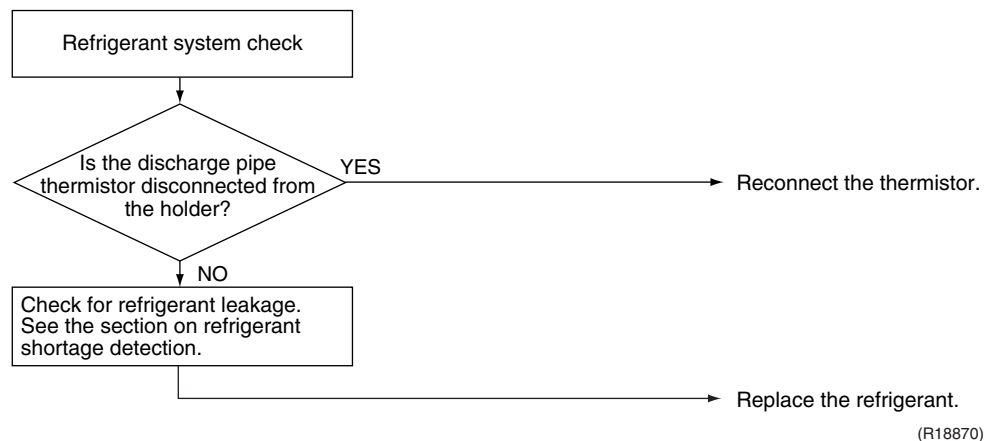

8.8 Inverter Analyzer Check

Check No.15

■ Characteristics

Inverter analyzer: RSUK0917C

If an abnormal stop occurs due to compressor startup failure or overcurrent output when using an inverter unit, it is difficult to judge whether the stop is caused by the compressor failure or some other failure (main PCB, power module, etc.). The inverter analyzer makes it possible to judge the cause of trouble easily and securely. (Connect an inverter analyzer as a quasi-compressor instead of compressor and check the output of the inverter)

■ Operation Method

Step 1

Be sure to turn the power off.

Step 2

Install an inverter analyzer instead of a compressor.

Note:

Make sure the charged voltage of the built-in smoothing electrolytic capacitor drops to 10 VDC or below before carrying out the service work.

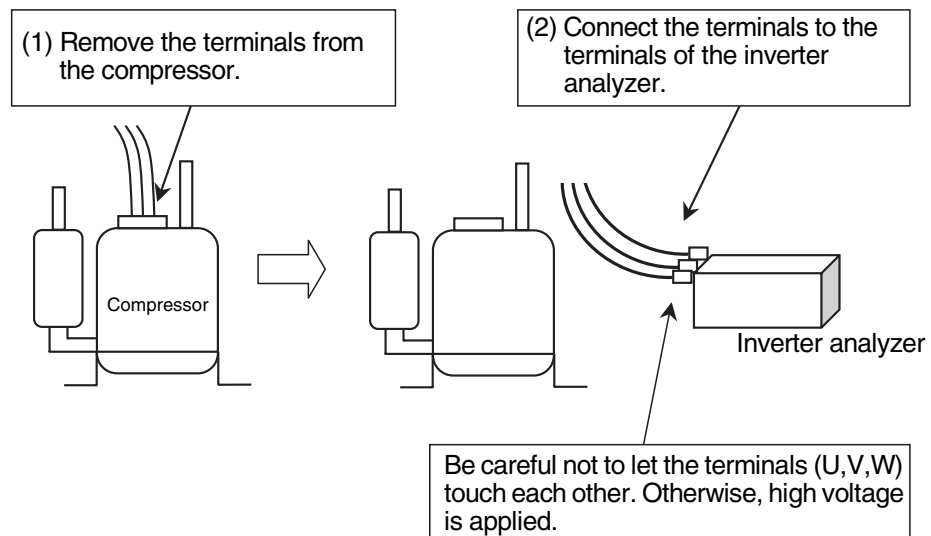

(R18322)

Reference:

If the terminals of the compressor are not FASTON terminals (difficult to remove the wire on the terminals), it is possible to connect wires available on site to the outdoor unit from output side of PCB. (Do not connect them to the compressor at the same time, otherwise it may result in incorrect detection.)

Step 3

Activate the power transistor test operation from the outdoor unit.

1) Press the forced cooling operation ON/OFF switch for 5 seconds.

(Refer to page 178 for the position.)

→ Power transistor test operation starts.

■ **Diagnose method (Diagnose according to 6 LEDs lighting status.)**

- (1) If all the LEDs are lit uniformly, the compressor is defective.
→ Replace the compressor.
- (2) If the LEDs are not lit uniformly, check the power module.
→ Refer to **Check No.22**.
- (3) If NG in **Check No.22**, replace the power module.
(Replace the main PCB. The power module (IPM1) is united with the main PCB.)
If OK in **Check No.22**, check if there is any solder cracking on the PCB.
- (4) If any solder cracking is found, replace the PCB or repair the soldered section.
If there is no solder cracking, replace the PCB.



Caution

- (1) When the output frequency is low, the LEDs blink slowly. As the output frequency increases, the LEDs blink quicker. (The LEDs look like they are lit.)
- (2) On completion of the inverter analyzer diagnosis, be sure to re-crip the FASTON terminals. Otherwise, the terminals may be burned due to loosening.

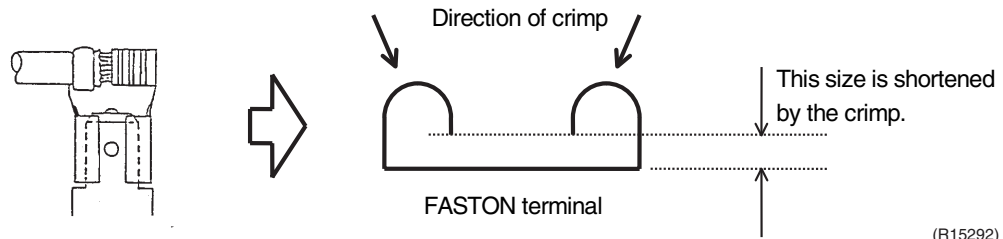

(R15292)

8.9 Rotation Pulse Check on the Outdoor Unit PCB

Check No.16

<Outdoor fan motor>

Make sure that the voltage of $320 \pm_{50}^{100}$ V is applied.

1. Set operation off and power off. Disconnect the connector S70.
2. Check that the voltage between the pins 4 - 7 is 320 VDC.
3. Check that the control voltage between the pins 3 - 4 is 15 VDC.
4. Check that the rotation command voltage between the pins 2 - 4 is 0 ~ 15 VDC.
5. Keep operation off and power off. Connect the connector S70.
6. Check whether 4 pulses (0 ~ 15 VDC) are input at the pins 1 - 4 when the outdoor fan motor is rotated 1 turn by hand.

When the fuse is melted, check the outdoor fan motor for proper function.

If NG in step 2 → Defective PCB → Replace the outdoor unit PCB (main PCB).

If NG in step 4 → Defective Hall IC → Replace the outdoor fan motor.

If OK in both steps 2 and 4 → Replace the outdoor unit PCB (main PCB).

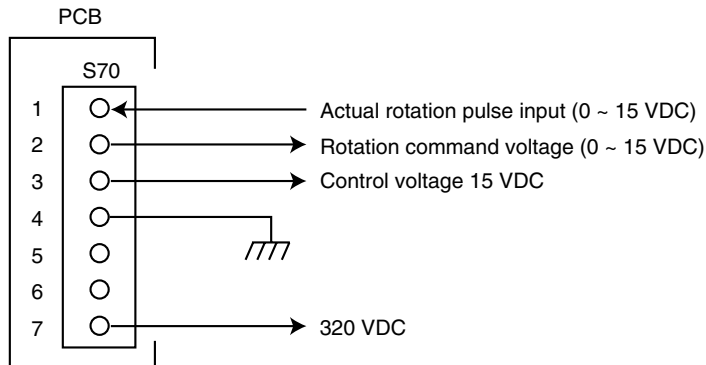

(R21120)

8.10 Installation Condition Check

Check No.17

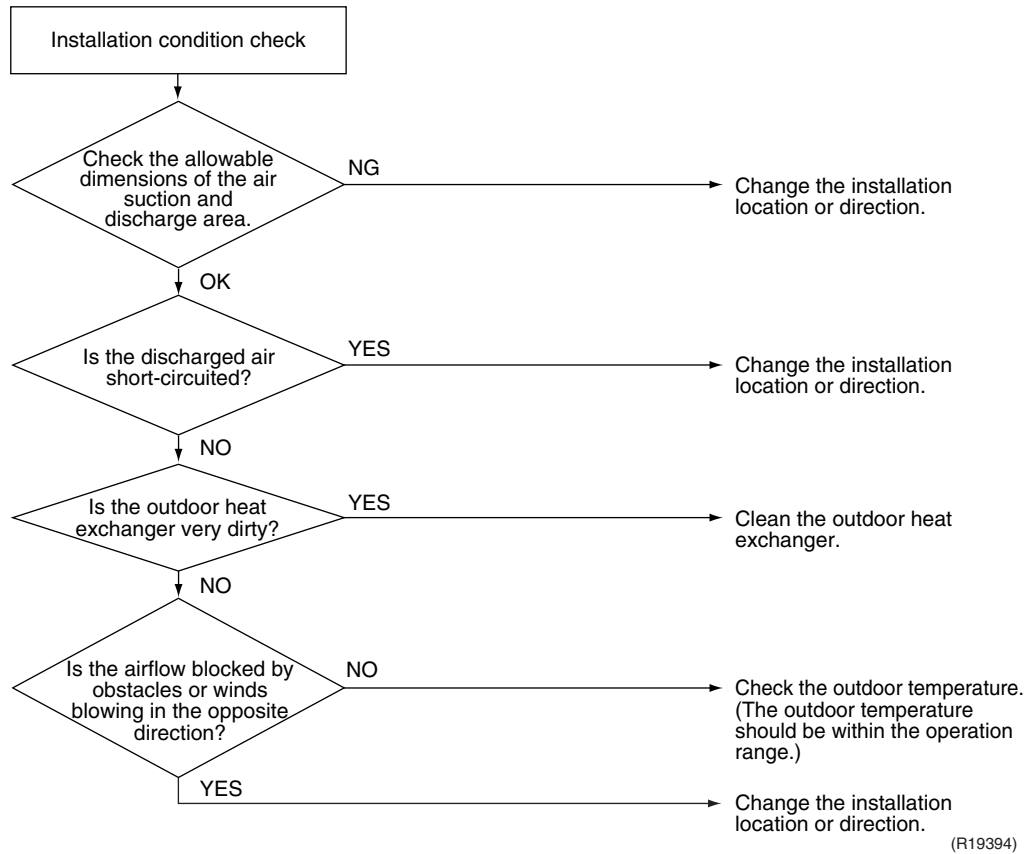

8.11 Discharge Pressure Check

Check No.18

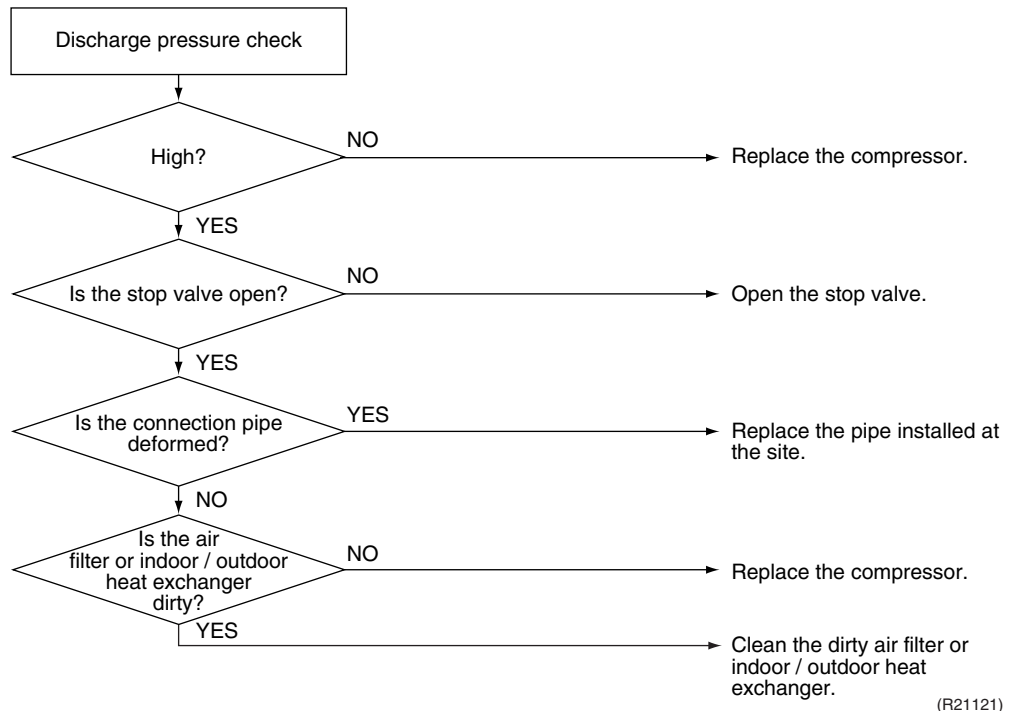

8.12 Outdoor Fan System Check

Check No.19

DC motor

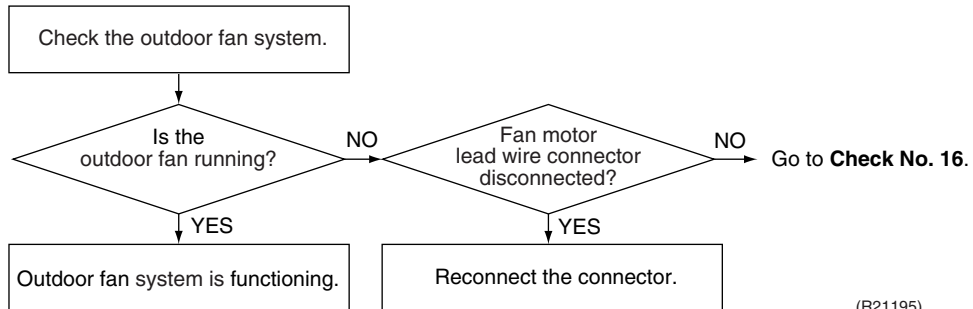

(R21195)

8.13 Main Circuit Short Check

Check No.20

Check to make sure that the voltage between (+) and (-) of the diode bridge (DB1) is about 0 V before checking

- Measure the resistance between the pins of the DB1 referring to the table below.
- If the resistance is ∞ or less than 1 k Ω , short circuit occurs on the main circuit.

Positive terminal (+) of digital multimeter	~ (2, 3)	+ (4)	~ (2, 3)	- (1)
Negative terminal (-) of digital multimeter	+ (4)	~ (2, 3)	- (1)	~ (2, 3)
Resistance is OK.	several k Ω ~ several M Ω			
Resistance is NG.	0 Ω or ∞			

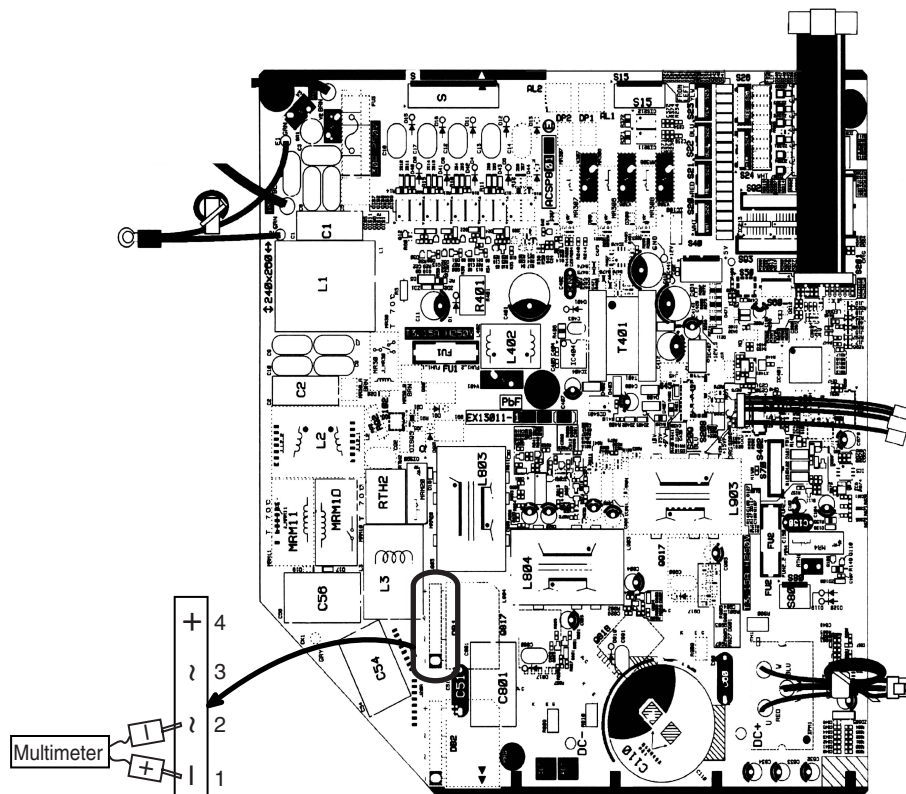

(R21937)

8.14 Capacitor Voltage Check

Check No.21

Before this check, be sure to check the main circuit for short circuit.

With the circuit breaker still on, measure the voltage according to the drawing of the model in question. Be careful never to touch any live parts.

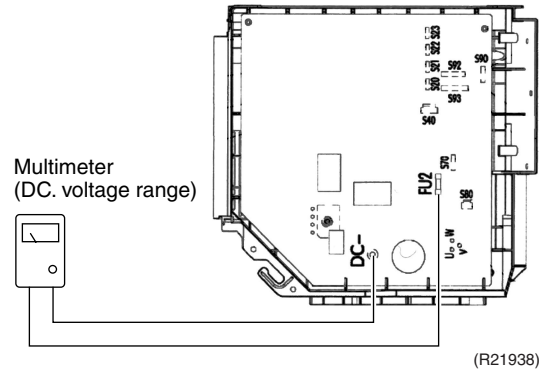

- To prevent an electrical shock, use a multimeter to check that the voltage between FU2 and DC- is 50 V or less.
- The surface of the test points (DC-) may be covered with the coating. Be sure to make firm contact between the multimeter probes and the test points.

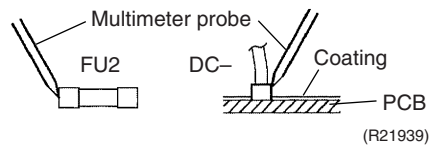

8.15 Power Module Check

Check No.22

Check to make sure that the voltage between (+) and (-) of the power module is about 0 V before checking.

- Disconnect the compressor harness connector from the outdoor unit PCB. To disengage the connector, press the protrusion on the connector.
- Follow the procedure below to measure resistance between the (+) or (-) terminal of the power module and the U, V, or W terminal of the compressor with a multimeter. Evaluate the measurement results referring to the following table.

Positive terminal (+) of digital multimeter	Power module (+)	UVW	Power module (-)	UVW
Negative terminal (-) of digital multimeter	UVW	Power module (+)	UVW	Power module (-)
Resistance is OK.	several kΩ ~ several MΩ			
Resistance is NG.	0 Ω or ∞			

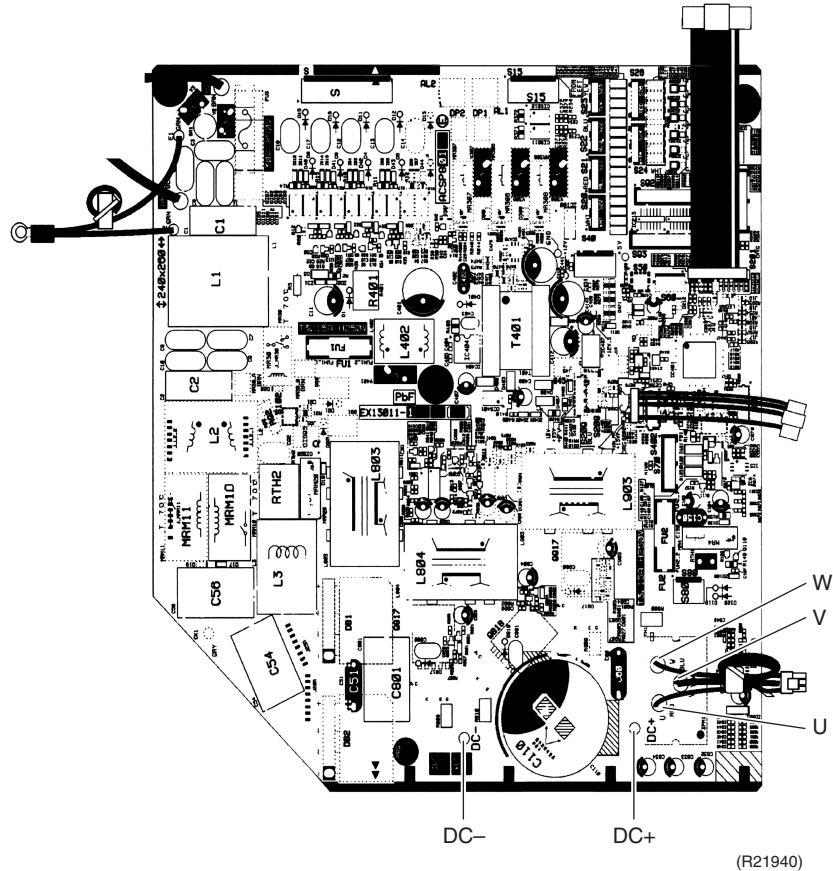

Part 7

Trial Operation and Field Settings

1. Pump Down Operation	178
2. Wiring Error Check Function	179
3. Trial Operation	181
3.1 CTXS, FTXS, CDXS, FDXS, FVXS Series	181
3.2 FFQ Series	183
4. Field Settings	185
4.1 Outdoor Unit	185
4.2 CTXS, FTXS, CDXS, FDXS, FVXS Series	187
4.3 FFQ Series	192
5. Silicon Grease on Power Transistor / Diode Bridge	199

1. Pump Down Operation

Pump Down Operation

In order to protect the environment, be sure to conduct pump down operation when relocating or disposing the unit.

1. Remove the valve caps from the liquid stop valve and the gas stop valve.
2. Carry out forced cooling operation.
3. After 5 ~ 10 minutes, close the liquid stop valve with a hexagonal wrench.
4. After 2 ~ 3 minutes, close the gas stop valve and stop the forced cooling operation.

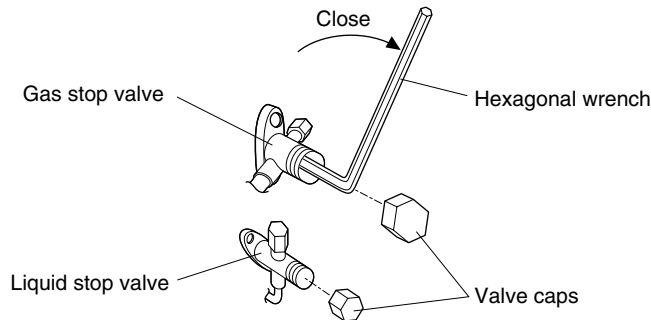

(R14566)

Forced cooling operation

Procedure	<ol style="list-style-type: none"> 1. Turn the power off. 2. Remove the switch cover. 3. Turn off all the switches of SW5 and SW6 on the service monitor PCB. 4. Set the operation mode switch (SW2) to COOL. 5. Screw the switch cover again. 6. Turn the power on. 7. Wait until the 3-minute standby mode finishes. 8. Press the forced cooling operation ON/OFF switch (SW1).
Command frequency	18 class: 52 Hz 24/36 class: 30 Hz
Ending conditions	<ol style="list-style-type: none"> 1. Press the forced cooling operation ON/OFF switch (SW1) again. 2. The operation ends automatically after 11 ~ 15 minutes (depending on the model).

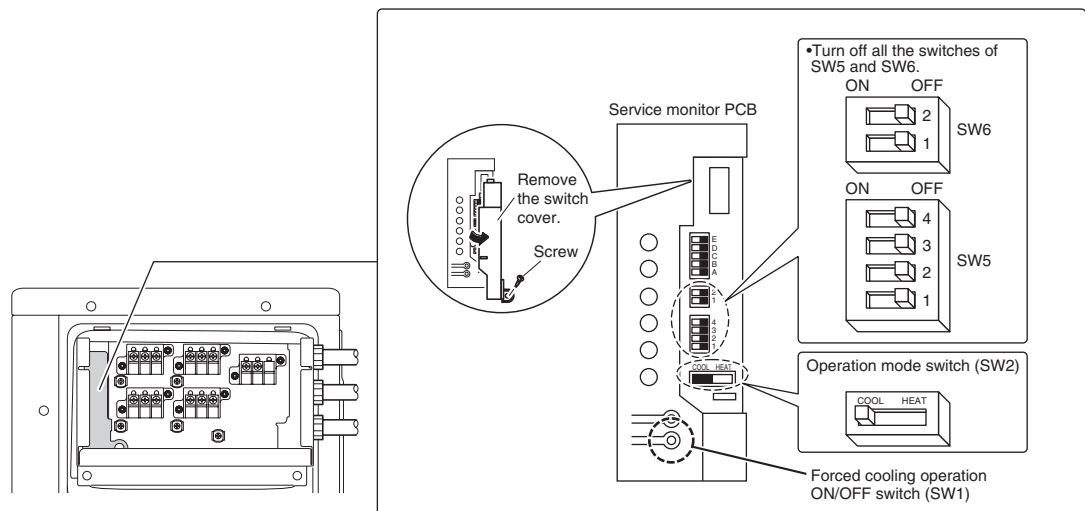

(R22273)

2. Wiring Error Check Function

Outline

Wiring error check function is designed for the microcomputer to correct wiring errors itself. If local wiring is unclear in the case of buried piping, for example, just press the wiring error check switch on the outdoor unit. Even if the connections for Room A and Room B are confused, the system may run without a hassle. Note that this check function does not work in the following cases.

- For 3-minute standby period after the power is turned on or after the compressor has stopped.
 - When the outdoor temperature is below 5°C (41°F).
 - If the indoor unit is in trouble (also in case of all-room transmission failure).
- When the piping and wiring are perfect, there is no need to use this function.

Procedure

1. Press the wiring error check switch (SW3) on the service monitor PCB of the outdoor unit, and the wiring error check function is activated.
2. In about 15 ~ 20 minutes, the check finishes automatically.
3. When the check is over, the service monitor LED indicators start blinking.

LED	1	2	3	4	5	Judgment
Status	Blinking one after another					Self-correction completed
	All blinking					Self-correction impossible
	Any of the LEDs stay on.					Emergency stop

- Self-correction completed...The LED indicators 1 ~ 2 (18 class), 1 ~ 3 (24 class), or 1 ~ 4 (36 class) blink one after another.
- Self-correction impossible...The LED indicators blink all at the same time.
 - * Transmission failure occurs at any of the indoor units.
 - * The indoor heat exchanger thermistor is disconnected.
 - * An indoor unit is in trouble (if a trouble occurs during the wiring error checking).
- Emergency stop...If any of the LED indicators stay on, follow the diagnostic procedure.

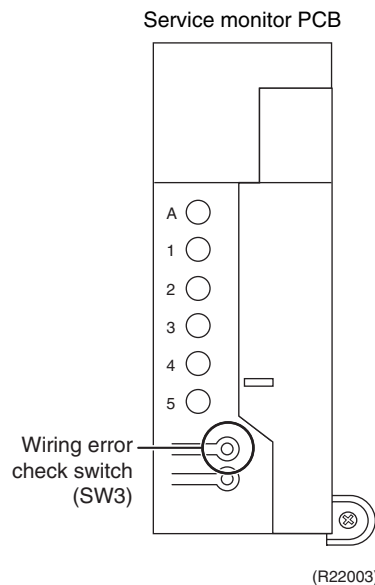

Details

- Refrigerant flows from Port A and on. The indoor heat exchanger temperatures are detected one by one to check up the matching between the piping and wiring.
- With this function on, freezing (crackling) noise may be heard from the indoor unit. This is not a problem. (This is because the indoor heat exchanger temperature is made to drop below 0°C (32°F) in order to increase the detection accuracy.)
- The indoor fan turns on or off during wiring checking.
- The results can be checked by looking at the service monitor LED indicators, when the wiring error checking is over. The LED indicators stop blinking when the ordinary operation starts.
 LED1...Room A wiring, LED2...Room B wiring
 1st blinking LED...Port A piping, 2nd blinking LED...Port B piping
 The 1st blinking LED means the room that is connected with Port A. The 2nd blinking LED means the one connected with Port B.

Ex: Suppose the LED indicators are blinking as follows.

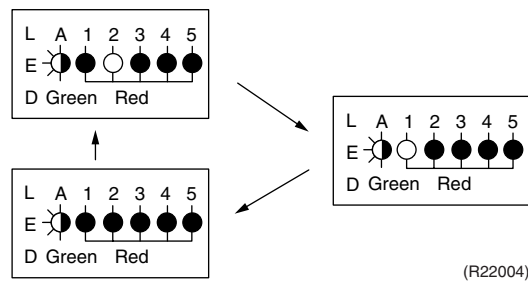

The above means that Port A is connected with Room B, and Port B with Room A (or self-corrected this way.)

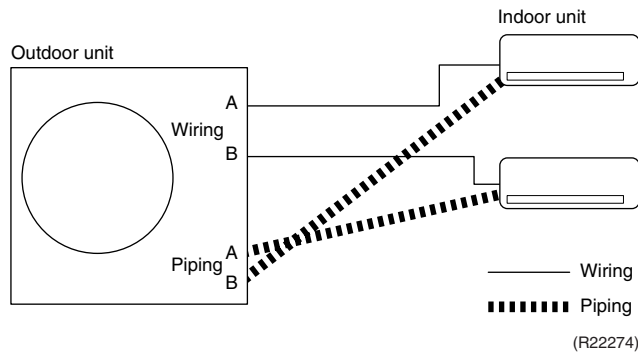

Note:

1. Wrongly connected liquid and gas pipes cannot be self-corrected. Be sure to make the liquid pipe and the gas pipe in pairs.
2. To cancel the wiring error check procedure halfway, press the wiring error check switch again. In this case, the memory of the microcomputer returns to its initial status (Room A wiring → Port A piping, Room B wiring → Port B piping).
3. When replacing the outdoor unit PCB, be sure to use this function.
4. Make the priority room setting after wiring error check. If you set the priority room before wiring error check, the prioritized room may be changed after self-correction.

3. Trial Operation

3.1 CTXS, FTXS, CDXS, FDXS, FVXS Series

Outline

Carry out the trial operation in accordance with the operation manual to ensure that all functions and parts, such as flap movement, are working properly.

Trial operation should be carried out in either cooling or heating operation.

Detail

1. Measure the power supply voltage and make sure that it falls within the specified range.
2. In cooling operation, select the lowest programmable temperature (18°C (64°F)); in heating operation, select the highest programmable temperature (30°C (86°F)).
 - ♦ Trial operation may be disabled in either operation mode depending on the room temperature.
 - ♦ After trial operation is complete, set the temperature to a normal level (26 ~ 28°C (78 ~ 82°F) in cooling, 20 ~ 24°C (68 ~ 75°F) in heating).
 - ♦ For protection, the system does not start for 3 minutes after it is turned off.

ARC452 Series

- (1) Press the **ON/OFF** button to turn on the system.
- (2) Press both of the **TEMP** buttons and the **MODE** button at the same time.
- (3) Press the **MODE** button twice.
(? appears on the display to indicate that trial operation is selected.)
- (4) Press the **MODE** button and select the operation mode.
- (5) Trial operation terminates in approximately 30 minutes and switches into normal mode. To quit trial operation, press the **ON/OFF** button.

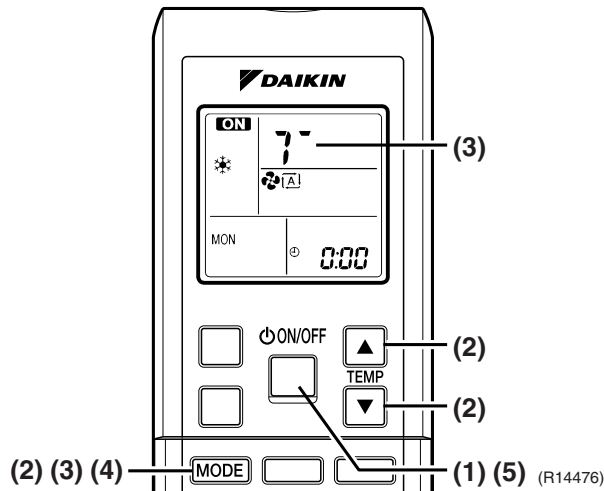

ARC466 Series

- (1) Press the **On/Off** button to turn on the system.
- (2) Press the center of the **Temp** button and the **Mode** button at the same time.
- (3) Select 7⁺ (trial operation) with the **Temp ▲** or **Temp ▼** button.
- (4) Press the **Mode** button to start the trial operation.
- (5) Press the **Mode** button and select operation mode.
- (6) Trial operation terminates in approx. 30 minutes and switches into normal mode. To quit trial operation, press the **On/Off** button.

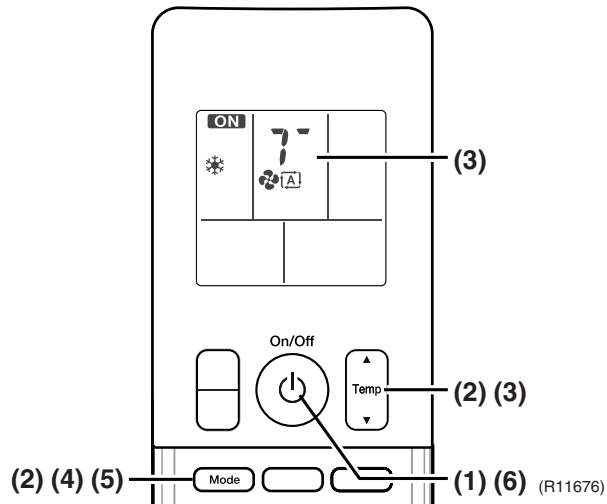

3.2 FFQ Series

3.2.1 Checkpoints

To carry out test operation, check the following:

- Check that the temperature setting of the remote controller is at the lowest level in cooling operation or use test operation mode.
- Go through the following checklist:

Checkpoints	Cautions or warnings
Are all units securely installed?	<ul style="list-style-type: none"> ● Dangerous for turning over during storm ● Possible damage to pipe connections
Is the ground wire installed according to the applicable local standard?	Dangerous if electric leakage occurs.
Are all air inlets and outlets of the indoor and outdoor units unobstructed?	<ul style="list-style-type: none"> ● Poor cooling ● Poor heating
Does the drain flow out smoothly?	Water leakage
Is piping adequately heat-insulated?	Water leakage
Have the connections been checked for refrigerant leakage?	<ul style="list-style-type: none"> ● Poor cooling ● Poor heating ● Stop
Is the power supply voltage conform to the specifications on the name plate?	Incorrect operation
Are the cable sizes as specified and according to local regulations?	Damage of cables
Are the remote controller signals received by the unit?	No operation

3.2.2 Test operation

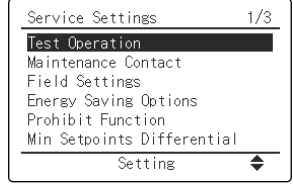
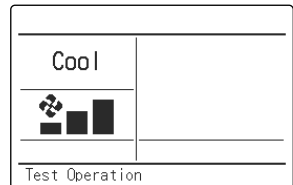

BRC1E71/72/73

Note: The illustrations are for BRC1E72 as representative.

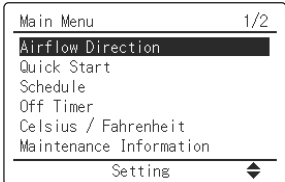
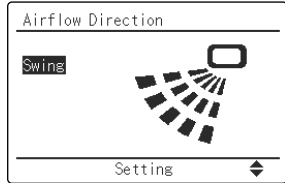
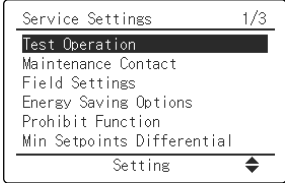
Step	Action	Remote controller
Before test operation		
1	Turn on the power supply more than 6 hours before test operation.	
2	Open the gas stop valve.	
3	Open the liquid stop valve.	
How to activate test operation		
4	Press and hold the Cancel button for 4 seconds to enter the Service Settings menu.	
5	Use the ▼▲ buttons to select Test Operation and push the Menu/OK button.	 <p style="text-align: right;">(R18827)</p>
6	Test Operation is displayed on the bottom of the basic screen.	 <p style="text-align: right;">(R18828)</p>
7	Push the On/Off button within 10 seconds to start the test operation.	

Step	Action	Remote controller
How to check airflow direction		
8	Push the Menu/OK button to enter the Main Menu .	
9	Use the ▼▲ buttons to select Airflow Direction and push the Menu/OK button.	 <p>(R18829)</p>
10	Check that the airflow direction is actuated according to the setting and push the Menu/OK button.	 <p>(R18830)</p>
How to deactivate test operation		
11	Press and hold the Cancel button for 4 seconds to enter the Service Settings menu.	
12	Use the ▼▲ buttons to select Test Operation in the menu and push the Menu/OK button.	 <p>(R18827)</p>

BRC7E830

Step	Action
1	Turn on the power supply more than 6 hours before test operation.
2	Open the gas stop valve.
3	Open the liquid stop valve.
4	Set to cooling operation with the remote controller and start operation by pressing ON/OFF button.
5	Press the INSPECTION/TEST button ( /TEST) 2 times and operate at test operation mode for 3 minutes.
6	Press the SWING button to make sure the unit is in operation.
7	Press the INSPECTION/TEST button ( /TEST) and operate normally.
8	Confirm all the function of unit according to the operation manual.
9	If the decoration panel has not been installed, turn off the power after the test operation.

4. Field Settings

4.1 Outdoor Unit

4.1.1 Priority Room Setting

Outline

1. Operation mode
The operation mode of the prioritized room takes precedence. For example, when the prioritized indoor unit starts cooling operation, the other indoor units which have been in heating operation enter the standby mode. Heating operation will resume if the prioritized indoor unit stops cooling operation.
2. POWERFUL operation
The electronic expansion valves are controlled to provide more capacity to the prioritized room and the capacities for the other indoor units will be slightly reduced.
3. OUTDOOR UNIT QUIET operation
When the OUTDOOR UNIT QUIET operation is selected in the prioritized room, the outdoor unit runs quietly.
(Without priority room setting, OUTDOOR UNIT QUIET operation starts only when the function is set for all the operating indoor units.)

Procedure

1. Turn the circuit breaker off before changing the setting.
2. Turn on the one of the switches of the SW4 on the service monitor PCB.
Only one room can be set as the priority room.
3. Turn the power on.

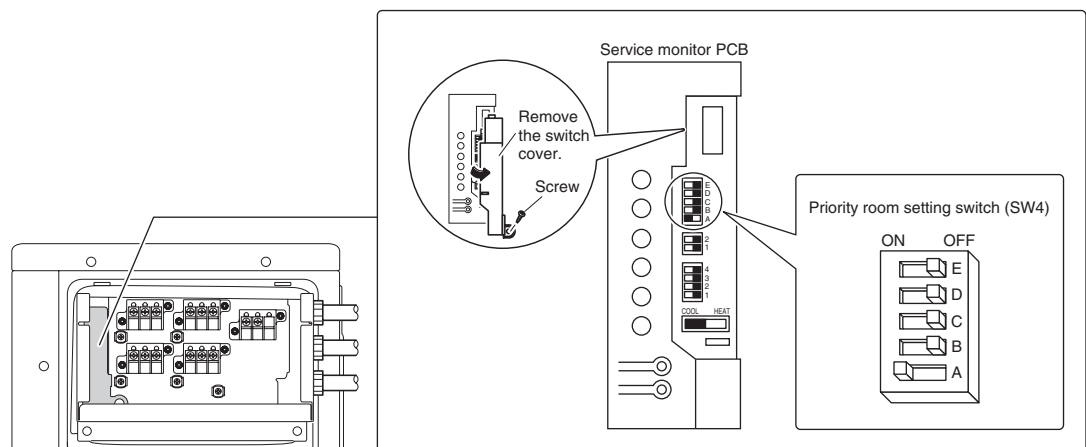

(R22006)

4.1.2 COOL / HEAT Mode Lock

Use the S15 connector to set the unit to cooling only or heating only.
 Setting to heating only (H): Short-circuit the pins 1 and 3 of the connector S15.
 Setting to cooling only (C): Short-circuit the pins 3 and 5 of the connector S15.
 The following specifications apply to the connector housing and pins.

- JST products:
 Housing: VHR-5N
 Pin: SVH-21T-1, 1

Note that forced operation is also possible in cooling / heating mode.

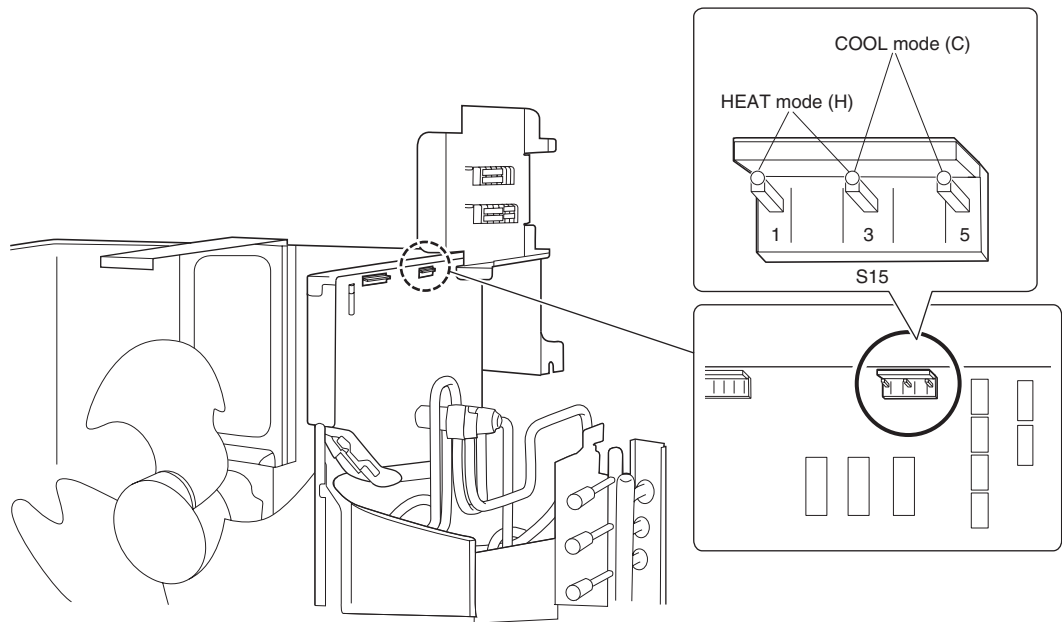

(R22007)

4.1.3 NIGHT QUIET Mode

Outline

If NIGHT QUIET mode is to be used, initial settings must be made when the unit is installed. Explain the function of NIGHT QUIET mode, as described below, to the customer, and confirm whether or not the customer wants to use NIGHT QUIET mode. NIGHT QUIET mode function reduces operating noise of the outdoor unit at nighttime. This function is useful if the customer is worried about the effects of the operating noise on the neighbors. However, if NIGHT QUIET mode is running, cooling capacity is reduced.

Procedure

Turn on the SW6-1 on the service monitor PCB of the outdoor unit.

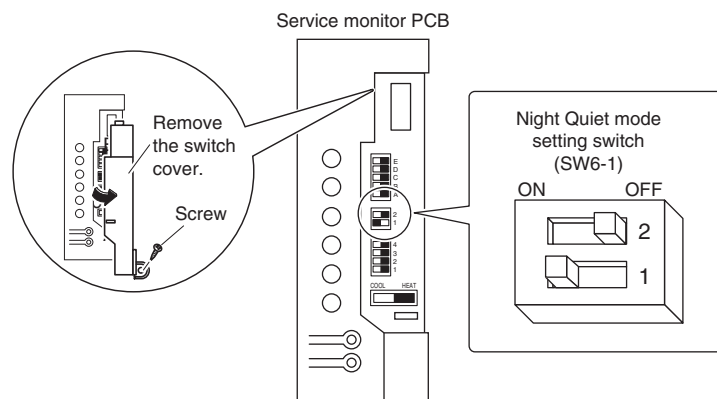

(R22008)

4.2 CTXS, FTXS, CDXS, FDXS, FVXS Series

4.2.1 Model Type Setting

ARC452A21, ARC452A23

- The remote controller is common to the heat pump model and cooling only model.
- Make sure the DIP switch is set to the left side. The heating operation will not be available when the DIP switch is set to the right side.

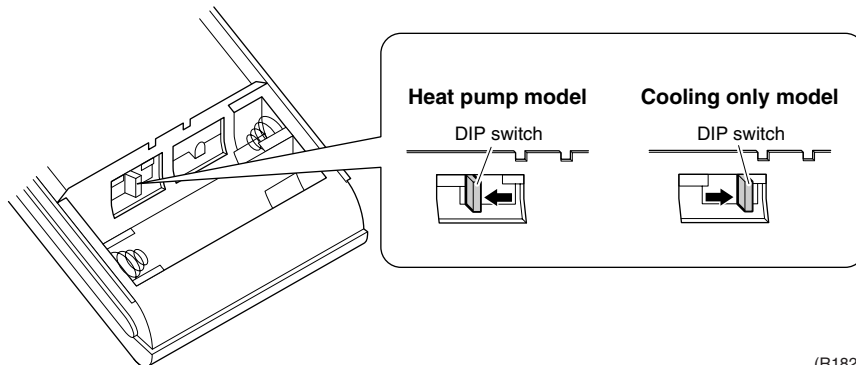

(R18201)

ARC466A21

- The remote controller is common to the heat pump model and cooling only model.

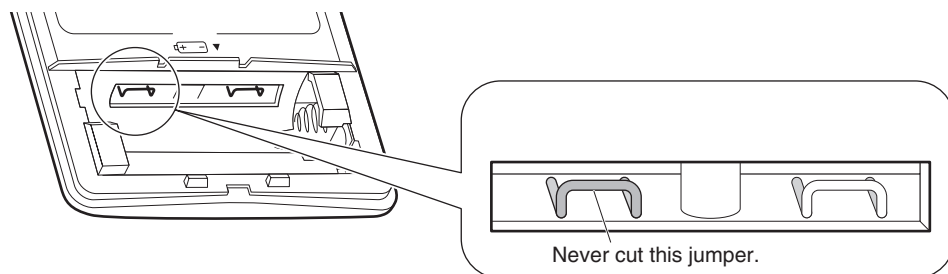

(R18451)



Caution

Replace the remote controller if you cut the jumper on the left side.

The heating operation will not be available when the jumper on the left side is cut.

4.2.2 Temperature Display Switch

You can select Fahrenheit or Celsius for temperature display.

ARC452A21, ARC452A23

- Press the **TEMP▲** and **TEMP▼** buttons at the same time for 5 seconds to change the unit of temperature display.

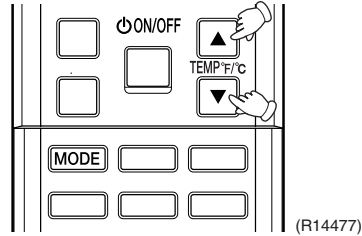

ARC466A21

- Press the upper side of the **Temp** button and the **On** button at the same time for 5 seconds to change the unit of temperature display.

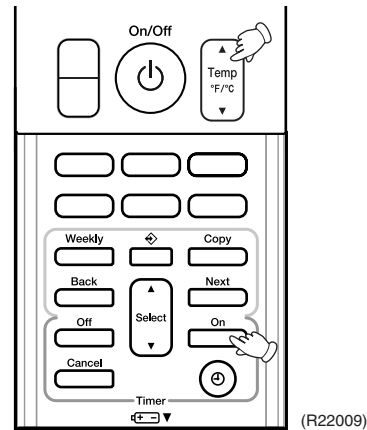

4.2.3 When 2 Units are Installed in 1 Room

Outline

When 2 indoor units are installed in 1 room, 1 of the 2 indoor units and the corresponding wireless remote controller can be set for different address.

Both the indoor unit PCB and the wireless remote controller need alteration.

The method of address setting varies depending on the type of indoor unit and the series of wired remote controller. Refer to the following pages for the appropriate indoor unit and wireless remote controller.

CTXS, FTXS Series

- (1) Remove the front grille.
- (2) Remove the electrical box.
- (3) Remove the shield plate of the electrical box.
- (4) Cut the address setting jumper JA on the PCB.

CTXS07LVJU, FTXS09/12LVJU

FTXS15/18LVJU

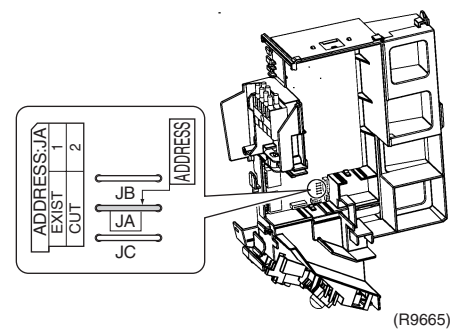
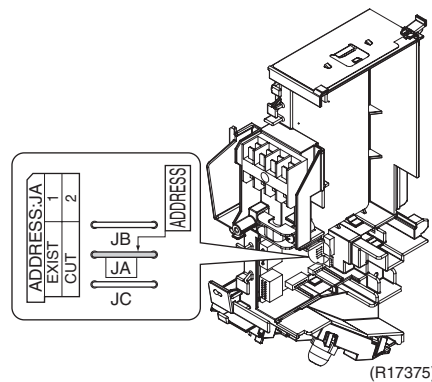

Caution

Replace the PCB if you accidentally cut a wrong jumper.

Jumpers are necessary for electronic circuit. Improper operation may occur if you cut any of them.

CDXS, FDXS Series

- Cut the jumper JA on PCB.

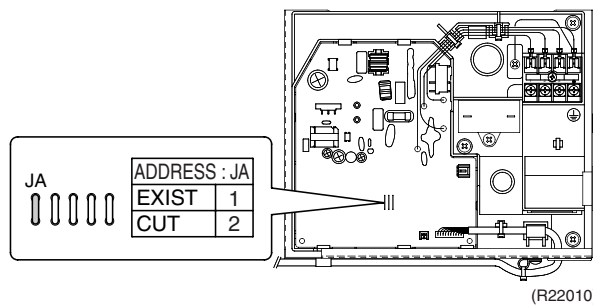

Caution

Replace the PCB if you accidentally cut a wrong jumper.

Jumpers are necessary for electronic circuit. Improper operation may occur if you cut any of them.

FVXS Series

- (1) Remove the front grille.
- (2) Lift the sensor PCB fixing plate and remove the front shield plate.
- (3) Disconnect the connectors S1, S41, S42.
- (4) Remove the electric box (1 screw).
- (5) Pull out the indoor heat exchanger thermistor.
- (6) Remove the shield plate (8 tabs).
- (7) Cut the address setting jumper JA on the indoor unit PCB.

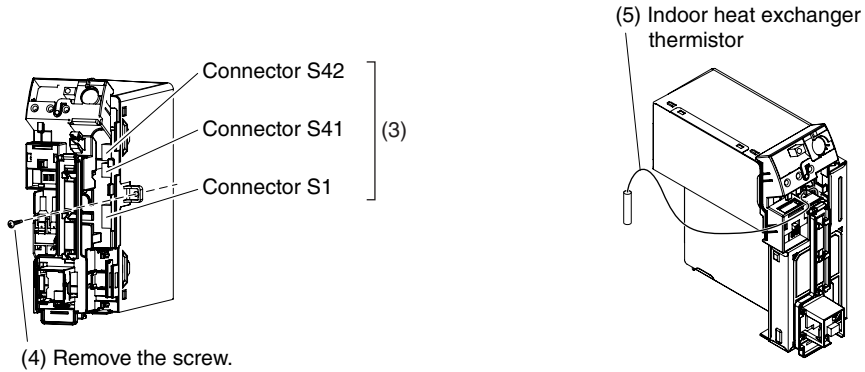

(4) Remove the screw.

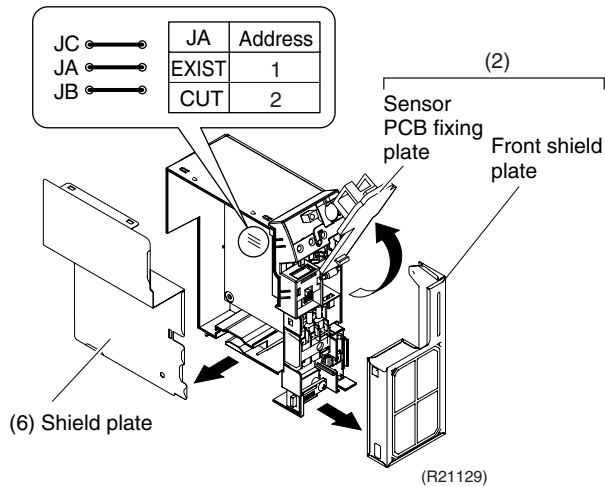

Caution

Replace the PCB if you accidentally cut a wrong jumper.

Jumpers are necessary for electronic circuit. Improper operation may occur if you cut any of them.

Wireless Remote Controller

- (1) Remove the cover and take it off.
- (2) Cut the address setting jumper.

ARC452 series

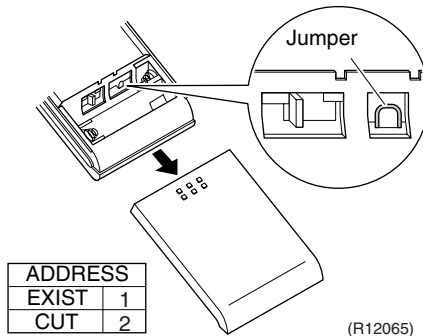

(R12065)

ARC466 series

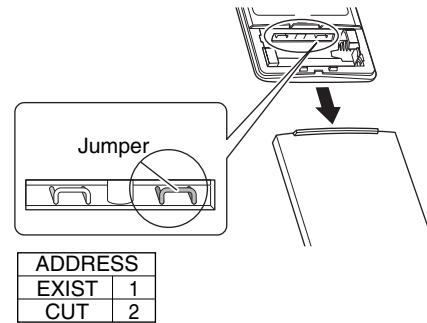

* Do not cut the left jumper.

(R18416)



Caution

Replace the remote controller if you accidentally cut a wrong jumper.

Jumpers are necessary for electronic circuit. Improper operation may occur if you cut any of them.

4.2.4 Jumper Settings

Jumper (on indoor unit PCB)	Function	When connected (factory set)	When cut
JB	Fan speed setting when compressor stops for thermostat OFF. (effective only at cooling operation)	Fan speed setting; Remote controller setting	The fan stops.
JC	Power failure recovery function	Auto-restart	The unit does not resume operation after recovering from a power failure. Timer settings are cleared.

FVXS series

Switch (on indoor unit PCB)	Function	OFF (factory setting)	ON
SW2-4	Upward airflow limit setting	Exposed or half embedded installation	Set the switch to ON position when you install the indoor unit embedded in the wall to avoid condensation.



For the location of the jumper, refer to the following pages.

CTXS07LVJU, FTXS09/12LVJU: page 18

FTXS15/18/24LVJU: page 20

FDXS09/12LVJU, CDXS15/18/24LVJU: page 22

FVXS09/12/18NVJU: page 24

4.3 FFQ Series

4.3.1 How to Change the Field Settings

Outline

If optional accessories are mounted on the indoor unit, the indoor unit setting may have to be changed. Refer to the instruction manual for each optional accessory.

BRC1E71/72/73

Note: The illustrations are for BRC1E72 as representative.

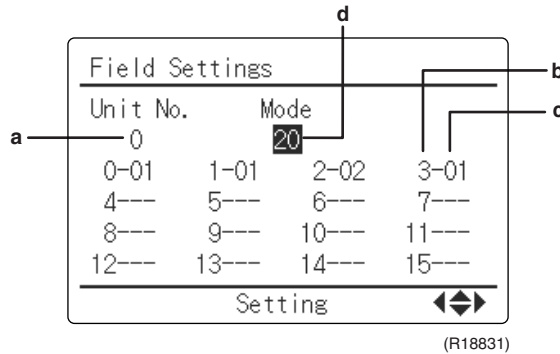

- a Unit No.
- b First code No.
- c Second code No.
- d Mode

Step	Action	Remote controller
1	Press and hold the Cancel button for 4 seconds to enter the Service Settings menu.	
2	Use the ▼▲ buttons to select Field Settings and push the Menu/OK button.	<p>(R18832)</p>
3	Use the ▼▲ buttons to select the desired Mode.	<p>(R18831)</p>
4	During group control, when setting by each indoor unit (Mode 20, 21, 22 or 23 have been selected), push the ◀ button to highlight and ▼▲ buttons to select the Unit No. to be set. This operation is unnecessary when setting by group.	
5	Highlight the second code No. to be changed using the ◀▶ buttons, and use the ▼▲ buttons to select the desired second code No.	<p>(R18833)</p> <p>When setting by group, all of the second code No. that may be set are displayed as *.</p>

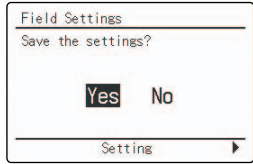
Step	Action	Remote controller
6	Push the Menu/OK button to display the confirmation screen.	
7	Use the ◀▶ buttons to select Yes and push the Menu/OK button.	 <p>(R18834)</p> <p>When multiple setting changes are needed, repeat steps 3 to 7.</p>
8	Push the Cancel button 2 times to return to basic screen.	

BRC7E830

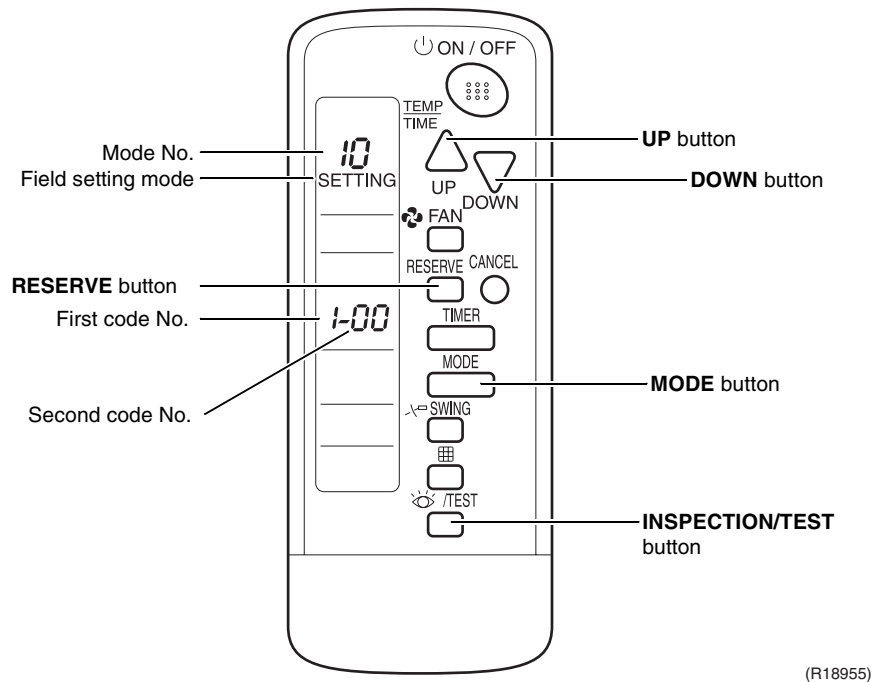

To set the field settings, you have to change:

- Mode No.
- First code No.
- Second code No.

Step	Action
1	Press the INSPECTION/TEST button for 4 seconds during normal mode to enter the field setting mode.
2	Press the MODE button to select the desired mode No.
3	Press the UP button to select the first code No.
4	Press the DOWN button to select the second code No.
5	Press the RESERVE button to confirm the setting.
6	Press the INSPECTION/TEST button to return to the normal mode.

4.3.2 Overview of the Field Settings

Mode No.	First Code No.	Description of setting		Second Code No.					
				01	02	03	04		
10 (20)	0	Filter cleaning sign interval	Ultra longlife filter	Light	Approx. 10,000 hrs.	Heavy	Approx. 5,000 hrs.	—	—
			Longlife filter		Approx. 2,500 hrs.		Approx. 1,250 hrs.		
	1	Longlife filter type		Longlife filter	Ultra longlife filter	—	—		
	2	Remote controller thermistor		Enabled	Disabled	—	—		
	3	Filter cleaning sign		Display	No display	—	—		
11 (21)	0	Indoor unit number of simultaneous operation system		Pair	Twin	Triple	Double twin		
	1	Simultaneous operation system individual setting		Unified setting	Individual setting	—	—		
	2	Fan OFF at thermostat OFF		Standard	Fan OFF	—	—		
	7	External static pressure setting		Airflow adjustment is OFF	Completion of airflow adjustment	Start of airflow adjustment	—		
12 (22)	0	Optional accessories output selection (field selection of output for adaptor for wiring)		Compressor	—	Operation output	Error output		
	1	Forced ON/OFF function		Forced OFF	ON/OFF operation	—	—		
	2	Thermostat differential changeover (setting for when using remote sensor)		1°C	0.5°C	—	—		
13 (23)	0	High air outlet velocity (for high ceiling applications)		≤ 2.7 m	2.7 ~ 3.0 m	3.0 ~ 3.5 m	—		
	1	Selection of airflow direction (setting for when a blocking pad kit has been installed)		4-way flow	3-way flow	2-way flow	—		
	3	Selection of airflow function (setting for when using a decoration panel for outlet)		Equipped	Not equipped	—	—		
	4	Airflow direction range setting		Upper	Normal	Lower	—		
	6	External static pressure		Standard	High	Low	—		
15 (25)	3	Drain pump operation with humidifying		Not equipped	Equipped	—	—		

■ : factory setting



Note: Any function that is not available on the indoor unit is not displayed.

4.3.3 MAIN / SUB Setting when Using 2 Wired Remote Controllers

Outline

The MAIN / SUB setting is necessary when 1 indoor unit is controlled by 2 remote controllers. When you use 2 remote controllers (control panel and separate remote controller), set one to MAIN and the other to SUB.

Detail

The remote controllers are factory set to MAIN, so you only have to change one remote controller from MAIN to SUB.

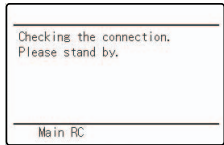
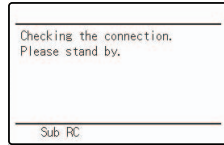
Step	Action	Remote controller
1	Put on the power for both remote controllers.	
2	Determine which one is the sub/main remote controller.	
3	When Checking the connection. Please stand by. is displayed on both remote controllers, push and hold the Mode button of the sub remote controller for 4 seconds.	 <p style="text-align: right;">(R18973)</p>
4	The sub remote controller now displays Sub RC. Note) The main remote controller still displays Main RC.	 <p style="text-align: right;">(R18974)</p>
5	After a few seconds, the basic screen is displayed.	

4.3.4 Address and MAIN / SUB Setting for Wireless Remote Controller

Outline

If several wireless remote controller units are used together in the same room (including the case where both group control and individual remote controller control are used together), be sure to set the addresses for the receiver and wireless remote controller. (For group control, see the attached installation manual for the indoor unit.) If using together with a wired remote controller, you have to change the MAIN / SUB setting on the signal receiver PCB.

Signal Receiver PCB

Set the address setting switch (SS2) on the signal receiver PCB according to the table below.

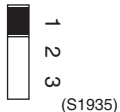
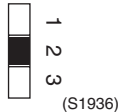
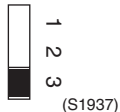
Unit No.	No.1	No.2	No.3
Address setting switch (SS2)	 (S1935)	 (S1936)	 (S1937)

When using both a wired and a wireless remote controller for 1 indoor unit, the wired controller should be set to MAIN. Therefore, set the MAIN / SUB setting switch (SS1) on the signal receiver PCB to SUB.

	MAIN	SUB
MAIN / SUB setting switch (SS1)	 (S1938)	 (S1939)

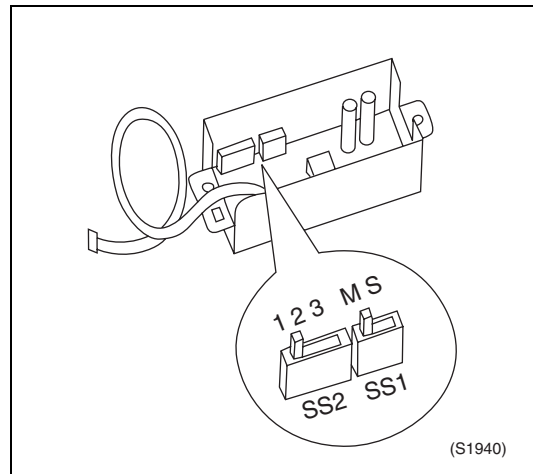

After completing setting, seal off the opening of the address setting switch (SS2) and the MAIN / SUB setting switch (SS1) with the attached sealing pad.

Wireless Remote Controller (Factory Set is 1)

1. Hold down the **FILTER SIGN RESET** (⌘) button and the **INSPECTION/TEST** button at the same time for at least 4 seconds to enter the field setting mode. (SETTING is indicated on the display).
2. Press the **FAN** button and select A or b. Each time the button is pressed, the display switches between A and b.
3. Press the **UP** button and the **DOWN** button to set the address.

→1→2→3→4→5→6

Address can be set from 1 ~ 6, but set it to 1 ~ 3 and to same address as the receiver. (The receiver does not work with address 4 ~ 6.)

4. Press the **RESERVE** button to confirm the setting.
5. Hold down the **INSPECTION/TEST** button for at least 1 second to exit the field setting mode and return to the normal display.

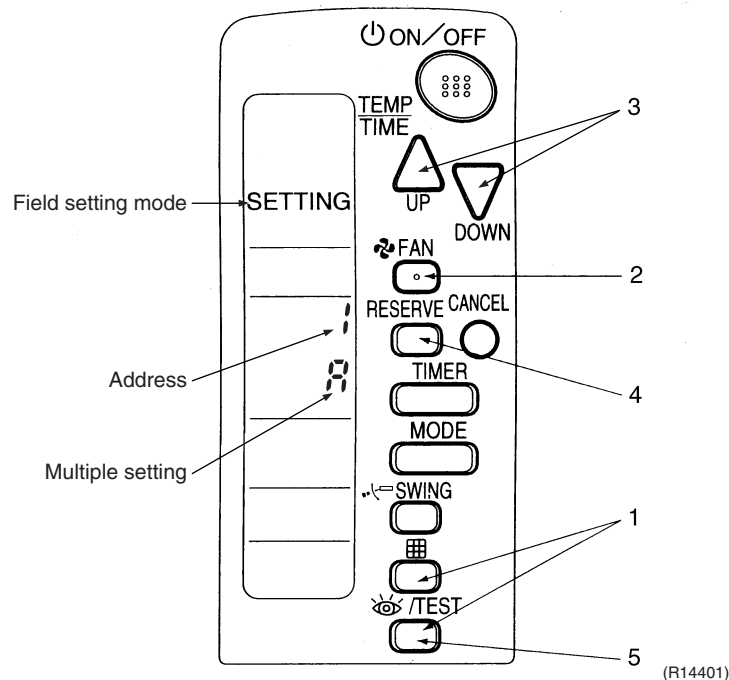

(R14401)

Multiple Settings A or b

When the indoor unit is controlled by an outside controller (central remote controller, etc.), it sometimes does not respond to ON/OFF command or temperature setting command from the remote controller. Check what setting the customer needs and make the multiple setting as shown below.

Remote Controller		Indoor Unit	
Multiple Setting	Remote Controller Display	Controlled by other air conditioners or devices	Other condition
A: Standard	All items are displayed.	ON/OFF command and temperature setting command cannot be accepted. (1 long beep or 3 short beeps emitted)	
b: Multiple display	Operations set only is displayed shortly after execution.	All the commands can be accepted (2 short beeps)	

After Setting

Stick the unit No. label at the decoration panel air discharge outlet as well as on the back of the wireless remote controller.

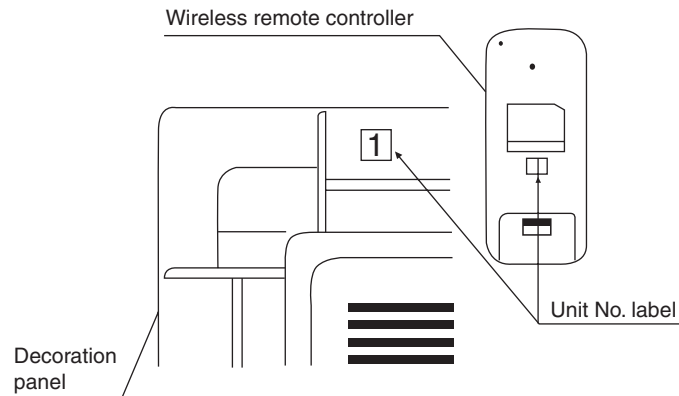

(R12961)



Note: Set the unit No. of the receiver and the wireless remote controller to be the same. If the settings differ, the signal from the remote controller cannot be received.

5. Silicon Grease on Power Transistor / Diode Bridge

Outline

Apply the specified silicon grease to the heat radiation part of a power transistor / diode bridge when you replace an outdoor unit PCB. The silicon grease encourages the heat radiation of a power transistor / diode bridge.

Detail

1. Wipe off the old silicon grease completely.
2. Apply the silicon grease evenly. See the illustrations below for examples of application.
3. Tighten the screws of the power transistor / diode bridge.
4. Make sure that the heat radiation parts are firmly contacted to the radiation fin.

Note: Smoke emission may be caused by bad heat radiation when the silicon grease is not appropriately applied.

- OK: Evenly applied

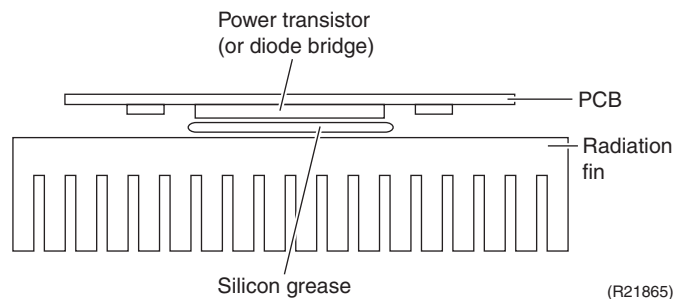

- NG: Not evenly applied

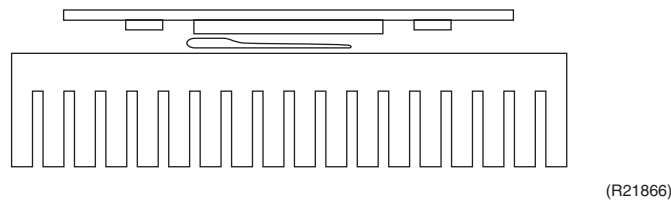

- NG: Foreign matter is stuck.

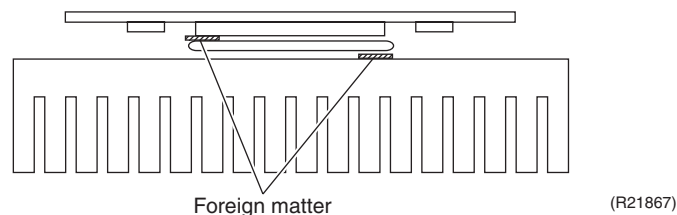

Part 8

Appendix

1. Piping Diagrams.....	201
1.1 Indoor Unit.....	201
1.2 Outdoor Unit.....	204
2. Wiring Diagrams.....	206
2.1 Indoor Unit.....	206
2.2 Outdoor Unit.....	211

1. Piping Diagrams

1.1 Indoor Unit

CTXS07LVJU, FTXS09/12LVJU

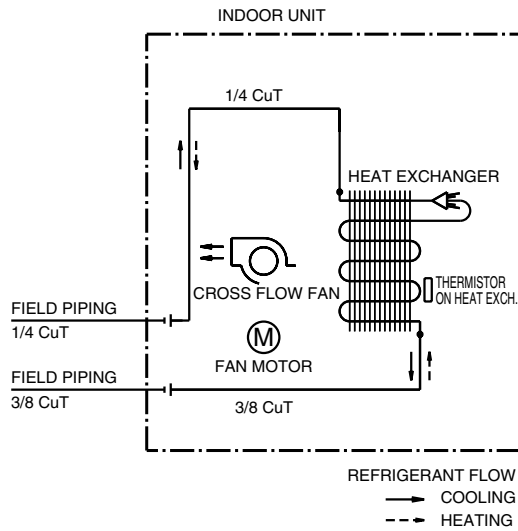

4D074606

FTXS15/18LVJU

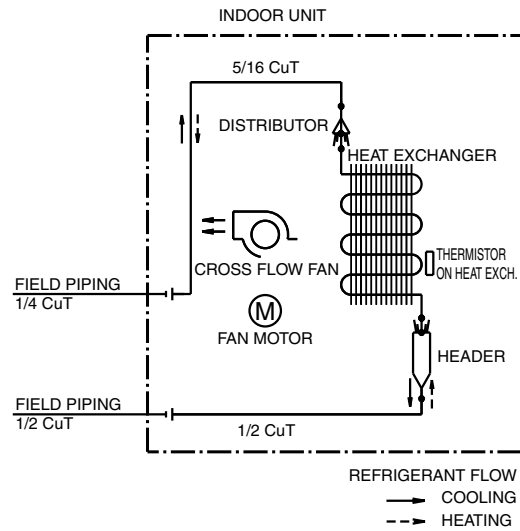

4D074609

FTXS24LVJU

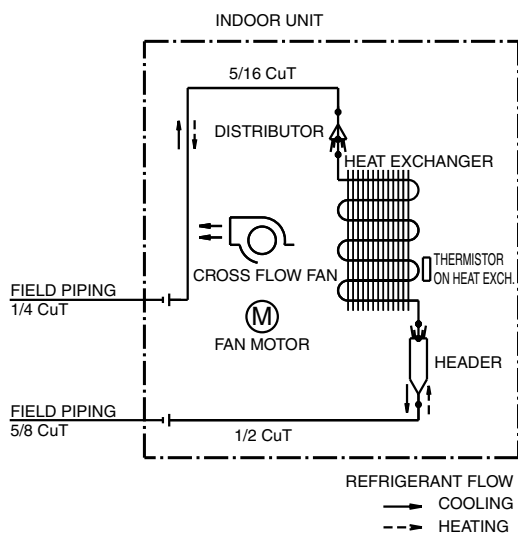

4D074608

FDXS09/12LVJU

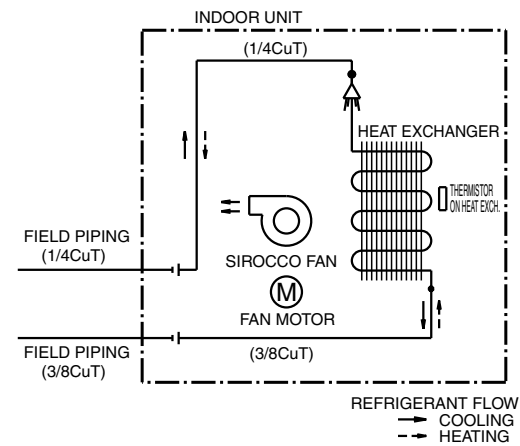

4D074621

CDXS15/18LVJU

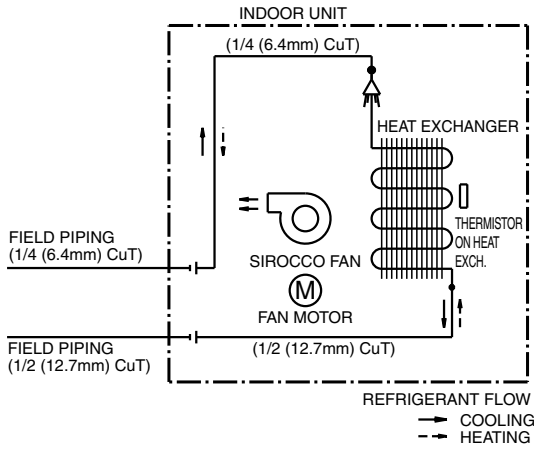

4D075271

CDXS24LVJU

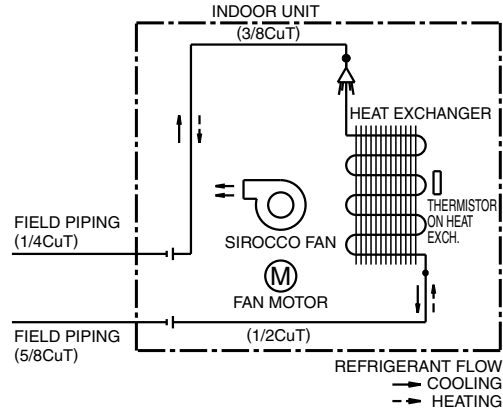

4D080593

FVXS09/12NVJU

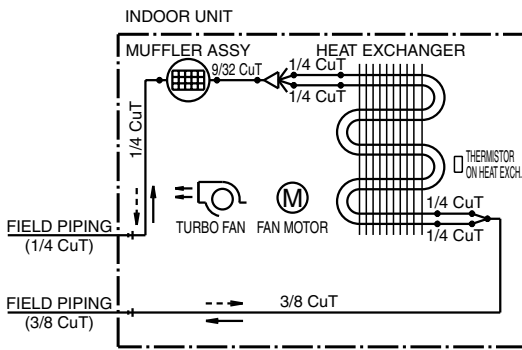

4D091794

FVXS18NVJU

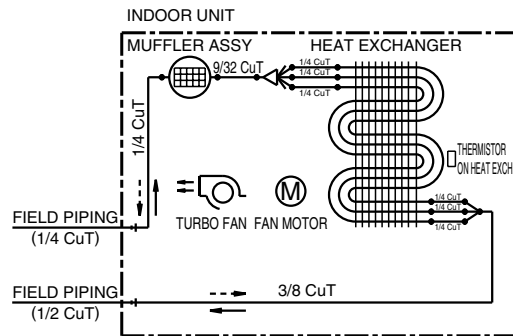

4D091795

FFQ09/12/15/18LVJU

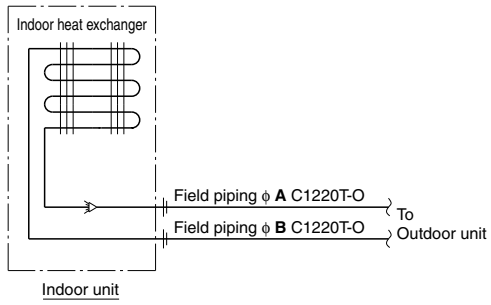

MODEL	A	B
FFQ09 · 12LVJU	1/4 (6.4)	3/8 (9.5)
FFQ15 · 18LVJU	1/4 (6.4)	1/2 (12.7)

4D080624

1.2 Outdoor Unit

2MXS18NMVJU

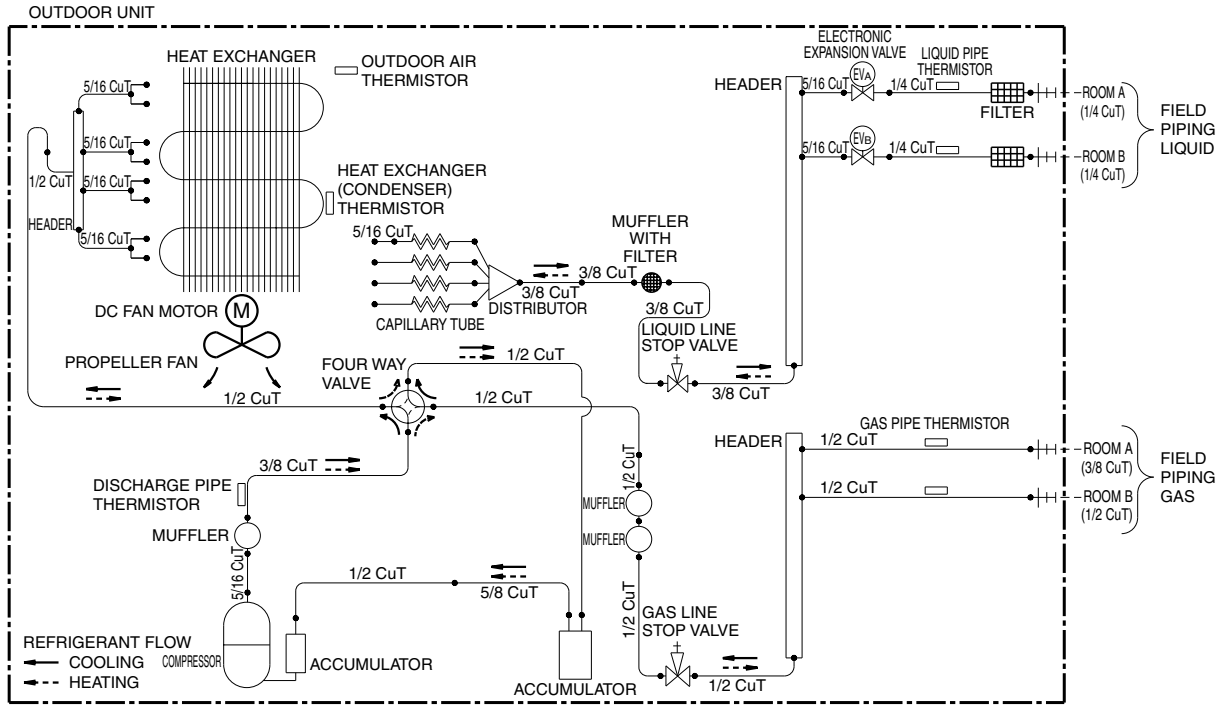

3D093190

3MXS24NMVJU

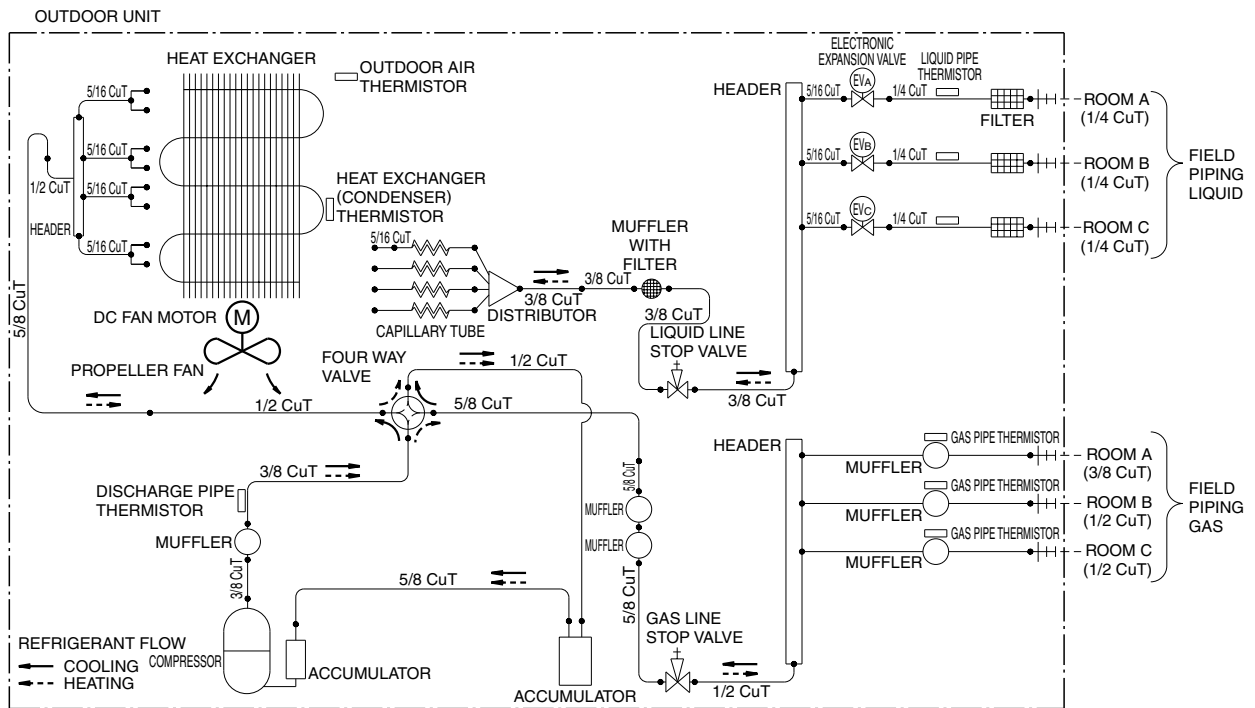

3D093191

4MXS36NMVJU

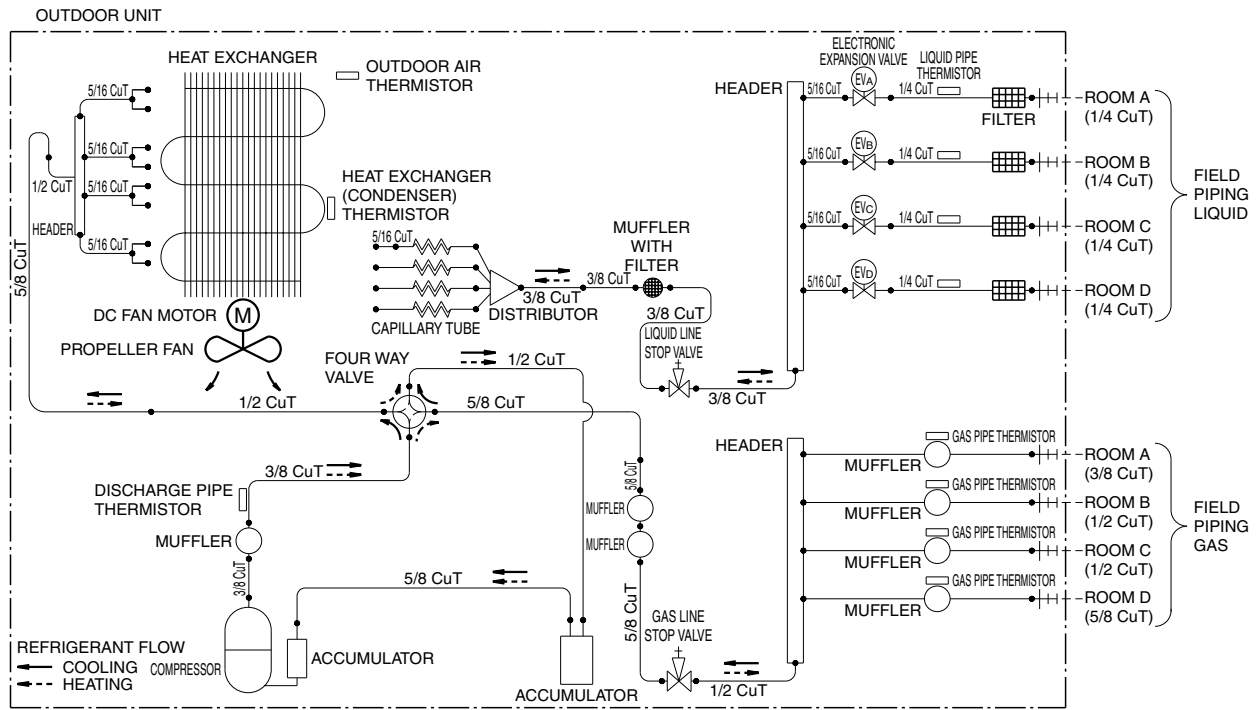

3D093192

2. Wiring Diagrams

2.1 Indoor Unit

CTXS07LVJU, FTXS09/12LVJU

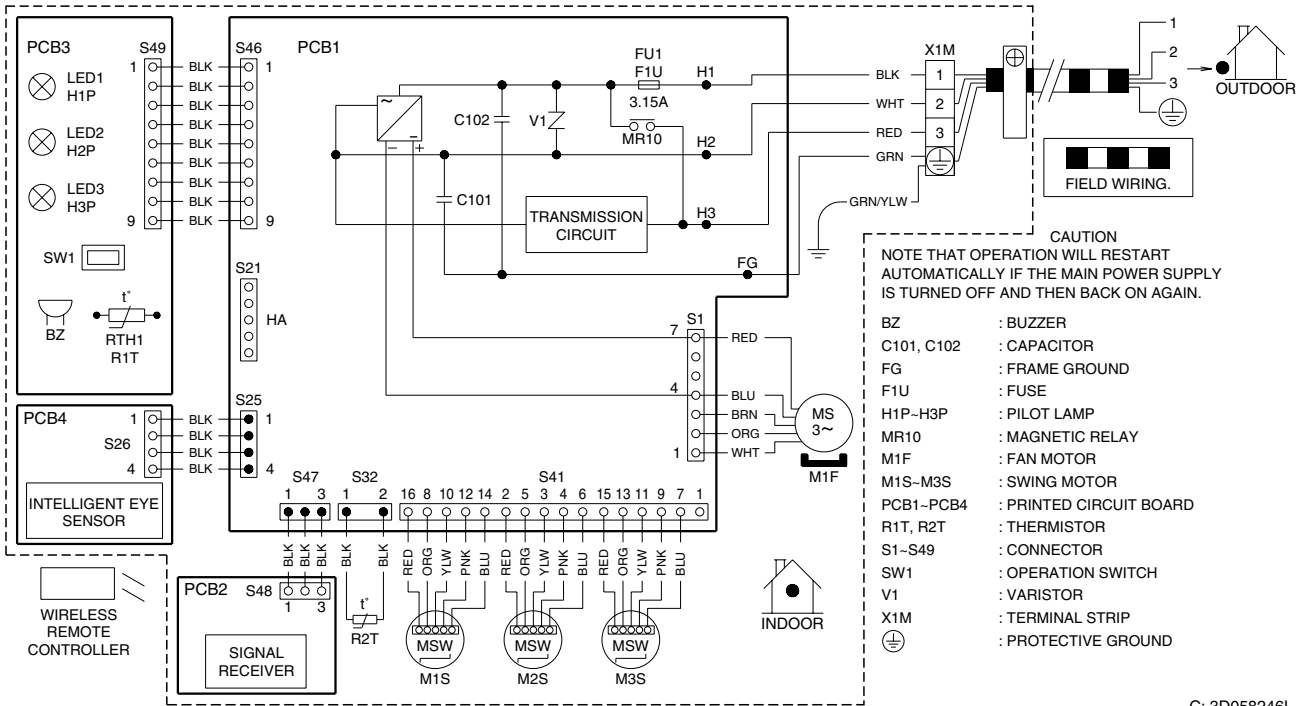

C: 3D058246L



Note: PCB1: Control PCB
 PCB2: Signal receiver PCB
 PCB3: Display PCB
 PCB4: INTELLIGENT EYE sensor PCB
 Refer to Part 3 for Printed Circuit Board Connector Wiring Diagram.

FTXS15/18/24LVJU

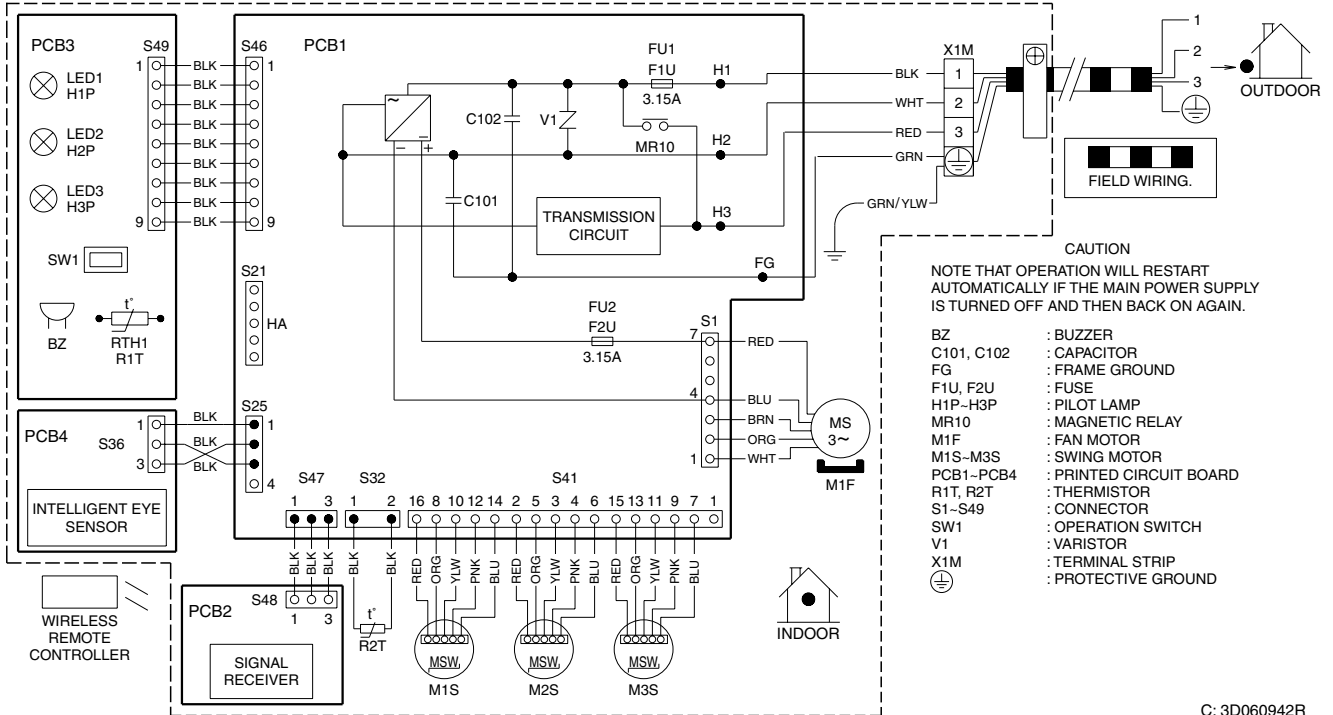

i Note: PCB1: Control PCB
 PCB2: Signal receiver PCB
 PCB3: Display PCB
 PCB4: INTELLIGENT EYE sensor PCB
 Refer to Part 3 for Printed Circuit Board Connector Wiring Diagram.

FDXS09/12LVJU, CDXS15/18/24LVJU

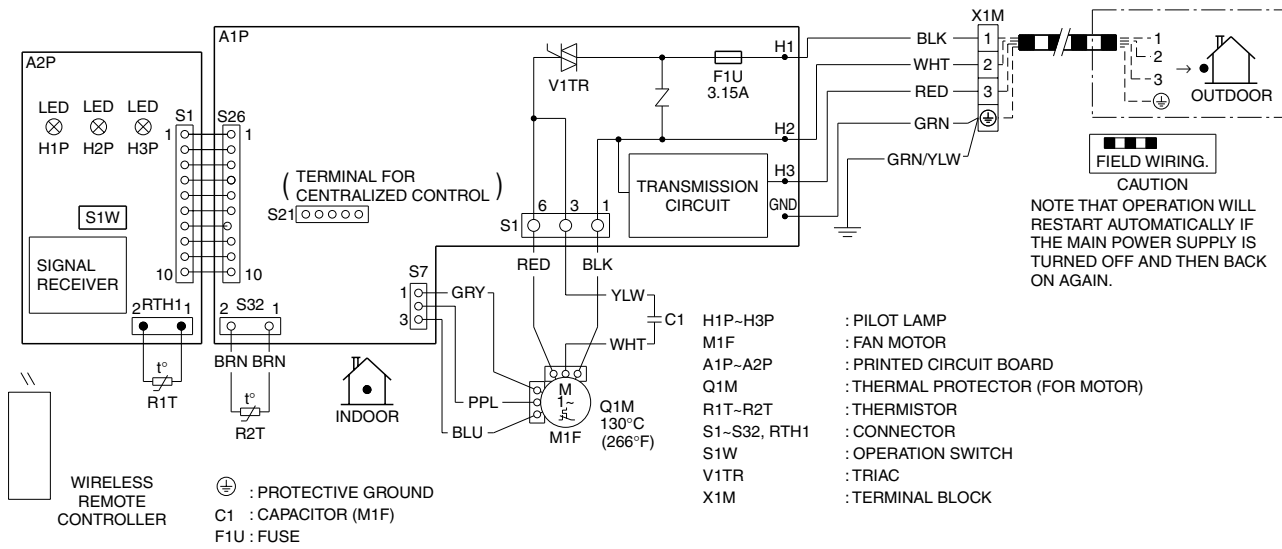

C: 3D073998B



Note: A1P: Control PCB
A2P: Display PCB
Refer to Part 3 for Printed Circuit Board Connector Wiring Diagram.

FVXS09/12/18NVJU

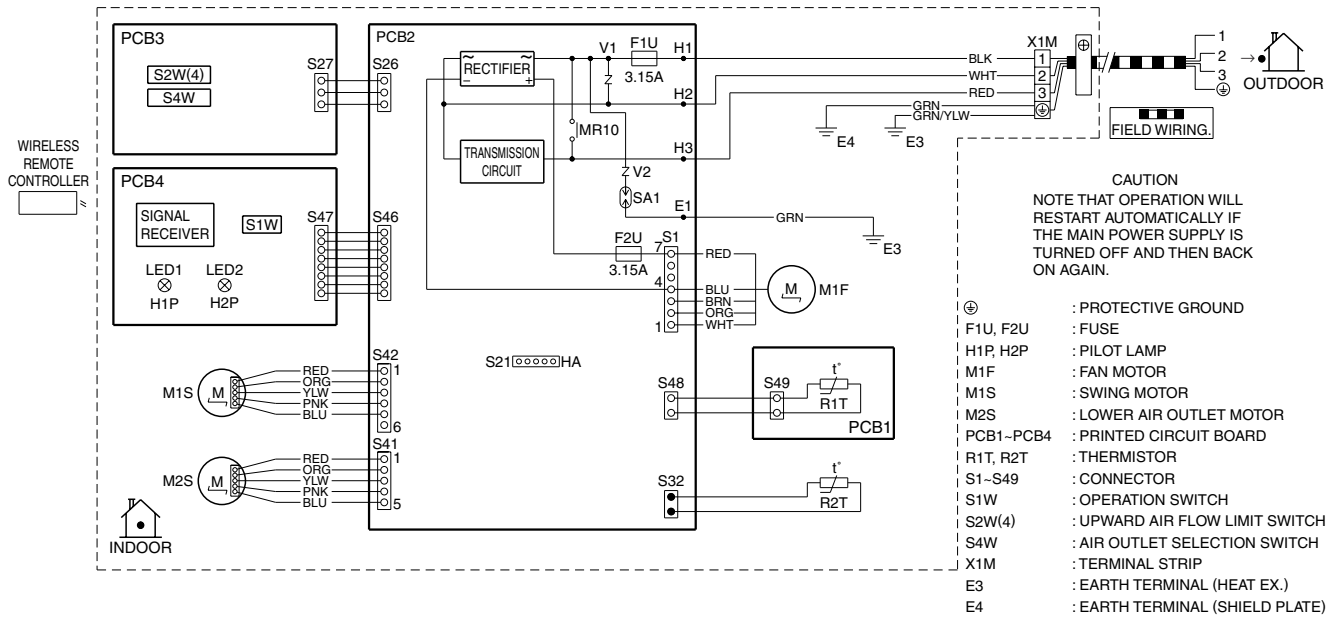

3D090604



Note: PCB1: Sensor PCB
 PCB2: Control PCB
 PCB3: Service PCB
 PCB4: Display PCB
 Refer to Part 3 for Printed Circuit Board Connector Wiring Diagram.

FFQ09/12/15/18LVJU

A1P	PRINTED CIRCUIT BOARD	H1P	PILOT LAMP (ON-RED)
C1	CAPACITOR (M1F)	H2P	PILOT LAMP (TIMER-GREEN)
F1U	FUSE (F. 5A, 250V)	H3P	PILOT LAMP (FILTER SIGN-RED)
HAP	PILOT LAMP (SERVICE MONITOR GREEN)	H4P	PILOT LAMP (DEFROST-ORANGE)
KPR	MAGNETIC RELAY (M1P)	SS1	SELECTOR SWITCH (MAIN/SUB)
M1F	FAN MOTOR	SS2	SELECTOR SWITCH (WIRELESS ADDRESS SET)
M1S	DRAIN PUMP MOTOR	X24A	CONNECTOR (WIRELESS REMOTE CONTROLLER)
M1S	SWING LOUVER MOTOR	X33A	CONNECTOR (ADAPTOR FOR WIRING)
Q1M	THERMAL PROTECTOR FOR MOTOR	X35A	CONNECTOR (GROUP CONTROL ADAPTOR)
R1T	THERMISTOR (AIR)	X40A	CONNECTOR (ON/OFF INPUT FROM OUTSIDE)
R2T	THERMISTOR (COIL-1)		
R3T	THERMISTOR (COIL-2)		
S1L	FLOAT SWITCH		
T1R	TRANSFORMER (208-230V/25V)		
V1TR	TRIAC		
X1M	TERMINAL BLOCK		
X2M	TERMINAL BLOCK		
TC	SIGNAL TRANSMISSION CIRCUIT		
BC	SIGNAL RECEIVER CIRCUIT		
W1R	WIRED REMOTE CONTROLLER (RECEIVER/DISPLAY UNIT)		
R1T	THERMISTOR (AIR)		
A3P	PRINTED CIRCUIT BOARD		
A4P	PRINTED CIRCUIT BOARD		
BS1	PUSH BUTTON SWITCH (ON/OFF)		

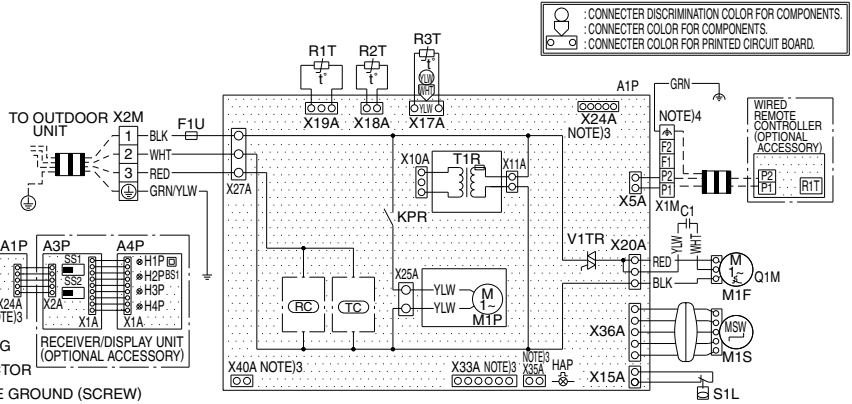

○ : CONNECTOR DISCRIMINATION COLOR FOR COMPONENTS.
 □ : CONNECTOR COLOR FOR COMPONENTS.
 □ : CONNECTOR COLOR FOR PRINTED CIRCUIT BOARD.

NOTES)
 1. □ : TERMINAL
 □ : FIELD WIRING
 □ : CONNECTOR
 ⊕ : PROTECTIVE GROUND (SCREW)
 ⚡ : NOISELESS GROUND

- IN CASE USING CENTRAL REMOTE CONTROLLER, CONNECT IT TO THE UNIT IN ACCORDANCE WITH THE ATTACHED INSTALLATION MANUAL.
- X24A, X33A, X35A AND X40A ARE CONNECTED WHEN THE OPTIONAL ACCESSORIES ARE USED.
- GROUND THE SHIELD OF THE REMOTE CONTROLLER CORD TO THE INDOOR UNIT (IN CASE OF USING SHIELD WIRE).
- SYMBOLS SHOW AS FOLLOWS: RED: RED BLK: BLACK WHT: WHITE YLW: YELLOW GRN: GREEN BLU: BLUE

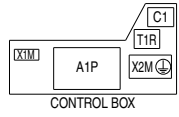

C: 3D080351A

Note: For the location of the switch (SS1) on the control PCB (A1P), refer to page 26.

2.2 Outdoor Unit

2MXS18NMVJU

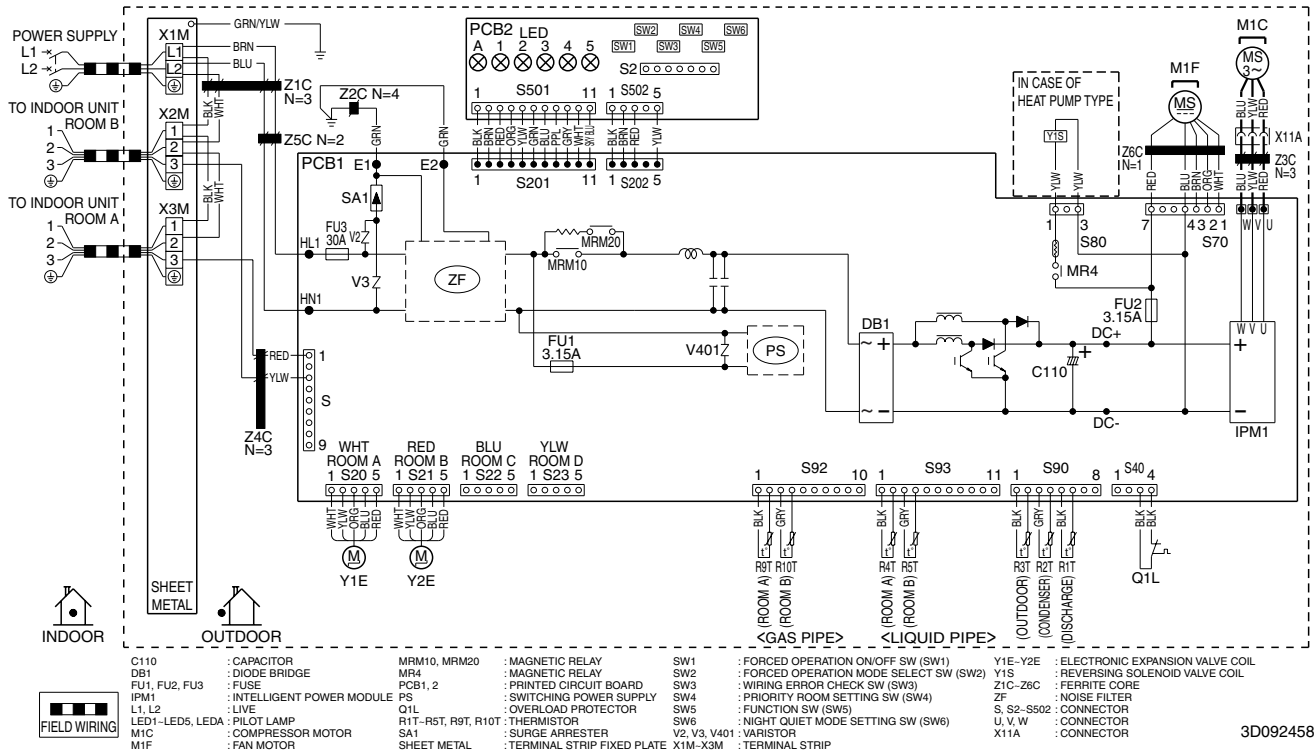

3D092458



Note: PCB1: Main PCB
 PCB2: Service monitor PCB
 Refer to Part 3 for Printed Circuit Board Connector Wiring Diagram.

3MXS24NMVJU

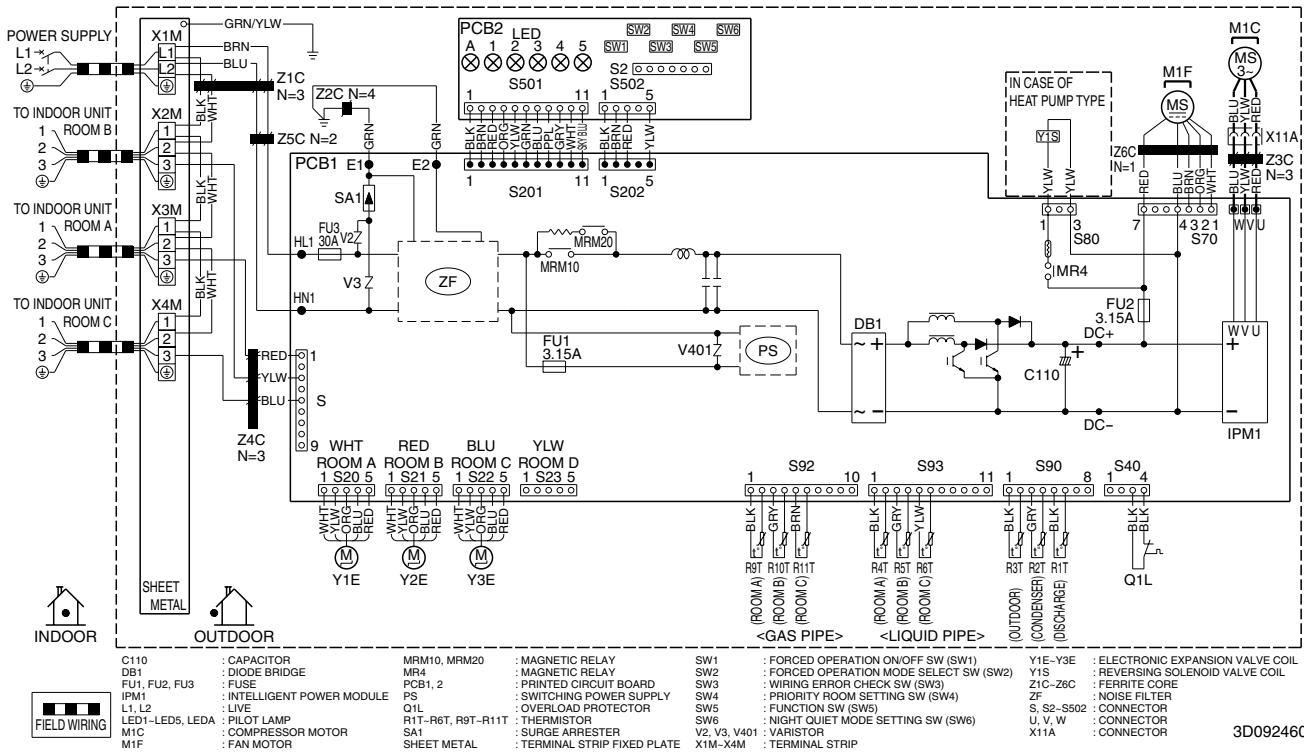

Note: PCB1: Main PCB
 PCB2: Service monitor PCB
 Refer to Part 3 for Printed Circuit Board Connector Wiring Diagram.

4MXS36NMVJU

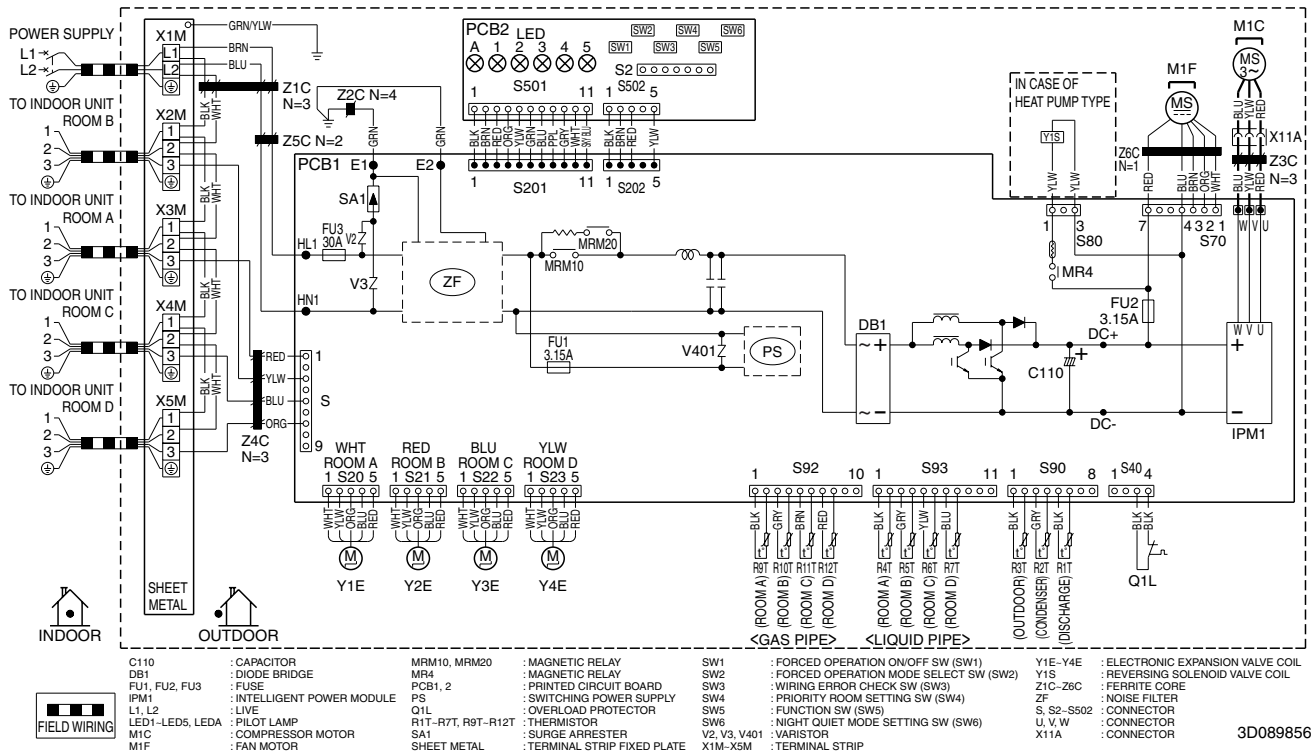

Note: PCB1: Main PCB
 PCB2: Service monitor PCB
 Refer to Part 3 for Printed Circuit Board Connector Wiring Diagram.

Revision History

Month / Year	Version	Revised contents
07 / 2015	SiUS121502E	First edition

Warning



- Daikin products are manufactured for export to numerous countries throughout the world. Prior to purchase, please confirm with your local authorized importer, distributor and/or retailer whether this product conforms to the applicable standards, and is suitable for use, in the region where the product will be used. This statement does not purport to exclude, restrict or modify the application of any local legislation.
- Ask a qualified installer or contractor to install this product. Do not try to install the product yourself. Improper installation can result in water or refrigerant leakage, electrical shock, fire or explosion.
- Use only those parts and accessories supplied or specified by Daikin. Ask a qualified installer or contractor to install those parts and accessories. Use of unauthorized parts and accessories or improper installation of parts and accessories can result in water or refrigerant leakage, electrical shock, fire or explosion.
- Read the user's manual carefully before using this product. The user's manual provides important safety instructions and warnings. Be sure to follow these instructions and warnings.

If you have any inquiries, please contact your local importer, distributor and/or retailer.

Cautions on product corrosion

1. Air conditioners should not be installed in areas where corrosive gases, such as acid gas or alkaline gas, are produced.
2. If the outdoor unit is to be installed close to the sea shore, direct exposure to the sea breeze should be avoided. If you need to install the outdoor unit close to the sea shore, contact your local distributor.

Dealer

© All rights reserved

● Specifications, designs and other content appearing in this brochure are current as of July 2015 but subject to change without notice.