

# V16 Automatic Shaker Unit

## Installation, Operations & Maintenance Manual



# **GARMENT PRINTER INK**





Dear Customer,

Congratulations on deciding to choose an STS adhesive shaker unit for your DTF printing activities. You made an excellent choice.

When you need service or technical help, please let us know your purchase invoice number. This will make it easier to provide you with correct service.

For your convenience, space is provided below for you to record your local STS service contact information.

STS TECHNICAL TEAM

Service number: 561-999-8818

email: [support@stsinks.com](mailto:support@stsinks.com)



**Contact Us: (631) 858-0114 | [sales@garmentprinterink.com](mailto:sales@garmentprinterink.com) | [www.garmentprinterink.com](http://www.garmentprinterink.com)**  
375 Oser Ave, Hauppauge, NY 11788



## 1. General

Carefully read the instructions in this manual as they contain important information regarding proper, efficient and safe installation, use and maintenance of the unit.

The installation of this unit must be carried out in accordance with the manufacturer's instructions.

Switch off the unit in case of failure or malfunction and contact your distributor for service information.

### 1.1 Symbols that may be used in this manual



This symbol informs about a situation where a safety risk might be at hand. Given instructions are mandatory in order to prevent injury.



This symbol informs about the right way to perform in order to prevent bad results, appliance damages or hazardous situations.



This symbol informs about recommendations and hints that help to get the best performance out of the appliance.





## 2. Safety

### 2.1 Safe use of the appliance



For your safety. Do not store or use gasoline or other flammable vapors or liquids in the vicinity of this or any other appliance.

### 2.2 Other prohibitions (dangerous procedures)



Using any parts other than genuine STS approved manufactured parts can void the warranty.



Improper installation, adjustment, alteration, service or maintenance can cause property damage or major injury. Read the installation and operating instructions thoroughly before installing or servicing this equipment.





## 3. Functional description

### 3.1 General

#### STS Auto shakers are:

- Electrically heated
- Heated by infrared tubes
- Have both auto/manual interface
- Mesh belt driven
- Electronically controlled
- Automatically sensor controlled
- Can be operated independently or together with a DTF printer





# GARMENT PRINTER INK



1. Powder box

#### Maintenance note\*

Keep powder box free from debris that mixes in with TPU powders. Brush unwanted material from powder box area daily and remove unwanted debris from recycle bin before reuse into powder box.





# GARMENT PRINTER INK

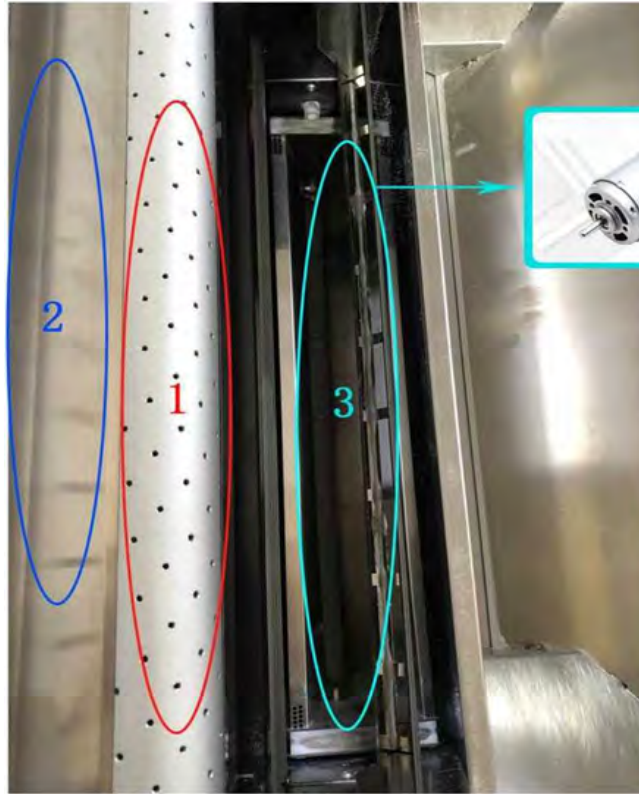

1. Vacuum Cylinder
2. Mesh Belt
3. High Frequency Powder removal System



1. Vented oven lid
2. Vacuum cooling cylinder
3. Cooling fans
4. Motorized take-up reel



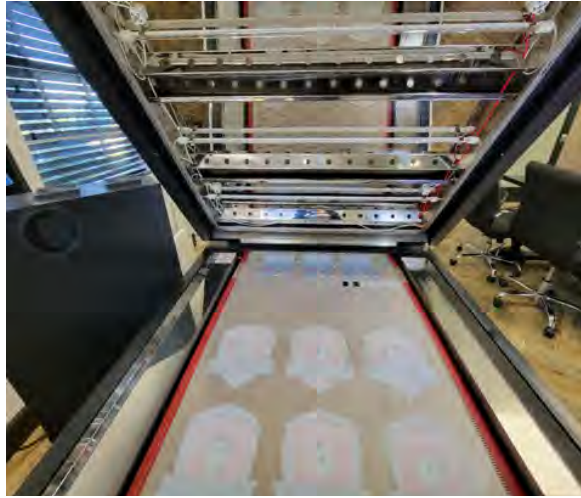

#### Maintenance note\*

With the vented oven lid in the open position and the unit unplugged, fix the lid in place using the securing arm. Then using a dry paper towel....

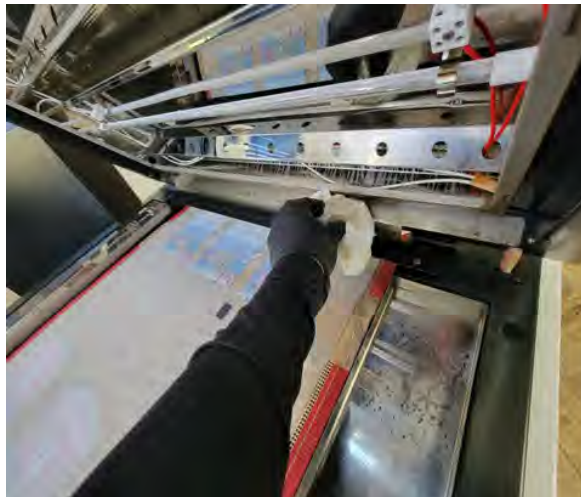

remove any oily residue from surfaces inside the heating chamber every week.



Also wipe the interior of the two-zone filtration system and housings by opening heating chamber filter panel.

Use the supplied hex key to unlock both top and bottom fixtures. Be careful not to jolt open the door as there are no installed hinges. Simply pull open 6 inches then lift up slightly to remove door for access.







Maintenance note\*

The two-zone HEPA and charcoal filters should be replaced as needed. With regular use each filter lasts approximately 3-4 months.



To remove and replace filters, unscrew interior locking nuts (black tops) and slide each filter upward to remove. Do the opposite to replace then affix door and seal with key locks.

2 zone filtration device includes both charcoal and HEPA filtration.





# GARMENT PRINTER INK

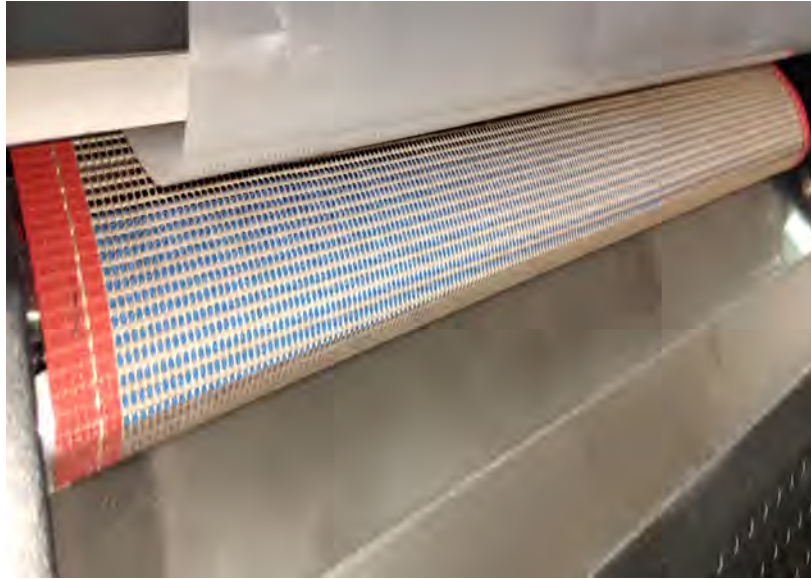

Mesh guide belt



Recycled powder tray

#### Maintenance note\*

Always remove any unwanted material from the recycled powder tray upon inspection. TPU powder should be completely white and sediment-free.



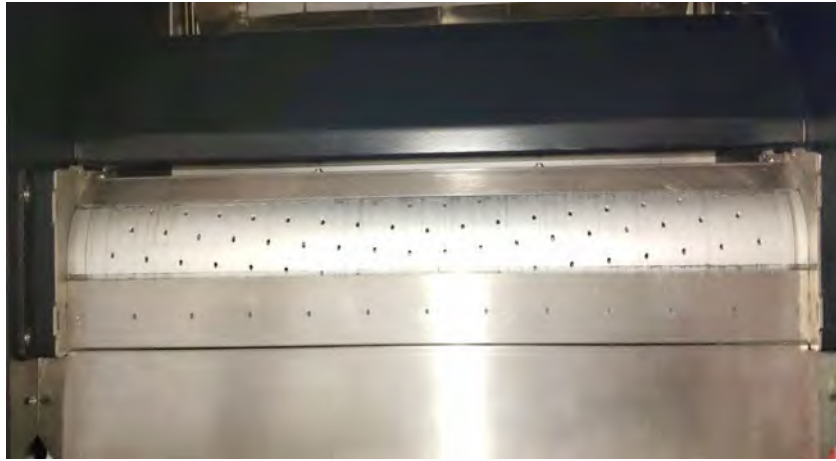

Maintenance note\*

After each daily workflow using 2000 grit sandpaper, gently sand across the vacuum cylinder to remove any surface buildup which may have occurred. This will ensure proper gripping of the PET film through the system.

Vacuum cylinder



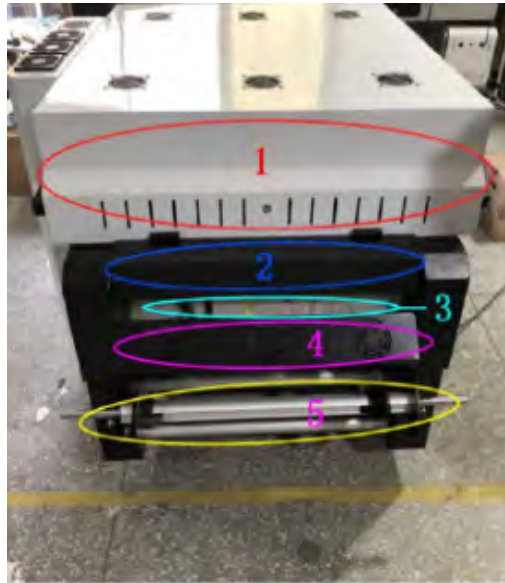

1. Oven
2. Insulation Baffle
3. Suction Cooling Unit
4. Cooling Fans
5. Powered Take-up Reel



1. Front Preheating Board and 2) Fans





## 4. Operations instructions

### 4.1 Before using the unit

Before you begin to use your new shaker oven you must understand the differences between an automatic shaker and a dialed manual one. You will produce better re-sults if you understand the technology and follow the “rules”.

- 4.2 **The V16** operates in both automatic and manual modes as selected by the user on the PLC touch screen.

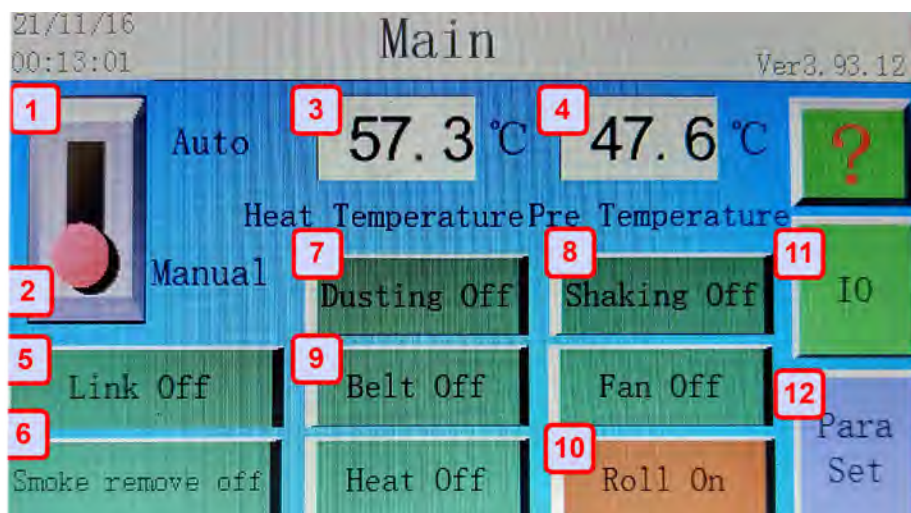

- (1) & (2) **The automatic/manual modes** control the complete operation of the STS 1600.  
 (2)The manual mode allows the user manually control the switches of each device function of the unit
- (3) **Heating temperature control** (actual)  
 (4) **Preheating temperature** controls the front heating plate (actual)  
 (5) **Print linkage** engages the front sensor, front vacuum cylinder and shaking device in automatic mode  
 (6) **Smoke remove switch** engages the internal filtration system  
 (7) **Dusting off** switch controls the opening and closing of the powder spreader  
 (8) **Shaking off** switch controls the on and off functions of the powder shake element  
 (9) **Mesh belt off** switch controls the heating of the conveyor belt  
 (10) **Roll on switch** controls the functions of the take up reel



- (11) **IO** allows the user to enter the monitoring interface
- (12) **Para set** allows the user to enter the parameters settings

### 4.3 Monitoring Interface



- (1) **X0** denotes the operation of the sensor under the preheating platform stays white when it senses media feeding, and turns red when it does not sense media. The white and red lights are standard throughout the IO Interface where white is off and red is on.
- (2) **X3** denotes the operation of the sensor when the film has passed through the shaker to the take up reel
- (3) **906** whether the belt is working, the red light is on. The white light will show when it is off
- (4) **904** belt on, or **906** belt off refers to the mesh conveyor belt operation. Red denotes on and white denotes it is off
- (5) Essentially the red on and white off shows the user what systems are currently engaged and those that are not. If the unit is in auto mode it will turn on and off systems depending on operating characteristics.
- (6) **Powder weight - Calibrate to 19-21 with no powder using slight pressure on the scale. When in operation be sure that powder weight is above 170 to pull PET film through the system. Add powder if below 170 or the system will not activate vacuum cylinder roller.**

### 4.4 System Parameters

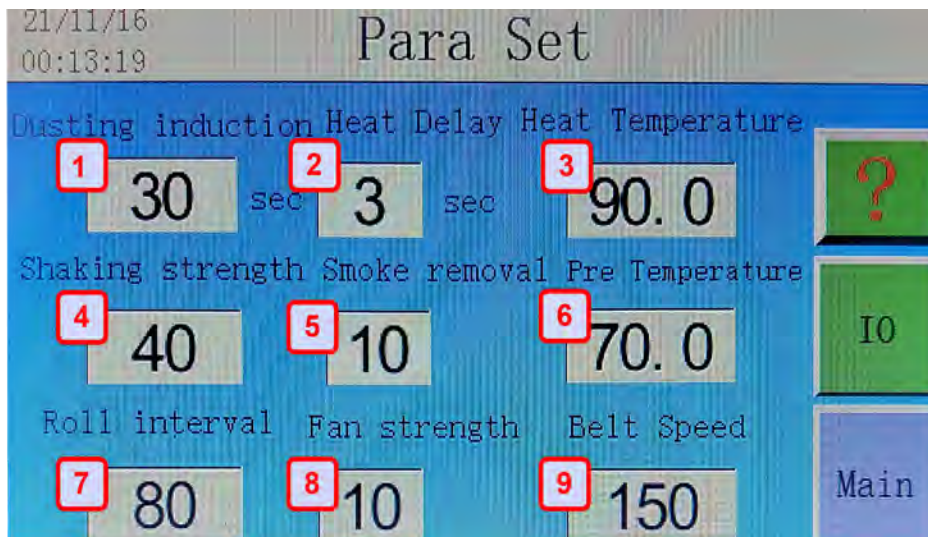

- (1) **Dusting induction** is set with a timing alarm that sounds after the powder spreading time is reached
- (2) **Heating delay** sets the heating delay time when the heating function is in the off position, time can be extended according to the new set time
- (3) **Heat temperature** of the infrared heating tunnel is set according to the melting temperature of the adhesive powder
- (4) **Shaking strength** adjusts the shaking strength of the powder removal sequence
- (5) **Smoke removal** adjusts the air purification unit intensity
- (6) **Preheating temperature** of the front heating plate can be set
- (7) **Take up speed** is set when the larger the value the slower the speed
- (8) **Suction strength** is set after entering the printing linkage mode. Click to set the suction strength of the 2 vacuum cylinders (front and rear)
- (9) **Mesh belt** speed controls the speed of the conveyor belt in which the larger the value the faster the running speed

## 5.0 Operational Procedures

Once the printer has printed enough transfers to cover the front preheating board and the media extends to the first of two vacuum cylinders (pg. 6) ensure that the PET transfer media is aligned correctly to inhibit any skew that may be present through the heating tunnel and take-up reel.

When the media is placed correctly to the first vacuum cylinder the shaker suction system should be in the on position. From this point the media will now be controlled by both the vacuum and mesh belt system through the heating tunnel (pg. 7). It is important to note that when placing the media under the powder hopper for the first time that enough slack is provided to allow powder to fill at the bottom and then be shaken off as the the media moves back up through the belt system (below).

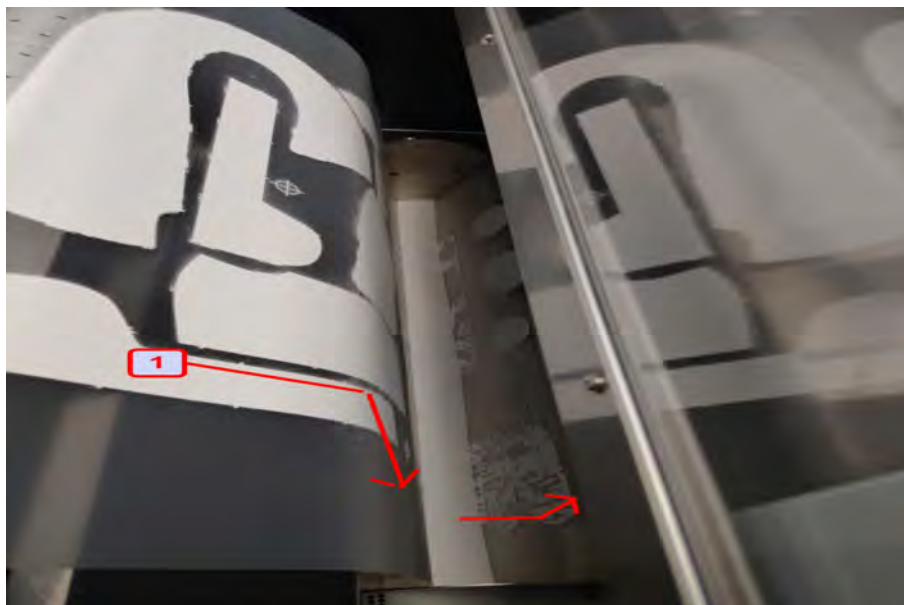



After finishing the current print job, cut the last part of PET media and enter the print linkage mode. The film will then be automatically wound by the take-up to complete the printing process.

**Recycling the hot melt powder** is accomplished simply by brushing the powder from the interior walls into the recycled powder tray (pg.7) and refill it into the powder box (pg. 4).







# GARMENT PRINTER INK

## 5.3 Electrical Wiring Diagrams

Cable 12-220v single phase 30  
AMP

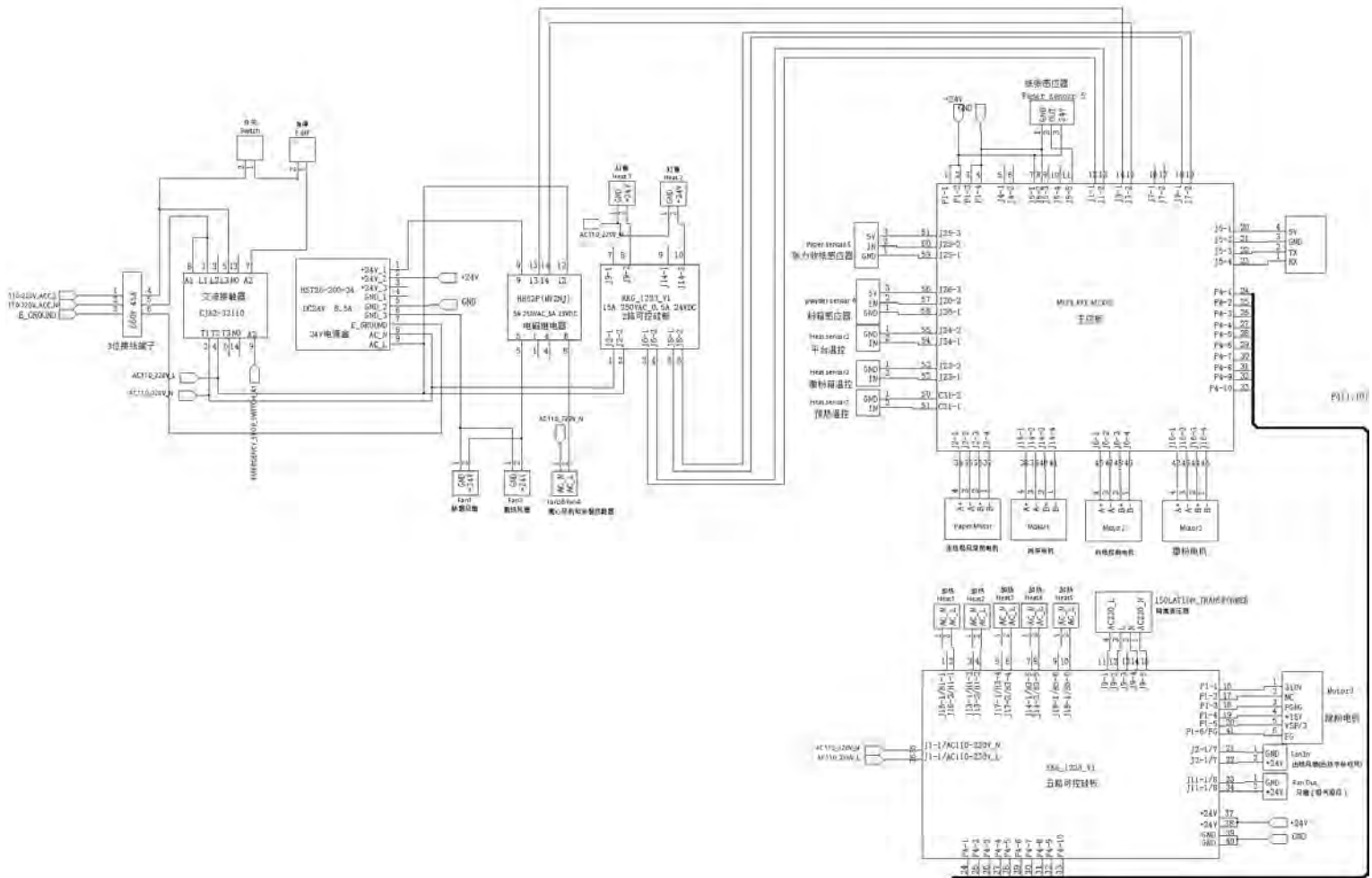



# GARMENT PRINTER INK

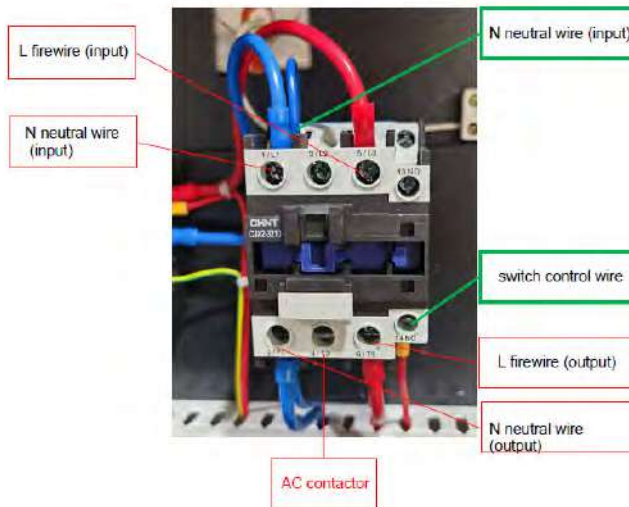
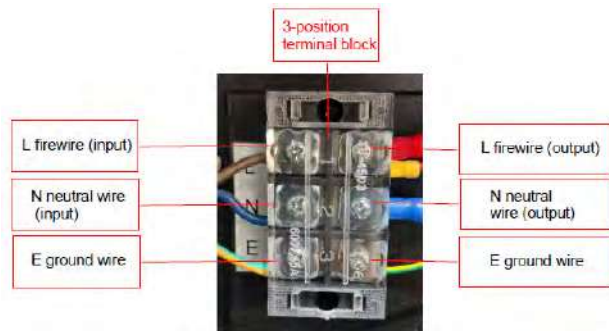
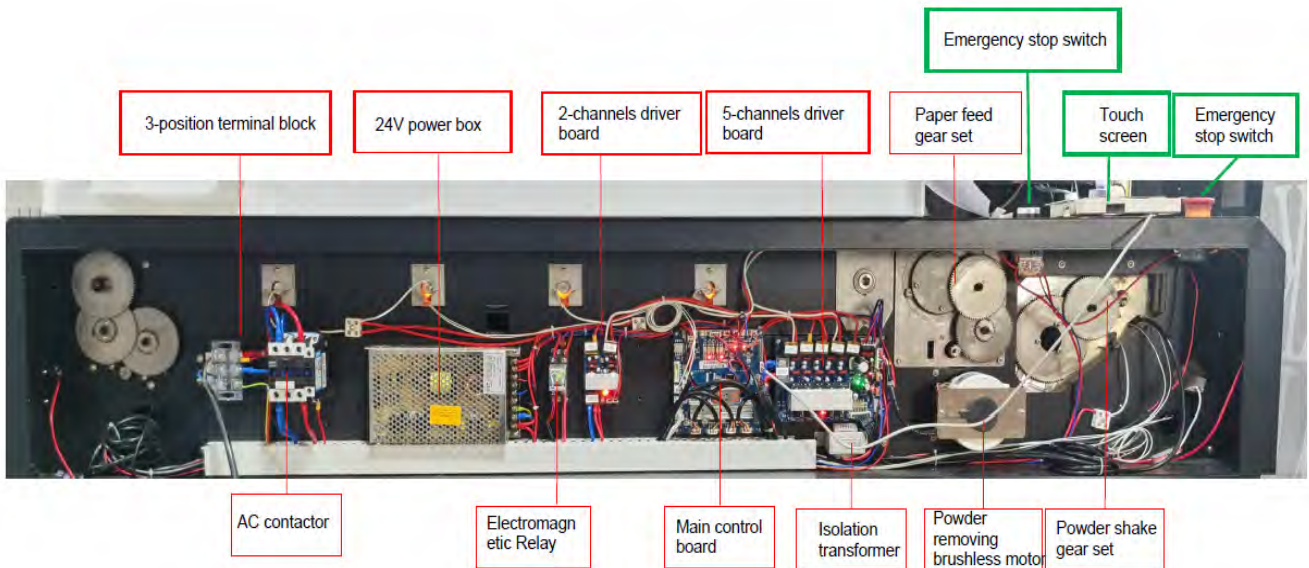



# GARMENT PRINTER INK

24V power  
box

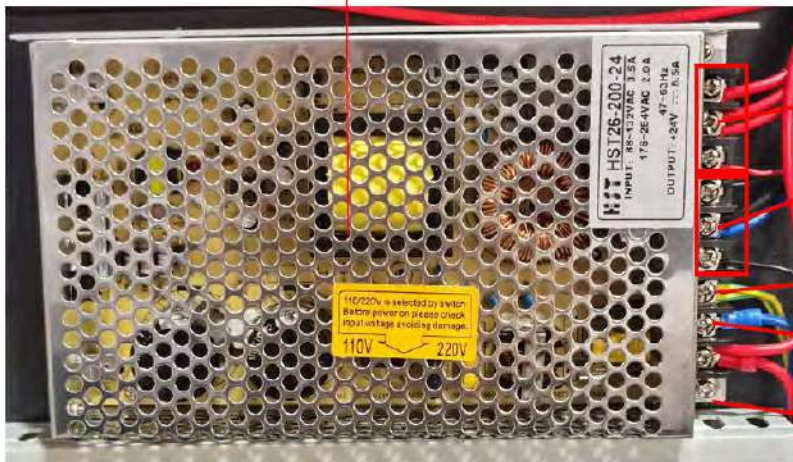

+24V (output)

GND

E ground wire  
(common ground)

N neutral wire (input)

L firewire (input)

GND (13)

Smoke removal cooling  
fan input (9)

Smoke removal cooling  
fan output (5)

+24V Power Cord(14)

Smoke removal  
centrifugal fan input(12)

Smoke removal  
centrifugal fan output(8)

Preheat (lamp line)

L firewire (input)

N neutral wire  
(input)

Upper heating 1  
(lamp line)

Upper heating 1 control  
wire (signal wire)

Preheat control  
wire (signal wire)







# GARMENT PRINTER INK

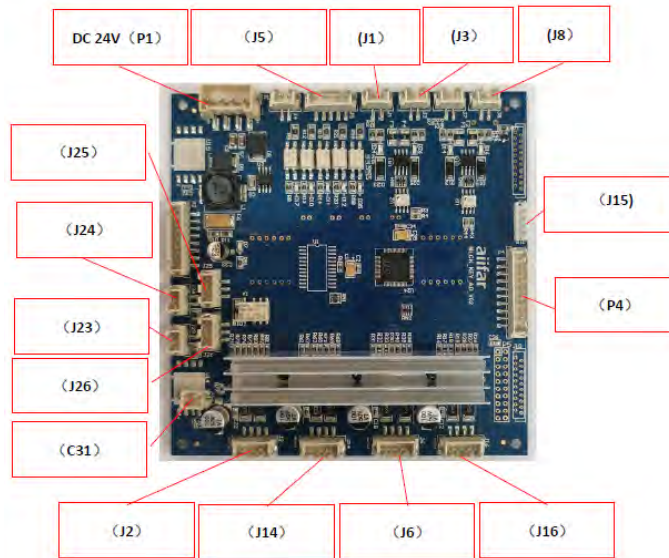

P1	DC24V	J5	Input sensor
J1	Upper heating control wire	J3	Smoke removal style effect control switch wire
J8	Preheat	J25	Tension take-up reel sensor
J24	Platform temperature control	J23	Powder shake box temperature control
J26	Powder box sensor	C31	Preheat temperature control
J15	Show line	P4	Main board control wire
J2	Routing suction roller	J14	Take-up reel control
J6	Conveyor belt	J16	Powder shake motor

P1	1	+24V	
	2	+24V	
	3	GND	
	4	GND	

J15	1	24V	
	2	GND	
	3	Null	
	4	Null	
	5	Input sensor signal	

J1, J3, J7 J8	1	+24V signal output	
	2	GND	

J24, J23, C31	1	GND	
	2	Temperature sensing signal input	

J25, J26	1	5V	
	2	Temperature sensing signal input	
		GND	

J2, J14, J 6, J16	1	A+	
	2	A-	
	3	B+	
	4	B-	





# GARMENT PRINTER INK

