

For detailed instructions, please refer to the Uninet iColor 650 Printer User Manual and the Uninet iColor ProRIP User Manual

### 1. Remove the packing materials and check the components

Uninet iColor ProRIP dongle



Uninet iColor 650

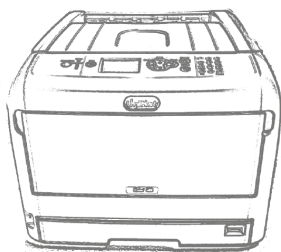

### 2. Open the front door and top lid of the printer

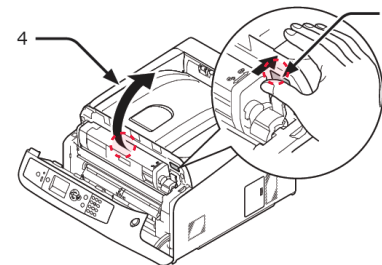
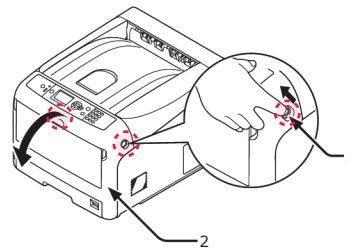

### 3. Uninstall the cartridges to remove the protective orange film from each.

- Lock the blue lever forward.
- Reinstall the cartridges.

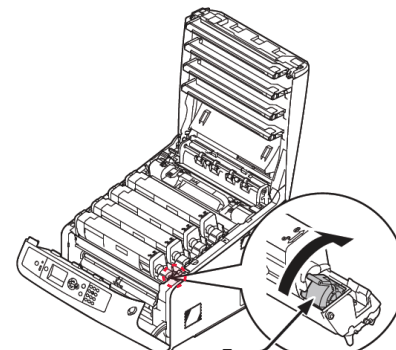
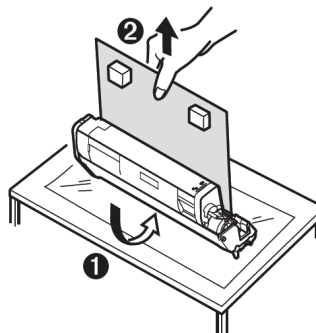
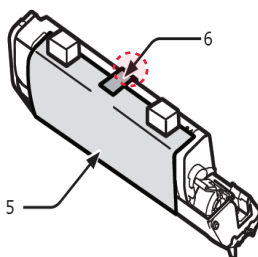
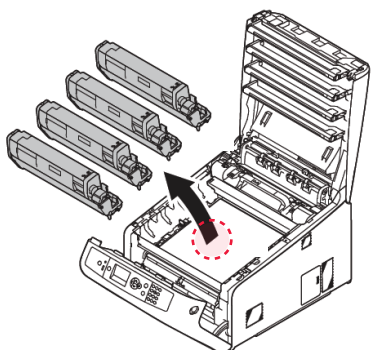

\* Please note the blue handle on the white cartridge is already in the locked position \*

### 4. Using one of the provided cables (Network or USB), connect the printer to your PC (USB) or router/switch (network).

- To set a static IP address for the printer, please refer to the iColor 650 User Manual.

### 5. The Uninet iColor 650 Digital Color + White Transfer Media Printer has THREE configurations to suit any printing project

These coincide with the 'Print Queues' in the iColor ProRIP (Step 13)

#### A. Standard CMYK

(Used for traditional CMYK Printing applications)



Slot Order (Front to Back)

#### B. Spot Color Underprinting

(Used for right side reading applications. Typically printing color on clear on dark papers) White prints first.



Slot Order (Front to Back)

#### C. Spot Color Overprinting

(Used for reverse printing applications. Typically garment decoration) White prints last.



Slot Order (Front to Back)

### 6. Install the Uninet iColor ProRIP (stored on the provided dongle)

- Choose your language and follow the install steps

**Please disable/uninstall any Anti Virus software before installation of the UNINET ProRIP**

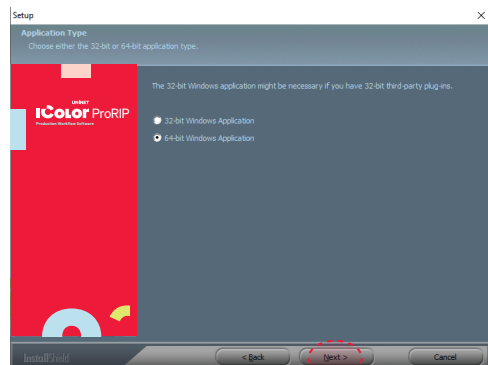

**Setup**  
Application Type. Choose either 32-bit or 64-bit application type. To Continue, select Next.

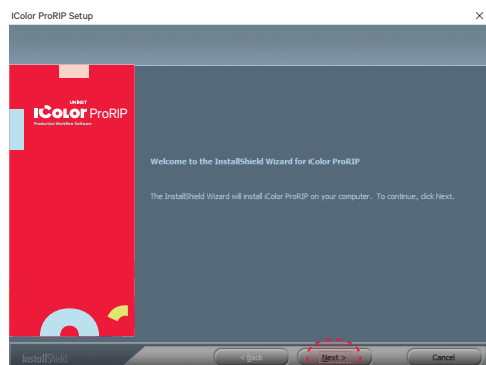

**iColor ProRIP Setup**  
InstallShield Wizard for iColor ProRIP  
The InstallShield Wizard will install iColor ProRIP on your computer. To Continue, select Next.

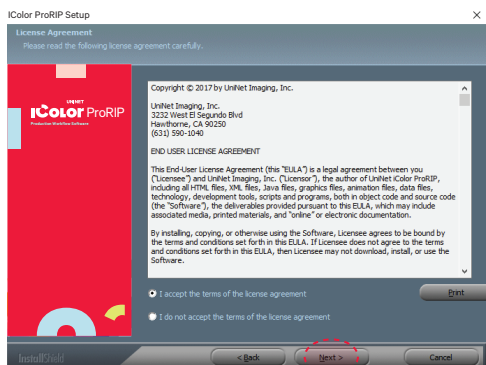

**iColor ProRIP Setup**  
License Agreement  
Please read the following license agreement carefully. If you agree, Accept and select Next.

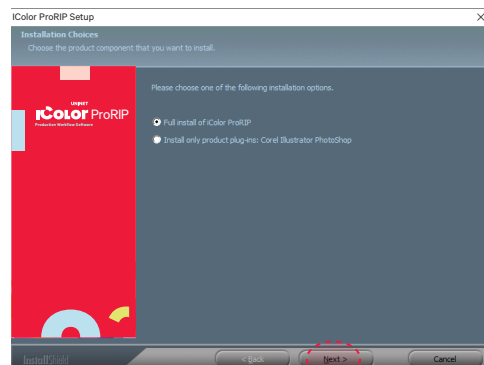

**iColor ProRIP Setup**  
Installation Choices  
Choose 'Full install of iColor ProRIP' and select Next.

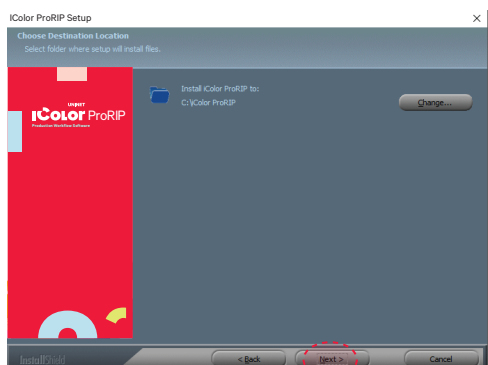

**iColor ProRIP Setup**  
Choose Destination Location. Select folder where setup will install files. To Continue, select Next.

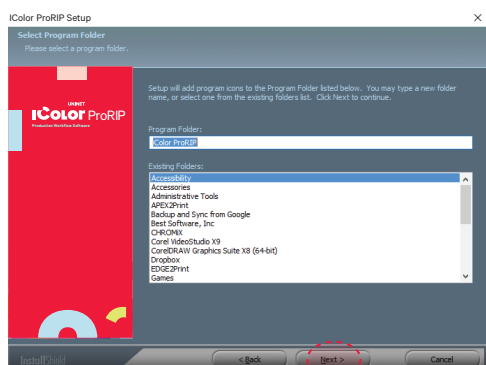

**iColor ProRIP Setup**  
Select Program Folder. Please select a program folder. Setup will add program icons to the Program Folder listed below. You may type a new folder name, or select one from the existing folders list. Select Next to continue.

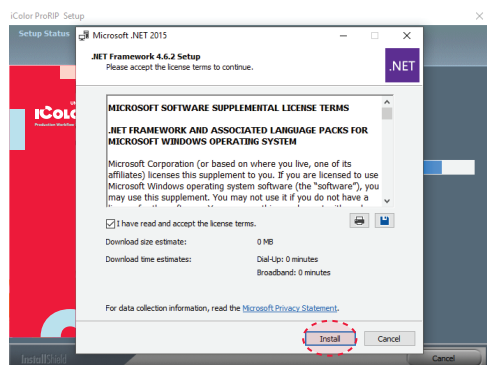

**iColor ProRIP Setup**  
Agree to license terms and select Install.

## 7. Uninet IColor ProRIP software

### First time Setup

- Ensure the ProRIP dongle is inserted and you are connected to the internet (required)
- Launch the software
- Set unit of measure and decimal places, then select OK.

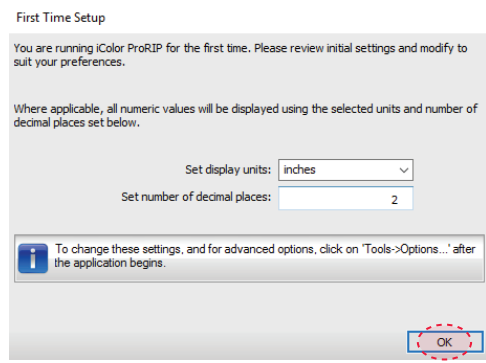

## 8. ProRIP opens, the Queue Wizard will begin the installation of the support files for your IColor 650 printer

- Select Next

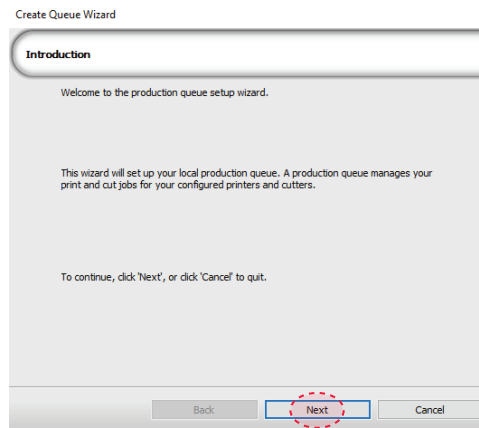

- Select Install Printer

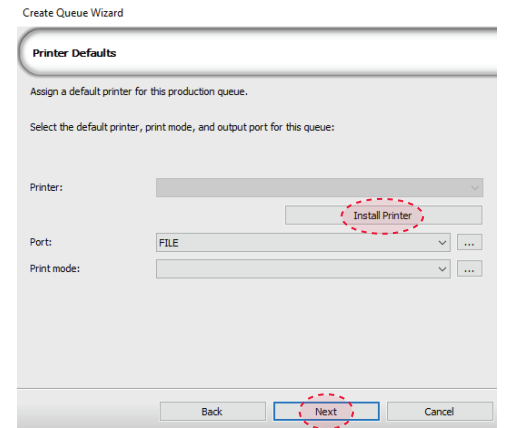

## 9. Select the IColor 650 printer from the support menu and select 'OK'

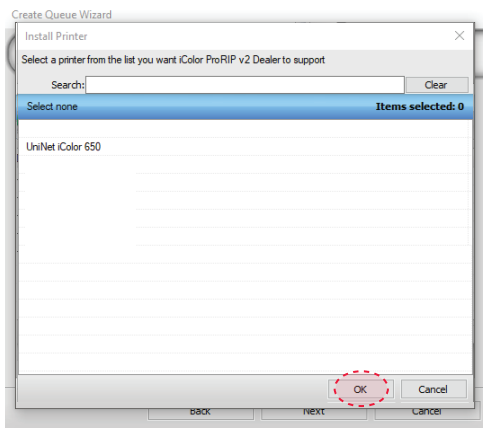

## 10. Device package Search

- Select 'Search' for new printer package
- Select 'Next' to continue the installation

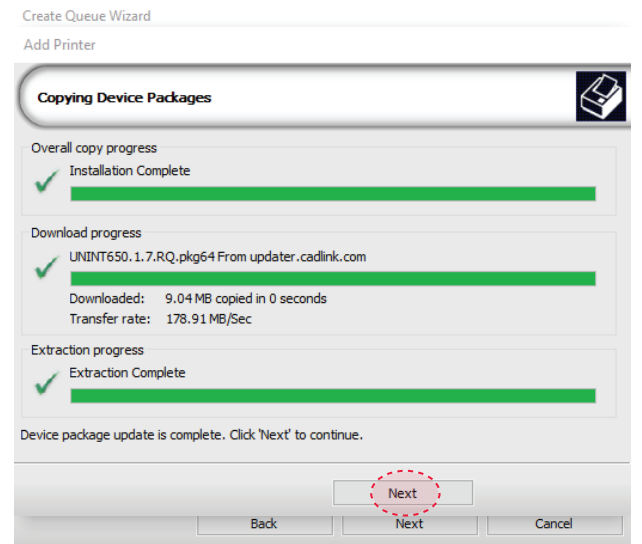
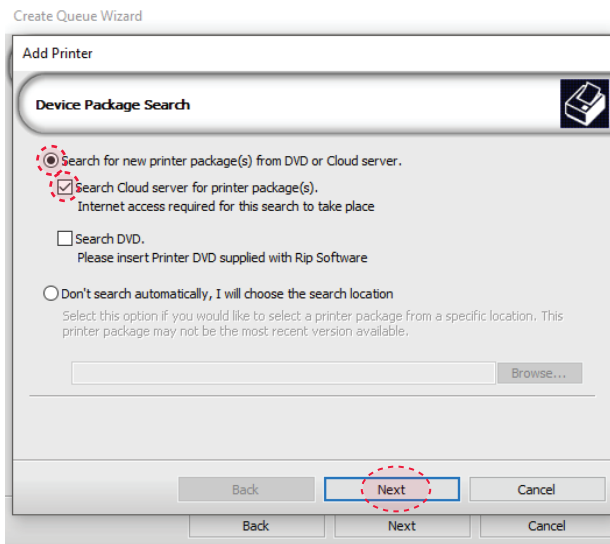

## 11. Select your 'Port' from the menu

- Network or USB (Choose TCP/IP for network)
  - If connected via USB, choose the printer as identified in the drop down menu.

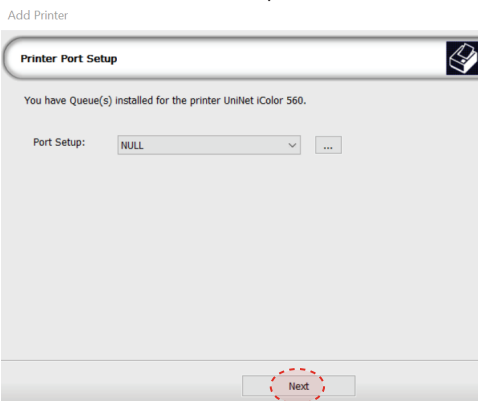

## 12. Port Configuration (network)

- If connected via network, once TCP/IP is selected, the software will poll your network for available printers.
- \*\*\* Be sure to set a static IP address for your printer so that the IP address does not change later. If this occurs, you will need to repeat this step\*\*\*

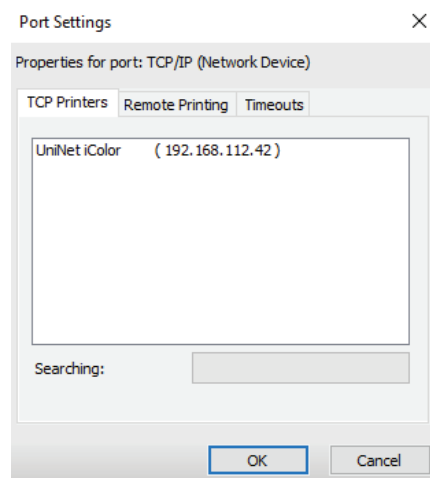

– If you need to change or reset the ports in the future: Click **Queue >> Manage Queues** to view, update or change the port settings.

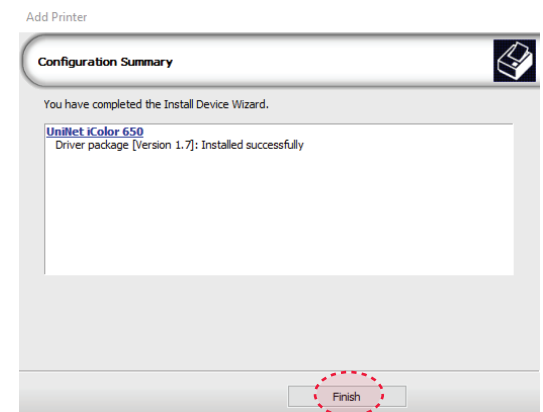

## 13. Select the proper Print Queue for your project

- A. Select your 'Print Que' and 'Print Mode'
  - The 'Print Modes' have preset values for white coverage, choke, paper size, paper tray and mirror settings

These can be modified as needed

**Note:** Preview icon should match the physical cartridge configuration of the printer.

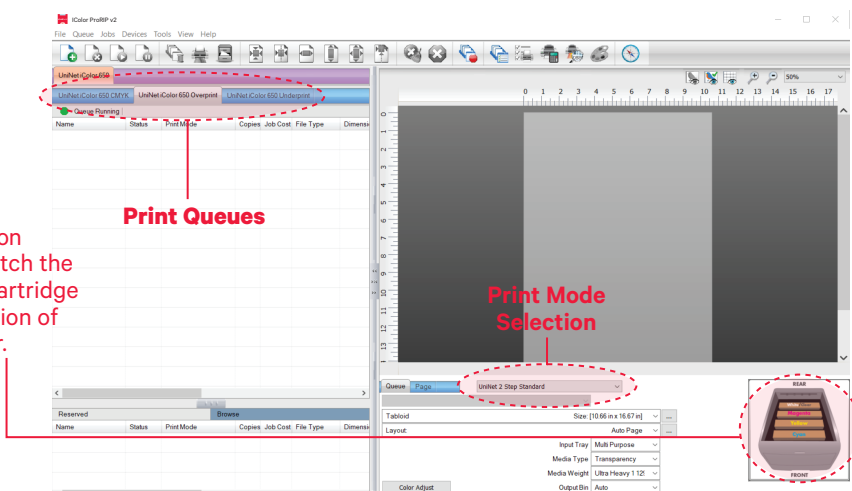

## 14. Import + Print Graphic

- A. Three ways to import graphics

1. Select the 'green plus' icon and navigating to the proper folder.
2. Select File > Import File
3. Simply dragging and dropping your file into the queue

- B. Select the desired file

- C. Select 'Print' icon in the menu bar.

