

[Skip to content](#)

**Manuals+**

User Manuals Simplified.



## Temperature and Humidity Monitor 2 User Manual

Home » [Mi](#) » Temperature and Humidity Monitor 2 User Manual 

Temperature and Humidity Monitor 2 User Manual



Read this manual carefully before use, and retain it for future reference.

## Contents [ [hide](#) ]

### 1 Product Overview

#### 1.1 Front View

#### 1.2 Rear View

### 2 Accessory

### 3 Installation

#### 3.1 Installing the Battery

### 4 Display Description

#### 4.1 Symbol Instructions

#### 4.2 Low Battery Notification

### 5 Smart Connection

#### 5.1 Connect with Other Devices

### 6 Restoring Factory Settings

### 7 Daily Care & Maintenance

### 8 Precautions

### 9 Specifications

### 10 File Downloads

### 11 References

### 12 Related Manuals

## Product Overview

### Front View

Top Ventilation Holes

Note:

Do not obstruct the ventilation holes when installing or using the monitor.

Lanyard Hole

Note:

To use the lanyard hole, remove the back cover of the monitor first.



Display

### Rear View

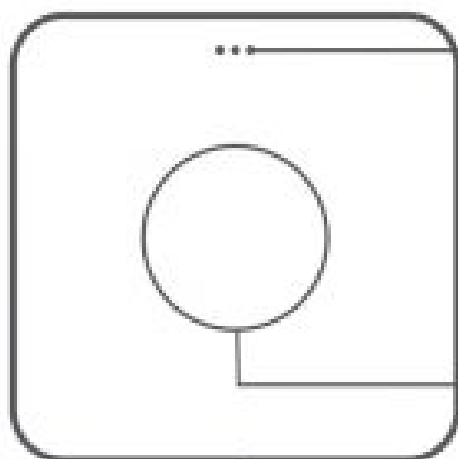

Rear Ventilation Holes

Note:

Do not obstruct the ventilation holes when installing or using the monitor.

Adhesive Area

Cover Opening

### Accessory



Adhesive Sticker

### Installation

#### Installing the Battery

Remove the cover from the cover opening of the monitor, and place a CR2032 battery with the positive (+) side facing upwards, then reinstall the cover.

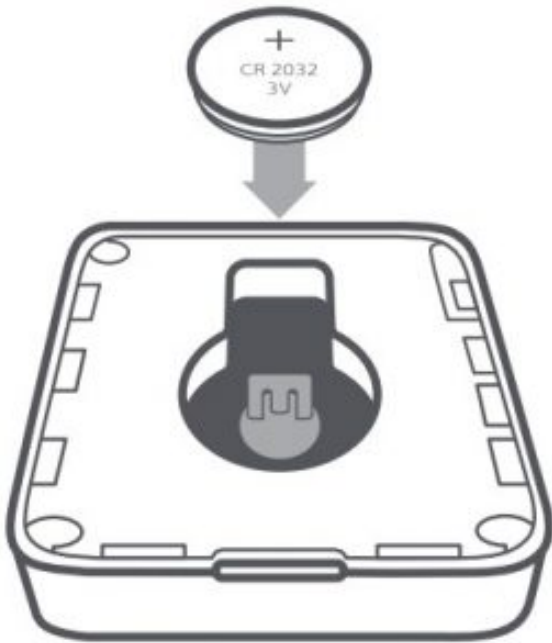

Note: Battery is not included and sold separately.

You can use and install your monitor in the following ways:

1. **Placing:** Directly place the monitor on the surface of the furniture such as table, bookshelf.
2. **Using the adhesive sticker:** Remove the release liner from one side of the adhesive sticker to stick it on the back of the monitor, then remove the release liner from the other side to stick it at the desired place on the wall.

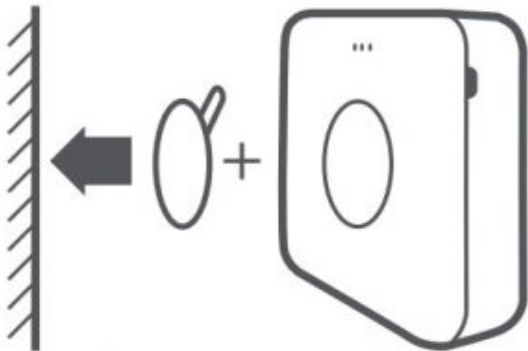

3. **Hanging:** Remove the back cover of the monitor, and lead the lanyard's loop through the hole and around the hook. Reinstall the back cover, then hang the monitor.

**Note: Lanyard is not included and sold separately.**

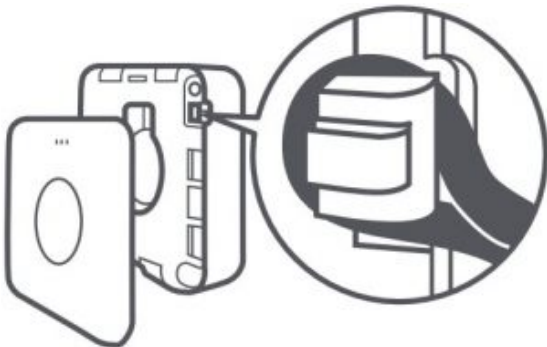

## Display Description

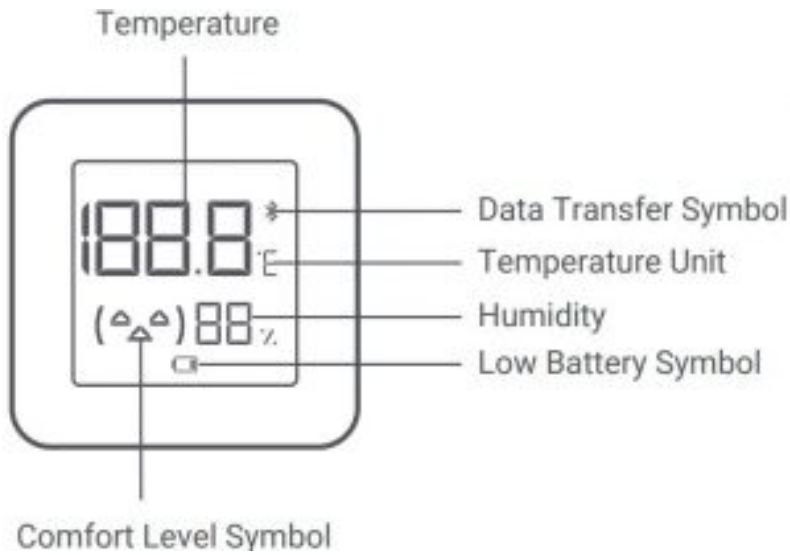

### Symbol Instructions

Temperature/Humidity	Less than 19°C	Between 19°C and 27°C	More than 27°C
Less than 20%	( - ^ - )	( - ^ - )	( - ^ - )
Between 20% and 85%	( - ^ - )	( ^ _ ^ )	( - ^ - )
More than 85%	( - ^ - )	( - ^ - )	( - ^ - )

### Low Battery Notification

When the battery is at a low level, this symbol appears on the display. Please replace the battery.



## Low Battery Symbol

### Smart Connection

#### Connect with Mi Home/Xiaomi Home App

This product works with Mi Home/Xiaomi Home app \*. Control your device, and interact it and other smart home devices with Mi Home/Xiaomi Home app.

Scan the QR code to download and install the app. You will be directed to the connection setup page if the app is installed already. Or search “**Mi Home/Xiaomi Home**” in the app store to download and install it.



Open Mi Home/Xiaomi Home app, tap “+” on the upper right, and then follow prompts to add your device.

- The app is referred to as Xiaomi Home app in Europe (except for Russia). The name of the app displayed on your device should be taken as the default.

**Note:** The version of the app might have been updated, please follow the instructions based on the current app version.

#### Connect with Other Devices

Make sure your temperature and humidity monitor is connected with Mi Home/Xiaomi Home app. Tap ” ” on the upper right corner of the monitor’s user interface, then follow the on-screen instructions to connect with other smart devices.

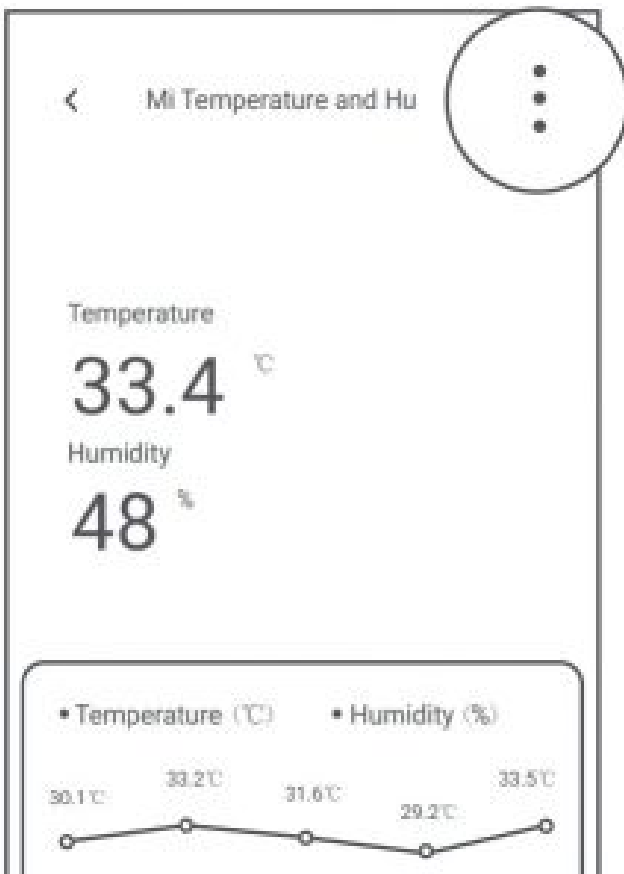

**Note:** The monitor can only connect with these devices supporting the function of Mi Bluetooth Gateway. Please contact the customer service for detailed information.

#### Restoring Factory Settings

Remove the back cover when the monitor is working normally, and use a conductive material to connect the two contact points above the battery for about 5–8 seconds. Once the monitor restarts, the factory settings have been restored and previously saved data has been cleared.

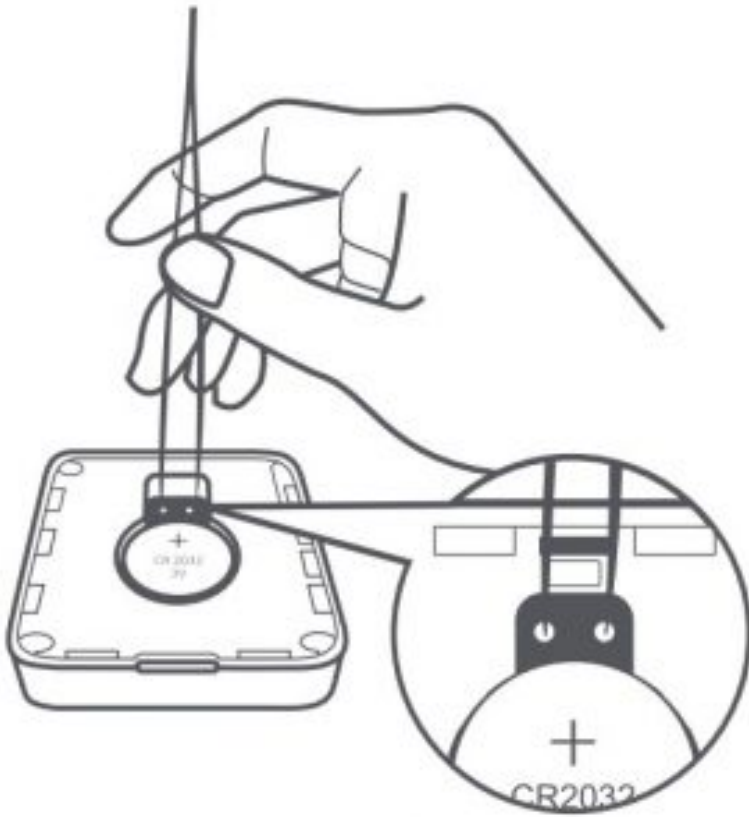

## Daily Care & Maintenance

- Please prevent water from getting into the monitor when cleaning it.
- When the surface of the monitor is dirty, it can be wiped clean using a damp soft cloth with some neutral detergent.

## Precautions

- Do not immerse the ventilation holes into any liquid.
- Do not remove the monitor from a wall with force if it is attached with the adhesive sticker, so as to avoid damage to the wall or the monitor.
- This monitor is not suitable for use in environments with temperatures below 0°C. Please keep it away from harsh environments with high temperatures or high humidity.
- This monitor is designed to facilitate a healthy lifestyle, but should not be used as a measuring tool.

## Specifications

<b>Name:</b>	Mi Temperature and Humidity Monitor 2
<b>Model:</b>	LYWSD03MMC
<b>Materials:</b>	ABS & PMMA
<b>Dimensions:</b>	43 × 43 × 12.5 mm
<b>Net Weight:</b>	18 g
<b>Operating Voltage:</b>	DC 2.5–3 V
<b>Battery Type:</b>	CR2032 (Not included)
<b>Wireless Connectivity:</b>	Bluetooth 4.2 Bluetooth Low Energy
<b>Frequency Range:</b>	2402MHz-2480MHz
<b>Maximum Output Power:</b>	4.16dBm
<b>Temperature Measurement Range:</b>	0°C to 60°C
<b>Temperature Accuracy:</b>	± 0.1°C
<b>Humidity Measurement Range:</b>	0–99% RH
<b>Humidity Accuracy:</b>	± 1% RH

**Note:** Illustrations of product, accessories, and user interface in the user manual are for reference purposes only. Actual product and functions may vary due to product enhancements.



Hereby, MiaoMiaoCe Technology (Beijing) Co., Ltd. declares that the radio equipment type LYWSD03MMC is in compliance with Directive 2014/53/EU. The full text of the EU declaration of conformity is available at the following internet **address:** <http://www.mi.com/global/service/support/-declaration.html>



All products bearing this symbol are waste electrical and electronic equipment (WEEE as in directive 2012/19/EU) which should not be mixed with unsorted household waste. Instead, you should protect human health and the environment by handing over your waste equipment to a designated collection point for the recycling of waste electrical and electronic equipment, appointed by the government or local authorities. Correct disposal and recycling will help prevent potential negative consequences to the environment and human health. Please contact the installer or local authorities for more information about the location as well as terms and conditions of such collection points.

**Visit:** [www.beryko.cz](http://www.beryko.cz)

## File Downloads



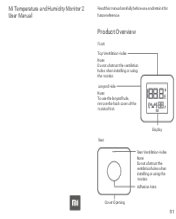

User Manual [Download](#) [optimized]  
Temperature and Humidity Monitor 2 [Download](#)

## References

- [Beryko.cz](http://Beryko.cz)
- [404 - Xiaomi Global](http://404 - Xiaomi Global)

## Related Manuals

1. [ACURITE Temperature & Humidity Monitor Instruction Manual](#) ACURITE Temperature & Humidity Monitor Instruction Manual Questions? Contact Customer...
2. [Mengshen Humidity Temperature Meter Wet Bulb Temperature Instruction Manual](#) Mengshen Humidity Temperature Meter Wet Bulb Temperature Product Overview This...
3. [EXTECH Temperature and Humidity Datalogger User Manual](#) EXTECH Temperature and Humidity Datalogger User Manual Additional User Manual...
4. [XY-WTH1 Temperature and Humidity Controller User Manual](#) XY-WTH1 Temperature and Humidity Controller Feature Model: XY-WTH1 Temperature range:...
5. [Accurite Outdoor Clock with Temperature and Humidity User Manual](#) ACURITE Outdoor Clock with Temperature and Humidity User Manual 1....
6. [diditech Temperature Humidity Weather Station User Manual](#) diditech Temperature Humidity Weather Station User Manual OVERVIEW MAIN UNIT...