

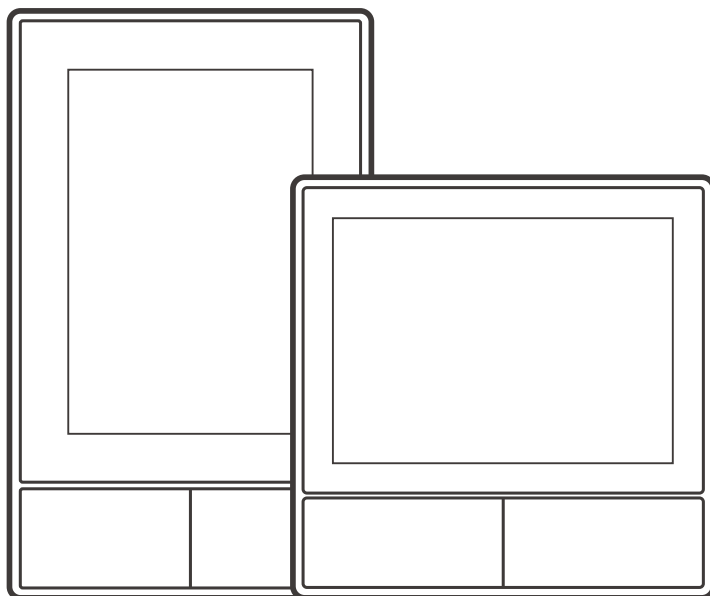

User manual V1.1



NSPanel-US

NSPanel-EU

SONOFF NSPanel Smart Scene Wall Switch

产品介绍

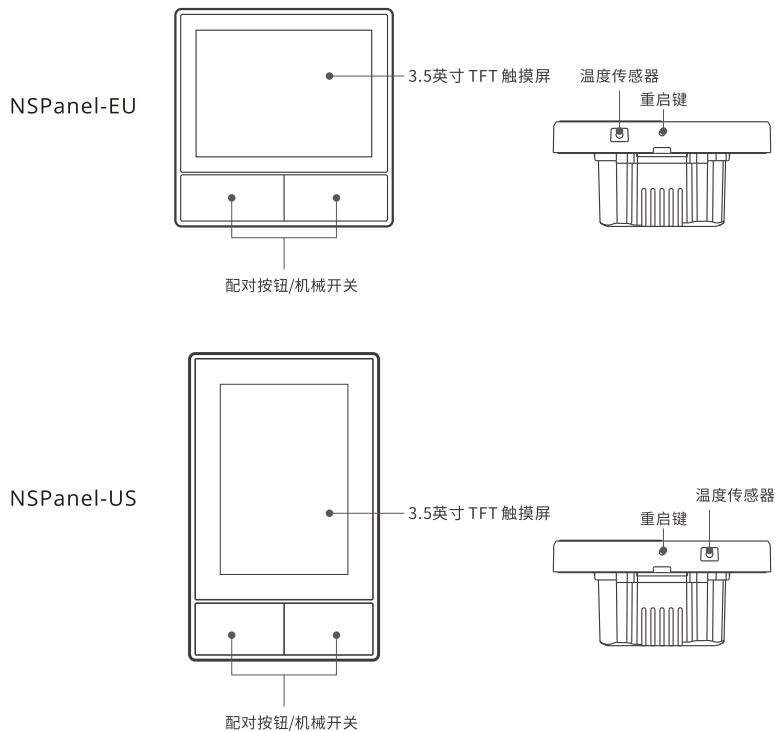

⚠ 设备重量 < 1Kg, 建议安装高度 < 2米。

功能特点

NSPanel 是一款融合了屏幕触控、语音、App 三种交互方式的双通道智能场景开关面板，添加温控器去控制易微联账户下关联的开关插座类设备（加热、制冷）。通过添加组件可对多个智能设备进行控制，用您的智能手机在任何地方打开或关闭家里的设备，设置定时开/关、分享给您的家人一起控制等等。



远程控制



智能定时/延时



语音控制



分享功能



3.5英寸 TFT 触摸屏



添加组件



智能场景



温控器



点动模式



互锁模式



群组功能



局域网功能

使用说明

1. 断电

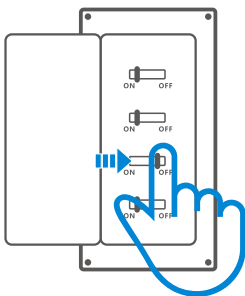

⚠ 设备安装、故障维修请由专业资质电工操作。切勿在设备通电时进行接线操作或触碰到接线端子，以免发生触电危险！

2. 接线

灯具接线示意：

NSPanel-EU

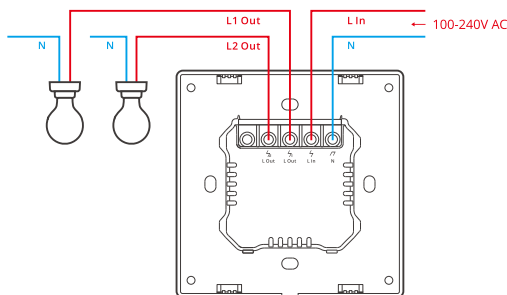

NSPanel-US

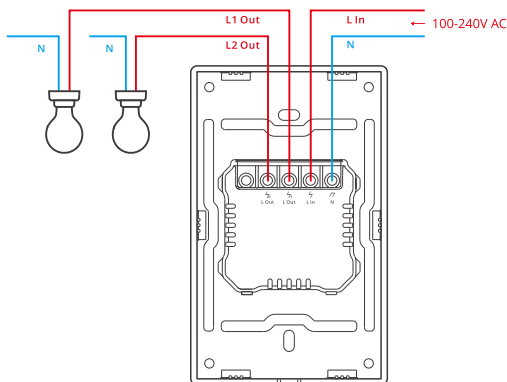

ⓘ 确保零火线接入无误。

3. 下载“易微联”App

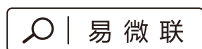

Android™ & iOS

4. 上电

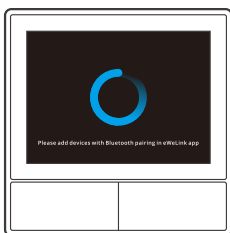

通电后，设备首次使用，默认进入蓝牙配网模式，屏幕状态如上图所示。

5. 添加设备



点击“+”，选择“蓝牙配网”，再根据 App 提示进行操作。

操作指引

下拉(屏幕亮度及休眠时间设置)

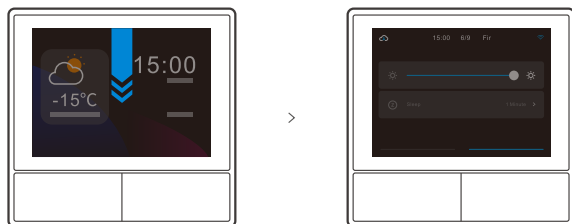

右滑(在 App 端添加温控器功能后,可在设备上对添加的温控器进行设置)

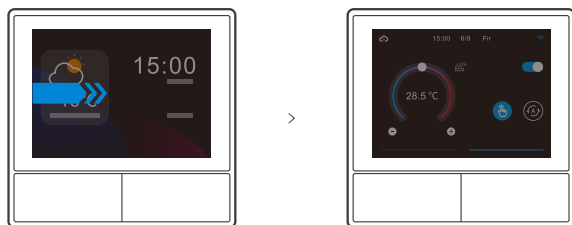

左滑(在 App 端添加组件后,可在设备上对添加的组件进行控制)

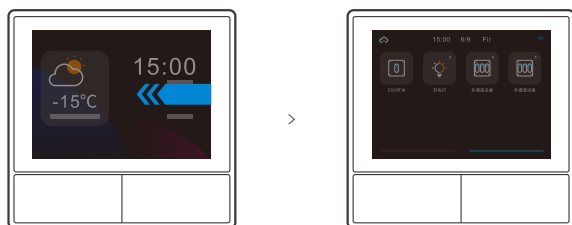

添加温控器

NSPanel 内置温度传感器监测室温,通过联动控制该易微联账户下的智能开关插座类设备(将普通的加热/制冷电器连接在智能设备上,改装成智能设备)的开关来使室温维持在设定的范围,从而实现温控。

进入 NSPanel 设备页面点击“温控器”选择温控器的执行设备,该页面显示的设备列表是该账户下支持绑定执行的所有设备(包含 NSPanel 自身的两个通道),执行设备只能选一个(多通道设备选择其中一个通道),选择设备的类型是加热/制冷。



设定好执行设备及其类型后,启用温控器功能,有两种温度控制模式:手动模式、自动模式

手动模式:

可以随时手动调整温度,温控器会一直按照设定的温度执行

自动模式:

可以添加最多6个不同的生效时间段。分别设置其温度。设置好之后会自动按照时间段执行,不能手动调温,除非切回手动模式。生效时间段结束后,绑定的执行设备会处于关闭状态。

⚠ 实际生效温度为 $\pm 1^{\circ}\text{C}$,比如设置 26°C ,则对应的温度范围为 $25-27^{\circ}\text{C}$ 。

添加屏幕组件

NSPanel 可以添加8个组件在屏幕上进行快捷控制。组件的类型可以是单个设备、同一类设备创建的群组 and 一键执行的智能场景。多通道及灯类设备有二级界面可以进行更详细的控制。



产品参数

产品型号	NSPanel-EU, NSPanel-US
输入	100-240V ~50/60Hz 4A/总负载
输出	100-240V ~ 50/60Hz 2A/通道 4A/总负载
LED负载	150W/110V/通道, 300W/110V/总负载 300W/220V/通道, 600W/220V/总负载
Wi-Fi	IEEE 802.11 b/g/n 2.4GHz
蓝牙标准	4.2 BLE
TFT 屏规格	3.5 英寸(电容屏)
TFT 屏分辨率	480x320像素
支持平台	Android & iOS
外壳材料	PC V0+冷轧钢+钢化玻璃
产品规格	NSPanel-EU: 86x86x41.7mm NSPanel-US: 120x74x41.7mm

重新配对 NSPanel

需要更换NSPanel的账户或连接的WiFi时,需重新配对添加。长按设备任意按键5秒直到显示屏提示设备已进入蓝牙配对状态,即可再次通过App蓝牙配对添加设备。

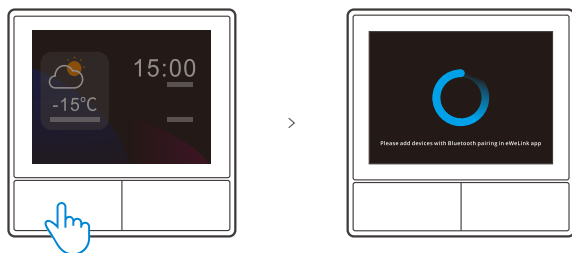

⚠ 三分钟内没进行配网,设备将退出蓝牙配网模式。

恢复出厂设置

在 eWeLink App 端“删除设备”，设备即恢复出厂设置。

常见问题

Wi-Fi设备与 eWeLink App 配对失败。

1. 确保设备处于配对模式。

三分钟内没进行配网，设备将自动退出配对模式。

2. 请开启定位服务并允许定位权限。

在选择 Wi-Fi 网络之前，请开启定位服务并允许定位权限。位置信息权限用于获取 Wi-Fi 列表信息。

如果单击禁用，您将无法添加设备。

3. 确保您的 Wi-Fi 网络为 2.4GHz 频段。

4. 确保您输入了正确的 Wi-Fi SSID 和密码，没有包含特殊字符。密码错误是配对失败的一个非常常见的原因。

5. 配对时设备应靠近路由器，以保证良好的传输信号条件。

Product Introduction

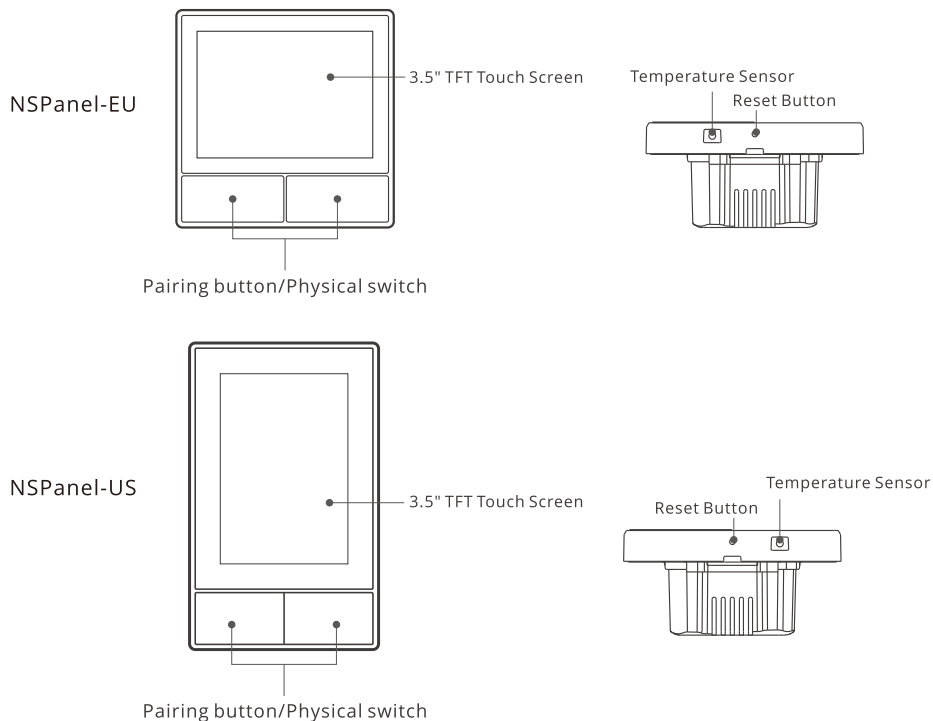

⚠ The device weight is less than 1 kg. The installation height of less than 2 m is recommended.

Features

NSPanel is a dual-channel smart touch control panel integrating three interactive methods, screen touching, voice control and App control. Users can control the device types including smart switch and plugs (heating/cooling) under the eWeLink account. Users are able to control multiple smart devices through adding widgets on their smart phones, such as turn on/off, schedule on/off the connected devices and share them with families to control.



Remote Control



Single/Countdown
Timing



Voice Control



Share Control



3.5" TFT Touch Screen



Adding Widgets



Smart Scene



Thermostat



Inching Mode



Interlock



Group Control



LAN Control

Operating Instruction

1. Power off

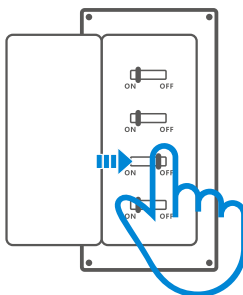

⚠ Please install and maintain the device by a professional electrician. To avoid electric shock hazard, do not operate any connection or contact the terminal connector while the device is powered on!

2. Wiring instruction

Light fixture wiring instruction:

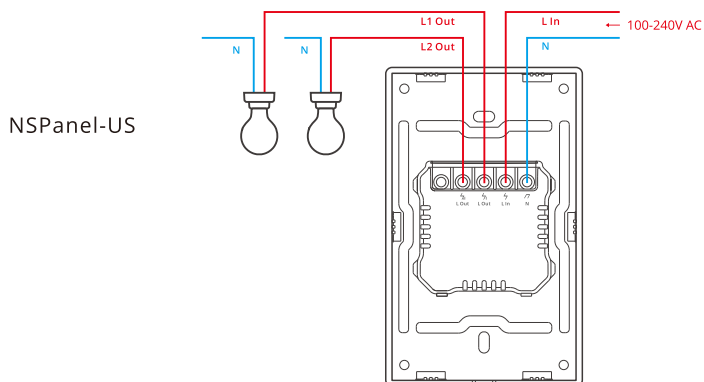
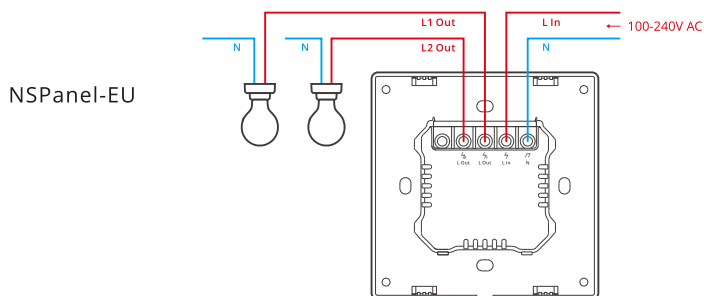

⚠ Make sure all wires are connected correctly.

3. Download the eWeLink App

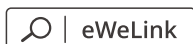

Android™ & iOS

4. Power on

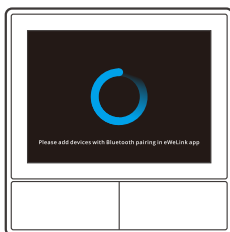

After powering on, the device will enter the bluetooth pairing mode during the first use. The screen status is shown in the above image.

5. Add the device

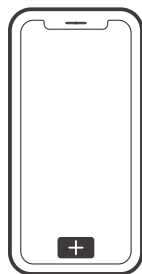

>

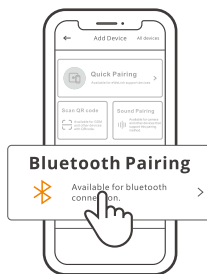

Tap “+” and select “bluetooth pairing”, then operate following the prompt on the App.

Operation Guide

Drop down

Settings of the screen brightness and sleep time

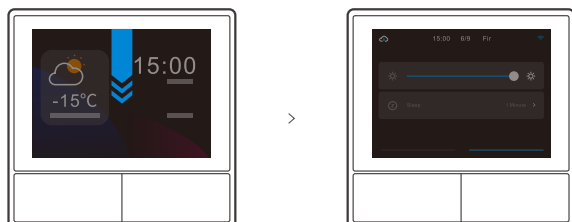

Swipe right

After adding temperature controller function in the App, you can set the added temperature controller on the device.

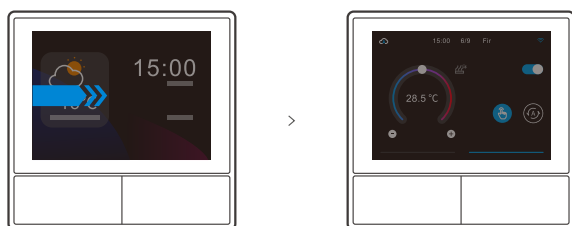

Swipe left

After adding widgets in the App, you can control the added widgets on the device.

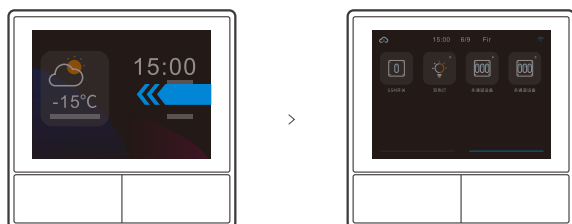

Bind Temperature Control Device

There is a built-in temperature sensor in the NSPanel to monitor the room temperature and you can maintain the room temperature by controlling the cooler/heater, which is connected with smart switches or smart plus and these devices are required to pair with eWeLink App.

Access the NSPanel interface in the App and tap “Thermostat” to select the devices in the Action device list. All the listed devices are supported to bind with the Thermostat (including two NSPanel channels). You can only select one device or one channel of the multi-channel device to execute and then choose heater or cooler as the Device type.

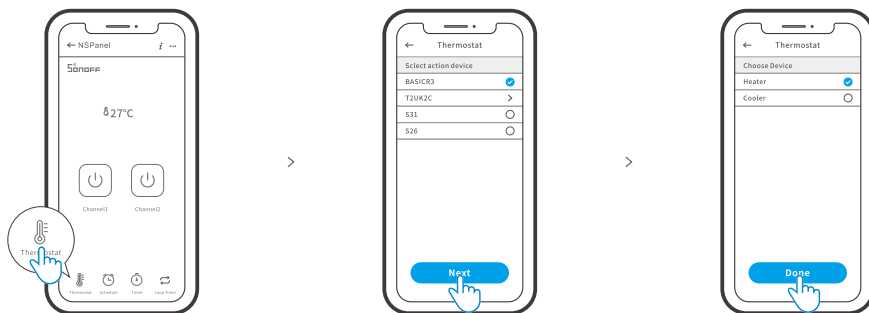

Active the Thermostat after selecting the Action device and Device type, then you can see there are two modes to control the temperature which are Manual mode and Auto mode.

Manual mode:

Allow you to adjust the temperature manually whenever you want and then the Thermostat will execute to maintain the manual setting temperature.

Auto mode:

Allow you to set 6 target temperature at most by tapping “Add” to set the temperature respectively. Once set, all setting will execute automatically at certain time duration and cannot be controlled manually unless switched to the Manual mode. The binding devices will turn off when they are out of schedule.

⚠ Actual room temperature will be $\pm 1^{\circ}\text{C}$. For example, the setting temperature is 26°C but the actual temperature range is between 25°C and 27°C .

Add Widgets

NSPanel can be added 8 widgets in the screen for Quick Control. The form of widget can be single device, group devices of the congeneric devices and Tap to Perform Scene. In addition, you can control more features of the multi-gang and lighting devices in the secondary interface.

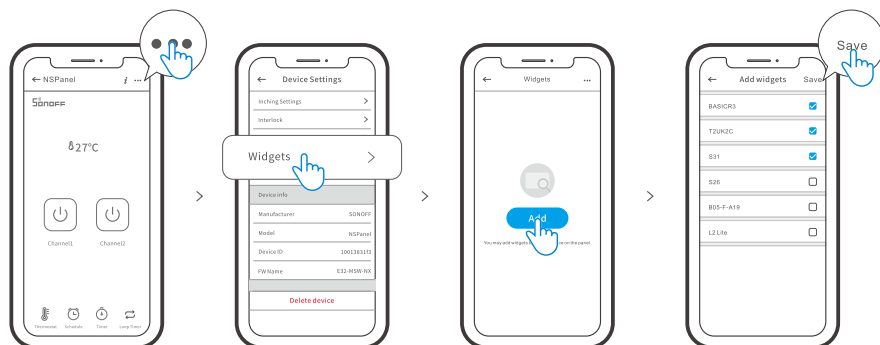

Specifications

Model	NSPanel-EU, NSPanel-US
Input	100-240V ~ 50/60Hz 4A Max
Output	100-240V ~ 50/60Hz 2A/Gang 4A/Total
LED load	150W/110V/Gang, 300W/110V/Total 300W/220V/Gang, 600W/220V/Total
Wi-Fi	IEEE 802.11 b/g/n 2.4GHz
Bluetooth Standard	4.2 BLE
Screen Size	3.5" (Capacitive Touch Panel)
Screen Resolution	480*320px
Operating systems	Android & iOS
Shell materials	PC V0+CRS+Toughened Glass
Dimension	NSPanel-EU: 86x86x41.7mm NSPanel-US: 120x74x41.7mm

Re-establish Pairing of the NSPanel

When you want to change the NSPanel's account or connected WIFI, it requires you to pair the NSPanel again. Press any bottom of the device for 5s until the screen indicates that it had entered into Bluetooth pairing mode and then release. Now the NSPanel is available for Bluetooth pairing in the eWeLink App.

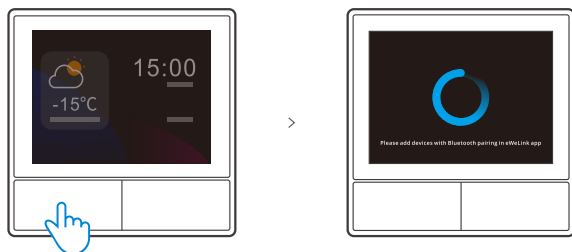

⚠ The device will exit the bluetooth pairing mode if not paired within 3mins.

Factory Reset

Deleting the device on the eWeLink app indicates you restore it to factory setting.

Common Problems

Fail to pair Wi-Fi devices to eWeLink App

1. Make sure the device is in pairing mode. After three minutes of unsuccessful pairing, the device will automatically exit pairing mode.
2. Please turn on location services and allow location permission. Before choosing the Wi-Fi network, location services should be turned on and location permission should be allowed. Location information permission is used to obtain Wi-Fi list information. If you click Disable, you will not be able to add devices.
3. Make sure your Wi-Fi network runs on the 2.4GHz band.
4. Make sure you entered a correct Wi-Fi SSID and password, no special characters contained. Wrong password is a very common reason for pairing failure.
5. The device shall get close to the router for a good transmission signal condition while pairing.

FCC Warning

Changes or modifications not expressly approved by the party responsible for compliance could avoid the user's authority to operate the equipment.

This device complies with part 15 of the FCC Rules. Operation is subject to the following two conditions: (1) This device may not cause harmful interference, and (2) this device must accept any interference received, including interference that may cause undesired operation.

FCC Radiation Exposure Statement:

This equipment complies with FCC radiation exposure limits set forth for an uncontrolled environment. This equipment should be installed and operated with minimum distance 20cm between the radiator & your body. This transmitter must not be co-located or operating in conjunction with any other antenna or transmitter.

Note:

This equipment has been tested and found to comply with the limits for a Class B digital device, pursuant to part 15 of the FCC Rules. These limits are designed to provide reasonable protection against harmful interference in a residential installation. This equipment generates, uses and can radiate radio frequency energy and, if not installed and used in accordance with the instructions, may cause harmful interference to radio communications. However, there is no guarantee that interference will not occur in a particular installation. If this equipment does cause harmful interference to radio or television reception, which can be determined by turning the equipment off and on, the user is encouraged to try to correct the interference by one or more of the following measures:

- Reorient or relocate the receiving antenna.
- Increase the separation between the equipment and receiver.
- Connect the equipment into an outlet on a circuit different from that to which the receiver is connected.
- Consult the dealer or an experienced radio/TV technician for help.

Hereby, Shenzhen Sonoff Technologies Co., Ltd. declares that the radio equipment type NSPanel-EU, NSPanel-US is in compliance with Directive 2014/53/EU. The full text of the EU declaration of conformity is available at the following internet address:

<https://sonoff.tech/usermanuals>



Shenzhen Sonoff Technologies Co., Ltd.

1001, BLDG8, Lianhua Industrial Park, shenzhen, GD, China
ZIP code: 518000 Website: sonoff.tech

