

SSM-SERIES

Stainless Steel Media Filtration System



WATER FILTRATION SYSTEMS AND EQUIPMENT

WWW.EVERFILT.COM





SSM-Stainless Steel Media Filter

Everfilt's SSM-Series Media Filter's are constructed using heavy 11 gauge, 304 stainless steel. Unlike some other filters, users will never see an Everfilt tank flex during start-up or backwash because thin gauge stainless steel has been used in the filter's construction. This ensures long lasting, trouble-free operation. Filter operation will be effective even at higher PSI's or pressure differentials.

All-Steel, All-Welded Underdrain

Everfilt pioneered the design of the radial hub - stainless steel underdrain — and many manufacturers have since followed our lead. Everfilt's underdrain is hydraulically balanced to ensure efficient collection of filtered water. The lateral collection screens are matched to the natural flow of water through the filter. It also means that during backwash, the filter bed is lifted uniformly and fully, thus achieving complete cleaning and regeneration of the media.

The high strength profile wire screen retains medias finer than No. 20 silica sand, thus eliminating the need for filter back-up screens. The non-clogging characteristic of the screen makes it the most reliable collection system available. Everfilt's underdrain is all stainless steel and fully welded. The added strength results in years of trouble-free, reliable operation.

Heavy-Duty Backwash Valve

Everfilt's backwash valve body is made of high strength ductile iron and is coated with industrial grade epoxy — a material known for its resistance to corrosion. All wetted surfaces are stainless steel or epoxy coated. The hydraulic design prevents valve slamming and eliminates possible damage to the valve and manifolding. Backwash valves can be ordered for manual, semi-automatic or automatic operation.



SSM - SERIES



Backwash Valve



Tank Fill Port

Deflector





Automatic Backwash Control

Everfilt designs and manufactures its own automatic backwash controls. User friendly control knobs, panel labeling and display lights make for easy use. Made of solid-state electronic circuits, the automatic controls help assure effective system operation by initiating needed backwash in an efficient manner. The control can be set to trigger backwash when a specified pressure differential or time interval is reached. The control is housed in a water resistant enclosure.

An optional LCD readout indicates when the next backwash cycle is timed to begin, the total number of backwash cycles that have been initiated since last reset, and the number of backwashes that have been triggered by pressure differential. Users find this information very useful in identifying operating conditions requiring their attention. Models are available for 4, 8 and 12 station controls. In some cases it's possible to expand an existing filter installation without the expense of changing controls.

Backwash Operation

The backwash valve is opened by hand or by automatic valve. This shuts off the incoming raw water and opens backwash port to a near atmospheric condition. Pressurized filter water from adjacent filter(s) is forced through the stainless steel underdrain, upward through the gravel pack, expanding the sand bed, forcing the lighter particulate matter out the backwash line. Reversing the backwash valve returns the unit to the filter operation. Everfilt's unique underdrain uniformly spreads the incoming filtered water so that the maximum debris is separated from the sand in the shortest time.

Automatic Valve Actuation

Valve Actuation is accomplished by using the hydraulic power of the water source to move or actuate the backwash valve in and out. The electrical signal from the electronic control energize a solenoid valve, which allows the hydraulic pressure of the water source to push against a piston compressing a spring, opening the backwash valve. De-energizing the solenoid valve allows the hydraulic pressure to bleed off of the piston, allowing the spring to expand, retracting the piston, closing the valve.

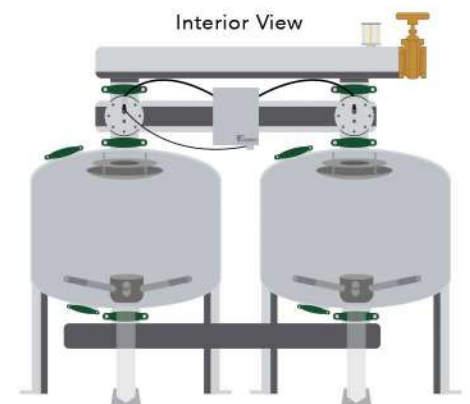
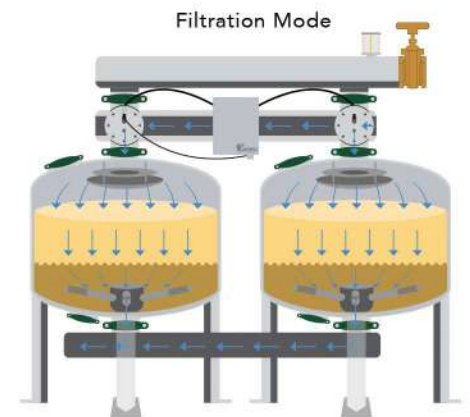
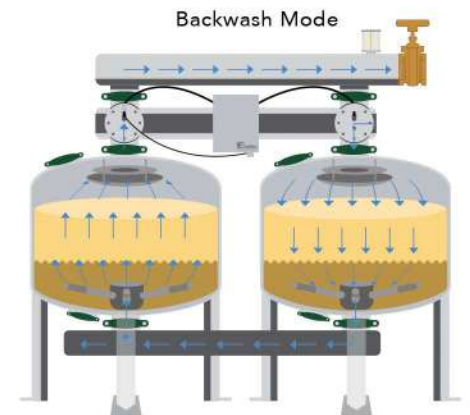

Control Construction

Solid-state computerized control, housed in a water resistant enclosure. No moving parts to wear out or malfunction.

Controls

SEQUENCE LAMP	The lamp lights during the sequencing operation.
168 HOUR TIMER	Min. 1/8 hour. Starts sequencing operation at pre-selected time.
TEST	For testing control operation and output stations.
2 SEC. to 330 MIN. FLUSH TIME	Controls backwash time per filter.
0 SEC. to 90 MIN. DWELL TIME	Controls time between backwash of each filter.
POWER SWITCH	Disconnects power to control.
MANUAL START	Initiates new cycle whenever it is pressed.
P.D. POWER SWITCH	Disconnects pressure differential sensor from control.
CIRCUIT BREAKER	Overload protection for control.
PROGRAMMABLE P.D. DELAY	0 to 360 sec.



Specifications

Voltage Input — 120 VAC/12 VDC

Voltage Output — 12 VDC

Loading:

Dormant Operation — 25 MA

Sequencing Operation — 300 MA

Station Capacity — 2.0 Amps

Number of Station* — One at 1.0 Amp
(this station is active through entire sequence operation)



Options

220-440 VAC

12 VDC Solar Panel

4 Station Control w/o LCD read Out (St'd)

4, 8, or 12 Station Control with LCD Read Out Contact Factory for Details



Protect productivity and profits with an Everfilt® filtration system.

Everfilt offers complete systems, and individual components to meet your demands. Providing solutions that deliver cost-effective alternatives, along with custom replacement options!

Specifications - Other Sizes & Working Pressures Available - Consult Factory

Providing solutions is our goal and with that, we understand that not all projects are the same. Custom flow rates, specific connection points, high pressure applications and even areas where corrosive or harmful water may be present, are all factors to consider when purchasing your filtration system. Our team of engineers and product specialists can assist in selecting equipment that not only will provide a maximum life expectancy, but a system that will provide results for years to come. *Made in the USA* allows Everfilt the ability to provide a level of quality control and customer service that continues to raise industry standards.

Contact a Dealer or Sales Representative to Learn More!

SSM-SERIES STAINLESS STEEL

NOT ALL TANKS ARE CREATED EQUAL!

Everfilt

Competitors



MODEL	System Line Size	Flow Range GPM	Filtration Area (ft ²)	Max Working Pressure (PSI)	Shipping WT.	Gravel ***LBS	Media ***LBS	GPM Backwash #20 or #11
SSM12-2	1 1/2"	32-40	1.6	125	80	30	90	12.0 †
SSM18-2	3"	70-90	3.5	125	180	150	400	27.0
SSM24-2	4"	125-160	6.2	100	250	300	800	47.0
SSM30-2	4"	195-245	9.8	100	340	600	1000	74.0
SSM36-2	6"	280-350	14.2	100	600	800	1600	107.0
SSM48-2	6"	500-625	25.0	100	960	1000	2600	188.0
SSM48-3	6"	750-940	37.5	100	1490	1500	3900	188.0
SSM48-4	8"	1000-1250	50.0	100	2050	2000	5200	188.0
SSM48-5	10"	1250-1565	62.5	100	2550	2500	6500	188.0
SSM48-6	10"	1500-1875	75.0	100	3030	3000	7800	188.0
SSM48-7	12"	1750-2190	88.8	100	3550	3500	9100	188.0
SSM48-8	12"	2000-2500	88.8	100	3850	4000	10400	188.0
SSM48-9	12"	2250-2815	88.8	100	4360	4500	11700	188.0
SSM48-10	12"	2500-3125	88.8	100	4870	5000	13000	188.0
SSM48-11	14"	2750-3435	88.8	100	5370	5500	14300	188.0
SSM48-12	14"	3000-3750	88.8	100	5880	6000	15600	188.0

*Total Area **Higher Pressure Ratings Available - Consult Factory ***Media & Gravel Sold Separately
+See separate product literature for specifications



48" Underdrain

SSM-Series Stainless Steel Filter IN-LINE

Everfilt offers many configurations to accommodate space, flow rates and existing connection points that may already be installed on site. This is done in an effort to provide systems and equipment that require the least amount of effort to get your filtration system up and running as quickly and effortlessly as possible.

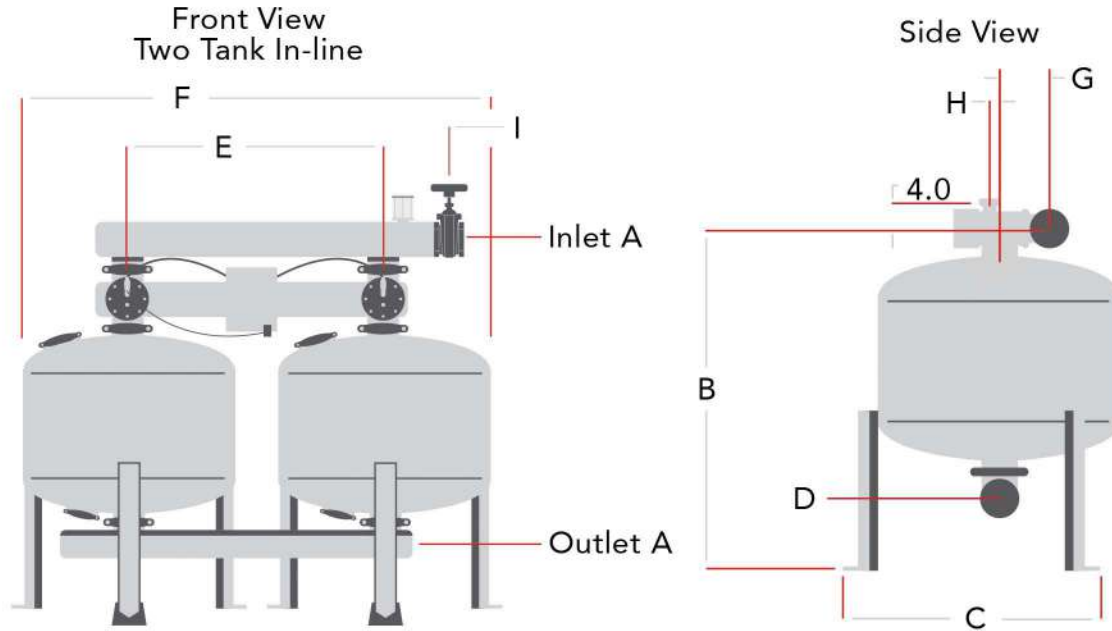

MODEL	A	B	C	D	E	F	G	H
SSM18-2	3	45	20	9.8	22	40	7	3.1
SSM18-3	3	45	20	9.8	22	62	7	3.1
SSM24-2	4	48	24	9.2	28	52	7.5	3.1
SSM24-3	4	48	24	9.2	28	80	7.5	3.1
SSM30-2	4	49.5	28	9.2	34	64	7.5	3.1
SSM30-3	4	49.5	28	9.2	34	98	7.5	3.1
SSM36-2	6	52.4	35	10.2	38.7	74.7	9.3	4.1
SSM36-3	6	52.4	35	10.2	38.7	113.5	9.3	4.1
SSM48-2	6	59	44	10.2	54	102	9.3	4.1
SSM48-3	6	59	44	10.2	54	156	9.3	4.1
SSM48-4	8*	59	44	9.2	54	210	10.3	4.1
SSM48-4	10*	59	44	8.2	54	210	10.3	4.1
SSM48-5	8*	59	44	9.2	54	264	10.3	4.1
SSM48-5	10*	59	44	8.2	54	264	10.3	4.1
SSM48-6	8*	59	44	9.2	54	318	10.3	4.1
SSM48-6	10*	59	44	8.2	54	318	11.4	4.1
SSM48-7	12	59	44	7.2	54	372	12.4	4.1
SSM48-8	12	59	44	7.2	54	426	12.4	4.1
SSM48-9	12	59	44	7.2	54	480	12.4	4.1
SSM48-10	12	59	44	7.2	54	534	12.4	4.1

Options

All filtration systems are not created equal and Everfilt understands that! That is why we offer multiple fabrication options to accommodate your needs.

- Flanged Connections
- Specific Manifold Pipe Size

* High pressure options, skid mounted options and custom system designs are available. Please see coordinating literature or contact a sales representative for more info.



SSM-Series Stainless Steel Filter *CENTER FEED*

Everfilt offers many configurations to accommodate space, flow rates and existing connection points that may already be installed on site. This is done in an effort to provide systems and equipment that require the least amount of effort to get your filtration system up and running as quickly and effortlessly as possible.

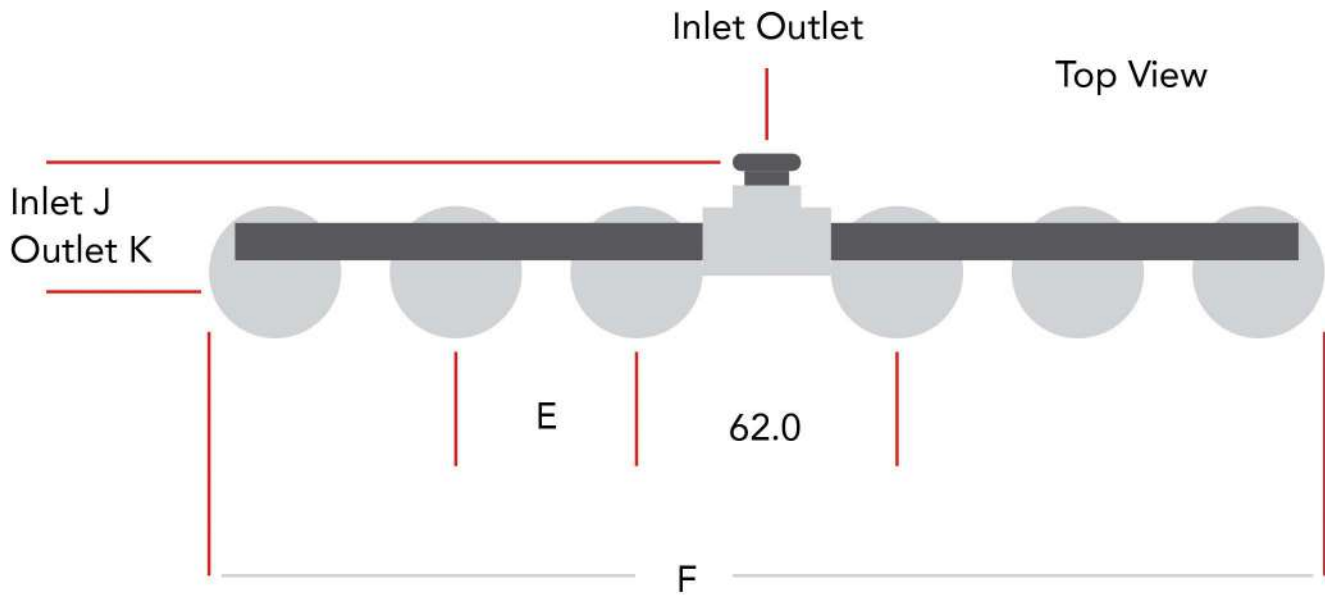

MODEL	A	B	C	D	E	F	J	K
SSM48-4	8	58.8	53.0	10.2	54.0	218.0	23.3	14.0
SSM48-5	10	58.8	53.0	10.2	54.0	272.0	23.3	14.0
SSM48-6	10	58.8	53.0	10.2	54.0	326.0	23.3	14.0
SSM48-7	10	58.8	53.0	9.2	54.0	380.0	26.4	16.0
SSM48-8	12	58.8	53.0	9.2	54.0	434.0	26.4	16.0

Options

All filtration systems are not created equal and Everfilt understands that! That is why we offer multiple fabrication options to accommodate your needs.

- Flanged Connections
- Specific Manifold Pipe Size

* High pressure options, skid mounted options and custom system designs are available. Please see coordinating literature or contact a sales representative for more info.



Protect productivity and profits with an Everfilt® filtration system.

Everfilt offers complete systems, and individual components to meet your demands. Providing solutions that deliver cost-effective alternatives, along with custom replacement options!



SSM-Series Stainless Steel Filter H-PATTERN

Everfilt offers many configurations to accommodate space, flow rates and existing connection points that may already be installed on site. This is done in an effort to provide systems and equipment that require the the least amount of effort to get your filtration system up and running as quickly and effortlessly as possible.

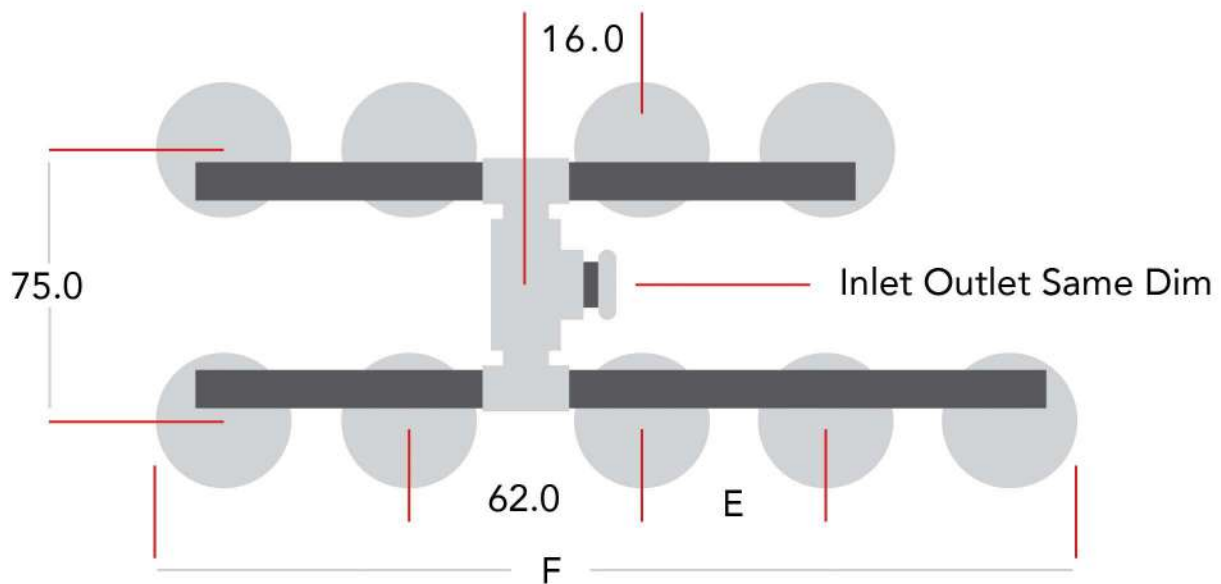

MODEL	A	B	C	D	E	F
SSM48-9	14	58.8	53.0	10.2	54.0	272.0
SSM48-10	14	58.8	53.0	10.2	54.0	272.0
SSM48-11	14	58.8	53.0	10.2	54.0	326.0
SSM48-12	14	58.8	53.0	10.2	54.0	326.0

Options

All filtration systems are not created equal and Everfilt understands that! That is why we offer multiple fabrication options to accommodate your needs.

- Flanged Connections
- Specific Manifold Pipe Size

* High pressure options, skid mounted options and custom system designs are available. Please see coordinating literature or contact a sales representative for more info.



Protect productivity and profits with an Everfilt® filtration system.

Everfilt offers complete systems, and individual components to meet your demands. Providing solutions that deliver cost-effective alternatives, along with custom replacement options!



SSM-Series Stainless Steel Filter CLUSTER

Everfilt offers many configurations to accommodate space, flow rates and existing connection points that may already be installed on site. This is done in an effort to provide systems and equipment that require the least amount of effort to get your filtration system up and running as quickly and effortlessly as possible.

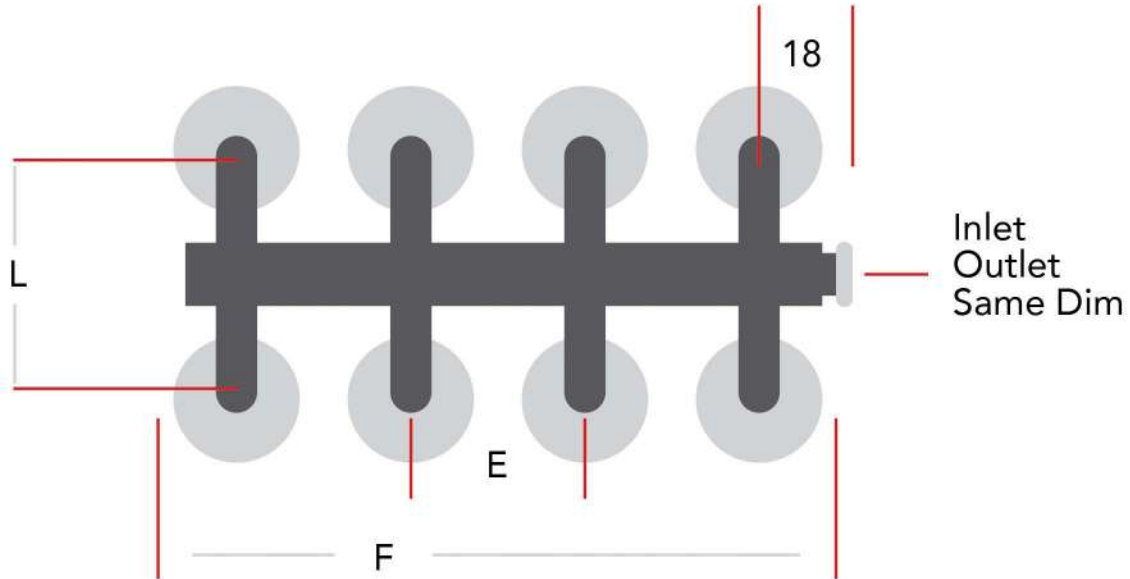

MODEL	A	B	C	D	E	F	L
SSM48-6	10	58.8	53.0	11.2	54.0	156.0	60.0
SSM48-7	10	58.8	53.0	11.2	54.0	210.0	60.0
SSM48-8	12	58.8	53.0	11.2	54.0	210.0	62.0
SSM48-9	14	58.8	53.0	11.2	54.0	264.0	63.2
SSM48-10	14	58.8	53.0	11.2	54.0	264.0	63.2
SSM48-11	14	58.8	53.0	11.2	54.0	318.0	63.2
SSM48-12	14	58.8	53.0	11.2	54.0	318.0	63.2

Options

All filtration systems are not created equal and Everfilt understands that! That is why we offer multiple fabrication options to accommodate your needs.

- Flanged Connections
- Specific Manifold Pipe Size

* High pressure options, skid mounted options and custom system designs are available. Please see coordinating literature or contact a sales representative for more info.



Protect productivity and profits with an Everfilt® filtration system.

Everfilt offers complete systems, and individual components to meet your demands. Providing solutions that deliver cost-effective alternatives, along with custom replacement options!



SSM-Series Stainless Steel Filter SSM-000

As the demand for water filtration systems increase the applications become more diverse. Everfilt has created a variety of individual tank options to accommodate those projects that require additional features. **Everfilt's SSM-000** series continues to be the standard in quality filtration equipment.

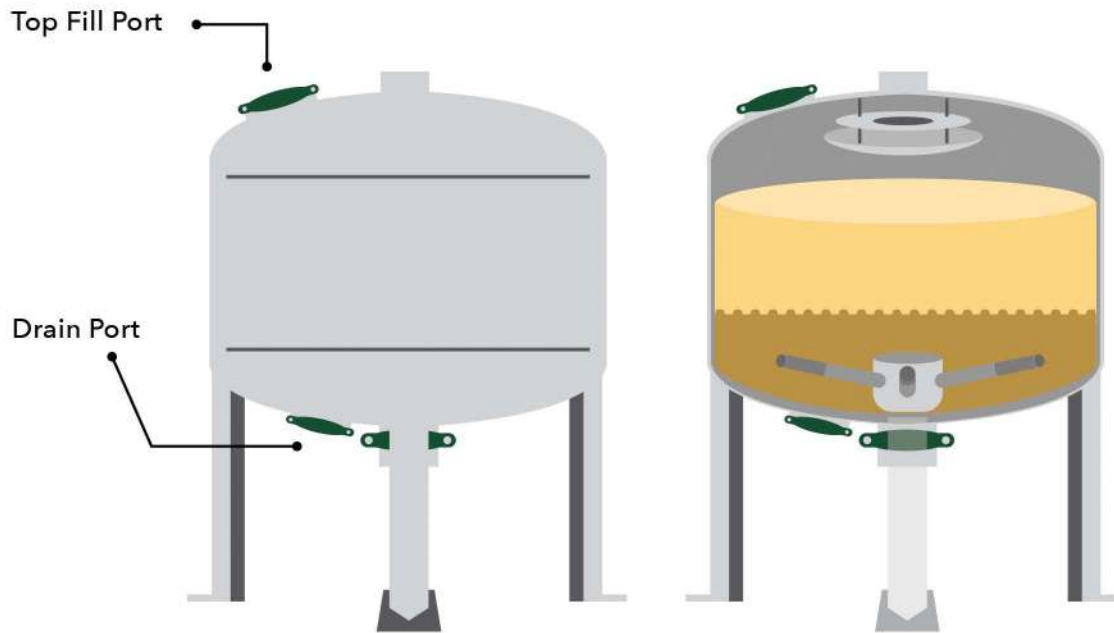

MODEL SSM-000 FEATURES

UNDERDRAIN -

WELDED STAINLESS STEEL WEDGEWIRE UNDERDRAIN.

INTERIOR COATING -

NONE

EXTERIOR COATING -

NONE

SSM-000-48-8A-H

MATERIAL MODEL TANK DIAMETER NUMBER OF TANKS AUTOMATIC CONFIGURATION

Protect productivity and profits
with an Everfilt® filtration system.

TANK SIZE	DRAIN PORT	FILL PORT
18"	* 3"	* 4"
24"	* 3"	* 5"
30"	* 3"	* 5"
36"	* 4"	* 8"
48"	* 4"	* 8"
54"	* 4"	* 8"

*= one per tank **= two per tank



SSM-Series Stainless Steel Filter SSM-001

As the demand for water filtration systems increase the applications become more diverse. Everfilt has created a variety of individual tank options to accommodate those projects that require additional features. **Everfilt's SSM-001** series continues to be the standard in quality filtration equipment.

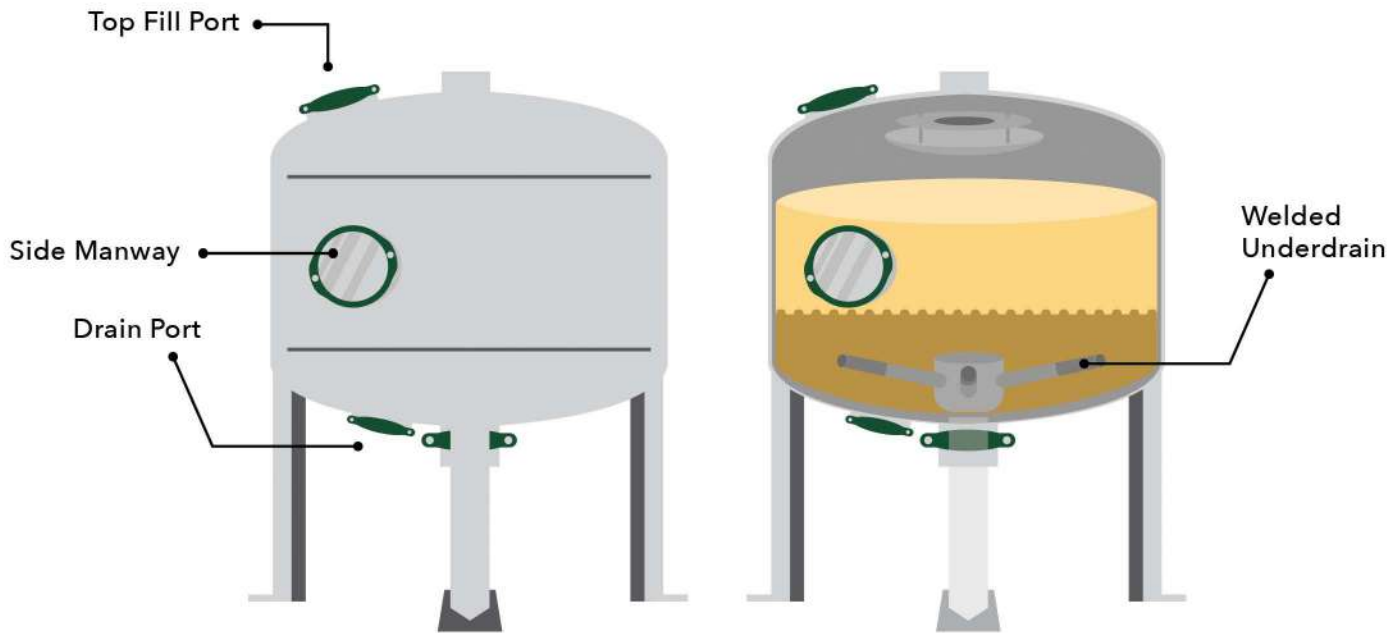

MODEL SSM-001 FEATURES

UNDERDRAIN -

WELDED STAINLESS STEEL WEDGEWIRE UNDERDRAIN.

INTERIOR COATING -

NONE

EXTERIOR COATING -

NONE

SSM-001-48-8A-H

MATERIAL MODEL TANK DIAMETER NUMBER OF TANKS AUTOMATIC CONFIGURATION

Protect productivity and profits
with an Everfilt® filtration system.

TANK SIZE	DRAIN PORT	FILL PORT
18"	* 3"	* 4"
24"	* 3"	* 5"
30"	* 3"	* 5"
36"	* 4"	* 8"
48"	* 4"	* 8"
54"	* 4"	* 8"

*=one per tank **= two per tank



SSM-Series Stainless Steel Filter SSM-002

As the demand for water filtration systems increase the applications become more diverse. Everfilt has created a variety of individual tank options to accommodate those projects that require additional features. **Everfilt's SSM-002** series continues to be the standard in quality filtration equipment.

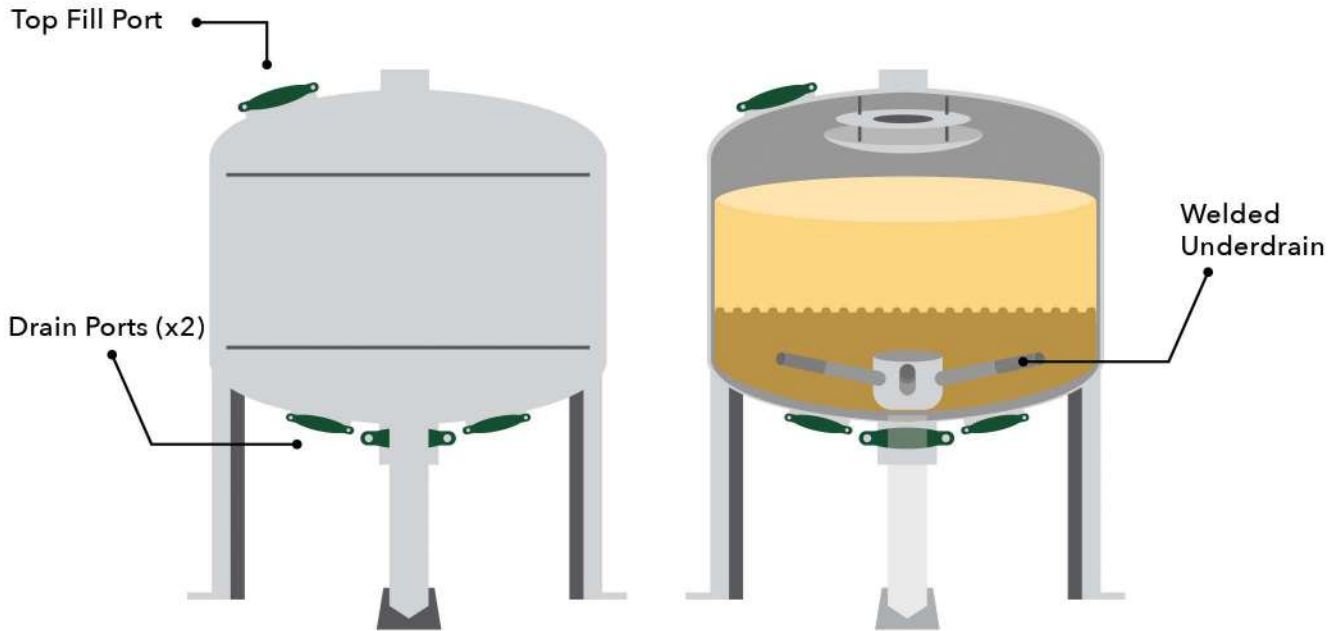

MODEL SSM-002 FEATURES

UNDERDRAIN -

WELDED STAINLESS STEEL WEDGEWIRE UNDERDRAIN.

INTERIOR COATING -

NONE

EXTERIOR COATING -

NONE

SSM-002-48-8A-H

MATERIAL MODEL TANK DIAMETER NUMBER OF TANKS AUTOMATIC CONFIGURATION

Protect productivity and profits
with an Everfilt® filtration system.

TANK SIZE	DRAIN PORT	FILL PORT
18"	* 3"	* 4"
24"	* 3"	* 5"
30"	* 3"	* 5"
36"	* 4"	* 8"
48"	* 4"	* 8"
54"	* 4"	* 8"

*=one per tank **= two per tank

