



PETLIBRO.COM

## PETLIBRO

CAPSULE Dog Fountain

---

**Model:** PLWF008

**©PETLIBRO All Rights Reserved**

**Manufacturer:** Shenzhen Libro Technology Co., Ltd.

**Address:** 12/F, Tower B, GALAXY WORLD, Yabao Road,  
Longgang District, Shenzhen, China

**Made in China**

---

PLWF008-V0001



**RoHS**

CAN ICES-003 (B)/NMB-003(B)

This device complies with Part 15 of the FCC Rules. Operation is subject to the following two conditions: (1) this device may not cause harmful interference, and (2) this device must accept any interference received, including interference that may cause undesired operation.

# PETLIBRO®

## USER MANUAL

CAPSULE Dog Fountain

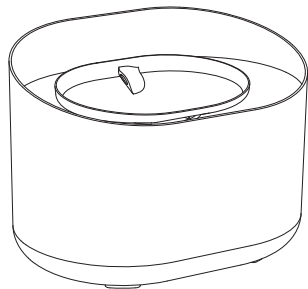

\*Before using the product, please read this manual thoroughly and retain it for future reference.

## LEGAL DISCLAIMER NOTICE

This legal disclaimer applies to purchasers and users of products manufactured by or on behalf of Shenzhen Libro Technology Co., Ltd. and its affiliates (collectively, "Petlibro" ).

Unless otherwise expressly indicated in writing, Petlibro' s products and instructions relating thereto are subject to change without notice. Users should check for and obtain the latest relevant information and verify that such information is current and complete before placing orders for Petlibro products.

Unless Petlibro has explicitly designated an individual Petlibro product as meeting the requirements of a particular industry standard or a particular qualification, Petlibro is not responsible for any failure of an individual Petlibro product to meet the requirements of such industry standard or particular qualification.

The purchasers and users of Petlibro product are recommended to check the product label or USER MANUAL prior to using any of our products. If there are any discrepancies customers should follow the information provided in the product or packaging. You should contact the manufacturer directly for any clarification relating to the product and recommended use. Unless expressly and specifically approved in writing by Petlibro on a case- by- case basis, use of any Petlibro products in unauthorized applications might not be safe and thus is at the user' s sole risk.

To the maximum extent permitted by applicable law, Petlibro disclaims (i) any and all liability for special, punitive, consequential, incidental or indirect damages or lost revenues or lost profits, and (ii) any and all implied warranties, including implied warranties of fitness for particular purpose, non-infringement and merchantability.

# Contents

/ English

Safety Precautions	01
How To Use	03
Care Instructions	08
Troubleshooting	10
Specifications	11
Warranty	12
SAFETY PRECAUTIONS	12

# PRODUCT OVERVIEW

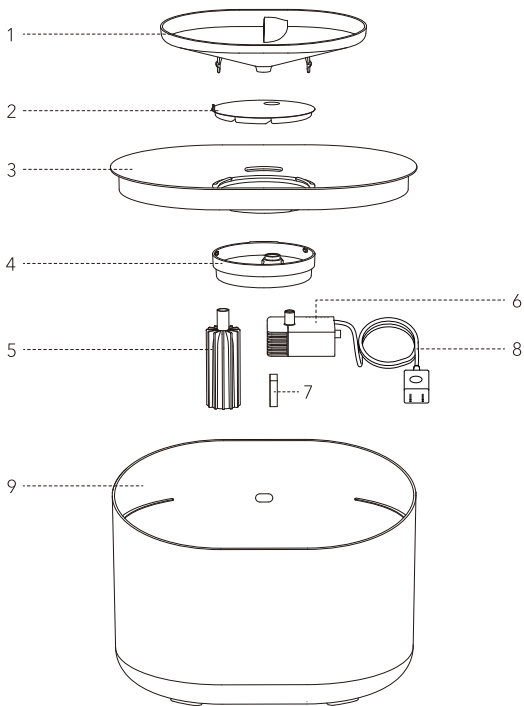

1. Serving Tray
2. Filter
3. Serving Tray Base
4. Filter Tray
5. Silicone Water Pipe
6. Water Pump
7. Foam Filter
8. Power Adapter
9. Water tank

## Getting Started



Scan the QR code above to watch the video for product installation and cleaning.

### Notes:

- Replace the filter every two weeks.
- Clean the water tank at least once every seven days.

# HOW TO USE

1. Soak the filter in a clean bowl for 5 minutes, then rinse the filter thoroughly with tap water.

## Notes:

1) The filter must be fully soaked before the fountain is turned on; otherwise, the water may not flow through the filter smoothly and cause spillage.

2) Do not soak the filter in the water tank of the fountain in case of any surface dust.

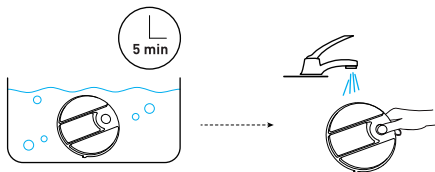

2. Insert the foam filter into the groove of the water pump. Position the pump according to the bottom slot shape.

## Note:

Please pay attention to aligning the recessed part of the pump with the protruding part of the water tank, otherwise the pump cannot be installed firmly

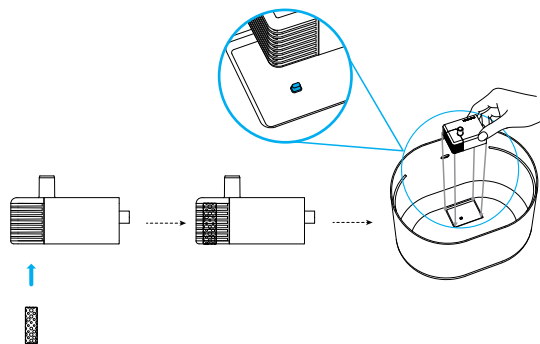

3. Insert the water pump's USB cable through the hole at the back of the water tank, starting from the inside and extending outward.

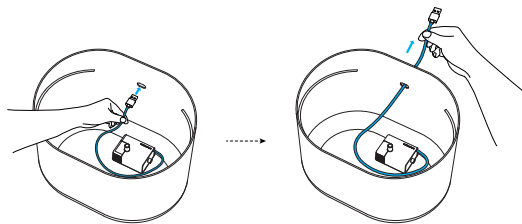

4. Clip the wire into the anti-pull slot.

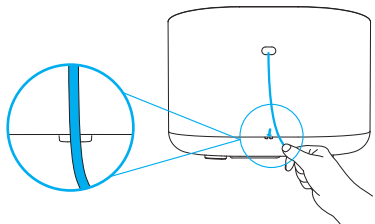

5. Plug the USB into the power adapter.

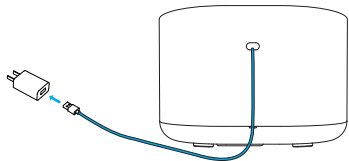

6. Install the silicone pipe on the pump. Add water to the tank. (The pump will operate automatically when it is placed in the water)

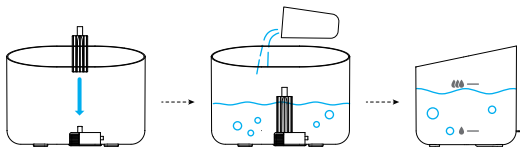

7. Fit the filter tray onto the bottom of the drainage tray.

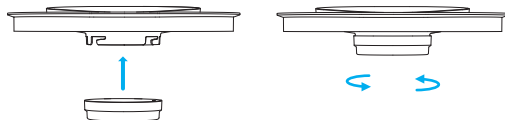

**Note:**

**When installing, ensure to rotate the filter tray until it aligns with the serving tray base.**

8. Place the soaked filter into the filter tray.

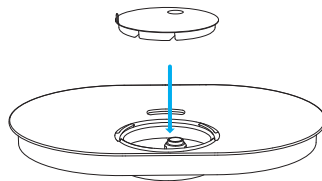

9. Install the serving tray onto the serving tray base.

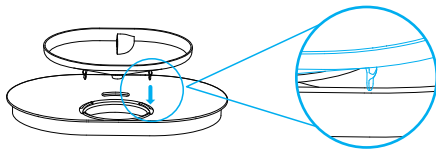

**Note:**

The serving tray features a water outlet that should be positioned closer to the rear of the product. Ensure the parts snap into place securely during installation to guarantee smooth water flow.

10. Install the serving tray, serving tray base, filter, and filter tray into the water tank.

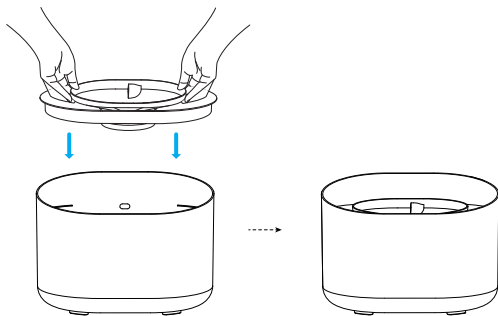

**Note:**

Press down until the indicator line on the water tank's rear inner wall is aligned.

11. Connect the power adapter. (The water fountain initiates its 'self-cleaning mode' every six hours, intermittently flushing the serving tray with water.)

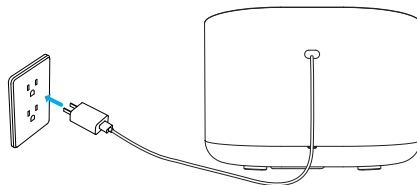

## **CARE INSTRUCTIONS**

---

1. Replace the filter and the foam filter at least once every 2 weeks.
2. Clean the pump and fountain at least once every weeks.

### **How to clean the pump**

1. Remove the foam filter, pump cover and impeller cover in sequence.

**Note:**

The foam filter affects the water yield very much, so please clean it frequently and replace it in time when cleaning the pump.

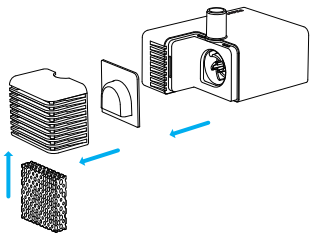

2. Remove the impeller by hand.

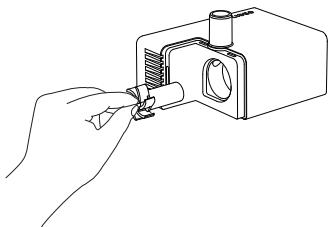

3. Use the brush to clean the parts with water.

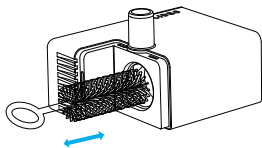

**Tip: The brush can also be used to clean the spout. Recommended to clean the spout every 2 weeks.**

## TROUBLESHOOTING

Problem	Solution
Water keeps spilling out of the water tray.	The filter may not be fully soaked. Please soak the filter in a clean bowl (not in the water tank) for 5 minutes before the first use.
The pump stops working.	<ol style="list-style-type: none"> <li>1) Fill in water between MIN and MAX. The pump will fail if it runs dry.</li> <li>2) Clean the pump, water tank, and drinking basin.</li> <li>3) If the above solutions don't work, please contact us at <a href="mailto:support@petli-bro.com">support@petli-bro.com</a></li> </ol>
How often should I change the filters? Where to get them?	Please replace the filter at least once every 2 weeks. Please visit <a href="http://www.petli-bro.com">www.petli-bro.com</a> to purchase new filters.
Why do I need to soak the filter before first use?	The filters absorb more water (and therefore clean more water) when they're wet and expanded. Soaking the filter removes particulate matter that may have settled on the filter.
Water output speed slows down.	<ol style="list-style-type: none"> <li>1) For the first use (or reuse after long-time storage), the water pump needs to discharge air, it's normal if the water output speed slows down.</li> <li>2) It is dirt in the pump, please refer to "How to Clean the Pump" in the manual to clean it.</li> </ol>
No water after installation	Please ensure that the power supply is connected, the water pump and base are installed correctly. Please refer to the "How to Use" section of the manual.



Problem	Solution
Black residues and dirt appear in the water tank and on the filter element	1) Please ensure that clean water sources are replaced regularly. 2) Please make sure to soak and wash the filter element in advance.

## SPECIFICATIONS

Model	PLWF008
Power Adapter	Input: 100-240V 50/60Hz Output: 5V/1A
Material	ABS
Water Tank Capacity	2.1 Gal (8L)
Dimensions	338x253x245 mm / 13.3x9.9x9.6 inch
Net Weight	1580g / 55.7oz

## WARRANTY

- 24-month warranty
- For guidance on product use, please contact our customer service team via email: [support@petlibro.com](mailto:support@petlibro.com).

## SAFETY PRECAUTIONS

### !WARNING

- Dispose of **all** packaging materials properly. Keep the polybags away from children and pets as these bags could cause suffocation.
- Do **NOT** allow children to play with, in or around the pet water fountain.
- To avoid injury, please keep close supervision when the appliance is used near children.
- Do **NOT** use the water fountain with pets not able to reach the water tray or with any physical disability.
- Do **NOT** place any foreign object in the water tank.
- Do **NOT** disassemble the pet fountain other than components as instructed in this User Manual.
- Do **NOT** use the pet fountain for anything other than its intended use.
- **Only** use attachments recommended or sold by the manufacturer. The use of attachments not recommended or sold by the manufacturer may cause an unsafe condition.
- Do **NOT** modify the pet fountain.

- Do NOT operate any appliance if the unit is malfunctioning or has been damaged.
- Do not attempt repair on the device yourself. Contact our customer service immediately for further instructions.
- Be sure to disconnect the power supply for safety when the appliance is not in use.
- Please disconnect the power supply before maintaining and cleaning the machine.
- Always unplug the appliance when not in use; or before putting on or taking off parts and before cleaning.
- The power adapter and wire plug must not be flooded during cleaning.
- This product is for indoor use only.
- This product is not allowed to run without water.
- Never pull the electrical power cord to remove the plug from the wall outlet.
- If the plug of this device gets wet, turn off the electricity of that wall outlet. Do NOT attempt to unplug.
- Check the device after installation. Do NOT plug in if there is water on the contact points or plug.
- To avoid tripping, always position the power cord out of the way of foot traffic.
- Do not use the appliance in the bathroom.
- Replace the filter at least once every 2 weeks or when the flow rate has noticeably reduced. For two or more dogs, you may need to replace the filters more regularly if it becomes blocked.
- DO NOT put the fountain into the dishwasher, otherwise, there is a risk of deformation.

## CAUTION

- Do NOT allow pets to chew on or swallow any parts. If you are concerned about the power cord, purchase a cord conduit (a hard-plastic protector) at any hardware store to protect the power cord.
- If an extension cord is necessary, one unit with a proper rating should be used.
- Do NOT install or store the pet water fountain where it will be exposed to weather or temperatures below 0°C/ 40°F.

## Notice

The instructions for appliances having a part of **class III construction** supplied from a **detachable power supply unit** shall state that the appliance is only to be used with the power supply unit provided with the appliance.

## FCC statement

This device complies with Part 15 of the FCC Rules. Operation is subject to the following two conditions:

- (1) this device may not cause harmful interference, and
- (2) this device must accept any interference received, including interference that may cause undesired operation.

Changes or modifications to this unit not expressly approved by the party responsible for compliance could void the user's authority to operate the equipment.

**Note:** This equipment has been tested and found to comply

with the limits for a Class B digital device, pursuant to Part 15 of the FCC Rules. These limits are designed to provide reasonable protection against harmful interference in a residential installation. This equipment generates, uses and can radiate radio frequency energy and, if not installed and used in accordance with the instructions, may cause harmful interference to radio communications. However, there is no guarantee that interference will not occur in a particular installation. If this equipment does cause harmful interference to radio or television reception, which can be determined by turning the equipment off and on, the user is encouraged to try to correct the interference by one or more of the following measures:

- Reorient or relocate the receiving antenna.
- Increase the separation between the equipment and receiver.
- Connect the equipment into an outlet on a circuit different from that to which the receiver is connected.
- Consult the dealer or an experienced radio/TV technician for help.

This device and its antenna(s) must not be co-located or operated in conjunction with any other antenna or transmitter.