



**AIR**

**WiFi Feeder**

---

**@Libro Corp. All Rights Reserved.**

**Model:** PLAF108

**Manufacturer:** Shenzhen Libro Technology Co., Ltd.

**Address:** 12/F, Tower B, GALAXY WORLD, Yabao Road,  
Longgang District, Shenzhen, China

**JP Importer:** 株式会社成洋

**Made in China**

PLAF108\_V1.0

---

**FCC ID:**2A3DE-PLAF108

**IC:**28987-PLAF108

**CAN ICES-3(B)/NMB-3(B)**



This device complies with Part 15 of the FCC Rules. Operation is subject to the following two conditions: (1) this device may not cause harmful interference, and (2) this device must accept any interference received, including interference that may cause undesired operation.

# USER MANUAL

**Air WiFi Feeder**

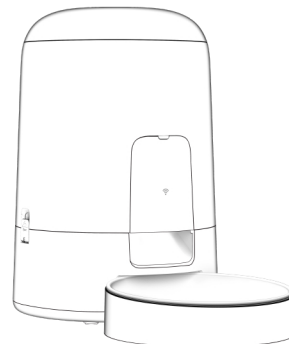

Please read this manual before using the product and keep it for future reference. Or open the PETLIBRO app and go to **DEVICE SETTINGS >** Instructions for the digital manual and instructional video.

# CONTENTS

## English

---

**01** – IN THE BOX

**02** – PRODUCT OVERVIEW

**05** – GETTING STARTED

**13** – SPECIFICATIONS

**14** – SAFETY INSTRUCTIONS

**15** – WARRANTY

**15** – NOTICE

## IN THE BOX

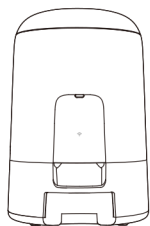

Automatic Pet Feeder

X1



Quick Start Guide

X1



Power Adapter

X1



Stainless Steel Bowl

X1



Bowl Tray

X1



User Manual

X1



Power Cable

X1

## PRODUCT OVERVIEW

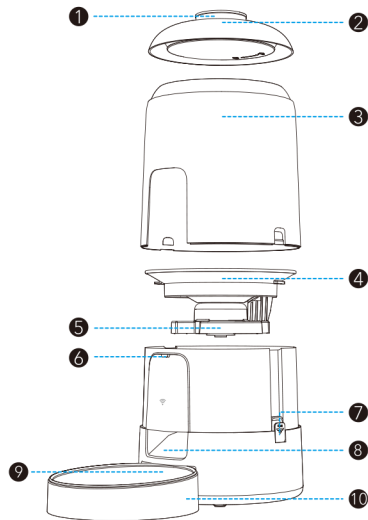

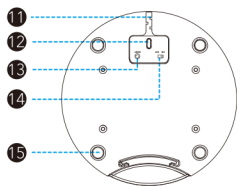

1. Lid Release Button
2. Lid
3. Food Tank
4. Tank Base
5. Rotor
6. Indicator

7. Food Tank Lock
8. Food Outlet
9. Stainless Steel Bowl
10. Bowl Tray



11. Power Cable Slot                      14. Power Switch  
 12. USB-C Power Port                    15. Non-slip Rubber Pad  
 13. Reset Button

## Buttons

Buttons	Operation
 ON OFF	Toggle the power switch to "ON" to turn on the power, and toggle to "OFF" to turn off
 Reset	Press and hold for three seconds, and the feeder will automatically reset

## Indicator Status

Indicator Status	Device Status
Off	The feeder is powered off or has a dead battery
Flashing white once every second	When the feeder is powered on and waiting for Wi-Fi connection
Flashing white once every half a second	Network configuration & OTA update
White on	Wi-Fi is connected
	The battery is fully charged
Breathing white once every second	Charging and Wi-Fi is connected
	Charging while the feeder is powered off
Breathing red once every second	Food levels are low
	The rotor is stuck
Red on	Low battery
Flashing red and white once every half a second	Wi-Fi connection failure

# GETTING STARTED

## Installation

1. Remove the food tank cover and take out the accessories.

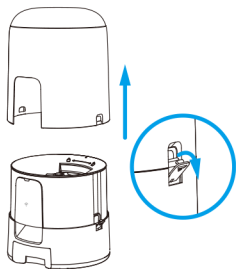

2. Connect the power cable. (Use the feeder wirelessly after fully charging its battery.)

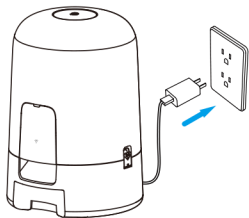

3. Toggle the power switch to "ON" to turn on the feeder.

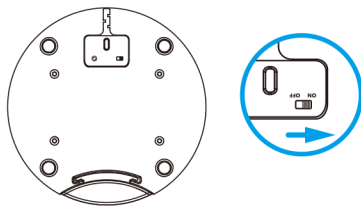

## Add pet food

1. Press the lid release button and remove the lid.

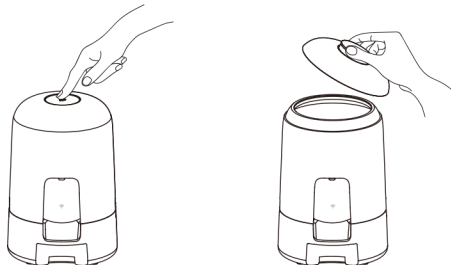

2. Add dry pet food to the food tank.



3. Replace the lid and press the lid release button.



4. Install the stainless steel bowl and bowl tray.

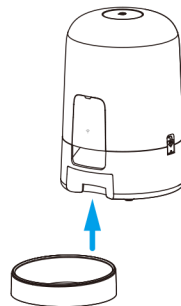

## App control

1. Scan the QR code or search in your device's app store to download and install the PETLIBRO app.



2. Follow the instructions to configure the network.

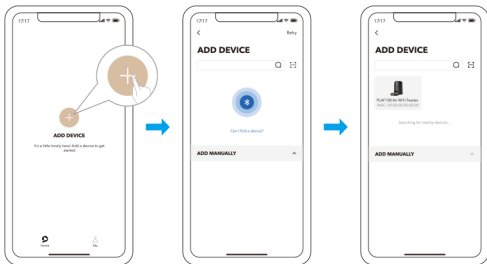

## Power off

Toggle the power switch to "OFF."

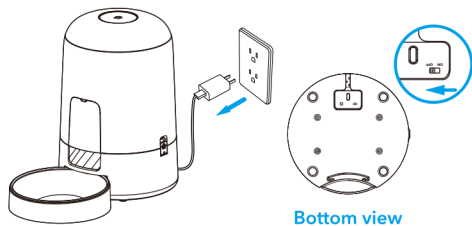

## Disassemble for cleaning

1. Pull the food tank locks outwards.

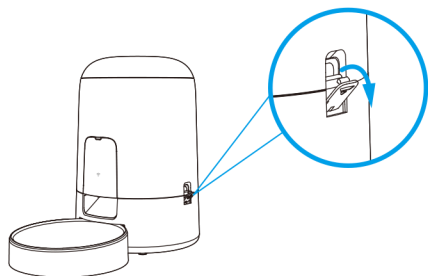

2. Lift the food tank cover.

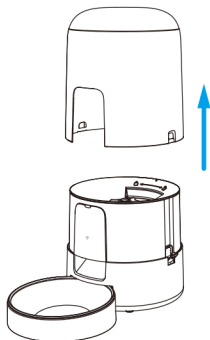

3. Hold the tank base, turn the rotor clockwise, and lift the rotor.

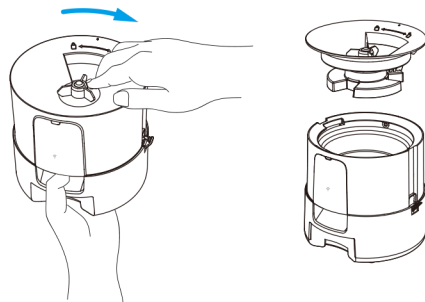

4. Clean and air-dry the rotor and food bowl.

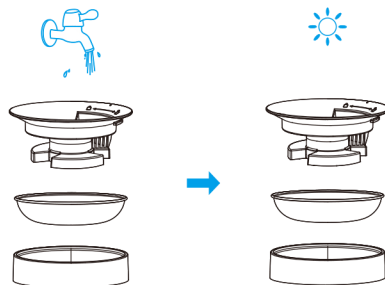



## Note



Scan the QR code above to watch the video for product installation and cleaning.

## Notes

- Power off the device before cleaning.
- Clean the food bowl with tap water.
- Do not clean the feeder in a dishwasher. Only the stainless steel bowl is dishwasher safe.
- Use a soft damp cloth to clean the feeder base. Do not wash any part with electronic components.

## SPECIFICATIONS

Model	PLAF108
Input	AC 100-240V 50/60Hz
Food tank capacity	2L
Battery capacity	5200mAh
Dimensions	310 × 265 × 180mm / 12.2 × 10.4 × 7.1in
Weight	1.3kg / 2.86lb

## SAFETY INSTRUCTIONS

- Use the feeder in a dry place.
- Use the feeder on a level surface.
- Dispose of all packaging materials properly. Some items may be packed in plastic bags; these bags could cause suffocation.
- Keep them away from children and pets.
- Do not use the feeder with pets that are not able to reach the food bowl or with any physical disability.
- Do not immerse the base part in water at any time as it may damage electronic components.
- Do not use the feeder outdoors. Check its operation frequently to be sure it is operating properly.
- Do not disassemble the feeder other than as instructed in this user manual.
- Only use accessories recommended or sold by the manufacturer. The use of accessories not recommended or sold by the manufacturer may cause an unsafe condition.
- Do not modify the feeder.
- Examine the feeder after installation. Do not plug in if there is water on the power cable or plug.
- To avoid tripping, always position the power cable out of the way of foot traffic.
- Do not install or store the feeder where it will be exposed to weather or temperatures below 0°C (32°F).
- Do not use the feeder without adding pet food first.
- Power off the feeder when it's not in use.

## WARRANTY

---

- 12-month warranty
- For guidance on product use, please contact our customer service team via email:

**support@petlibro.com.**

## NOTICE

---

### FCC statement

This device complies with Part 15 of the FCC Rules. Operation is subject to the following two conditions:

- (1) this device may not cause harmful interference, and
- (2) this device must accept any interference received, including interference that may cause undesired operation.

Changes or modifications to this unit not expressly approved by the party responsible for compliance could void the user's authority to operate the equipment.

#### NOTE:

This equipment has been tested and found to comply with the limits for a Class B digital device, pursuant to Part 15 of the FCC Rules. These limits are designed to provide reasonable protection against harmful interference in a residential installation. This equipment generates, uses and can radiate radio frequency energy and, if not installed and used in accordance with the instructions, may cause harmful interference to radio communications. However, there is no guarantee that interference will not occur in a particular installation. If this equipment does cause harmful interference to radio or television reception, which can be determined by turn-

ing the equipment off and on, the user is encouraged to try to correct the interference by one or more of the following measures:

- Reorient or relocate the receiving antenna.
- Increase the separation between the equipment and receiver.
- Connect the equipment into an outlet on a circuit different from that to which the receiver is connected.
- Consult the dealer or an experienced radio/TV technician for help.

This device and its antenna(s) must not be co-located or operated in conjunction with any other antenna or transmitter.

### Radio frequency exposure statement

To maintain compliance with the FCC's RF Exposure Guidelines, this equipment should be installed and operated with a minimum distance of 20cm from your body.