

Assembly - Step 4:

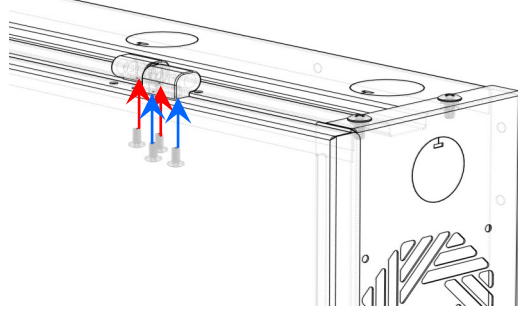

- Secure female Hinges to the Cable Enclosure Bottom with the M5x10 Screws. Make sure the hole openings are face towards each other.
- Secure 1 Male Hinge to Cable Enclosure Door Bottom with the M5x10 Screws. Insert should be facing to the outsides of the door
- Insert the installed male hinge into the female hinge. Take the remaining male hinge and insert into the opposing female hinge and secure to the door with the M5x10 Screws



For details about product warranty, please visit www.kendallhoward.com

DISCLAIMER: Kendall Howard LLC. endeavors to make this manual accurate and complete. However, Kendall Howard LLC makes no representations or warranties of any kind, expressed or implied, about whether the use of products contained herein would infringe any rights or the correctness, accuracy or reliability of the information contained herein or that said information covers all details, conditions or variations. The information herein does not provide for every possible contingency in connection with the installation or use of the product(s). The information contained in this document is subject to change without notice or obligation. Kendall Howard LLC assumes no responsibility for the accuracy, completeness or reliability of the information contained in this document. Any reliance placed on the information is therefore strictly at your own risk.

Instructions / Directions

Training Table Cable Management Enclosure
5500-3-100-36



www.kendallhoward.com

KENDALL HOWARD  TM
INNOVATORS IN PRODUCT DESIGN

Address: 10152 Liberty Lane
Chisago City, Minnesota, 55013
United States of America

Phone: 651-213-1333
Fax: 800-418-6897

Tools Needed:



Screw Driver

Included:

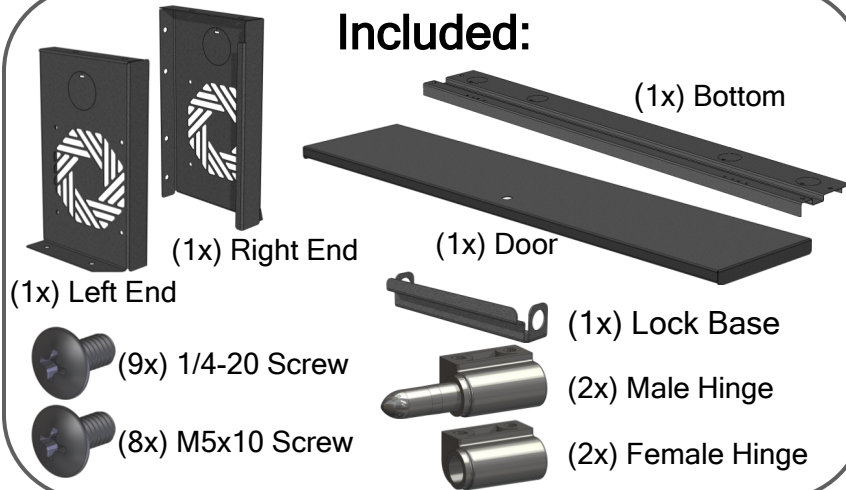

Assembly - Step 1:

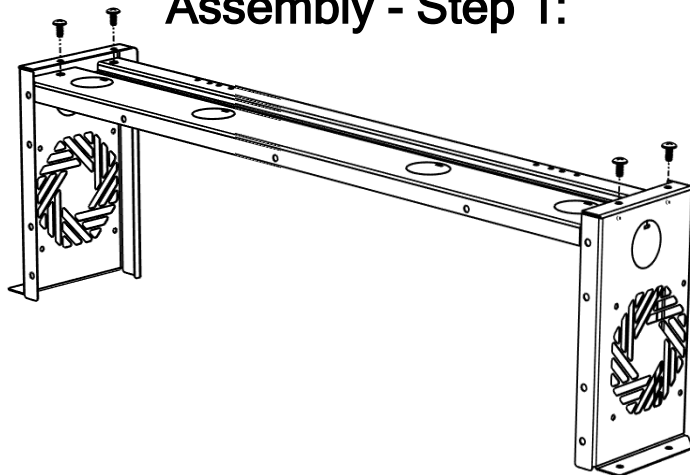

Secure right and left ends to the bottom of the Cable Management Enclosure with 1/4-20" screws

2

Assembly - Step 2:

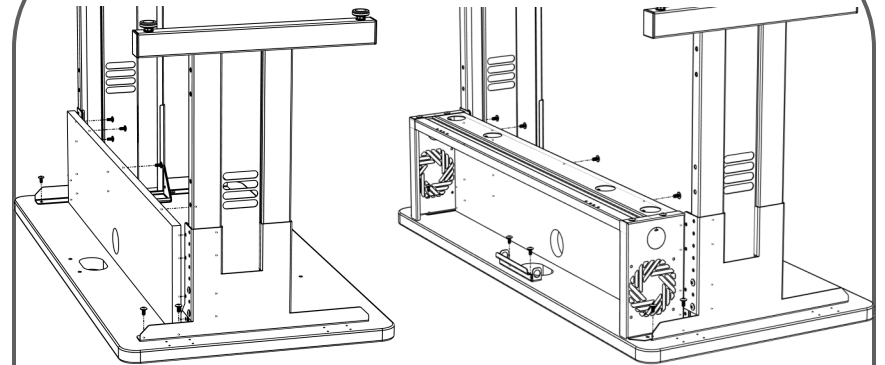

- Detach the modesty panel from the leg kit
- Remove screws from the rear leg kit that fasten it to the table top
- Slide the Cable Enclosure around the modesty panel
- Re insert screws securing the modesty panel and cable enclosure to the leg kit.

Assembly - Step 3:

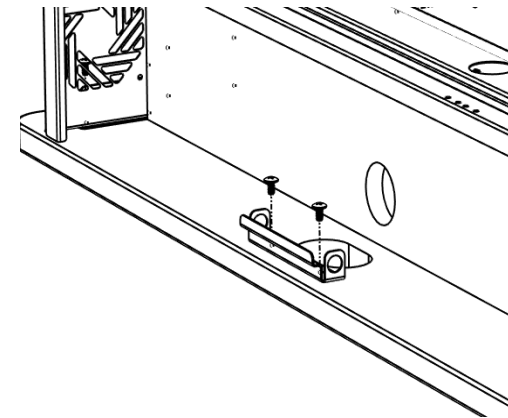

Secure the lock base just behind the grommet opening with the 1/4"-20 screws

3