



# CRYO Plus 1, 2, 3, and 4

## Model 7400 Series Liquid Nitrogen Storage System

Operating and Maintenance Manual 7007400 Rev. 21

Visit us online to register your warranty  
[www.thermoscientific.com/labwarranty](http://www.thermoscientific.com/labwarranty)

**Thermo**  
SCIENTIFIC

**MANUAL NO. 7007400**

21	40080/FR-2782	9/25/15	Added RJ-11 cable to Parts List on page 6-1	ccs
20	40080/40131	4/2/15	Added lid closure warnings, gas spring note and RJ-11 to parts list	ccs
19	30520/SI-12108	3/12/14	Added T/C probe replacement kit numbers to pg 6-2	ccs
18	30510/FR-2563	10/24/13	Updated spring part numbers and added lid magnet on Parts List.	ccs
17	30016/FR-2488	5/29/13	Corrected switch position on pg 3-4	ccs
16	29194/FR-2440	1/23/13	Updated schematics to current production, no TS outlet, misc.	ccs
15	28511/FR-2371	7/26/12	Corrected elec schematics (RS-232 connector wiring), RS-232 & remote alarm connectors - Section 1, opt. printer kit - pg 2-6	ccs
14	26806/SI-10941	9/22/11	Updated schematics with level sensors, various other clarifications	ccs
13	27339	7/5/11	Revised pgs 1-3 through 1-6, 2-1, 5-1 and removed accessories from Section 6	ccs
12	25696	10/6/10	Added S1 settings to pg 3-4 per D. Ponder	ccs
11	25763/FR-2099	10/29/09	Added vent port warnings and thawing notes (pgs 2-2 & 4-3)	ccs



**Important** Read this instruction manual. Failure to read, understand and follow the instructions in this manual may result in damage to the unit, injury to operating personnel, and poor equipment performance. ▲

**Caution** All internal adjustments and maintenance must be performed by qualified service personnel. ▲

Material in this manual is for information purposes only. The contents and the product it describes are subject to change without notice. Thermo Fisher Scientific makes no representations or warranties with respect to this manual. In no event shall Thermo be held liable for any damages, direct or incidental, arising out of or related to the use of this manual.

**Note** This equipment is Installation (Overvoltage) Category II, Pollution Degree 2. ▲

©1998 Thermo Fisher Scientific. All rights reserved.



Important operating and/or maintenance instructions. Read the accompanying text carefully.



Potential electrical hazards. Only qualified persons should perform procedures associated with this symbol.



Extreme temperature hazards. Only qualified persons should perform procedures associated with this symbol.



Equipment being maintained or serviced must be turned off and locked off to prevent possible injury.



Potential biological hazards. Proper protective equipment and procedures must be used.



Marking of electrical and electronic equipment, which applies to electrical and electronic equipment falling under the Directive 2002/96/EC (WEEE) and the equipment that has been put on the market after 13 August 2005.



This product is required to comply with the European Union's Waste Electrical & Electronic Equipment (WEEE) Directive 2002/96/EC. It is marked with the WEEE symbol. Thermo Fisher Scientific has contracted with one or more recycling/disposal companies in each EU Member State European Country, and this product should be disposed of or recycled through them. Further information on Thermo's compliance with this directive, the recyclers in your country and information on Thermo Scientific products will be available at [www.thermofisher.com](http://www.thermofisher.com).



**Warning** Whenever working with liquid nitrogen storage equipment in a closed environment, the use of personal O<sub>2</sub> detection equipment is strongly recommended. ▲

- ✓ Always use the proper protective equipment (clothing, gloves, goggles, etc.)
- ✓ Always dissipate extreme cold or heat and wear protective clothing.
- ✓ Always follow good hygiene practices.
- ✓ Each individual is responsible for his or her own safety.

## Do You Need Information or Assistance on Thermo Scientific Products?

If you do, please contact us 8:00 a.m. to 6:00 p.m. (Eastern Time) at:

1-740-373-4763

1-800-438-4851

1-877-213-8051

<http://www.thermoscientific.com>

[service.led.marietta@thermofisher.com](mailto:service.led.marietta@thermofisher.com)

[www.unitylabservices.com](http://www.unitylabservices.com)

Direct

Toll Free, U.S. and Canada

FAX

Internet Worldwide Web Home Page

Tech Support Email Address

Certified Service Web Page

Our **Sales Support** staff can provide information on pricing and give you quotations. We can take your order and provide delivery information on major equipment items or make arrangements to have your local sales representative contact you. Our products are listed on the Internet and we can be contacted through our Internet home page.

Our **Service Support** staff can supply technical information about proper setup, operation or troubleshooting of your equipment. We can fill your needs for spare or replacement parts or provide you with on-site service. We can also provide you with a quotation on our Extended Warranty for your Thermo Scientific products.

Whatever Thermo Scientific products you need or use, we will be happy to discuss your applications. If you are experiencing technical problems, working together, we will help you locate the problem and, chances are, correct it yourself...over the telephone without a service call.

When more extensive service is necessary, we will assist you with direct factory trained technicians or a qualified service organization for on-the-spot repair. If your service need is covered by the warranty, we will arrange for the unit to be repaired at our expense and to your satisfaction.

Regardless of your needs, our professional telephone technicians are available to assist you Monday through Friday from 8:00 a.m. to 6:00 p.m. Eastern Time. Please contact us by telephone or fax. If you wish to write, our mailing address is:

Thermo Fisher Scientific  
401 Millcreek Road, Box 649  
Marietta, OH 45750

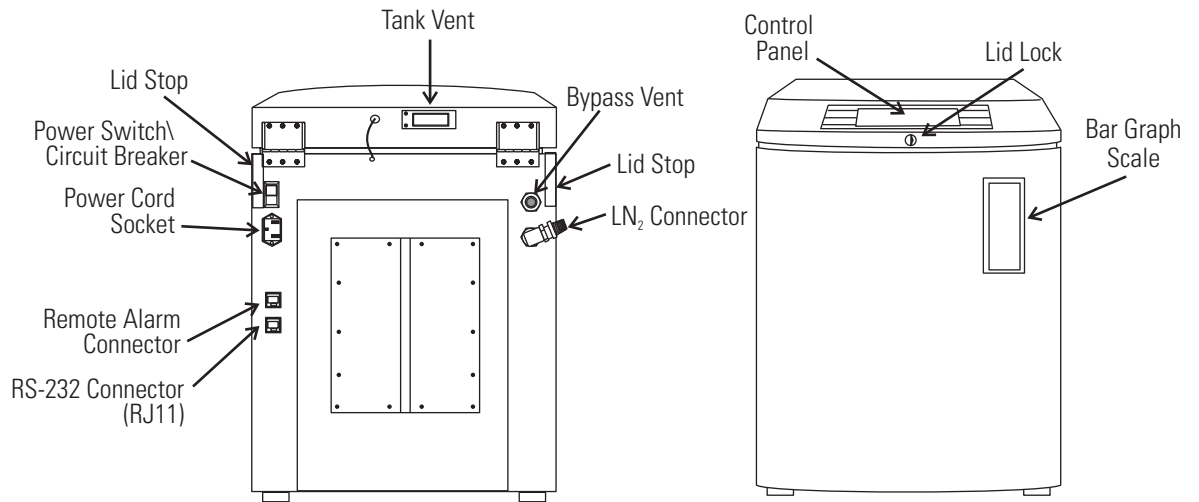
International customers, please contact your local Thermo Scientific distributor.

# Table of Contents

<b>Section 1</b>	<b>Quick Start-Up</b> .....	<b>1-1</b>
	Connect Liquid Nitrogen Transfer Hose .....	1-2
	Attach Power Cord .....	1-2
	Connect Lid Strap (Model 7406/7407) .....	1-4
	Connect to Electrical Supply .....	1-4
	Install Optional Platform Riser .....	1-5
	Install Temperature Sleeve .....	1-5
	Fill Unit .....	1-5
	Remote Alarm Connector .....	1-6
	RS-232 Interface Connector .....	1-7
	Installation Verification .....	1-7
<b>Section 2</b>	<b>Operation</b> .....	<b>2-1</b>
	Bar Graph .....	2-3
	Program Controller .....	2-3
	Change High Level (Stop Filling) Setpoint .....	2-4
	Change Low Level (Start Filling) Setpoint .....	2-4
	Set Microprocessor Internal Clock .....	2-5
	Change High Temperature Alarm Setpoint .....	2-5
	The Optional Control Printer Kit .....	2-6
<b>Section 3</b>	<b>Troubleshooting the Alarms</b> .....	<b>3-1</b>

<b>Section 4</b>	<b>Maintenance</b> .....	<b>4-1</b>
	General Cleaning .....	4-2
	Defrosting the Vent Port .....	4-3
	Defrosting the Storage Tank .....	4-3
<b>Section 5</b>	<b>Specifications</b> .....	<b>5-1</b>
<b>Section 6</b>	<b>Parts List</b> .....	<b>6-1</b>
<b>Section 7</b>	<b>Electrical Schematics</b> .....	<b>7-1</b>
<b>Section 8</b>	<b>Warranty Information</b> .....	<b>8-1</b>
<b>Appendix A</b>	<b>Handling Liquid Nitrogen</b> .....	<b>9-1</b>
	Introduction .....	9-1

## Section 1 Quick Start-Up



**Figure 1-1.** Component Locations

Locate the storage container in a well ventilated area of the laboratory, with adequate work space available for loading and unloading specimens. Allow for adequate lid opening clearance.

This unit is designed to operate in the following environmental conditions:

Temperature: 5°C (41°F) to 40°C (104°F)

Humidity: 80% at <31°C, decreasing linearly to 50% at 40°C.

Altitude: < 2,000 meters (6,650 feet)

**Warning** Whenever working with liquid nitrogen storage equipment in a closed environment, the use of personal O<sub>2</sub> detection devices is strongly recommended. Refer to “Handling Liquid Nitrogen” in the appendix at the end of this manual. ▲

**Warning** Ensure there are no physical objects that can contact the open lid and cause an accidental closure. If the unit is not placed against a solid wall, verify a physical barrier is installed at the base to prevent unit movement while working in it. ▲



## Connect Liquid Nitrogen Transfer Hose

The container should be located near the liquid nitrogen supply, allowing enough space for nitrogen source tank replacement. Arrangements should be made to collect the condensate, which will form on the transfer hose.

A four foot nitrogen transfer hose with a 1/2" flare fittings is supplied with Model 7400/7401. A six foot hose is standard with Models 7402/7403, 7404/7405 and 7406/7407. The use of a transfer hose longer than six feet may degrade system performance.

**Caution** The flair connection on the ends of the transfer hose does not require any sealant. Pipe dope or sealing tape may cause contamination of the liquid fill solenoid, or leaks at the hose connections. ▲

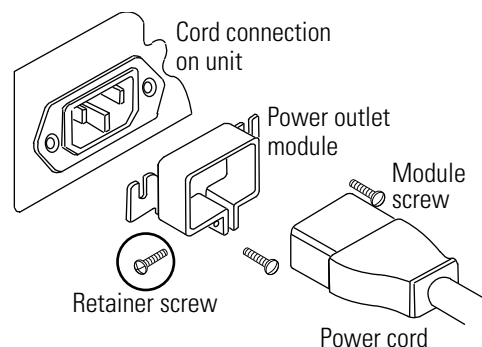
The storage system requires a user supplied low pressure regulated (22 PSIG) liquid nitrogen supply. Anything higher than 22 PSI will degrade performance of the CryoPlus storage container.

Connect the transfer hose packed with the CryoPlus unit between the low pressure, liquid outlet of the liquid nitrogen supply tank (22 PSIG) and the storage container.

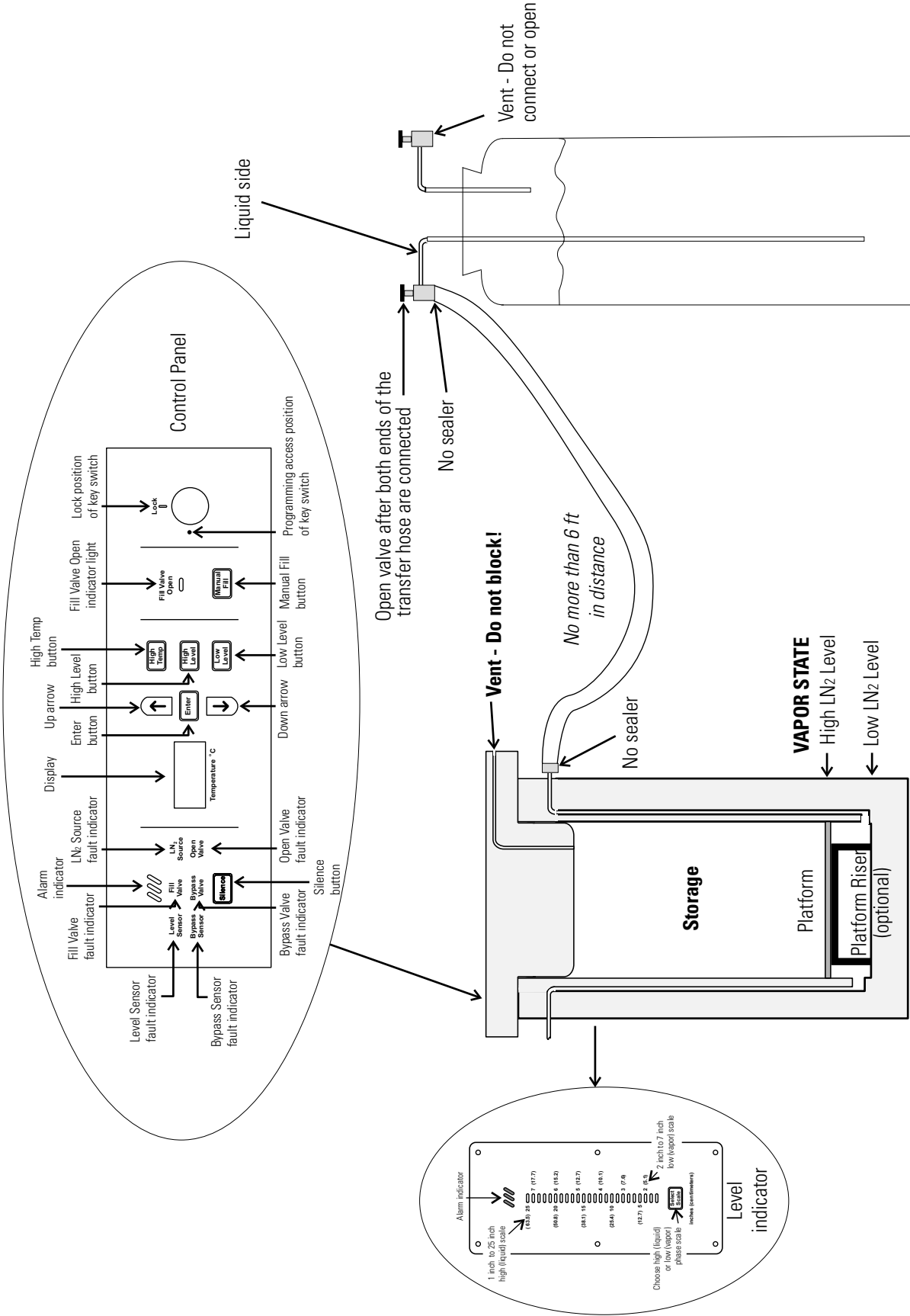
After the transfer hose has been connected, open the supply tank valve and check the connections for leaks.

## Attach Power Cord

1. Loosen screw located on the power cord retainer. Spread the retainer.
2. Insert the power cord into the power outlet module. Tighten screw on the power cord retainer.
3. Fit the power cord/outlet module assembly into the connection on the unit. Tighten the module screws to secure the cord to the unit.



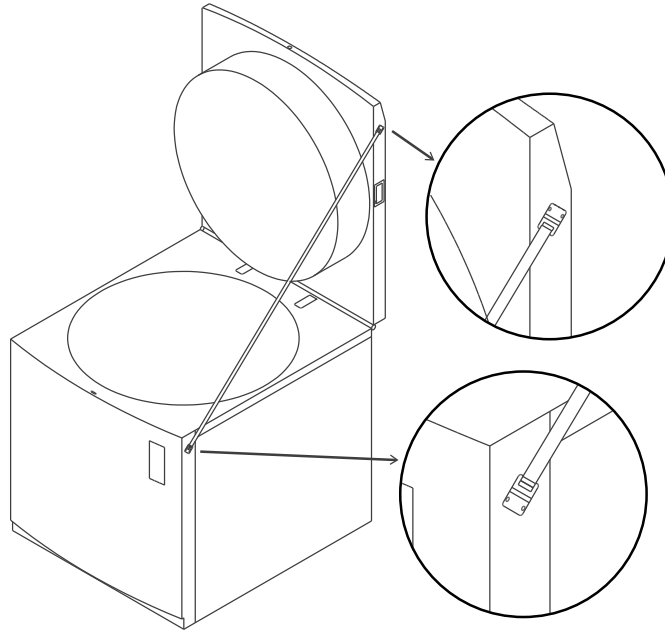
**Figure 1-2.** Power Cord



## Connect Lid Strap (Model 7406/7407)

Included with each unit is a lid strap for the user's convenience.

1. Remove the protective white nylon screws from the areas indicated. Discard these screws.
2. Install the strap as shown below, using the screws included with the strap.



**Figure 1-3.** Lid Strap Installation

## Connect to Electrical Supply

With the power switch turned OFF, connect the unit to a grounded electrical outlet. See the data plate on the back of the unit, or the electrical schematics included in this manual, for voltage and full load amps.

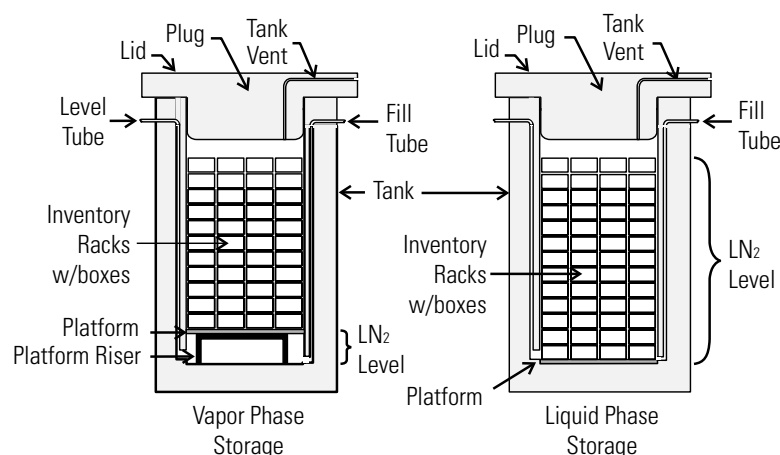
The power switch on the back of the unit is the mains disconnect and is also a reset-type circuit breaker. If an overload condition occurs, the built-in circuit breaker will trip and the power switch will turn off. Turning the power switch on resets the circuit breaker. If the circuit breaker trips again within a short time period, the unit should be checked by a qualified electrician.

**Warning** Use only a grounded electrical receptacle. Failure to ground the unit can result in serious injury. ▲

## Install Optional Platform Riser

Depending on the inventory control system chosen, install the platform riser (if applicable) as shown in Figure 1-4.

**Note** In the liquid phase, the standard platform remains in the bottom of the tank. ▲



**Figure 1-4.** Platform Riser

## Install Temperature Sleeve

A Temperature Sleeve is designed to assist the temperature gradient within the unit so that in a normal vapor phase setting of 3-5 inches of liquid, the air temperature encompassed within the sleeve remains below  $-130^{\circ}\text{C}$ . The sleeve is standard on all CryoPlus units and is installed when shipped from the factory.

When properly installed, the ends of the sleeve are aligned with the temperature probe at the rear of the tank, and the square holes in the bottom of the sleeve are aligned with the fill and pressure ports.

**Caution** It is imperative that the positioning of the sleeve not block either the fill or liquid level tube orifices located at the bottom rear of the tank. Should blockage occur, it will cause filling and liquid level indicator problems. ▲

## Fill Unit

When shipped from the factory, the liquid nitrogen level settings of all CryoPlus units are set at Vapor Phase settings of five inches high limit, three inches low limit (factory defaults). It is not recommended that these settings be changed until the unit has been filled for the first time and allowed to stabilize.

**Caution** The lid must remain open throughout the initial filling of the storage container. ▲

## Fill (continued)

When electric power and LN<sub>2</sub> have been connected, open the lid and turn on the power switch to begin filling the unit. Because the unit must go from ambient room temperature to -196°C, considerable boiling of the liquid nitrogen takes place, turning into super-cooled nitrogen gas which flows over the side of the open chamber. As this occurs, frost becomes visible around the top of the unit. This is normal during the initial fill with the lid open and disappears once the unit has stabilized.

As the unit fills, the bar graph on the front of the cabinet monitors the progress by displaying the liquid level (green lights), the high and low limit set points (flashing orange). Refer to Section 2. The storage container fills until the liquid Nitrogen reaches the high level set point and the 5-inch flashing orange LED changes to flashing red. The LN<sub>2</sub> storage container is now in full automatic operation.

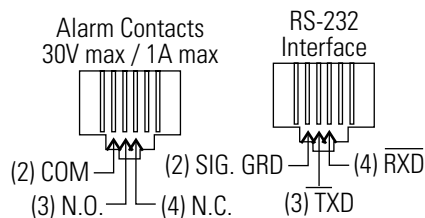
After the initial fill is complete, close the lid and allow the unit to stabilize for a minimum of 8 hours, before changing the high or low level setpoints or adding inventory.

**Caution** Some popping or cracking noises may be heard after the unit is initially filled and the lid is opened and closed the first few times. This is normal and quickly disappears. ▲

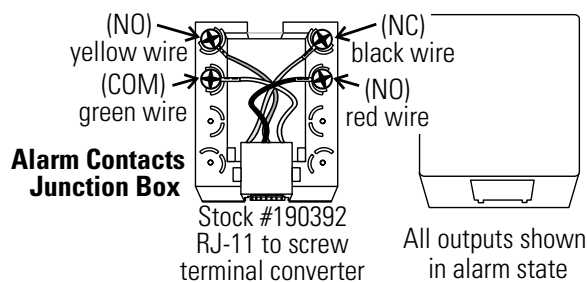
**Note** If the lid is opened frequently, condensation can occur on the vent port, causing icing of the port. See the maintenance section for defrost information. ▲

## Remote Alarm Connector

The CryoPlus control system provides remote alarm contacts, wired to an RJ-11 connector on the back of the cabinet. Figure 1-4 identifies the pin designations.



**Figure 1-4.** RS232 and Remote Alarm Connector Pin Designations



**Figure 1-5.** Optional Alarm Contacts Junction Box Wiring

## **RS-232 Interface Connector**

The CryoPlus storage system is equipped with an RS-232 Serial Communication Interface for the remote transmission of data. An RJ-11 telephone style connector is located on the rear of the cabinet. Figure 1-4 identifies the pin designations.

The RS-232 provides information to a serial printer or terminal via the following protocol:

- 9600 Baud
- 1 Stop Bit
- No Parity
- 8 Data Bits

## **Installation Verification**

The following procedures test key elements of the CryoPlus Freezer system and verify the unit's installation. These tests can be performed at the operator's discretion. If any of these tests fail, contact the Technical Service Department or your local Thermo sales representative.

### **LN<sub>2</sub> Supply**

The source tank should indicate that it is full and the pressure to the Cryo unit regulated at 22 PSIG. Check all connections.

### **Temperature Sleeve**

When installed, the ends of the sleeve must align with the temperature probe at the back of the tank and the pressure and fill ports are visible through the square holes at the bottom of the sleeve.

### **Power Switch**

Turn the unit on with the power switch located on the back of the unit. Under normal conditions, all LEDs on the control panel and bar graph, with the exception of the alarm LEDs illuminates for approximately 2-3 seconds. The power switch is the main disconnect for the system.

### **Keypad**

Press each button on the control panel, listening for a "beep" response.

### **Control Panel Key Switch**

Turn the key switch to the Programming Access position (.). Control panel temperature display indicates alarm setpoint temperature. Turn the key to Lock position and the display shows actual chamber temperature.

## Installation Verification (cont.)

### LED Test

Turn the unit off. Turn the key switch to the Programming Access position. Turn the unit on while pressing and holding the Low Level button for four seconds. Press Manual Fill to begin the test. When all LEDs have cycled, turn the unit off to reset the system.

### Remote Alarm Contacts

With the contacts wired to a remote alarm, turn the unit on, wait a few seconds, then turn the unit off. The alarm should activate immediately.

### Manual Fill

Turn the key switch to the Programming Access position. Press the Manual Fill button. The fill indicator will light and the unit will begin filling the chamber. If the LN<sub>2</sub> level is more than one inch below the high level setpoint, the liquid nitrogen will continue to flow after Manual Fill is released until the high level setpoint is reached. To stop filling before high level, turn the unit off, then on. If LN<sub>2</sub> is already in the tank and the level is less than one inch below the high level setpoint, filling will stop when Manual Fill is released.

### Programming Access Test

With the unit turned on, turn the key to the Programming Access position. The control panel display shows the high temperature alarm setpoint.

Press High Level, then the up or down arrow. The setpoint moves accordingly.

Press Low Level, then the up or down arrow. The setpoint moves accordingly. Return the key to Lock. The control panel display shows thermocouple temperature and bar graph shows new high and low level setpoints.

**Note** The unit returns to factory default settings unless setpoints were saved in above tests by pressing Enter. ▲

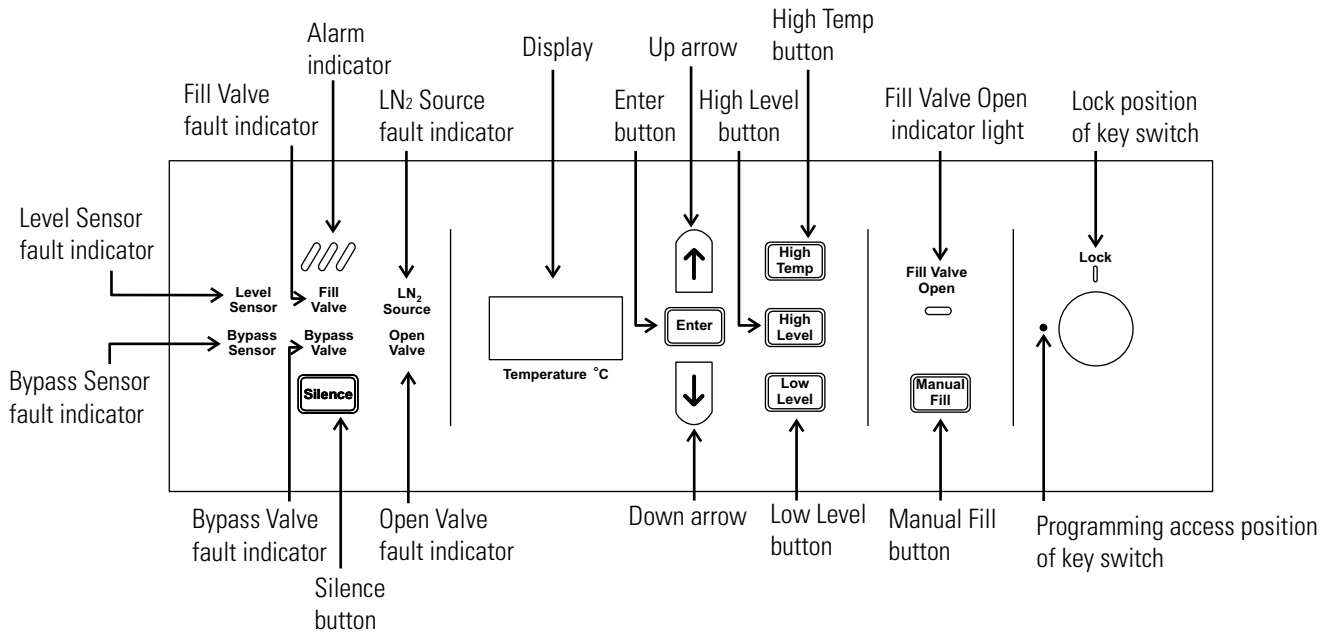
### Dip Level Test

This test compares the liquid level shown on the bar graph with the actual level in the tank, using the ruler supplied with the unit. With the tank filled and stable, lower the ruler along the edge of the tank until it is at the bottom. (Take subsequent measurements at this same location.) When the LN<sub>2</sub> stops boiling, pull out the ruler. The actual liquid level will be approximately one inch lower than the frost line on the ruler.

Compare this with the level shown on the bar graph. Measuring tolerance for the low scale (2" to 7") is  $\pm 1/2$  inch. Measuring tolerance for the high scale (1" to 25") is  $\pm 1$  inch.

**Caution** Some shrinkage of the ruler may occur, depending on the level of liquid nitrogen in the tank. ▲

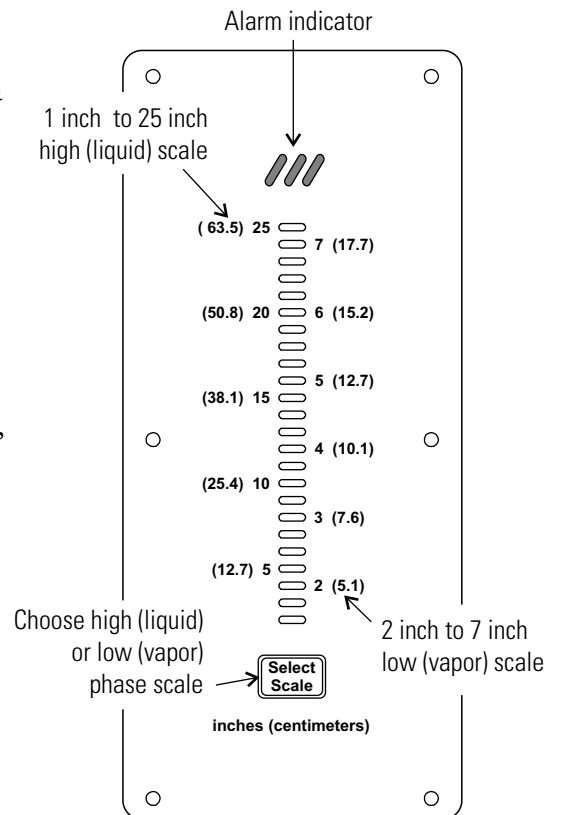
# Section 2 Operation



**Figure 2-1.** Control Panel Elements

All functions of this CryoPlus storage unit are controlled by a programmable microprocessor. Commands to the control system are given using the control panel on the cabinet lid (Figure 2-1). A multi-colored bar graph on the front of the cabinet shows the status of the system, indicating the liquid level inside the chamber, and the high level (stop fill) and low level (start fill) points. See Figure 2-2.

**Warning** Do not use the unit as a work surface. The lid should be closed except during loading and unloading. ▲



**Figure 2-2.** Level Indicators and Setpoints



The elements on the left side of the control panel illuminate when fault conditions occur, providing information about the alarm state. Refer to Section 3 of this manual.

A three element alarm bar illuminates during an alarm condition to visually alert the operator. The Silence button is used to silence the audible alarm. Refer to the alarm descriptions and corrective actions in Section 3 of this manual.

Other elements of the control panel are:

- A three digit display, showing the thermocouple temperature when the keyswitch is in the Lock position. The thermocouple junction is located 4½ to 5½ inches below the lid on Models 7400 through 7405, and 5½ to 6½ inches below the lid on Models 7406 through 7407. When the key is in the Programming Access (.) position, the display shows the High Temperature Alarm set point.
- Enter button, used to send programming changes to the microprocessor.
- Up and down arrows that change the high and low level settings when making programming changes, are also used to change the high temperature alarm setpoints.
- High Level button, changing the level at which the system stops filling.
- Low Level button, pressed to change the level at which the system starts filling.
- High Temp button, changing the temperature at which the high temperature alarm activates.
- Manual Fill button, pressed to manually fill the tank. The level must be at least 1-1/4 inches below the high level setpoint to start a manual fill.
- Fill Valve Open light, indicating the fill valve is open.
- Key switch, used to allow program changes when the key is in the (.) Programming Access position and to protect the system from tampering or accidental button presses when the key is in the Lock position.

## Bar Graph

Located on the front of the CryoPlus cabinet, the tri-color, 24 light bar graph displays the liquid level inside the chamber, and (start fill) low level and (stop fill) high level setpoints (Figure 2-2).

A Scale Select button at the base of the bar graph toggles the scale between the high (liquid phase) and low (vapor phase) scales. Refer to Figure 2-2. Numbers in parenthesis are the metric equivalents.

The left side scale is for settings from 1-inch to 25-inches in 1 inch increments.

The right side scale is for settings from 2-inches to 7-inches in 1/4" increments (vapor scale). The three light bars at the top of the level panel are visible alarm lights that coincide with the alarms indicated on the top control panel on the lid.

The three colors of the bar graph (Figure 2-3) are:

Orange (steady) indicates the remaining space above the high level setpoint.

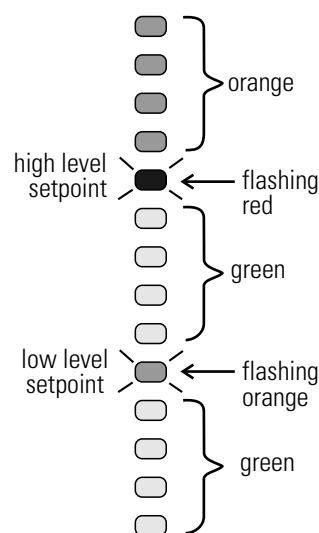
Orange (flashing): Under normal conditions, the flashing upper LED is the high level (stop fill) setpoint, and the flashing lower LED is the low level (start fill) setpoint.

Green indicates the actual liquid Nitrogen level.

Red (steady) indicates the amount of space below or above setpoint from the actual liquid level.

Red (flashing) indicates that the liquid level is above or below the level set points. A possible alarm condition is pending.

Single Red (flashing) after a fill operation indicates that the liquid level is at the high level setpoint. This is not an alarm condition.



**Figure 2-3.** Bar Graph Colors

## Program Controller

**Caution** The Key Switch must be in the Programming Access (.) position to program the controller or to access any Touch Pad function. The Controller will automatically return to the lock position, even though the key is in the Access (.) Position, if no entry is made on the key pad within four (4) minutes. On the high scale (left side, 2" - 25"), the high and low level setpoints must be at least 3" apart. On the low scale (right side, 1.5" - 7.25"), the high and low level setpoints must be at least 1.25" apart. ▲

## Change High Level (Stop Filling) Setpoint

Refer to Figures 2-1 and 2-2.

1. Turn the key switch to the Programming Access position (.) and verify that the desired scale is selected on the Bar Graph.
2. If the yellow Fill Valve Open indicator is lit, the system is in Fill Mode.
3. Press High Level.
4. Press the up arrow to raise the high level setpoint. A flashing orange LED will begin to move upward. Release the up arrow when it reaches the desired level on the bar graph. If lowering the high level (stop filling) setpoint, press the down arrow. The flashing orange LED will begin to move downward.
5. Release the down arrow when the stop filling (high level) setpoint is reached.
6. Press Enter to store the new setting in the microprocessor memory. Return the key switch to the Lock position.

## Change Low Level (Start Filling) Setpoint

Refer to Figures 2-1 and 2-2.

1. Turn the key switch to the Programming Access position (.) and verify that the Bar Graph is set to the desired scale.
2. If the yellow Fill Valve Open indicator is lit, the system is in the fill mode.
3. Press Low Level.
4. Press the up arrow to raise the low level (start filling) setpoint. A flashing orange LED will begin to move upward. Release the up arrow when it reaches the desired level on the bar graph.
5. If lowering the low level (start filling) setpoint, press the Down Arrow. The flashing orange LED will begin to move downward. Release the Down Arrow when the low level (start filling) setpoint is reached.
6. Press Enter to store the new setting in the microprocessor memory. Return the key switch to the Lock position.

**Note** Depending on the new setpoints, filling will not begin until the chamber liquid level falls below the new low level setpoint. ▲

## **Change High Temperature Alarm Setpoint**

The High Temperature Alarm Setpoint is the temperature at which the high temperature alarm activates.

1. Turn the key switch to the Programming Access position (.). The digital display will indicate the current High Temperature Alarm set point.
2. Press High Temp. Three decimal points in the digital display will flash on and off.
3. Press the up arrow to raise the temperature alarm setpoint or the down arrow to lower it.
4. The Enter button must be pressed after the desired high temperature alarm point is displayed.

When programming is complete, turn the key switch to the Lock position [.] . The thermocouple temperature will be displayed once again, and the controller will now operate at the new setpoint.

## **Set Microprocessor Internal Clock**

The "real time" internal clock enables alarms, program changes, and current system status to be printed relative to the actual time and date of occurrence. This information is made available through the RS-232 data port.

The factory default setting is Eastern Standard Time (USA).

To set the clock, start with the unit turned off.

1. Turn the key switch to Full Access (.). Press the High Level button on the key pad while turning on the power switch located on the back of the unit.
2. Starting from the bottom of the bar graph, the first LED on the bar graph lights and the numeric display on the control panel shows the current time hundredths of seconds.
3. Press the up arrow (to increase) or down arrow (to decrease) the setting.

## Set Clock (continued)

4. Press the Enter key to lock in the value and advance to the next setting. The chart below shows the settings in sequence.

LED lights*	Clock Setting
1	.hundredths of seconds
2	.seconds
3	.minutes
4	.hours (in military time)
5	.day of the week
6	.day of the month
7	.month
8	.year

\*LED on the Bar Graph, starting at the bottom of the graph and counting upward.

## The Optional Control Printer Kit

**Note** Install the Modular Line Filter included with the kit into the RS-232 interface connector on the rear of the unit. ▲

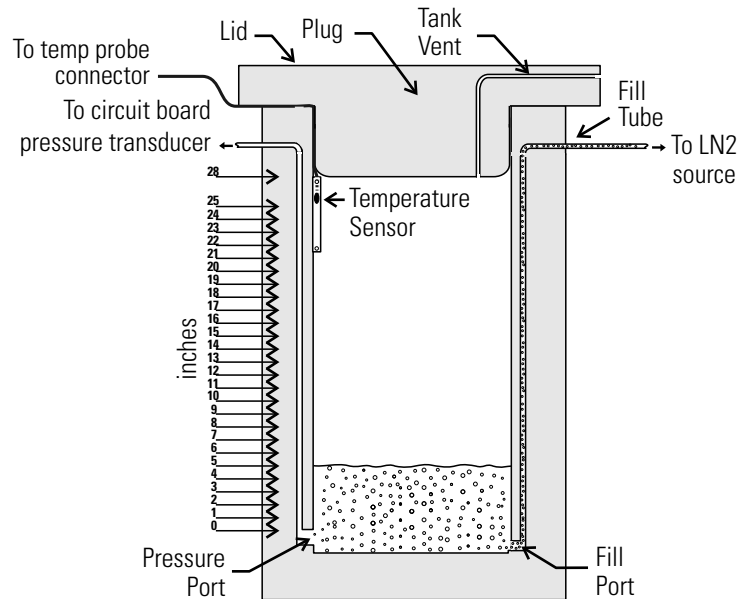
The printer (kit P/N 4000565 US/4000665 EU) provides the following information:

**Note** All functions and error codes, when printed, include the current LN<sub>2</sub> level, temperature, time, and date. ▲

- Power up
- Auto fill cycle
- Manual fill start and scale selection
- Manual fill stop and scale selection
- Changes in program settings
- Cover opened (tank lid opened)
- All error codes

**Note** Automatic printing every two hours is the factory default. This feature can be programmed to occur from once every hour to once every 24 hours. Contact the Technical Services Department. ▲

## Section 3 Troubleshooting the Alarms



**Figure 3-1.** Component Locations

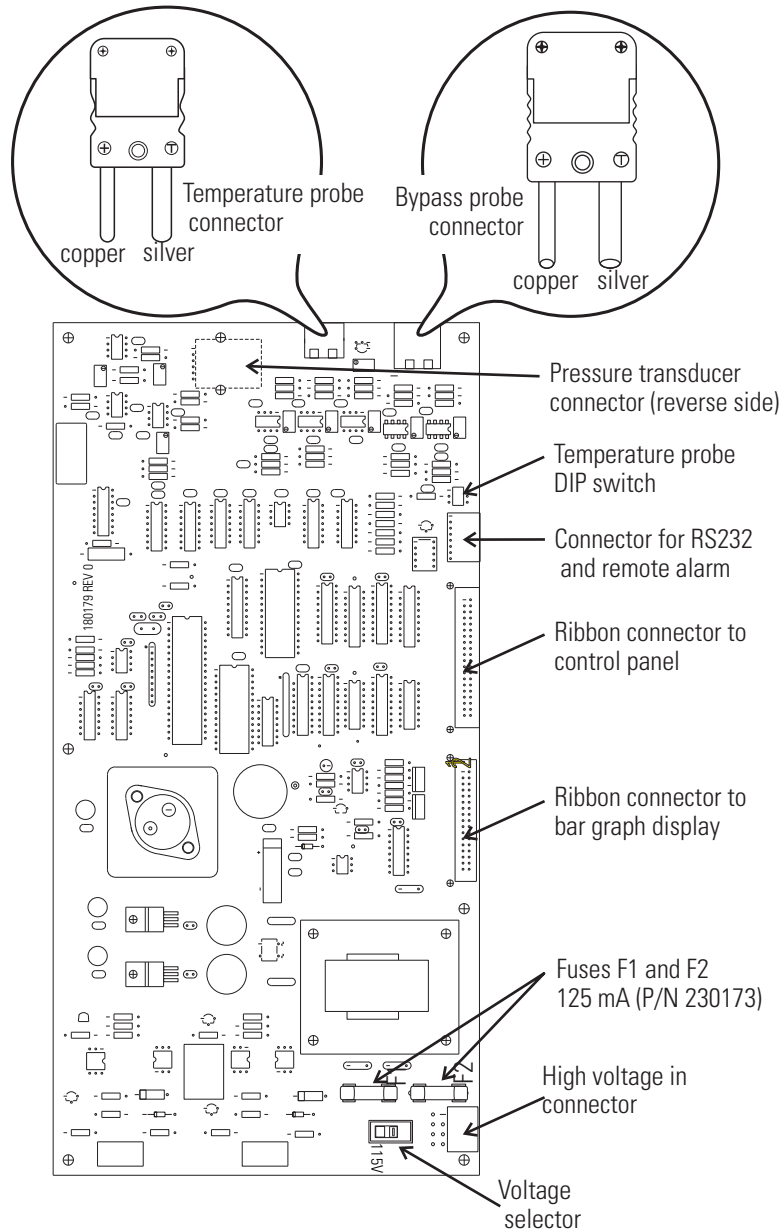
Refer to the alarm descriptions, probable causes and corrective action information at the end of this section. Use the above system illustration for reference.

**Warning** Potential electrical hazards exist in this equipment. Only qualified persons should perform the instructions and procedures described in this section. ▲

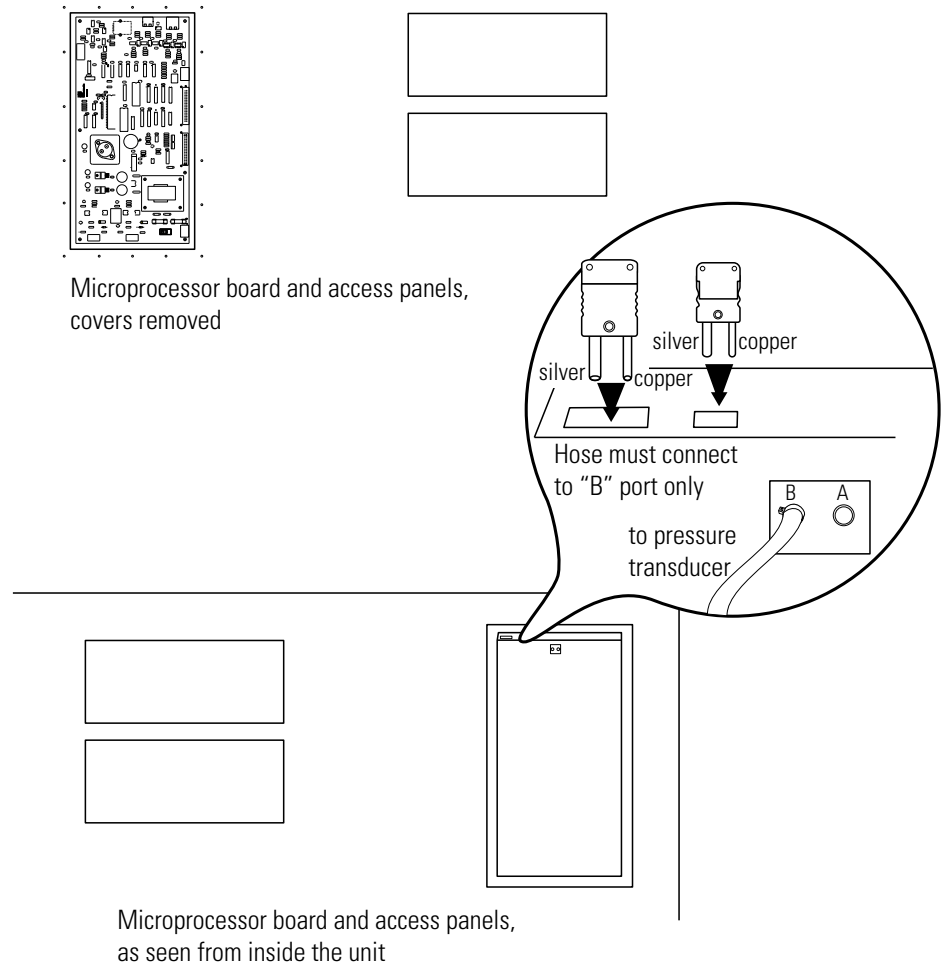
**Warning** Ultra low temperatures are associated with this equipment. Instructions in this section should only be carried out when using special handling equipment or when wearing special, protective clothing. ▲

In addition to the protection provided by the power switch/ circuit breaker, two North American UL and/or CSA, 125 mA, 250 VAC Slo-Blow fuses (P/N 230173) are located on the microprocessor circuit board. Refer to Figure 3-2. To access these fuses, remove the cabinet back panel.

**Warning** This service should only be performed by qualified personnel. ▲

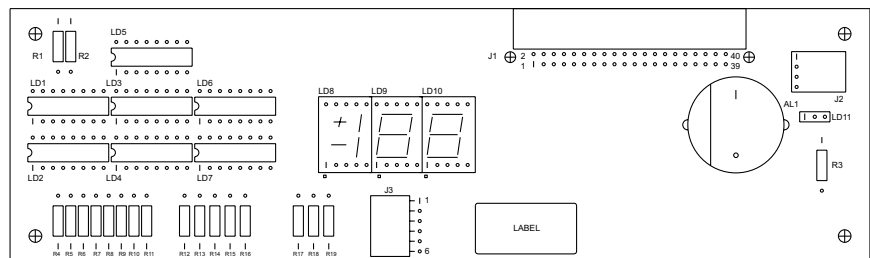


**Figure 3-2.** Microprocessor Circuit Board



**Figure 3-3.** Inserting Connectors From Inside the Cabinet

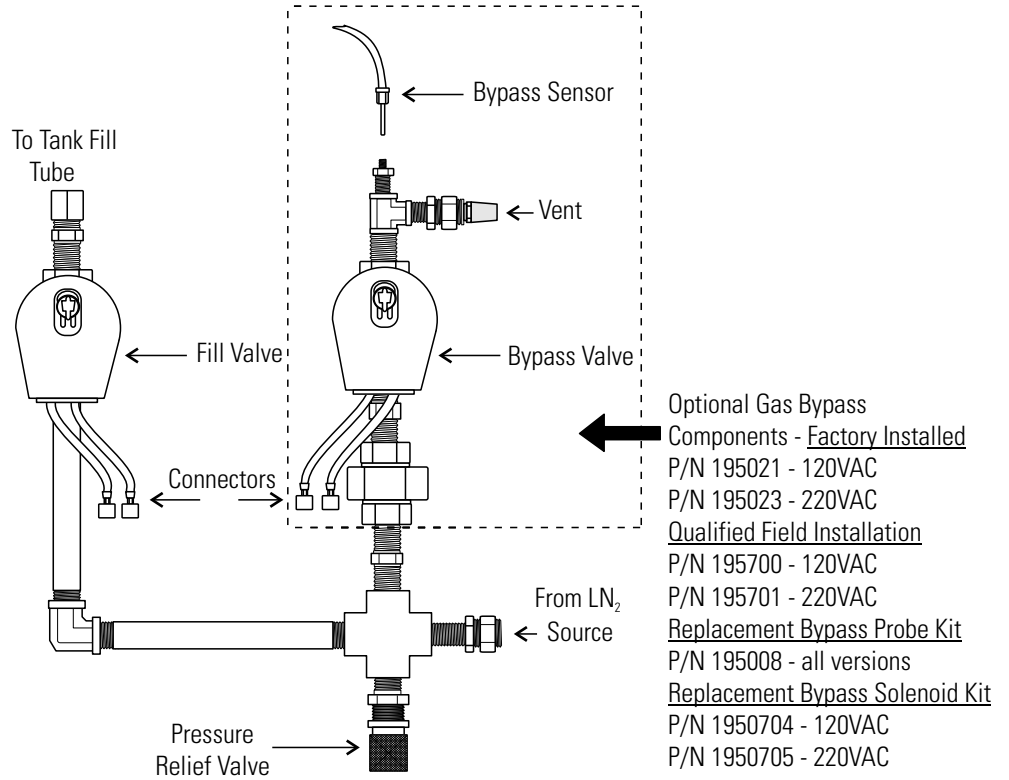
Access the control panel circuit board (below) by lifting off the plastic frame surrounding the front of the panel and removing the Phillips screws.



**Figure 3-4.** Control Panel Circuit Board



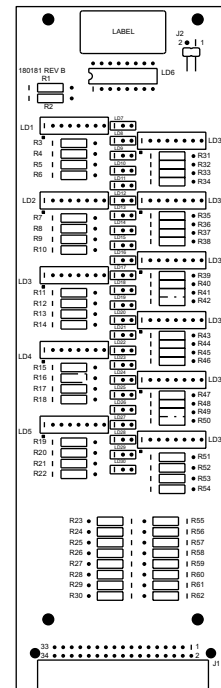
**Section 3**  
Troubleshooting the Alarms



**Figure 3-5.** Mechanical Block Diagram

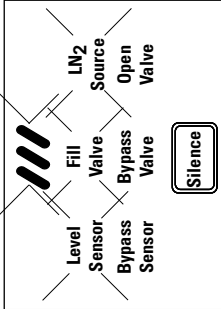
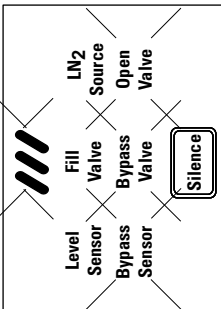
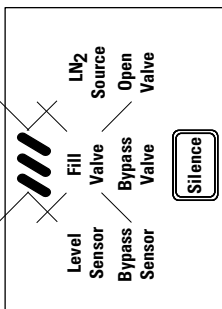
DIP Switch Settings	
No By-pass	With By-pass
1. Up	1. Down
2. Down	2. Up
3. Up	3. Up

Access the bar graph circuit board (right) by lifting off the plastic frame surrounding the front of the panel and removing the Phillips screws.

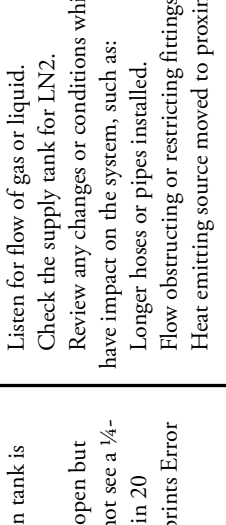
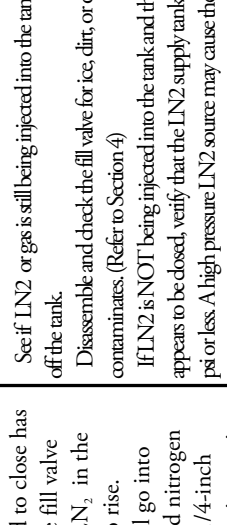
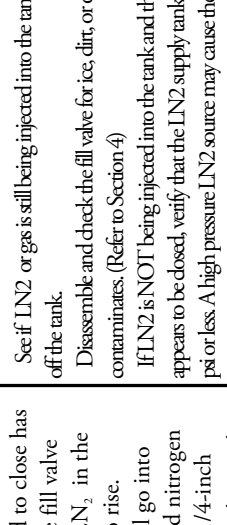
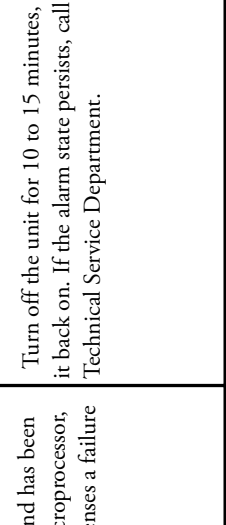


**Figure 3-6.** Bar Graph Circuit Board

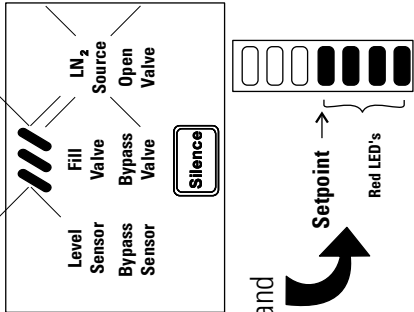
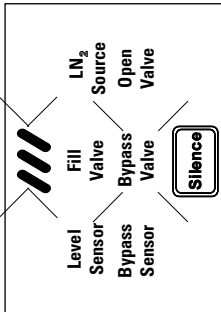
**The audible alarm can only be silenced with the key switch in the Programming Access position.  
Return the key switch to the Lock position after silence.  
Alarms do not ring back except where noted.**

Front Panel Alarm	Alarm Description and System Response	Probable Cause	Corrective Action	Printer Error Code
	<p>Top three warning lamps flash. The alarm bars light. The audible alarm sounds. The Fill and Bypass valves close. Remote alarm contacts activate immediately. Printer prints Error Code 1.</p>	<p>Bad AC input error.</p>	<p>Turn the unit off for five to ten minutes and turn it back on. If alarm condition persists, call the Technical Services Department.</p>	<p>1</p>
	<p>Bottom three warning lamps flash and the alarm bars light. The audible alarm sounds. Fill and Bypass valves close. Remote alarm contacts activate immediately. Printer prints Error Code 2.</p>	<p>Analog to digital power converter error.</p>	<p>Turn the unit off for five to ten minutes and turn it back on. If alarm condition persists, call the Technical Services Department.</p>	<p>2</p>
	<p>Fill Valve warning lamp and the alarm bars light. The audible alarm sounds. Fill and Bypass valves close. The remote alarm contacts set to activate in 30 minutes. Printer prints Error Code 3.</p>	<p>System does not detect that the valve is connected or operating. Valve coil may be open. Wires may be cut or broken. Electrical connector may be unplugged from the valve or from the circuit board (Figures 3-2 and 3-4).</p>	<p>Check connectors on the valve and on the circuit board. Check all wires for cuts or breaks. Check the electrical continuity of the fill valve coil. Repair or replace as necessary.</p>	<p>3</p> <p style="text-align: right; font-size: small;">alarm7a.cdr</p>

**The audible alarm can only be silenced with the key switch in the Programming Access Position.  
Return the key switch to the Lock position after silence.  
Alarms do not ring back except where noted.**

Front Panel Alarm	Alarm Description / System Response	Probable Cause	Corrective Action	Printer Error Code
 <p>and</p> 	<p>LN2 Source warning lamp and the alarm bars light, indicating that no liquid nitrogen is flowing to the unit. Fill and Bypass valves close. The audible alarm sounds. The remote alarm contacts set to activate in 30 minutes. This alarm will ring back in 30 minutes if the alarm condition is not corrected.</p>	<p>Liquid Nitrogen tank is empty. Bypass valve is open but the system does not see a 1/4-inch rise of LN<sub>2</sub> in 20 minutes Printer prints Error Code 4.</p>	<p>Listen for flow of gas or liquid. Check the supply tank for LN<sub>2</sub>. Review any changes or conditions which may have impact on the system, such as: Longer hoses or pipes installed. Flow obstructing or restricting fittings installed. Heat emitting source moved to proximity of system. Note: An LN<sub>2</sub> Source Alarm is normally a LN<sub>2</sub> supply problem and not a fault of the Cryo Plus Storage System. Refer to Section 1.2 of this manual and make sure that the unit is receiving <i>liquid</i> nitrogen and not just nitrogen <i>gas</i>.</p>	<p>4</p>
	<p>Open Valve warning lamp and the alarm bars light. The audible alarm sounds. Fill and Bypass valves attempt to close. The Remote alarm contacts activate immediately Alarm system resets if condition corrects. Printer prints Error Code 5.</p>	<p>The command to close has been given to the fill valve but the level of LN<sub>2</sub> in the unit continues to rise. The system will go into alarm if the liquid nitrogen rises more than 1/4-inch above the high limit setpoint within 3-10 minutes after the fill valve closes.</p>	<p>See if LN<sub>2</sub> or gas is still being injected into the tank. If so, turn off the tank. Disassemble and check the fill valve for ice, dirt, or other contaminants. (Refer to Section 4) If LN<sub>2</sub> is NOT being injected into the tank and the fill valve appears to be closed, verify that the LN<sub>2</sub> supply tank pressure is 22 psi or less. A high pressure LN<sub>2</sub> source may cause the unit to overflow past the high level set point. Note: This condition can result when several storage racks are placed into the container; raising the level of the liquid nitrogen above the High Level set point, within 10 minutes of a fill.</p>	<p>5</p>
	<p>Open Valve warning lamp flashes and the alarm bars light. The audible alarm sounds. Fill and Bypass valves attempt to close. The Remote alarm contacts set to activate in 30 minutes. Printer prints Error Code 5.</p>	<p>The fill command has been issued by the microprocessor, but the system senses a failure in the fill circuit.</p>	<p>Turn off the unit for 10 to 15 minutes, then turn it back on. If the alarm state persists, call the Technical Service Department.</p>	<p>5</p> <p style="text-align: right; font-size: small;">alarm.ta.cdr</p>

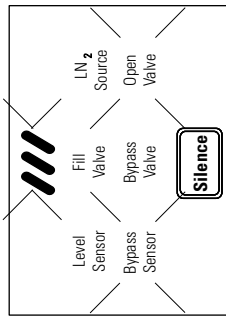
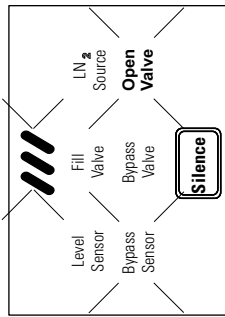
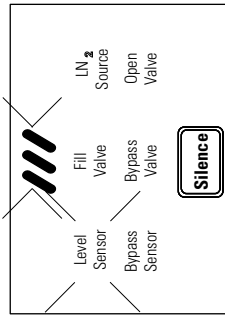
**The audible alarm can only be silenced with the key switch in the Programming Access Position.  
Return the key switch to the Lock position after silence.  
Alarms do not ring back except where noted.**

Front Panel Alarm	Alarm Description and System Response	Probable Cause	Corrective Action	Printer Error Code
 <p>Level Sensor Bypass Sensor Fill Valve Bypass Valve LN<sub>2</sub> Source Open Valve Silence</p> <p>and</p> <p>Setpoint → Red LED's</p>	<p>LN<sub>2</sub> Source warning lamp and the alarm bars light, indicating that no liquid nitrogen is flowing to the unit. Fill and Bypass valves close. The audible alarm sounds. The remote alarm contacts set to activate in 30 minutes. This alarm will ring back in 30 minutes if the alarm condition is not corrected.</p>	<p>LN<sub>2</sub> level does not reach the setpoint in 60 minutes. Printer prints Error Code 6.  The Bypass Sensor does not see the supply line temp drop below -130°C in 60 minutes. Printer prints Error Code 8.</p>	<p>Listen for flow of gas or liquid. Check the supply tank for LN<sub>2</sub>. Review any changes or conditions which may have impact on the system, such as: Longer hoses or pipes installed. Flow obstructing or restricting fittings installed. Heat emitting source moved to proximity of system. Note: An LN<sub>2</sub> Source Alarm is normally a LN<sub>2</sub> supply problem and not a fault of the Cryo Plus Storage System. Refer to Section 1.2 of this manual and make sure that the unit is receiving <i>liquid</i> nitrogen and not just nitrogen <i>gas</i>.</p>	<p>6</p> <p>8</p>
 <p>Level Sensor Bypass Sensor Fill Valve Bypass Valve LN<sub>2</sub> Source Open Valve Silence</p>	<p>Bypass Valve warning lamp and the alarm bars light. The audible alarm sounds. The Remote alarm contacts set to activate in 30 minutes. Bypass valve closes. Printer prints Error Code 7.</p>	<p>The system does not detect that the valve is connected or operating. Valve coil may be open. Wires may be cut or broken. The electrical connector may be unplugged from the valve or from the circuit board (Figures 3-2 and 3-4).</p>	<p>Check the connectors on the valve and on the circuit board. (Figures 3-2 and 3-4) Check all wiring for cuts or breaks. Check the electrical continuity of the valve coil. If the alarm state cannot be corrected, call the Technical Services Department.</p>	<p>7</p> <p>alarm1 a.cdr</p>

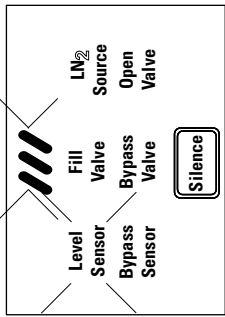
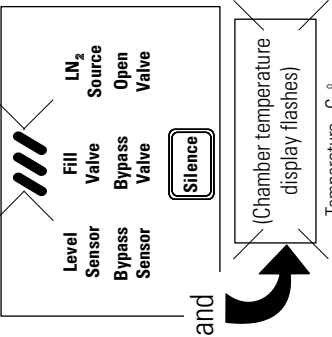
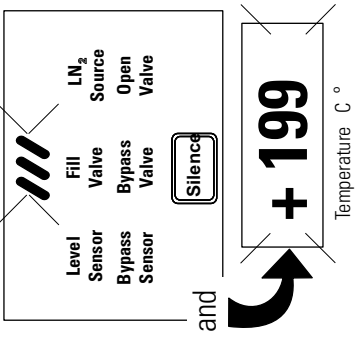
**Section 3**

Troubleshooting the Alarms

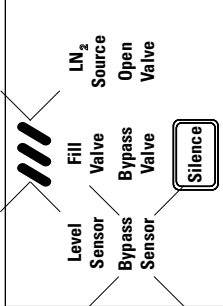
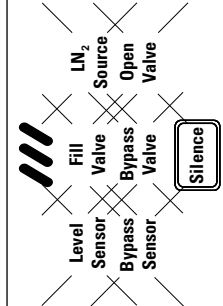
The Alarm can only be silenced with the key switch in the Programming Access position.  
 Return the key switch to the Lock position after silence.  
 Alarms do not ring back except where noted.

Front Panel Alarm	<b>Alarm Description and System Response</b>	Probable Cause	Corrective Action	Printer Error Code
	<p>Bypass Sensor and Open Valve warning lamps flash and the alarm bars light. The audible alarm sounds.                      Fill and Bypass valves close.                      Remote alarm contacts set to activate in 30 minutes.                      Printer prints Error Code 9.</p>	<p>Fill command has been issued by the microprocessor, but the system senses a failure in the bypass circuit.</p>	<p>Turn off the unit for 10 to 15 minutes, then turn it back on. If the alarm state recurs, call Technical Services Department.</p>	<p>9</p>
	<p>Bypass Sensor and Open Valve warning lamps and the alarm bars light. Audible alarm sounds.                      Fill and Bypass valves close.                      Remote alarm contacts activate immediately.                      Printer prints Error Code 9.</p>	<p>Dirt or ice in the fill valve.</p>	<p>If liquid nitrogen runs out of the bypass valve, shut off the LN2 supply source, then remove and refurbish or replace the fill valve.</p>	
	<p>Level Sensor warning lamp and the alarm bars light. The audible alarm sounds.                      Fill and Bypass valves close.                      Remote alarm contacts set to activate in 30 minutes.                      Printer prints Error Code 10.</p>	<p>Level sensor or pressure transducer malfunction.</p>	<p>Pressure transducer port in bottom of tank may be clogged or blocked. Vinyl tubing to the circuit board leaks, may be kinked or cracked, or has come off the fitting.                      If alarm persists, call Technical Services Department.                      (The pressure transducer is not a field-service item)  <b>Caution!</b> Do NOT blow into the vinyl tubing or apply pressure greater than 1 PSI.</p>	<p>9</p> <p style="text-align: right; font-size: small;">alarmfa.cdr</p>

**The Alarm can only be silenced with the key switch in the Programming Access position.  
Return the key switch to the Lock position after silence.  
Alarms do not ring back except where noted.**

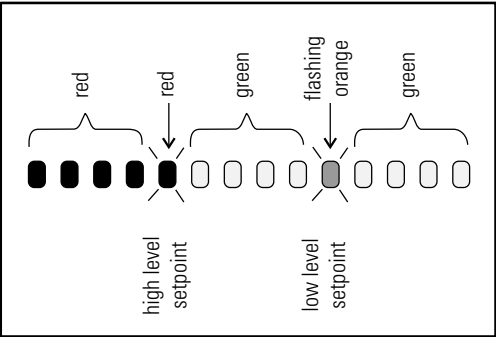
Front Panel Alarm	Alarm Description / System Response	Probable Cause	Corrective Action	Printer Error Code
	<p>Level Sensor warning lamp flashes and the alarm bars light. The audible alarm sounds. Fill and Bypass valves close. Remote alarm contacts set to activate in 30 minutes. Printer prints Error Code 10.</p>	<p>Level sensor or pressure transducer out of calibration.</p>	<p>Pressure transducer port in bottom of tank may be clogged or blocked. Vinyl tubing to the circuit board may leak, be kinked or cracked, or has become disconnected from the fitting. If alarm persists, call Technical Services Department. (The pressure transducer is not a field-service item.) <b>Caution!</b> Do NOT blow into the vinyl tubing or apply pressure greater than 1 PSI.</p>	<p>10</p>
	<p>High temperature alarm: The alarm bars light and the temperature display flashes the thermocouple temperature. The audible alarm sounds. Remote alarm contacts set to activate in 30 minutes. Alarm system resets if condition corrects. Printer prints Error Code 11.</p>	<p>The thermocouple temperature is warmer than the high temperature setpoint. The lid has been open too long. An excessive heat load (warm product) has been placed into the chamber.</p>	<p>Make sure the temperature sleeve is properly installed to lower the chamber temperature. Raise the high temperature setpoint. The temperature is measured using a T-type thermocouple with an accuracy of ±3C for 196C. The temperature gradient within the tank is dependent upon changes to the LN2 which affects its stabilization (fill, evaporation, introduction of warmer product, etc.). The higher the level of LN2, the colder the unit will be. Make sure the high temperature alarm set point is not lower than the height of the LN2 is capable of maintaining.</p>	<p>11</p>
	<p>The alarm bars light and the temperature display flashes. The display shows +199. The audible alarm sounds. Remote alarm contacts set to activate in 30 minutes. Alarm system resets if condition corrects. Printer prints Error Code 12.</p>	<p>Temperature probe wires cut or broken. The Temperature probe connector is unplugged from the circuit board. (Figure 3-2) Probe circuit failure.</p>	<p>Replace or repair the temperature probe wires. Verify the circuit board connector.</p>	<p>12</p> <p style="text-align: right; font-size: small;">alarm5a.cdr</p>

**The audible alarm can only be silenced with the key switch in the Programming Access position.  
 Return the key switch to the Lock position after silence.  
 Alarms do not ring back except where noted.**

Front Panel Alarm	Alarm Description and System Response	Probable Cause	Corrective Action	Printer Error Code
	<p>Bypass Sensor warning lamp and the alarm bars light. The audible alarm sounds.</p> <p>The Remote alarm contacts set to activate in 30 minutes.</p> <p>The Alarm system resets if the condition corrects.</p> <p>When the system recognizes a bypass circuit failure, it will not open the Bypass Valve and continue the fill without the bypass active.</p>	<p>The system does not detect that the sensor is connected or operating.</p> <p>Wires may be cut or broken.</p> <p>The electrical connector may be unplugged from the circuit board (Figure 3-2).</p>	<p>Check all wiring for cuts or breaks.</p> <p>Verify that the sensor connector is secure on the circuit board (Figure 3-2).</p> <p>The alarm is cleared by turning the key switch to Full Access and back to Lock. The system will go into the alarm state the next time an LN2 fill command is issued if the bypass fault is not corrected.</p> <p>If the alarm state cannot be corrected, call the Technical Services Department.</p>	<p>13</p>
	<p>All warning lamps light. System will not operate.</p> <p>Printer prints Error Code 14.</p>	<p>The microprocessor sees a circuit board fault on initial power up and the sum check is wrong.</p>	<p>Turn the system off for five to ten minutes, then turn it back on. The system should reset by restoring default limits.</p> <p>If system does not self-correct, call the Technical Services Department.</p>	<p>14</p>

alarm2a.cdr

The Alarm can only be silenced with the key switch in the Programming Access position.  
 Return the key switch to the Lock position after silence.  
 Alarms do not ring back except where noted.

Front Panel Alarm	Alarm Description and System Response	Probable Cause	Corrective Action	Printer Error Code
	<p>The liquid nitrogen level is one inch or more above the high level set point.                  The remote contacts set to activate in 30 minutes.                  The alarm system resets if the alarm condition corrects.                  Printer prints Error 15.</p>	<p>The liquid nitrogen level is one inch or more above the high level set point.</p>	<p>Move the high level set-point to the current LN<sub>2</sub> level.                  (The set-point can be changed back after the LN<sub>2</sub> has evaporated to the desired level.)</p>	<p>15</p> <p style="text-align: right; font-size: small;">alarm5a.cdr</p>





## Section 4 Maintenance

Valve maintenance is described below.

**Warning** These procedures must be performed by qualified service technicians. ▲

### Operation

Normally closed: Valve is closed when solenoid is de-energized, valve is open when solenoid is energized.

### Positioning/Mounting

The valve is designed to perform properly when mounted in any position. However, for optimum life and performance, the solenoid should be mounted upright to reduce the possibility of foreign matter accumulating in the core tube area.

### Maintenance

**Warning** Turn OFF electrical power supply and de-pressurize valve before making repairs. It is not necessary to remove valve from pipe line for repairs. ▲

### Cleaning

A periodic cleaning of all solenoid valves(s) is desirable. The time between cleanings will vary, depending upon media and service conditions. Generally, if the voltage to the coil is correct, sluggish valve operation, excessive noise, or leakage will indicate that cleaning is required.

### Valve Disassembly and Reassembly

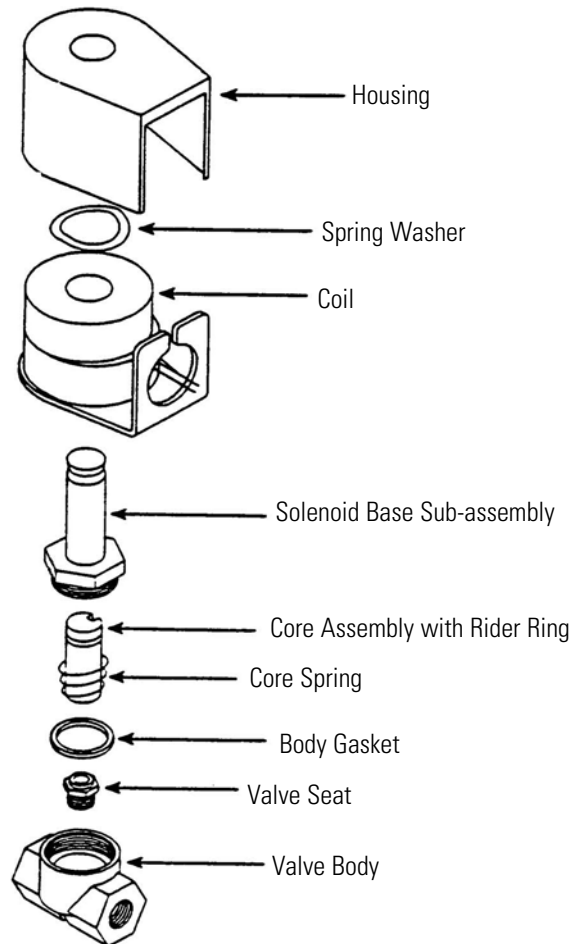
De-pressurize valve and turn OFF electrical power supply. Proceed in the following manner:

1. Remove retaining clip and slide entire solenoid enclosure from solenoid base sub-assembly.

**Caution** When metal retaining clip disengages, it springs upward. ▲

2. Unscrew solenoid base sub-assembly and remove body gasket, core assembly with rider ring and core spring attached.

3. Clean and assemble in reverse order of disassembly, paying careful attention to exploded view provided (Figure 4-1) for identification and placement of parts.



**Figure 4-1.** Exploded View of Valve

**Note** Use thread sealant, not Teflon tape. Tape could get into valve. ▲

4. After maintenance, operate the valve a few times to ensure proper opening and closing.

## General Cleaning

Protective clothing and gloves should be worn whenever cleaning the inside of this unit. Follow established laboratory procedures. Allow the interior of the unit to warm to ambient and use an appropriate germicide.

### Freezing chamber

The interior of the CryoPlus unit is made of high quality stainless steel and should not be cleaned with any cleanser containing chlorine.

### Exterior cabinet

Wash the outside of the cabinet with a mild detergent.

## Defrosting the Storage Tank

To defrost the storage tank, remove the product and LN<sub>2</sub> from the tank. Allow the tank to warm at room temperature.

**Caution** Do not attempt to speed up LN<sub>2</sub> evaporation, or frost removal, by blowing direct heat. Avoid using a heater or blowing compressed air into the storage tank. ▲

## Defrosting the Vent Port

To defrost the vent port, open the lid and allow to warm at room temperature. See Caution above.

The opening of the storage container can be loosely covered while the vent port thaws.

After the port has thawed, remove all moisture from the vent port area before returning the tank to service.

## Gas Springs

The gas springs should be checked periodically, and ideally every six months. The opening force, as measured from the front lip from a closed position, should be below 100 N (22.5 lbf) maximum. If the force is above this value, the gas springs should be replaced. If a force measurement is not possible, the gas springs should be replaced every two years.



## Section 5 Specifications

**Table 5-1.** Specifications

Series	CryoPlus 1	CryoPlus 2	CryoPlus 3	CryoPlus 4
LN2 capacity (liters)	90	200	340	552
Static evaporation rate (liters/day)*	3	5	8	10
Static Holding Time (days)	30	40	42.5	55
Exterior Height	41.0" (104.1 cm)	41.0" (104.1 cm)	41.0" (104.1 cm)	47.0" (119.4 cm)***
Exterior W x D	21.5"W x 26.0" F-B** (54.6 cm x 66.0 cm)	28.5"W x 34.0" F-B** (72.4 cm x 86.4 cm)	34.5"W x 41.5" F-B** (87.6 cm x 105.4 cm)	43.5"W x 50.0" F-B** (110.5 cm x 127.0 cm)
Usable Interior Height	27.5" (69.9 cm)	27.5" (69.9 cm)	27.5" (69.9 cm)	29.5" (74.9 cm)
Usable Interior Diameter	16.0" (40.6 cm)	24.0" (61.0 cm)	31.0" (78.7 cm)	39.5" (100.3 cm)
Electrical	100 - 120 VAC, 1 PH, 50/60 Hz, 0.8 FLA (Operating Range 90-132V) 200 - 230 VAC, 1 PH, 50/60 Hz, 0.5 FLA (Operating Range 180-253V)			
Utility Connections	1/2" 45° Flare 4-foot hose	1/2" 45° Flare 6-foot hose	1/2" 45° Flare 6-foot hose	1/2" 45° Flare 6-foot hose
Weight Empty	194.0 lbs. (88.0 kg)	325.0 lbs. (147.4 kg)	416.0 lbs. (188.7 kg)	680.0 lbs. (308.4 kg)
Weight Full	354.0 lbs.(160.6 kg)	680.0 lbs. (308.4 kg)	1021.0 lbs.(463.1 kg)	1620.0 lbs. (734.8 kg)
Shipping Weight	260.0 lbs. (117.9 kg)	400.0 lbs. (181.4 kg)	540.0 lbs. (244.9 kg)	892.0 lbs. (404.6 kg)

Continuing research and improvements may result in specification changes at any time.

\* Static evaporation rates are based on new container performance, no product load, styrofoam plug/lid, and no lid openings. Actual working performance may vary with individual applications, ambient conditions, and/or scale accuracy; excludes supply tank evaporation.

\*\* Add 5.0" (12.7 cm) for utilities and lid opening

\*\*\* 93.5" (237.5 cm) total unit height of CryoPlus 4 with lid open



## Section 6 Parts List

**Table 6-1.** Parts List

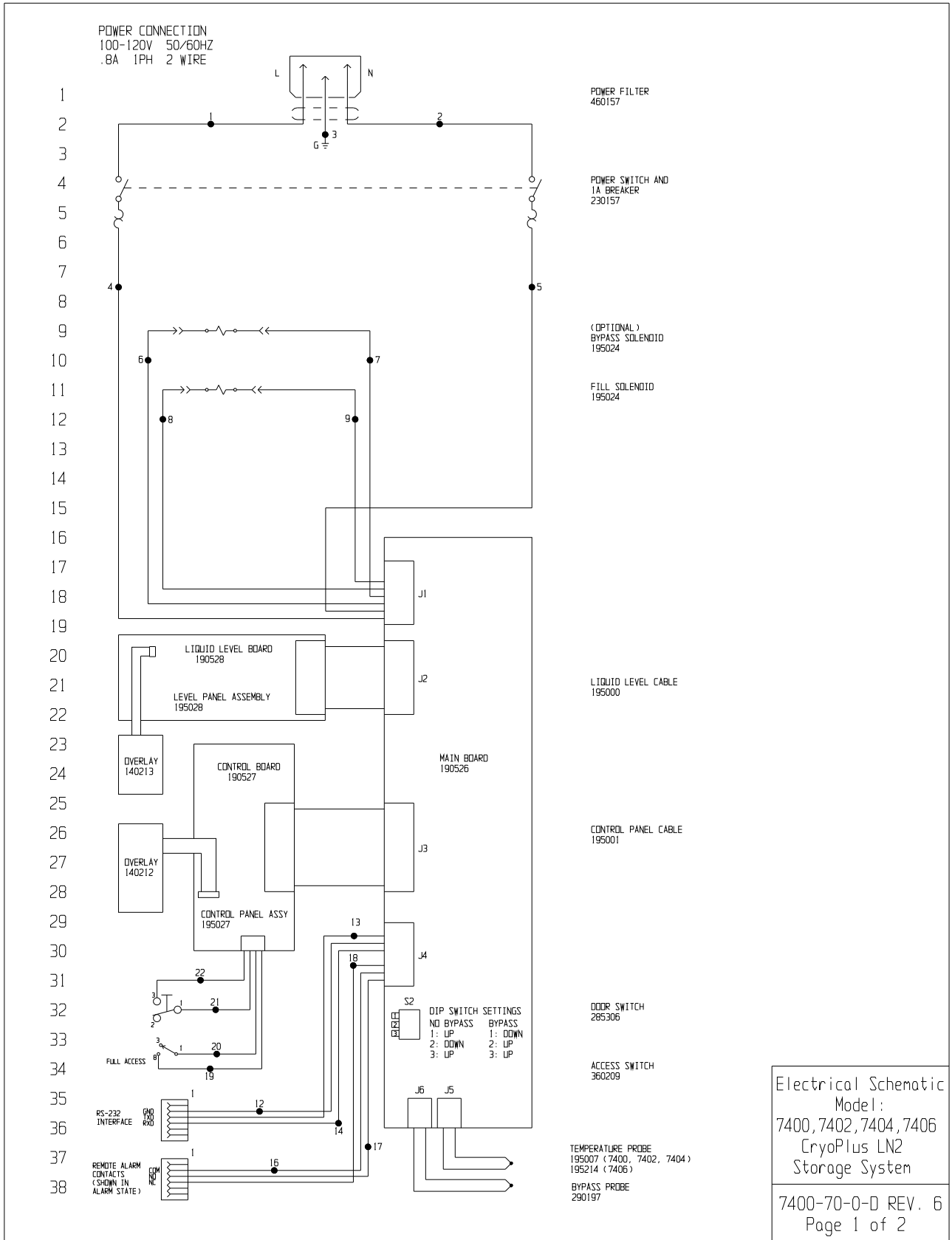
Stock No.	Description	Models			
		7400/7401	7402/7403	7404/7405	7406/7407
103067	Tank trim gasket	5-foot	7-foot	8.5-foot	11-foot
107406	Lid seal gasket	5-foot	7-foot	8.5-foot	11-foot
120054	Dual wheel caster	4	4	4	
120059	Caster				4
122010	Lid tumbler lock	1	1	1	1
129063	Lid pneumatic spring	1			
129064	Lid pneumatic spring		2		
129065	Lid pneumatic spring			2	
129066	Lid pneumatic spring (210 lbs.)				2
190526	CryoPlus microprocessor board	1	1	1	1
195000	Ribbon cable - level to main	1	1	1	1
195721	Ribbon cable - control board to main	1	1	1	1
195002	CryoPlus main wiring harness	1	1	1	1
195007	CryoPlus temperature probe	1	1	1	
195214	CryoPlus temperature probe				1
195024	120V valve assy. 7400,7402, 7404, 7406	1	1	1	1
195025	220V valve assy. 7401,7403, 7405, 7407	1	1	1	1
400142	RJ-11 output cable	1	1	1	1
195027	CryoPlus control panel assembly	1	1	1	1
195028	CryoPlus level panel assembly	1	1	1	1



**Section 6**  
Parts List

**Table 6-1.** Parts List (continued)

Stock No.	Description	Models			
		7400/7401	7402/7403	7404/7405	7406/7407
251008	Pressure relief valve 1/4" MPT	1	1	1	1
990027	Magnetic lid gasket	1			
990028	Magnetic lid gasket		1		
990029	Magnetic lid gasket			1	
990031	Magnetic lid gasket				1
180143	LN <sub>2</sub> dip measuring ruler	1	1	1	1
4000400	4 foot transfer hose	1			
4000401	6 foot transfer hose		1	1	1
195884	Lid closing strap	1	1	1	1
123037	Lid magnet	1	1	1	1
4000412	T/C Probe Tubing Replacement Kit (12")	1	1	1	
4000413	T/C Probe Tubing Replacement Kit (15")				1
400142	RJ-11 Cable				1



**Section 7**  
Electrical Schematics

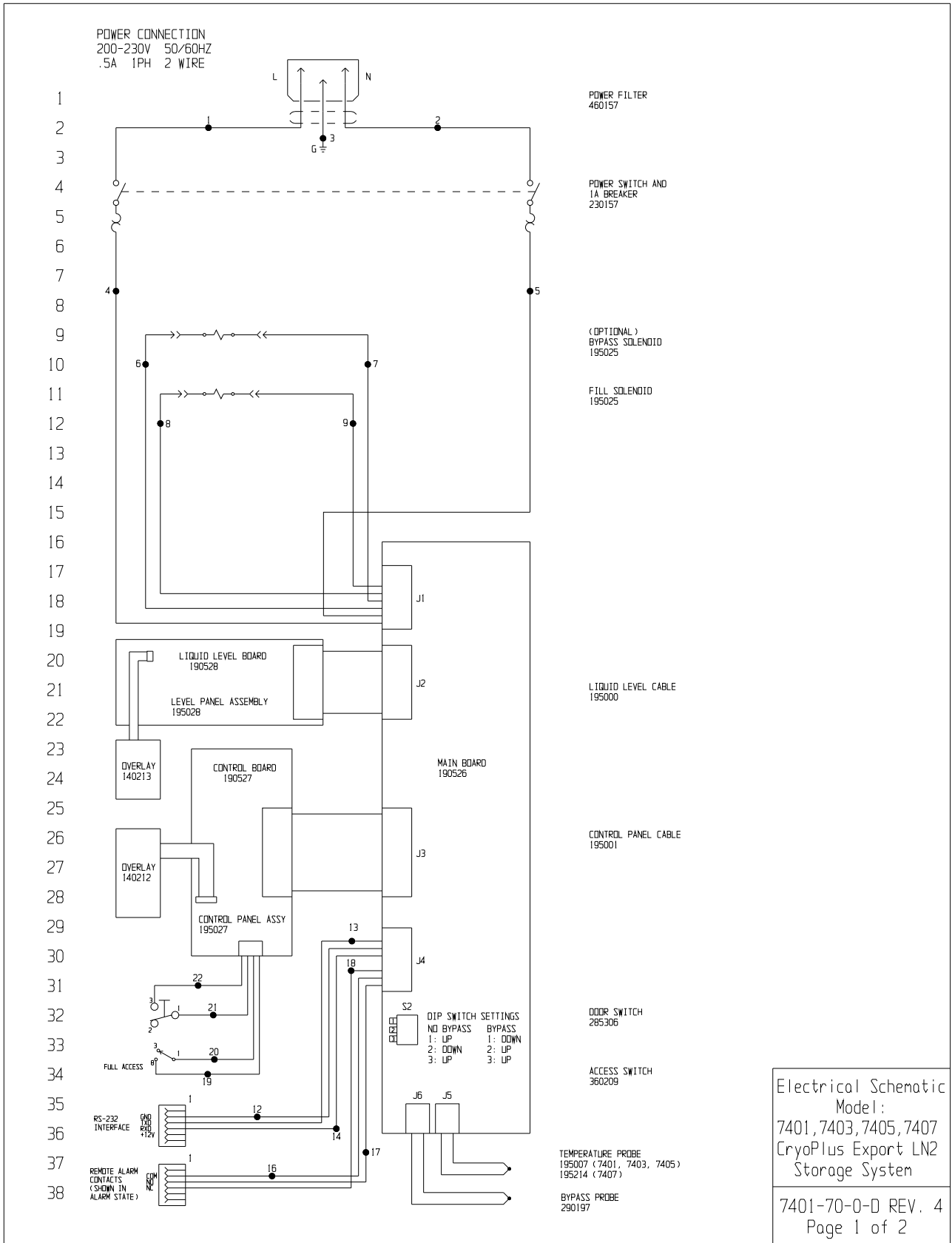
77  
78  
79  
80  
81  
82  
83  
84  
85  
86  
87  
88  
89  
90  
91  
92  
93  
94  
95  
96  
97  
98  
99  
100  
101  
102  
103  
104  
105  
106  
107

WIRE REFERENCE CHART

WIRE #	GAUGE	COLOR
1	18	BRN
2	18	BLU
3	18	GRN/YEL
4	18	BLK
5	18	WHT
6	22/3	BLK
7	22/3	RED
8	22/3	BLK
9	22/3	WHT
10		
11		
12	24/7	GRN
13	24/7	ORG
14	24/7	BLU
15		
16	24/7	BLK
17	24/7	RED
18	24/7	WHT
19	22	PUR
20	22	ORG
21	22	ORG
22	22	YEL

<b>NOTES:</b> <input checked="" type="checkbox"/> Denotes Terminal Strip Connection Last Relay Number Last Terminal Number 22 Last Wire Number	Parts List Reference Number <input type="checkbox"/> Assembly <input type="checkbox"/> Panel <input type="checkbox"/> Refrigeration <input type="checkbox"/> Wiring	CUSTOMER APPROVAL/REFERENCE APPROVED BY _____ APPROVING FIRM _____ DATE OF APPROVAL _____	
		THIS DECLARATION CONTAINS PROPRIETARY INFORMATION AND SUCH INFORMATION IS NOT TO BE DISCLOSED TO OTHERS FOR ANY PURPOSE NOR USED FOR MANUFACTURING PURPOSES WITHOUT WRITTEN PERMISSION FROM THERMO FISHER SCIENTIFIC	
		6 FR-2440 12-12-13 GSW KDG CCS REMOVED TANK SWITCHER OUTLET 5 FR-2371 6-15-12 GSW SAG MSB DELETED WIRE 15 4 SI-1094 9-21-11 GSW MLS LDN REVISED PER ECR#26806 3 FR-1148 08-11-97 AFC PDK LDN CORRECT CONTROL BOARD NUMBER 2 FR-1093 02-20-97 MAB PDK LDN CORRECT WIRE COLORS	
		1 FR-1010 08-21-96 WCW RGM WCW REVISED SOLENOID NUMBER 0 N/A 10-26-95 AT AT WCW RELEASED FOR PRODUCTION	
		REV ECR NO. DATE BY CAD/APPO DESCRIPTION OF REVISION DATE 10-26-95 DWN AT CAD AT APPD WCW SCALE NONE	
		CUSTOMER _____ JOB TITLE CRYOPLUS (7400, 7402, 7404, 7406) DWG TITLE ELECTRICAL SCHEMATIC	
		LOCATION FREEZERS JOB NUMBER _____ DRAWING NUMBER 7400-70-0-D	

Electrical Schematic  
 Model:  
 7400, 7402, 7404, 7406  
 CryoPlus LN2  
 Storage System  
 7400-70-0-D REV. 6  
 Page 2 of 2





## **THERMO FISHER SCIENTIFIC STANDARD PRODUCT WARRANTY (LN<sub>2</sub> Vacuum)**

The Warranty Period starts two weeks from the date your equipment is shipped from our facility. This allows for shipping time so the warranty will go into effect at approximately the same time your equipment is delivered. The warranty protection extends to any subsequent owner during the first year warranty period.

During the first year, component parts proven to be non-conforming in materials or workmanship will be repaired or replaced at Thermo's expense, labor included. *LN<sub>2</sub> Vacuum Integrity is covered for two years.* Installation and calibration are not covered by this warranty agreement. The Technical Services Department must be contacted for warranty determination and direction prior to performance of any repairs. Expendable items, glass, filters and gaskets are excluded from this warranty.

Replacement or repair of components parts or equipment under this warranty shall not extend the warranty to either the equipment or to the component part beyond the original warranty period. The Technical Services Department must give prior approval for return of any components or equipment. At Thermo's option, all non-conforming parts must be returned to Thermo postage paid and replacement parts are shipped FOB destination.

**THIS WARRANTY IS EXCLUSIVE AND IN LIEU OF ALL OTHER WARRANTIES, WHETHER WRITTEN, ORAL OR IMPLIED. NO WARRANTIES OF MERCHANTABILITY OR FITNESS FOR A PARTICULAR PURPOSE SHALL APPLY.** Thermo shall not be liable for any indirect or consequential damages including, without limitation, damages relating to lost profits or loss of products.

Your local Thermo Sales Office is ready to help with comprehensive site preparation information before your equipment arrives. Printed instruction manuals carefully detail equipment installation, operation and preventive maintenance.

If equipment service is required, please call your Technical Services Department at 1-800-438-4851 (USA and Canada) or 1-740-373-4763. We're ready to answer your questions on equipment warranty, operation, maintenance, service and special application. Outside the USA, contact your local distributor for warranty information.



Rev. 4 4/09

## **THERMO FISHER SCIENTIFIC INTERNATIONAL DEALER WARRANTY**

The Warranty Period starts two months from the date your equipment is shipped from our facility. This allows for shipping time so the warranty will go into effect at approximately the same time your equipment is delivered. The warranty protection extends to any subsequent owner during the first year warranty period. Dealers who stock our equipment are allowed an additional six months for delivery and installation, provided the warranty card is completed and returned to the Technical Services Department.

During the first year, component parts proven to be non-conforming in materials or workmanship will be repaired or replaced at Thermo's expense, labor excluded. Installation and calibration are not covered by this warranty agreement. The Technical Services Department must be contacted for warranty determination and direction prior to performance of any repairs. Expendable items, glass, filters, reagents, tubing, and gaskets are excluded from this warranty.

Replacement or repair of components parts or equipment under this warranty shall not extend the warranty to either the equipment or to the component part beyond the original warranty period. The Technical Services Department must give prior approval for return of any components or equipment. At Thermo's option, all non-conforming parts must be returned to Thermo postage paid and replacement parts are shipped FOB destination.

**THIS WARRANTY IS EXCLUSIVE AND IN LIEU OF ALL OTHER WARRANTIES, WHETHER WRITTEN, ORAL OR IMPLIED. NO WARRANTIES OF MERCHANTABILITY OR FITNESS FOR A PARTICULAR PURPOSE SHALL APPLY.** Thermo shall not be liable for any indirect or consequential damages including, without limitation, damages relating to lost profits or loss of products.

Your local Thermo Sales Office is ready to help with comprehensive site preparation information before your equipment arrives. Printed instruction manuals carefully detail equipment installation, operation and preventive maintenance.

Contact your local distributor for warranty information. We're ready to answer your questions on equipment warranty, operation, maintenance, service and special application.



Rev. 4 2/09

## Handling Liquid Nitrogen

**Warning** Contact of liquid nitrogen or cold gas with the skin or eyes may cause serious freezing (frostbite) injury. ▲

Handle liquid nitrogen carefully.

The extremely low temperature can freeze human flesh very rapidly. When spilled on a surface, the liquid tends to cover it completely and intimately, cooling a large area. The gas issuing from the liquid is also extremely cold. Delicate tissue, such as that of the eyes, can be damaged by an exposure to the cold gas which would be too brief to affect the skin of the hands or face.

Never allow any unprotected part of your body to touch objects cooled by liquid nitrogen.

Such objects may stick fast to the skin and tear the flesh when you attempt to free yourself. Use tongs to withdraw objects immersed in the liquid, and handle the object carefully.

Wear protective clothing.

Protect your eyes with a face shield or safety goggles (safety glasses without side shields do not give adequate protection). Always wear gloves when handling anything that is, or may have been, in immediate contact with liquid nitrogen. Insulated gloves are recommended, but heavy leather gloves may also be used. The gloves should fit loosely, so that they can be thrown off quickly if liquid should splash into them. When handling liquid in open containers, it is advisable to wear high-top shoes. Trousers (which should be cuffless if possible) should be worn outside the shoes.

## Introduction

The safe handling and use of liquid nitrogen in cryogenic refrigerators and dewar flasks is largely a matter of knowing the potential hazards and using common-sense procedures based on that knowledge. There are two important properties of liquid nitrogen that present potential hazards:

1. It is extremely cold. At atmospheric pressure, liquid nitrogen boils at -320° F (-196° C).
2. Very small amounts of liquid vaporize into large amounts of gas. One liter of liquid nitrogen becomes 24.6 cu. ft. (0.7 m<sup>3</sup>) of gas.



The safety precautions in this manual must be followed to avoid potential injury or damage which could result from these two characteristics. Do not attempt to handle liquid nitrogen until you read and fully understand the potential hazards, their consequences, and the related safety precautions. Keep this booklet handy for ready reference and review.

**Note** Because argon is an inert gas whose physical properties are very similar to those of nitrogen, the precautions and safe practices for the handling and use of liquid argon are the same as those for liquid nitrogen. ▲

#### **Use containers designed for low temperature liquids.**

Cryogenic containers are specifically designed and made of materials that can withstand the rapid changes and extreme temperature differences encountered in working with liquid nitrogen. Even these special containers should be filled SLOWLY to minimize the internal stresses that occur when any material is cooled. Excessive internal stresses can damage the container.

**Do not cover or plug the entrance opening of any liquid nitrogen refrigerator or dewar. Do not use any stopper or other device that would interfere with venting of gas.**

These cryogenic liquid containers are generally designed to operate with little or no internal pressure. Inadequate venting can result in excessive gas pressure which could damage or burst the container. Use only the loose-fitting necktube core supplied or one of the approved accessories for closing the necktube. Check the unit periodically to be sure that venting is not restricted by accumulated ice or frost.

#### **Use proper transfer equipment.**

Use a phase separator or special filling funnel to prevent splashing and spilling when transferring liquid nitrogen into or from a dewar or refrigerator. The top of the funnel should be partly covered to reduce splashing. Use only small, easily-handled dewars for pouring liquid. For the larger, heavier containers, use a cryogenic liquid withdrawal device to transfer liquid from one container to another. Be sure to follow instructions supplied with the withdrawal device. When liquid cylinders or other large storage containers are used for filling, follow the instructions supplied with those units and their accessories.

#### **Do not overfill containers.**

Filling above the bottom of the necktube (or specified maximum level) can result in overflow and spillage of liquid when the necktube core or cover is placed in the opening.

**Never use hollow rods or tubes as dipsticks.**

When a warm tube is inserted into liquid nitrogen, liquid will spout from the top of the tube due to gasification and rapid expansion of liquid inside the tube.

**Warning** Nitrogen gas can cause suffocation without warning! ▲

**Store and use liquid nitrogen only in a well-ventilated place.**

As the liquid evaporates, the resulting gas tends to displace the normal air from the area. In closed areas, excessive amounts of nitrogen gas reduce the concentration of oxygen and can result in asphyxiation. Because nitrogen gas is colorless, odorless and tasteless, it cannot be detected by the human senses and will be breathed as if it were air. Breathing an atmosphere that contains less than 18% oxygen can cause dizziness and quickly result in unconsciousness and death.

**Note** The cloudy vapor that appears when liquid nitrogen is exposed to the air is condensed moisture; not the gas itself. The issuing gas is invisible. ▲

**Never dispose of liquid nitrogen in confined areas or places where others may enter.**

Disposal of liquid nitrogen should be done outdoors in a safe place. Pour the liquid slowly on gravel or bare earth where it can evaporate without causing damage. Do not pour the liquid on pavement.

**First Aid** If a person seems to become dizzy or loses consciousness while working with liquid nitrogen, move to a well-ventilated area immediately. If breathing has stopped, apply artificial respiration. If breathing is difficult, give oxygen. Call a physician. Keep warm and at rest.

If exposed to liquid or cold gas, restore tissue to normal body temperature (98.6°F) as rapidly as possible, followed by protection of the injured tissue from further damage and infection.

Remove or loosen clothing that may constrict blood circulation to the frozen area. Call a physician. Rapid warming of the affected part is best achieved by using water at 108°F. Under no circumstance should the water be over 112°F, nor should the frozen part be rubbed either before or after rewarming. The patient should neither smoke nor drink alcohol.



Thermo Fisher Scientific  
401 Millcreek Road  
Marietta, Ohio 45750  
United States

[www.thermofisher.com](http://www.thermofisher.com)