

Allegra® 6 Series and Spinchron™ R Centrifuges

Instruction Manual

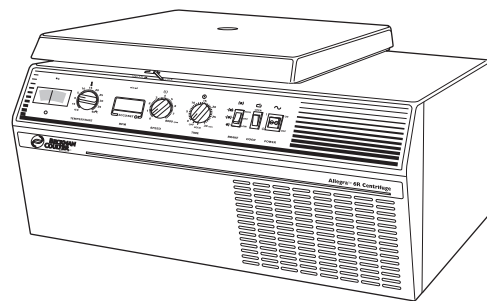

Symbol Symbol Symbole Símbolo	Simbolo 記号 符号	Title / Titel / Titre / Titolo / Titolo / 名称 / 名称
		Dangerous voltage Gefährliche elektrische Spannung Courant haute tension Voltaje peligroso Pericolo: alta tensione 危険電圧 危险电压
		Attention, consult accompanying documents Achtung! Begleitpapiere beachten! Attention, consulter les documents joints Atención, consulte los documentos adjuntos Attenzione: consultare le informazioni allegate 注意、添付資料を参照のこと 注意，请参阅附带的文件
		On (power) Ein (Netzverbindung) Marche (mise sous tension) Encendido Acceso (sotto tensione) 入（電源） 开（电源）
		Off (power) Aus (Netzverbindung) Arrêt (mise hors tension) Apagado Spento (fuori tensione) 切（電源） 关（电源）
		Protective earth (ground) Schutzleiteranschluß Liaison à la terre Puesta a tierra de protección Collegamento di protezione a terra 保護アース（接地） 保护接地
		Earth (ground) Erde Terre Tierra Scarica a terra アース（接地） 接地



SAFETY NOTICE

This safety notice summarizes information basic to the safe operation of the equipment described in this manual. The international symbol displayed above is a reminder that all safety instructions should be read and understood before installation, operation, maintenance, or repair of this centrifuge. When you see the symbol on other pages, pay special attention to the safety information presented. Observance of safety precautions will also help to avoid actions that could damage or adversely affect the performance of the centrifuge.

Safety During Installation and/or Maintenance

This centrifuge weighs 51.7 kg/114.0 lb (nonrefrigerated benchtop), 75.8 kg/167.0 lb (refrigerated benchtop), or 90.3 kg/199.0 lb (refrigerated kneewell). DO NOT attempt to lift or move it without assistance from another person.

Be sure to use the anchoring system to secure the centrifuge in place. The anchoring system is designed to reduce the possibility of injury or damage that could result from centrifuge movement in the event of a major rotor mishap.

Any servicing of this equipment that requires removal of any covers can expose parts which involve the risk of electric shock or personal injury. Make sure that the power switch is off and the centrifuge is disconnected from the main power source, and refer such servicing to qualified personnel.

Do not replace any centrifuge components with parts not specified for use on this instrument.

Electrical Safety

To reduce the risk of electrical shock, this equipment uses a three-wire electrical cord and plug to connect the centrifuge to earth-ground. To preserve this safety feature:

- Make sure that the matching wall outlet receptacle is properly wired and earth-grounded. Check that the line voltage agrees with the voltage listed on the name-rating plate affixed to the centrifuge.
- Never use a three-to-two wire plug adapter.
- Never use a two-wire extension cord or a two-wire non-grounding type of multiple-outlet receptacle strip.

Do not place containers holding liquid on or near the chamber door. If they spill, liquid may get into the centrifuge and damage electrical or mechanical components.

Safety Against Risk of Fire

Certain electrical circuits within this equipment are protected by fuses against overcurrent conditions. For continued protection against the risk of fire, replace only with the same type and rating specified.

This centrifuge is not designed for use with materials capable of developing flammable or explosive vapors. Do not centrifuge such materials (such as chloroform or ethyl alcohol) in this centrifuge nor handle or store them within the 30-cm (1-ft) area surrounding the centrifuge.

Mechanical Safety

For safe operation of the equipment, observe the following:

- Use only the rotors and accessories designed for use in this centrifuge.
- Before starting the centrifuge, make sure that the rotor tie-down nut (or rotor lid knob) is securely fastened.
- Do not exceed the maximum rated speed of the rotor in use.
- NEVER attempt to slow or stop the rotor by hand.
- Do not lift or move the centrifuge while the rotor is spinning.
- NEVER attempt to override the door interlock system while the rotor is spinning.
- Maintain a 7.6-cm (3-in.) clearance envelope around the centrifuge while it is running. During operation you should come within the envelope only to adjust instrument controls, if necessary. Never lean on the centrifuge or place items on the centrifuge while it is operating.

Chemical and Biological Safety

Normal operation may involve the use of solutions and test samples that are pathogenic, toxic, or radioactive. Such materials should not be used in this centrifuge, however, unless *all necessary safety precautions are taken*.

- Observe all cautionary information printed on the original solution containers prior to their use.
- Handle body fluids with care because they can transmit disease. No known test offers complete assurance that they are free of micro-organisms. Some of the most virulent—Hepatitis (B and C) and HIV (I–V) viruses, atypical mycobacteria, and certain systemic fungi—further emphasize the need for aerosol protection. Handle other infectious samples according to good laboratory procedures and methods to prevent spread of disease. Because spills may generate aerosols, observe proper safety precautions for aerosol containment. Do not run toxic, pathogenic, or radioactive materials in this centrifuge without taking appropriate safety precautions. Biosafe containment should be used when Risk Group II materials (as identified in the World Health Organization *Laboratory Biosafety Manual*) are handled; materials of a higher group require more than one level of protection.
- Dispose of all waste solutions according to appropriate environmental health and safety guidelines.

It is your responsibility to decontaminate the centrifuge and accessories before requesting service by Beckman Coulter Field Service.

Allegra® 6 Series and Spinchron™ R Centrifuges

Instruction Manual

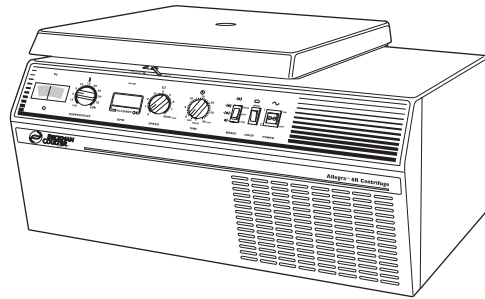

	Page
INTRODUCTION	
<i>Certification</i>	v
<i>Scope of Manual</i>	v
<i>Conventions</i>	vi
<i>Notes, Cautions, and Warnings</i>	vi
<i>CFC-Free Centrifugation</i>	vii
<i>Radio Interference</i>	vii
<i>Canadian Regulations</i>	viii
<i>Recycling Label</i>	viii
SECTION 1: DESCRIPTION	
Centrifuge Function and Specifications	1-1
Centrifuge Function	1-1
Allegra 6 and Spinchron Models	1-1
Specifications	1-3
Available Rotors	1-4
Safety Features	1-5
Name Rating Plate	1-6
Chassis	1-6
Housing	1-6
Door	1-6
Rotor Chamber	1-6
Drive	1-7
Refrigeration System	1-7
Controls and Indicators	1-8
Control Panel	1-8
SECTION 2: INSTALLATION REQUIREMENTS	
Space and Location Requirements	2-1
Electrical Requirements	2-2
Test Run	2-4
SECTION 3: OPERATION	
Run Procedures	3-1
Preparation and Loading	3-2
Starting a Run	3-4
Stopping a Run	3-6

	Page
SECTION 4: TROUBLESHOOTING	
Shutdown/No-Start Diagnostics	4-1
Other Possible Problems	4-2
Emergency Access	4-4
 SECTION 5: CARE AND MAINTENANCE	
General Maintenance	5-2
Cleaning	5-2
Decontamination	5-3
Sterilization and Disinfection	5-3
Tube Breakage	5-3
Speed Calibration	5-4
Speed Verification	5-4
Speed Knob Adjustment	5-4
Temperature Knob Adjustment	5-6
Storage and Transport	5-7
Storage	5-7
Returning a Centrifuge	5-7
Supply List	5-8
Replacement Parts	5-8
Supplies	5-8

Warranty

Illustrations and Tables

Figure 1-1.	Allegra 6 Centrifuges	1-2
Figure 1-2.	Interior View of the Centrifuge	1-7
Figure 1-3.	The Control Panel (Nonrefrigerated Model)	1-8
Figure 1-4.	The Control Panel (Refrigerated Models)	1-9
 Figure 2-1.	 Centrifuge Dimensions	 2-3
Figure 4-1.	Emergency Access	4-5
 Table 4-1.	 Shutdown/No-Start Diagnostics	 4-2
Table 4-2.	Troubleshooting Chart	4-3

CERTIFICATION

To ensure full system quality, Beckman Coulter Allegra® 6 series and Spinchron™ R centrifuges have been manufactured in an ISO 9001 or 13485 facility. They have been designed and tested to be compliant (when used with Beckman Coulter rotors) with the laboratory equipment requirements of applicable regulatory agencies. Declarations of conformity and certificates of compliance are available at www.beckmancoulter.com.

SCOPE OF MANUAL

This manual is designed to familiarize you with the Allegra 6 series and Spinchron R centrifuges, their functions, specifications, operation, and routine operator care and maintenance. We recommend that you read this entire manual, especially the SAFETY NOTICE and all safety-related information, before operating the centrifuge or performing instrument maintenance.

NOTE

The descriptions and instructions are the same for Allegra 6R and Spinchron R centrifuges. References in this manual to an Allegra 6R model also apply to the Spinchron R model.

- Section 1 contains system specifications and a brief physical and functional description of the centrifuge, including the operating controls and indicators.
- Section 2 provides instructions for installing and connecting the centrifuge.
- Section 3 contains centrifuge operating procedures.

- Section 4 lists possible malfunctions, together with probable causes and suggested corrective actions.
- Section 5 contains procedures for routine operator care and maintenance, as well as a brief list of supplies and replacement parts.

 **NOTE**

If the centrifuge is used in a manner other than specified in this manual, the safety and performance of this equipment could be impaired. Further, the use of any equipment other than that recommended by Beckman Coulter has not been evaluated for safety. Use of any equipment not specifically recommended in this manual and/or the appropriate rotor manual is the sole responsibility of the user.

CONVENTIONS

Certain symbols are used in this manual to call out safety-related and other important information. These international symbols may also be displayed on the centrifuge and are reproduced and described below and on the inside of the front cover.

NOTES, CAUTIONS, AND WARNINGS

 **NOTE**

Used to call attention to important information that should be followed during installation, use, or servicing of this equipment.



CAUTION

Used to indicate a potentially hazardous situation which, if not avoided, may result in minor or moderate injury and/or mechanical damage. It is also used to alert against unsafe practices.



WARNING

Used whenever an action or condition may potentially cause personal injury or loss of life. Mechanical damage may also result.



WARNING

Indicates high voltage or risk of electric shock. Refer servicing of all areas displaying either symbol to service personnel.

CFC-FREE CENTRIFUGATION



To ensure minimal environmental impact, no CFCs are used in the manufacture or operation of Allegra 6 series and Spinchron R centrifuges.

RADIO INTERFERENCE

This equipment has been tested and found to comply with the limits for a Class A digital device, pursuant to Part 15 of FCC Rules. These limits are designed to provide reasonable protection against harmful interference when the equipment is operated in a commercial environment. This equipment generates, uses, and can radiate radio frequency energy and, if not installed and used in accordance with this instruction manual, may cause interference to radio communications. Operation of this equipment in a residential area is likely to cause interference, in which case the user will be required to correct the interference at his own expense.

CANADIAN REGULATIONS

This equipment does not exceed the Class A limits for radio noise emissions from digital apparatus as set out in the radio interference regulations of the Canadian Department of Communications.

Le présent appareil numérique n'émet pas de bruits radioélectriques dépassant les limites applicables aux appareils numériques de Classe A prescrites dans le règlement sur le brouillage radioélectrique édicté par le Ministère des Communications du Canada.

RECYCLING LABEL



Note: On the instrument, the triangle background is yellow rather than gray.

This symbol is required in accordance with the Waste Electrical and Electronic Equipment (WEEE) Directive of the European Union. The presence of this marking on the product indicates.

- 1) The device was put on the European market after August 13, 2005 and
- 2) The device is not to be disposed via the municipal waste collection system of any member state of the European Union.

It is very important that customers understand and follow all laws regarding the proper decontamination and safe disposal of electrical equipment. For Beckman Coulter products bearing this label please contact your dealer or local Beckman Coulter office for details on the take back program that will facilitate the proper collection, treatment, recovery, recycling and safe disposal of the device.



Description

CENTRIFUGE FUNCTION AND SPECIFICATIONS

CENTRIFUGE FUNCTION

The Beckman Coulter Allegra 6 centrifuge generates centrifugal forces required for a wide variety of applications. Together with the Beckman Coulter rotors designed for use in this centrifuge, the centrifuge applications include:

- Routine processing such as sample preparations, pelleting, extractions, purifications, concentrations, phase separations, receptor binding, and column centrifugations.
- Processing large numbers of small-volume samples in multiwell plates for concentrating tissue-culture cells, cloning and replicate studies, in-vitro cytotoxicity studies, receptor binding, and genetic engineering experimentation.
- Virus isolation.
- Rapid sedimentation of protein precipitates, large particles, and cell debris.
- Preparation of subcellular organelles such as mitochondria, granules, and crude microsomes.
- Binding studies and separation of whole blood.
- Cell isolation.

ALLEGRA 6 AND SPINCHRON MODELS

The Allegra 6 (see Figure 1-1) comes in three models and the Spinchron in one:

- A nonrefrigerated compact bench model (no Spinchron model)
- A refrigerated compact bench model
- A refrigerated kneewell model (no Spinchron model)

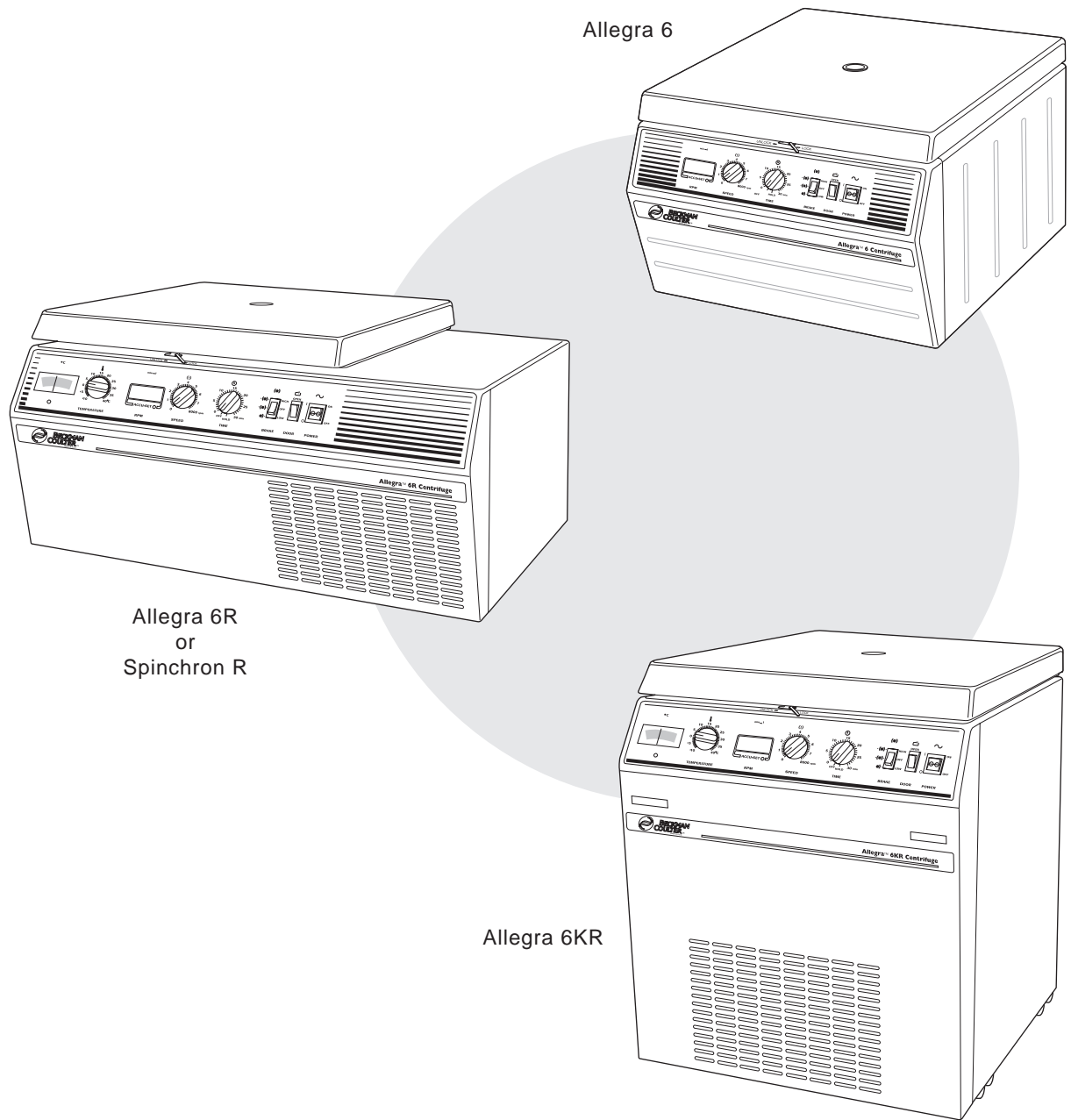

Figure 1-1. Allegra 6 Centrifuges

SPECIFICATIONS

Only values with tolerances or limits are guaranteed data. Values without tolerances are informative data, without guarantee.

	<u>Allegra 6</u>	<u>Allegra 6R/ Spinchron R</u>	<u>Allegra 6KR</u>
Speed			
Set* (in 200-rpm increments)	0 to 8000 rpm	0 to 8000 rpm	0 to 8000 rpm
Display	±30 rpm of actual	±30 rpm of actual	±30 rpm of actual
Set time			
Timed run	up to 30 min	up to 30 min	up to 30 min
Continuous run	HOLD	HOLD	HOLD
Temperature			
Temperature setting (refrigerated models only)	not applicable	-10 to 40°C	-10 to 40°C
Normal operating range (refrigerated models only)	not applicable	-5 to 25°C	-5 to 25°C
Temperature display (refrigerated models only)	not applicable	actual chamber temp ±2°C	actual chamber temp ±2°C
Ambient temperature range	10 to 35°C	10 to 35°C	10 to 35°C
Ambient temperature range for optimum operation	10 to 25°C	10 to 25°C	10 to 25°C
Humidity restrictions	<95% (noncondensing)	<95% (noncondensing)	<95% (noncondensing)
Dimensions			
Width	54.6 cm (21.5 in.)	76 cm (30 in.)	54.6 cm (21.5 in.)
Depth (overall)	66.0 cm (26.0 in.)	66 cm (26 in.)	66.0 cm (26.0 in.)
Depth (at base)	58.0 cm (23.0 in.)	58.4 cm (23.0 in.)	58.4 cm (23.0 in.)
Height, door closed	40.6 cm (16.0 in.)	39.4 cm (15.5 in.)	67.3 cm (26.5 in.)
Height, door open	96.8 cm (38.1 in.)	94.0 cm (37.0 in.)	125.7 cm (49.5 in.)
Weight	51.7 kg (114.0 lb)	75.8 kg (167.0 lb)	90.3 kg (199.0 lb)
Ventilation clearances			
(sides and rear)	7.6 cm (3.0 in.)	7.6 cm (3.0 in.)	7.6 cm (3.0 in.)
Electrical requirements			
	120 VAC, 8 A, 60 Hz	120 VAC, 12 A, 60 Hz	120 VAC, 12 A, 60 Hz
	230 VAC, 4 A, 50 Hz	230 VAC, 8 A, 50 Hz	230 VAC, 8 A, 50 Hz
	100 VAC, 10 A, 50/60 Hz	200 VAC, 10 A, 50/60 Hz	200 VAC, 10 A, 50/60 Hz
Electrical supply	Class I	Class I	Class I
Maximum heat dissipation into room under steady-state conditions			
	3073 Btu/hr (0.9 kW)	5425 Btu/hr (1.59 kW)	5425 Btu/hr (1.59 kW)
Noise level 0.91 m (3 ft) in front of centrifuge			
	<65 dBa	<65 dBa	<65 dBa
Installation (overvoltage) category	II	II	II
Pollution degree	2 [†]	2 [†]	2 [†]

* Maximum rated speed (depending on rotor in use) can be obtained only at nominal voltages (120 V for 60 Hz; 230 V for 50 Hz; 100 V for 50/60 Hz).

† Normally only nonconductive pollution occurs; occasionally, however, a temporary conductivity caused by condensation must be expected.

AVAILABLE ROTORS

Refer to the appropriate rotor manuals for complete rotor descriptions.

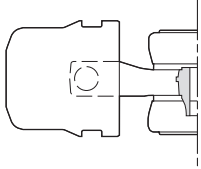
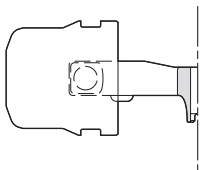
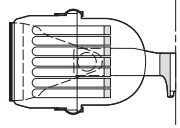
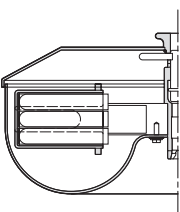
Rotor Profile and Description	Max RPM	Max RCF ($\times g$)	Max Capacity	Rotor Manual Number
GH-3.8A Horizontal (4 place)  Buckets ($r_{\max} = 204$ mm) Carriers ($r_{\max} = 163$ mm)	3750 3250	3210 1924	4 \times 750 mL 4 \times 192 mL	GS6-TB-017
GH-3.8 Horizontal (4 place)  Buckets ($r_{\max} = 204$ mm) Carriers ($r_{\max} = 163$ mm)	3750 3250	3210 1924	4 \times 750 mL 4 \times 192 mL	GS6-TB-003
PTS-2000 Horizontal (4 place)  Sector base, 100-mm tube ($r_{\max} = 170$ mm) Sector base, 75-mm tube ($r_{\max} = 160$ mm) Tube base, 16-mm tube ($r_{\max} = 176$ mm) Tube base, 13-mm tube ($r_{\max} = 176$ mm) Micro Plus carriers ($r_{\max} = 163$ mm)	3250 3250 3250 3250 3250	2010 1890 2080 2080 1920	7 \times 10 mL (each carrier) 7 \times 7 mL (each carrier) 20 \times 10 mL (each carrier) 20 \times 7 mL (each carrier) 4 \times 192 mL	SP-TB-008
GH-4.7 Horizontal (4 place)  ($r_{\max} = 182$ mm)	4730	4560	4 \times 250 mL	GS-TB-024

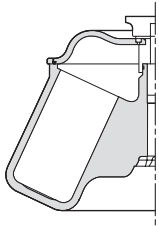
Rotor Profile and Description	Max RPM	Max RCF ($\times g$)	Max Capacity	Rotor Manual Number
GA-6 Fixed Angle, 35° (6 place)  $r_{\max} = 137 \text{ mm}$	6100	5710	6 \times 250 mL	GS-TB-023

SAFETY FEATURES

The centrifuge has been designed and tested to operate safely indoors at altitudes up to 2 000 m (6 562 ft). Safety features include the following.

- The door has an electromechanical door-locking mechanism and a secondary (manual) lock to prevent operator contact with spinning rotors. When the door is closed it locks automatically. It can be unlocked only by pressing the DOOR switch to OPEN, and opened only when the power is on, the rotor is at rest, and the manual lock is in the UNLOCK position. Two independent monitoring systems prevent the door from opening if the rotor is spinning.
- An imbalance detector monitors the rotor during the run, causing automatic shutdown if rotor loads are severely out of balance. At low speeds, an incorrectly loaded rotor can cause imbalance. Rotor instability can also occur if the centrifuge is moved while running, or if it is not resting on a level surface.
- An anchoring system is provided to secure the centrifuge in place. The anchoring system (bolts that anchor a benchtop centrifuge to the laboratory bench; a stationary tray to roll a kneewell centrifuge into for operation) is designed to minimize the possibility of injury or damage that could result from centrifuge movement in the event of a major rotor mishap.

NAME RATING PLATE

The name rating plate is affixed to the rear of the centrifuge. Check that the line voltage agrees with the voltage listed on this name rating plate before connecting the centrifuge. Always mention the serial number and the model number shown when corresponding with Beckman Coulter regarding your centrifuge (the serial number is also on the inside of the door).

CHASSIS

HOUSING

The centrifuge housing is made of sheet steel over a steel chassis and is finished with acrylic baking enamel. The control panel overlay is made of coated polycarbonate. Polyvinyl chloride and polyester foam panels line the interior walls of the centrifuge housing for sound and temperature insulation.

DOOR

The structural steel door has a strobe port for speed verification. In nonrefrigerated models, the door has two filtered air-intake ports for rotor cooling. An electromechanical door lock system, together with a manual lock, prevents run initiation unless the door is closed and latched. When a run is in progress, the door locks automatically and can not be opened unless the power is on, the rotor is virtually stopped (spinning less than 40 rpm), and the manual lock is in the UNLOCK position. If there is a power failure, the door lock can be manually tripped for sample recovery (see Section 4, TROUBLESHOOTING).

ROTOR CHAMBER

The aluminum rotor chamber (Figure 1-2) is coated with a chemical-resistant epoxy finish. The drive shaft and neoprene rubber boot surrounding the drive shaft are visible in the chamber bottom. A neoprene gasket around the chamber top assures sealing. (Centrifuge gaskets have not been designed as bioseals for aerosol containment.) The thermistor is also visible in refrigerated models.

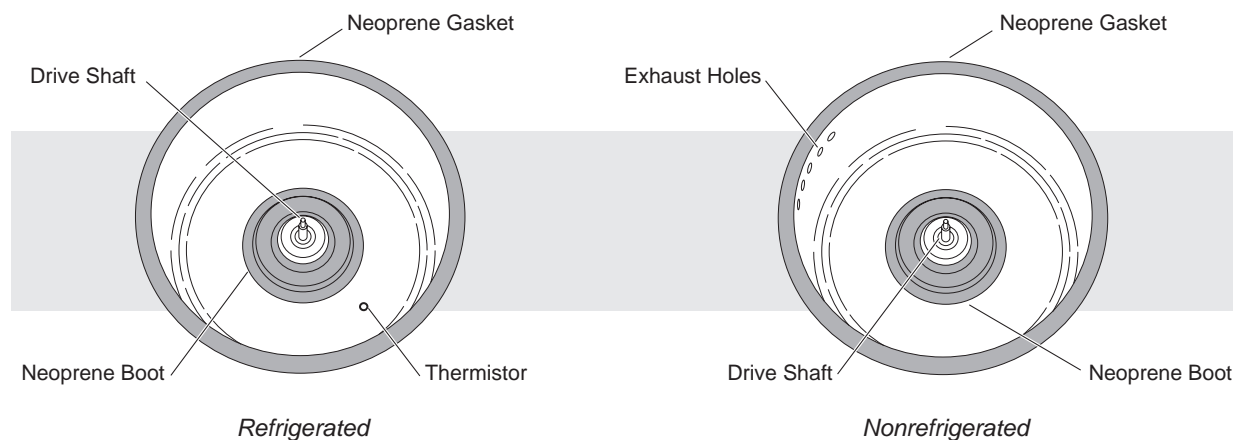

Figure 1-2. Interior View of the Centrifuge

Nonrefrigerated models only—During centrifugation, the rotor movement draws air through the filtered air-intake ports in the door into the chamber bowl, where it circulates around the rotor. Holes in the side of the bowl allow air to flow out to the exhaust ports beneath the centrifuge. This air flow provides cooling for the rotor.

DRIVE

The direct-drive motor has permanently lubricated, sealed bearings. A tie-down screw (or rotor knob) secures the rotor to the drive shaft. The resilient suspension ensures that loads will not be disturbed by vibration, and prevents damage to the drive shaft if an imbalance occurs during centrifugation.

REFRIGERATION SYSTEM (Refrigerated Models Only)

A refrigeration compressor circulates CFC-free refrigerant through copper tubing wrapped around the chamber bowl, which is insulated to increase refrigeration efficiency. A thermistor regulates the compressor to maintain chamber temperature to $\pm 2^{\circ}\text{C}$ of set temperature.

NOTE

To avoid chamber icing, refrigeration is off when the door is open. The centrifuge door must be closed *and locked* for the refrigeration system to begin operating.

CONTROLS AND INDICATORS

CONTROL PANEL

Mounted at an angle on the centrifuge front for easy visibility and access, the control panel (Figure 1-3, nonrefrigerated model; Figure 1-4, refrigerated models) comprises indicators, control knobs, and switches.

POWER

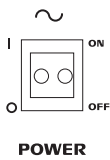

This two-position rocker switch, labeled I (ON) and O (OFF), controls electrical power to the centrifuge. The switch lights up when the power is on.

DOOR



When pressed to OPEN, this toggle switch releases the latch mechanism and allows the door to be opened (the rotor must be stopped, the power must be on, and the manual lock in UNLOCK position).

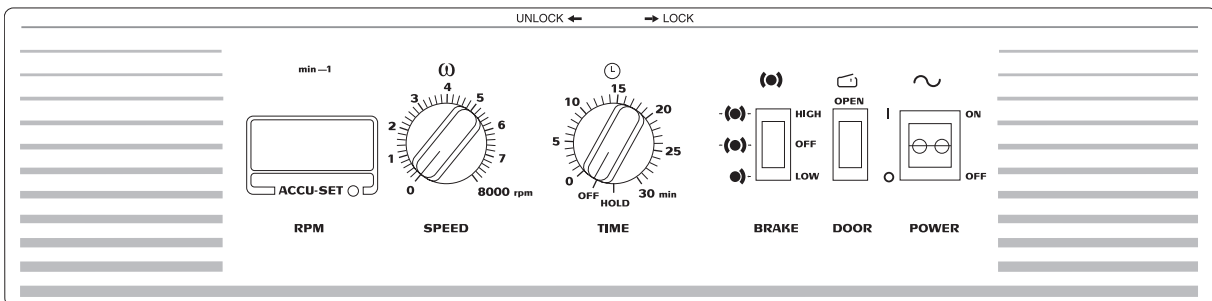

Figure 1-3. The Control Panel (Nonrefrigerated Model)

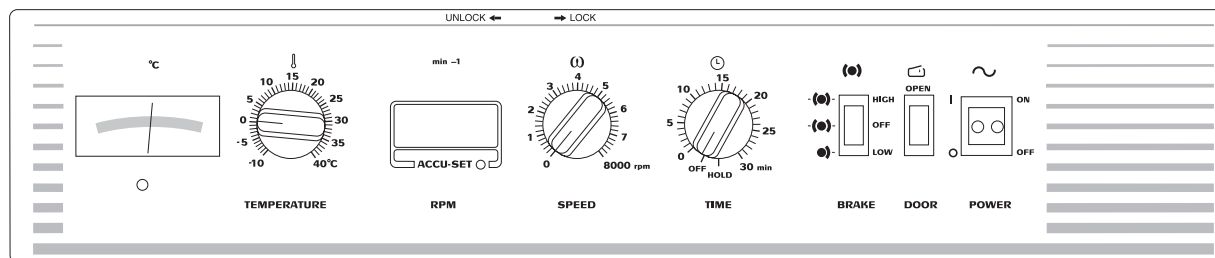
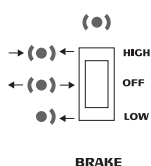

Figure 1-4. The Control Panel (Refrigerated Models)

BRAKE



This switch is used to select the brake mode used during deceleration. Refer to the appropriate rotor manual for acceleration and deceleration times for available rotors under various conditions. The three positions of the switch provide:

- **HIGH** position activates high dynamic braking that starts immediately after the timer turns the motor off. When rotor speed reaches 50 rpm, all braking stops and the rotor coasts to a stop.
- **OFF** removes braking entirely and allows the rotor to coast to a stop from set speed.
- **LOW** position activates low dynamic braking down to 50 rpm, and is used for slower deceleration to avoid remixing or resuspension of the sediment.

TIME

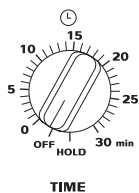

This variable-setting knob may be set for timed runs or longer-duration continuous runs. Either type of run can be stopped at any time by switching the timer to OFF.

- **Timed runs**—the knob may be set for any run time up to 30 minutes in 1-minute increments.
- **Continuous runs**—with the knob set to **HOLD**, the centrifuge will run until turned off.

SPEED

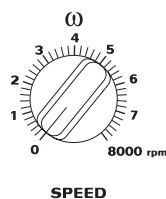

The variable-setting knob is used to set the drive speed, in 200-rpm increments, up to 8000 rpm. For precise speed adjustments, the ACCU-SET button can be pressed as the speed knob is turned until the required speed appears on the RPM display. The centrifuge will accelerate to the set speed and maintain that speed for the duration of the run.¹ ACCU-SET can be adjusted at any time during a run.

¹ Actual speed may fluctuate due to line voltage variation.

RPM

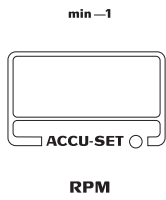

When centrifuge power is turned on, the display shows “0000.” During the run the display indicates actual rotor speed to the nearest 10-rpm increment. If the run is shut down prematurely due to one of four conditions (see Section 4, TROUBLESHOOTING), the diagnostic message “8880” will be displayed.

TEMPERATURE (refrigerated models only)

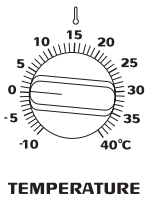

This knob is used to set the operating temperature between -10 and +40°C in 1°C increments. (Recommended operating temperature range is from -5 to +25°C.) A thermistor in the chamber regulates the compressor to maintain chamber temperature $\pm 2^\circ\text{C}$ of the set temperature.²

NOTE

Longer continuous runs are required to achieve temperatures higher than 25°C.

°C (refrigerated models only)

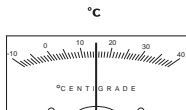

Displays the temperature ($\pm 2^\circ\text{C}$) within the chamber bowl.

² Temperature control is referenced for 25°C ambient; temperature performance at higher ambient will depend on the rotor in use and environmental conditions.

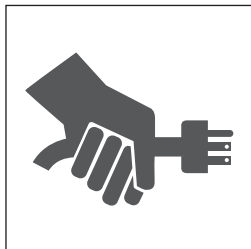

Installation Requirements

**WARNING**

This centrifuge weighs 51.7 kg/114.0 lb (nonrefrigerated benchtop), 75.8 kg/167.0 lb (refrigerated benchtop), or 90.3 kg/199.0 lb (refrigerated kneewell). DO NOT attempt to lift or move it without assistance from another person.

**WARNING**

Do not place the centrifuge near areas containing flammable reagents or combustible fluids. Vapors from these materials could enter the centrifuge's air system and be ignited. Never bring any flammable substances within the 30-cm (1-ft) area surrounding the centrifuge. Maintain a clearance envelope of 7.6 cm (3 in.) around an operating centrifuge. No persons should be within this clearance envelope while the centrifuge is operating.

SPACE AND LOCATION REQUIREMENTS

Carefully remove the centrifuge and accessories from the shipping container. Save the container and packing materials for possible future relocation or storage of the centrifuge.

- Select a location away from heat-producing laboratory equipment, with sufficient ventilation to allow for heat dissipation.
- Position the centrifuge on a level surface (a sturdy table or laboratory bench for benchtop models) that can support the weight of the centrifuge (refer to SPECIFICATIONS in Section 1) and resist vibration.
- Allow a 7.6-cm (3-in.) clearance at each side and the back of the centrifuge to ensure sufficient air circulation. Dimensions are shown in Figure 2-1. The centrifuge must have adequate air ventilation to ensure compliance to local requirements for vapors produced during operation.
- Do not operate the centrifuge in ambient temperatures exceeding 35°C (95°F). Relative humidity should not exceed 95% (noncondensing).

Use the appropriate anti-rotation kit to secure the centrifuge to the working surface. The anti-rotation kit is designed to minimize the possibility of injury or damage that could result from centrifuge movement in the event of a rotor mishap.

- The anchoring kit for a benchtop centrifuge contains bolts to secure the centrifuge to the table or bench. Complete instructions (SP-TB-007) for installing the anti-rotation kit are included with the kit, which is shipped with the centrifuge.
- The anchoring kit for a kneewell centrifuge contains a stationary tray to roll the centrifuge into for operation. Complete instructions (GS6-TB-007) for installing the anti-rotation kit are included with the kit, which is shipped with the centrifuge.

ELECTRICAL REQUIREMENTS

Allegra 6	Allegra 6R/ Spinchron R	Allegra 6KR
120 VAC, 8 A, 60 Hz	120 VAC, 12 A, 60 Hz	120 VAC, 12 A, 60 Hz
230 VAC, 4 A, 50 Hz	230 VAC, 8 A, 50 Hz	230 VAC, 8 A, 50 Hz
100 VAC, 10 A, 50/60 Hz	200 VAC, 10 A, 50/60 Hz	200 VAC, 10 A, 50/60 Hz

A 1.8-m (6-ft) power cord with grounded plug is supplied with the centrifuge. In regions where a different plug is required to meet local electrical and safety requirements, contact your local Beckman Coulter representative.

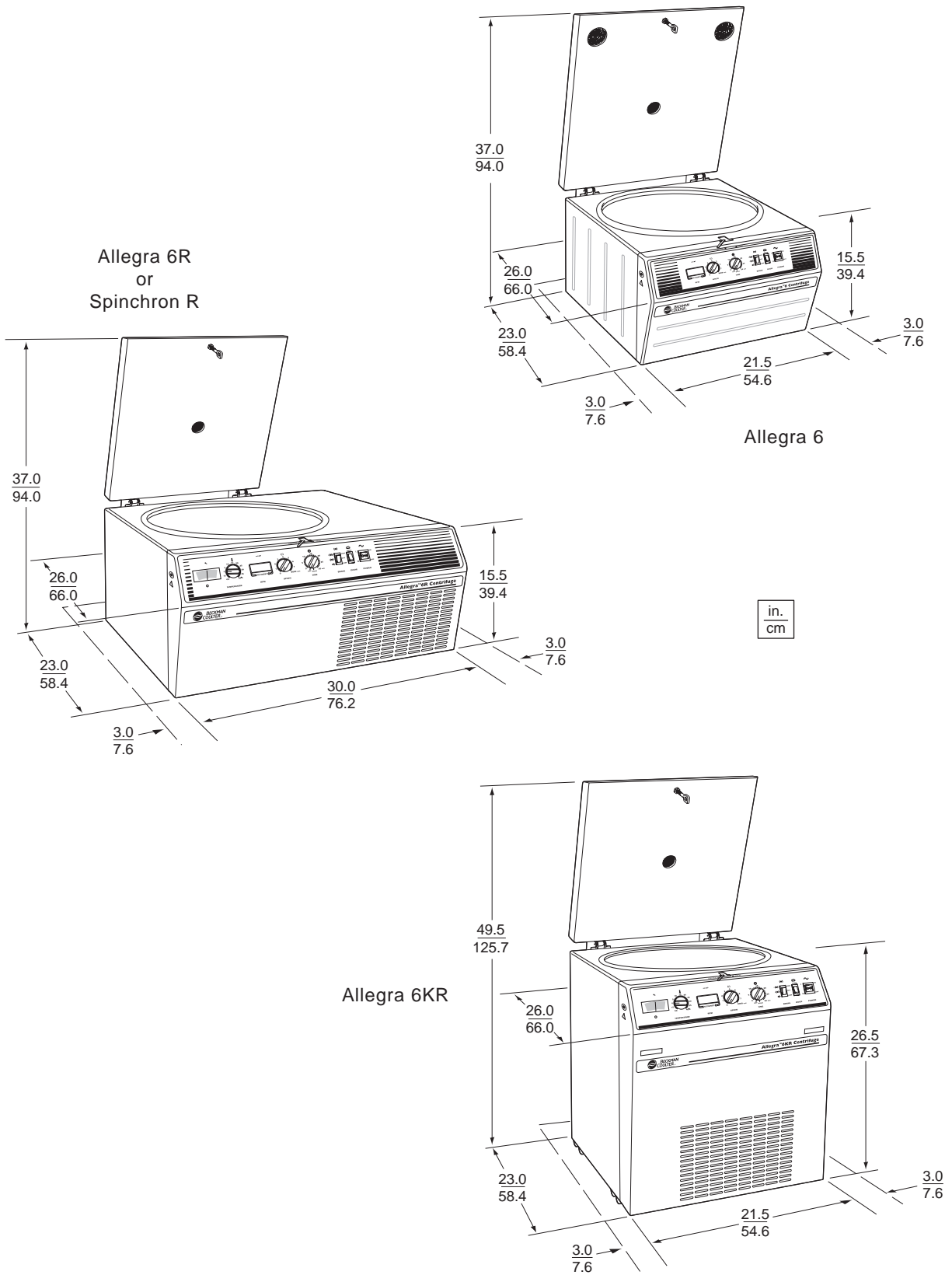

Figure 2-1. Centrifuge Dimensions

Make sure the voltage imprinted on the name rating plate affixed to the back of the centrifuge agrees with the line voltage of the outlet used. With the POWER switch in the OFF (O) position, plug in both ends of the centrifuge power cord. If there is any question about voltage, have a qualified service person measure it under load while the drive is operating.

To reduce the risk of electrical shock, this equipment uses a three-wire electrical cord and plug to connect the centrifuge to earth-ground. To preserve this safety feature:

- Make sure that the matching wall outlet receptacle is properly wired and earth-grounded.
- Never use a three-to-two wire plug adapter.
- Never use a two-wire extension cord or a two-wire non-grounding type of multiple-outlet receptacle strip.

To ensure safety, the centrifuge should be wired to a remote emergency switch (preferably outside the room where the centrifuge is housed, or adjacent to the exit from that room), in order to disconnect the centrifuge from the main power source in case of a malfunction.

TEST RUN

NOTE

During transport between areas with varying temperatures, condensation may occur inside the centrifuge. Allow sufficient drying time before running the centrifuge.

We recommend that you make a test run to ensure that the centrifuge is in proper operating condition after shipment. See Section 3 for instructions on operating the centrifuge.

After completing the test run, return the preaddressed warranty card included with this literature. This will validate the centrifuge warranty and ensure your receipt of further information regarding new accessories and/or modifications as they become available.

**WARNING**

The centrifuge must not be used in the vicinity of flammable liquids or vapors, and such materials should not be run in the centrifuge. Never bring any flammable substances within the 30-cm (1-ft) area surrounding the centrifuge. During operation you should not come within the 7.6-cm (3-in.) clearance envelope except to adjust centrifuge controls, if necessary. Do not lean on the centrifuge or place items on the centrifuge while it is operating.

RUN PROCEDURES

The following detailed operating procedures describe operation of the centrifuge. Refer to the appropriate rotor manual for instructions on preparing the rotor for centrifugation.



WARNING

Handle body fluids with care because they can transmit disease. No known test offers complete assurance that they are free of micro-organism. Some of the most virulent—Hepatitis (B and C) and HIV (I–V) viruses, atypical mycobacteria, and certain systemic fungi—further emphasize the need for aerosol protection.

Handle other infectious samples according to good laboratory procedures and methods to prevent spread of disease. Because spills may generate aerosols, observe proper safety precautions for aerosol containment. Use only the appropriate rotors and adapters. Do not run toxic, pathogenic, or radioactive materials in this centrifuge without taking appropriate safety precautions. Biosafe hoods should be used when Risk Group II materials (as identified in the World Health Organization *Laboratory Biosafety Manual*) are handled; materials of a higher group require more than one level of protection.

PREPARATION AND LOADING

Action

Result

1. Ensure that the power cord is plugged into a wall receptacle that provides the correct voltage.

Power is available to the centrifuge.

2. Press the POWER switch to ON (I).

Power is applied to the system.

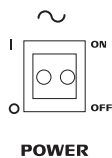

Action

3. Move the manual lock lever to the left (UNLOCK).



4. Press DOOR to OPEN position, then lift the door up.



DOOR

5. Install the rotor or rotor yoke. Be sure the base is seated on the drive shaft, with the pin in the rotor groove.

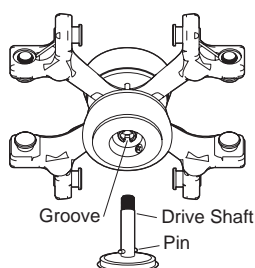

6. Load the rotor according to the rotor manual. Always run the rotor with a balanced load; fill all positions on a swinging bucket rotor yoke with buckets and/or carriers.

Result

Door remains open.

**CAUTION**

Never drop the rotor onto the centrifuge drive shaft. The shaft can be damaged if the rotor is dropped onto it or forced sideways.

The rotor is ready to load. (You can load fixed angle rotors either before or after installing the rotor in the centrifuge.)

**WARNING**

Do not substitute a metal fastener for the plastic tie-down nut supplied with the rotor. If a tie-down nut comes off the shaft during centrifugation, the *plastic* nut furnished will break apart in the chamber, causing minimal damage to the centrifuge. A loose *metal* object could substantially damage the rotor, chamber, and lid, and could potentially escape the chamber into the laboratory, causing personal injury or property damage.

Action

7. Firmly fasten the tie-down nut on the shaft using the torquing bar (356036). Do not overtighten the nut.

8. Close the door. Push firmly down until you hear a clicking (latching) sound indicating that the door is latched.
9. Move the manual lock lever to the right (LOCK).



Result

The rotor is secured to the shaft.

NOTE

The tie-down nut is in the lid knob on the GA-6 fixed angle rotor. If you are using this rotor, install the lid and turn the knob to the right (clockwise) until firmly fastened on the shaft.

STARTING A RUN

Action

1. Set run speed.
 - Press and hold the ACCU-SET button.
 - Rotate the SPEED dial to the selected speed.

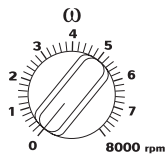

- Release the ACCU-SET button.

Result

The selected speed shows on the display.



Action

2. Select the brake position.

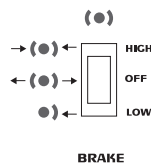

3. Set the TEMPERATURE knob to the required run temperature (refrigerated models only).

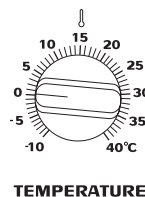

4. Turn the TIME control to the required run time.

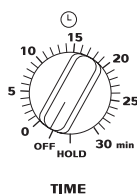

As the run begins, acceleration control protects delicate gradients; when the rotor reaches about 200 rpm, full acceleration to set speed occurs.

- The digital RPM display indicates the rotor speed.
- The TIME control knob shows the time remaining in the run.
- The °C display indicates the chamber temperature (refrigerated models only).

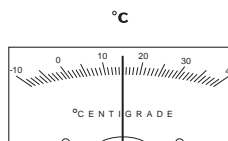

NOTE

Turn the knob to the right (clockwise) for time setting or to the left (counterclockwise) to HOLD.

CAUTION

Do not attempt to override the door interlock system while the rotor is spinning. Do not lift or move the centrifuge while the rotor is spinning.

STOPPING A RUN

A timed run ends automatically when the TIME control counts down to zero. To end a run in progress for any reason:

Action

1. Turn the TIME control knob to OFF.

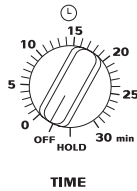

2. After the rotor stops spinning, move the manual lock lever to the left (UNLOCK).



3. Press the DOOR switch to OPEN.

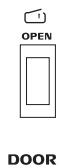

Result

The door interlock system will keep the door latched until the rotor has virtually stopped (spinning less than 40 rpm).

NOTE

Do not stop a run by turning the SPEED knob to 0. This will disengage the brake and the rotor will coast to a stop, which could take a long time. Always use the TIME knob to stop a run.

The door interlock system will release the latch and allow the door to be opened when the rotor speed is 40 rpm or less. However, for operator safety, do not open the door until the rotor has come to a complete stop.



CAUTION

If disassembly reveals evidence of leakage, you should assume that some fluid escaped the rotor. Apply appropriate decontamination procedures to the centrifuge and accessories.

After completing a run, unload the rotor as described in the appropriate rotor manual. It is not necessary to remove the rotor from the centrifuge between runs unless the rotor or chamber bowl needs to be cleaned. (If the rotor is left in the centrifuge between runs, make sure the rotor is seated on the drive shaft and the tie-down nut is tight before each run.)

NOTE

Accumulations of sample, dust, and/or glass particles from broken sample tubes can ruin rotor pins and cause rotor vibrations. To prevent these accumulations, remove the rotor and clean the centrifuge bowl often. See CLEANING in Section 5.



Troubleshooting

NOTE

It is your responsibility to decontaminate the centrifuge, as well as any rotors and accessories, before requesting service by Beckman Coulter representatives.

SHUTDOWN/NO-START DIAGNOSTICS



If one of the conditions described in Table 4-1 shuts the centrifuge down prematurely, the rotor will decelerate to a stop and the RPM display will show “8880.” Refer to Table 4-1 to determine the nature of the problem and recommended corrective actions. Possible causes for each problem are listed in the probable order of occurrence. Perform the recommended corrective action in sequence, as listed. If the problem persists, call Beckman Coulter Field Service.

To help diagnose and correct the problem, try to provide as much information as possible:

- Note the operating situation when the error occurred (such as speed or load type).
- Note any unusual environmental and/or operating conditions (such as ambient temperature or voltage fluctuations).
- Add any other information that may be helpful.

OTHER POSSIBLE PROBLEMS

Possible malfunctions not indicated by diagnostic messages are described in Table 4-2, along with probable causes and corrective actions required. Possible causes for each problem are listed in the probable order of occurrence. If you are unable to correct the problem, call Beckman Coulter Field Service.

Table 4-1. Shutdown/No-Start Diagnostics

Probable Cause	Recommended Action
Imbalance detector tripped	<ol style="list-style-type: none"> 1. Turn the TIME knob to OFF and press the POWER switch to OFF (O). 2. Check to be sure the rotor is in good condition and is loaded symmetrically around the center of rotation, with containers of equal weight and density opposite each other. <p>NOTE If you are using a swinging bucket rotor, fill all yoke positions with buckets and/or carriers. Always run the rotor with a balanced load (refer to the applicable rotor manual for complete loading information).</p> <ol style="list-style-type: none"> 3. Be sure the rubber boot is undamaged and is seated correctly over the dust cover. 4. After a 30-second delay, press the POWER switch to ON (I) to reset the imbalance detector circuit. You should be able to restart the run normally. <p>NOTE It is possible to trip the imbalance detector switch during rotor installation or loading. Performing these actions with the power off will avoid the problem. If the imbalance switch is tripped, however, turn power to the centrifuge off, then back on to reset the circuit.</p>
Thermal cutoff switch activated	<ol style="list-style-type: none"> 1. Turn the TIME knob to OFF and press the POWER switch to OFF (O). 2. Check that ambient temperature is within the limits shown under SPECIFICATIONS in Section 1. 3. Check for air inlet obstruction and dirty air-inlet filters. Clean as required (see Section 5, Care and Maintenance). 4. After the motor has cooled (approximately 15 minutes with the door open), press the POWER switch to ON (I) to reset the thermal protector circuit. If the problem persists, call Beckman Coulter Field Service.
Chamber over-temperature (refrigerated models only)	<ol style="list-style-type: none"> 1. Turn the TIME knob to OFF and press the POWER switch to OFF (O). 2. Check that ambient temperature is within the limits shown under SPECIFICATIONS in Section 1. 3. Check for air inlet obstruction and dirty air-inlet filter. Clean as required (see Section 5, Care and Maintenance). 4. Check chamber temperature; if it is <i>overtemperature</i>, call Beckman Coulter Field Service.
Tachometer signal loss	Call Beckman Coulter Field Service.

Table 4-2. Troubleshooting Chart

Problem	Probable Cause	Recommended Action
Centrifuge does not start	Power not on	Plug in power cord; press POWER switch to ON (I). Verify proper power to wall outlet.
Rotor cannot achieve set speed	Line voltage below rating	Measure line voltage while the centrifuge is operating.
	Imbalance detector not reset	Press POWER switch to OFF (O) position; after 30 seconds, turn it back ON (I).
	Thermal protector not reset after rotor cools	Press POWER switch to OFF (O) position; after 60 seconds, turn it back ON (I).
	Electrical failure	Check connections; call Beckman Coulter Field Service.
	Motor bearings or commutator worn	Motor needs replacing; call Beckman Coulter Field Service.
	Motor failure	Call Beckman Coulter Field Service.
Set temperature cannot be achieved (refrigerated models only)	Ambient temperature too high	Reduce ambient temperature.
	Run too short to achieve temperature	Precool rotor; run for a longer time.
	Temperature knob needs adjustment	Adjust knob (see Section 5, Care and Maintenance).
	Dirty filter	Clean filter (see Section 5, Care and Maintenance).
	Rotor hot	Precool rotor.
	Excess moisture in chamber	Wipe out moisture before each run.
	Tear or break in chamber gasket	Call Beckman Coulter Field Service.
Refrigeration or electronic problem	Call Beckman Coulter Field Service.	
Temperature cannot be maintained (refrigerated models only)	Ambient temperature too high	Reduce ambient temperature.
	Rotor speed higher than rated	Reduce rotor speed.
	Dirty filter	Clean filter (see Section 5, Care and Maintenance).
	Refrigeration or electronic problem	Call Beckman Coulter Field Service.
Door will not open	Power not on	Plug in power cord; press POWER switch to ON (I).
	Rotor spinning over 40 rpm	Wait until rotor stops.
	Secondary latch lever in LOCK position	Move latch lever to UNLOCK.
	Latch stuck	See EMERGENCY ACCESS, below.
Rotor speed shows "0000" and rotor is spinning	Display malfunction	Call Beckman Coulter Field Service.
Rotor speed display is blank	Power not on	Plug in power cord; press POWER switch to ON (I).
	Fuse blown	Call Beckman Coulter Field Service.
Chamber icing (refrigerated models only)	Excess humidity in chamber	Wipe out moisture before each run.
	Condensation build-up between runs	Turn refrigeration off between runs by one of the following: <ul style="list-style-type: none"> • Leave door open between runs. • Turn TEMPERATURE knob to a setting higher than ambient temperature. • Turn centrifuge power off.

EMERGENCY ACCESS

If the facility power fails, the centrifuge will resume operation when power is restored and the rotor will return to set speed. In the event of an extended power failure, it may be necessary to trip the door-locking mechanism manually to remove the rotor and retrieve your sample.



WARNING

The following procedure may expose the operator to the possibility of contact with a spinning rotor. Turn the power off and disconnect the centrifuge from the main power source before proceeding. Never attempt to override the door interlock system while the rotor is spinning.

Action

1. Press the POWER switch to OFF (O) and unplug the power cord from the power source.

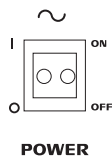

Result

No indicators are lit.

2. Make sure that the rotor is not spinning.
3. Move the secondary latch lever to UNLOCK.
4. Insert a 4-mm ($5/32$ -inch) internal hex wrench into the access opening in the centrifuge side panel (see Figure 4-1).

No sound or vibration comes from the centrifuge.

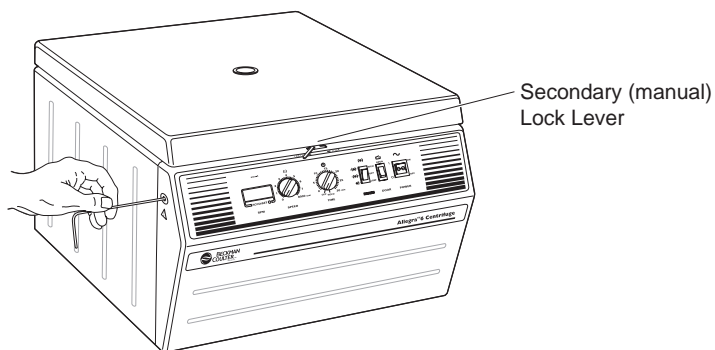

Figure 4-1. Emergency Access

Action

5. Turn the hex wrench to the right (clockwise) until you hear a “click” or the door opens.

Result

The latch releases and the door can be opened.

If the rotor is still spinning, *close the door and wait until it stops before attempting to remove it.*



WARNING

Never try to slow or stop the rotor by hand.

6. Open the door and remove the sample.

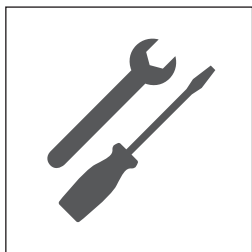

Care and Maintenance

For maintenance not covered in this manual, contact Beckman Coulter Field Service (1-800-742-2345 for Allegra 6 models or 1-800-854-3633 for Spinchron models; customers outside the United States should contact their local Beckman Coulter representative). Refer to the applicable rotor manual and Chemical Resistances (publication IN-175) for instructions on the care of rotors and rotor accessories.



WARNING

Any maintenance procedure or servicing of this equipment that requires removal of any covers can expose parts which involve the risk of electric shock or personal injury. Make sure that the POWER switch is OFF (O) and the centrifuge is disconnected from the main power source, and refer such servicing to qualified service personnel.

Do not use alcohol or other flammable substances in or near operating centrifuges.



NOTE

It is your responsibility to decontaminate the centrifuge, as well as any rotors and accessories, before requesting service by Beckman Coulter Field Service.

GENERAL MAINTENANCE

Perform the following procedures regularly to ensure satisfactory performance and long service life of the centrifuge.

- Regularly inspect the interior of the rotor chamber for accumulations of sample, dust, or glass particles from broken sample tubes. Clean as required (see CLEANING, below), as these accumulations can result in rotor vibrations.
- Regularly check the air intake and exhaust vents for obstructions. Keep vents clear and clean.
- To prevent the rotor from sticking, lubricate the drive shaft with Spinkote (306812) at least once a month (depending on usage), and after each cleaning.

NOTE

Before using any cleaning or decontamination methods except those recommended by the manufacture, users should check with the manufacturer that the proposed method will not damage the equipment.

CLEANING



Frequent cleaning will ensure proper operation and prolong the life of the centrifuge. *Always clean up spills when they occur to prevent corrosives or contaminants from drying on component surfaces.*

- To prevent accumulations of sample and/or dust, keep the interior of the rotor chamber clean and dry by frequent wiping with a cloth or paper towel. Remove the rotor and wash the bowl often, using a mild detergent such as Beckman Solution 555™ (339555). Dilute the detergent 10 to 1 with water. Rinse thoroughly and dry completely. Spray the centrifuge bowl with antistatic solution and wipe it clean. (Anti-static wipes are also available.)
- Clean the drive shaft, shaft cavity, threads, and the tie-down screw at least once a week using a mild detergent such as Solution 555 and a soft brush. Dilute the detergent 10 to 1 with water. Rinse thoroughly and dry completely. Lubricate the drive shaft with Spinkote (306812) after cleaning.

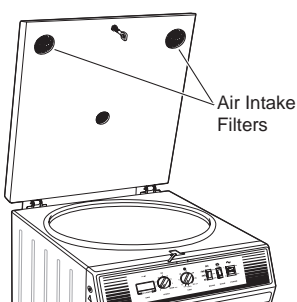

- Clean the centrifuge case and door by wiping with a cloth dampened with Solution 555. Do not use acetone or other solvents.
- Use a soft brush or vacuum to clean the air intake vent filter when dust accumulates.
- (Nonrefrigerated models only) Remove the air-intake filters and inspect for dust and dirt. Wash them using a mild soap or detergent such as Solution 555. Rinse well and squeeze excess water out, then air-dry before reinserting.

DECONTAMINATION



If the centrifuge and/or accessories are contaminated with radioactive or pathogenic solutions, perform appropriate decontamination procedures. Refer to *Chemical Resistances* to be sure the decontamination method will not damage any part of the centrifuge.

STERILIZATION AND DISINFECTION

Ethanol (70%)¹ may be used on the centrifuge surface. See *Chemical Resistances* for more information regarding chemical resistance of centrifuge and accessory materials.

While Beckman Coulter has tested these methods and found that they do not damage the centrifuge, no guarantee of sterility or disinfection is expressed or implied. When sterilization or disinfection is a concern, consult your laboratory safety officer regarding proper methods to use.

TUBE BREAKAGE

If a glass tube breaks, and all the glass is not contained in the bucket or rotor, thoroughly clean the interior of the chamber bowl.



CAUTION

Be careful when examining or cleaning the gasket or chamber, as sharp glass fragments may be embedded in their surfaces.

¹ Flammability hazard. Do not use in or near operating centrifuges.

- Examine the gasket to make sure that it is free of glass particles. Carefully remove any glass particles that may remain. If glass is under the gasket, call Beckman Coulter Field Service to replace the gasket.
- Carefully wipe away any glass particles that remain in the bowl.

SPEED CALIBRATION

SPEED VERIFICATION

To compare the actual rotor speed with the set speed, proceed as follows, using a digital strobe.

Action

1. Install a rotor.
2. Secure the rotor tie-down nut onto the drive shaft.
3. Place a strip of reflective tape on half of the tie-down nut.
4. Shut the centrifuge door. Move the secondary latch lever to LOCK.
5. Set the SPEED knob to the selected speed.
6. Turn the TIME knob to HOLD.
7. When the rotor reaches set speed, use a calibrated strobe at the strobe port to verify the actual rotor speed is within ± 30 rpm of the display.

Result

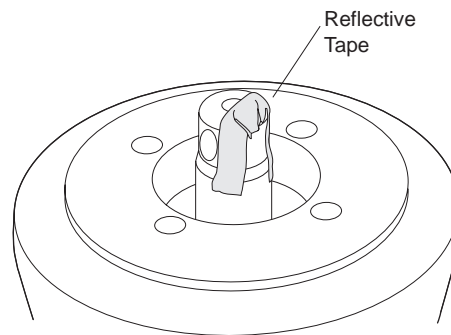

The centrifuge will start.

If there is a discrepancy, check the calibration of your strobe. If you cannot determine the problem, call Beckman Coulter Field Service.

SPEED KNOB ADJUSTMENT

If set and indicated speed are not in agreement, the SPEED knob may need adjustment.

Action

1. Install a rotor.
2. Set the SPEED knob to 3000 rpm.

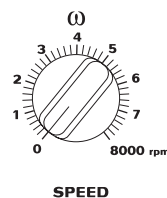

3. Check that the door is shut and securely latched. Move the secondary latch lever to LOCK.
4. Turn the TIME knob to HOLD.

The centrifuge will start.

5. When the rotor speed stabilizes, adjust the knob until the displayed speed is 3000 rpm.



6. Loosen the two setscrews on the speed knob (one at each end of the knob). Rotate the knob on the shaft until it indicates 3000 rpm. Tighten the setscrews.

TEMPERATURE KNOB ADJUSTMENT (Refrigerated Models Only)

If set and indicated temperature are not in agreement, the TEMPERATURE knob may need adjustment.

Action

1. Turn the centrifuge power off.
2. Tap lightly on the °C meter until the needle is centered at 15°C.
3. Turn the power back on and set the TEMPERATURE control knob to 40°C.

Result

4. Check that the door is completely closed and the manual latch lever is in LOCK position.
5. Let the centrifuge run for a short time until the temperature needle stabilizes.
6. Rotate the knob slowly toward a colder setting (such as 20°C) until the compressor turns on. Loosen the two setscrews in the knob (one on each end of the knob) and set the knob to the indicated temperature.

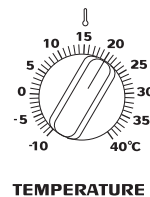
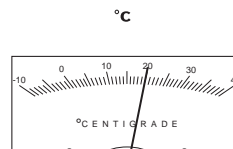
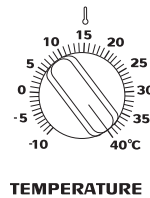
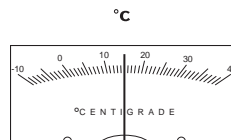

Action**Result**

-
7. Repeat step 6 until set and indicated temperatures are within one degree of each other.

STORAGE AND TRANSPORT

STORAGE

Before storing a centrifuge for an extended period, return it to the original shipping container to protect it from dust and dirt. Temperature and humidity conditions for storage should meet the environmental requirements described under SPECIFICATIONS, in Section 1.

RETURNING A CENTRIFUGE

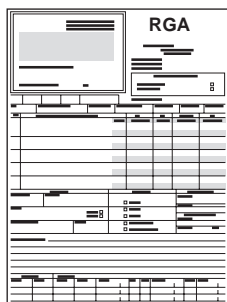

Before returning a centrifuge or accessory for any reason, prior permission (a Returned Goods Authorization form) must be obtained from Beckman Coulter, Inc. Contact your local Beckman Coulter office to obtain the RGA form and for packaging and shipping instructions.

To protect our personnel, it is the customer's responsibility to ensure that all parts are free from pathogens and/or radioactivity. Sterilization and decontamination must be done before returning the parts.

*All parts must be accompanied by a signed note, plainly visible on the outside of the box, stating that they are safe to handle and that they are not contaminated with pathogens or radioactivity. **Failure to attach this notification will result in return or disposal of the items without review of the reported problem.***

SUPPLY LIST

Contact Beckman Coulter Sales (1-800-742-2345 in the United States; worldwide offices are listed on the back cover of this manual) for information about ordering parts and supplies. See the Beckman Coulter Benchtop *Rotors, Tubes & Accessories* catalog (BR-9742, available at www.beckmancoulter.com) for detailed information on ordering rotors, tubes, and accessories. For your convenience, a partial list is given below. Refer to the rotor manual for materials and supplies needed for rotors.

NOTE

Publications referenced in this manual can be obtained by calling Beckman Coulter at 1-800-742-2345 in the United States, or by contacting your local Beckman Coulter office.

REPLACEMENT PARTS

Power cord (60-Hz).....	961919
Power cord (50-Hz).....	355810
Neoprene boot.....	358009
Front panel knob.....	974672
Rotor tie-down nut.....	356035
Rotor tie-down nut for GS-3.8A rotor.....	366642
Tie-down nut O-ring.....	927571
Torquing bar.....	356036

SUPPLIES

Anti-Seize (1 1/2 oz).....	961660
Spinkote lubricant (2 oz).....	306812
Silicone vacuum grease (1 oz).....	335148
Beckman Solution 555 (1 qt).....	339555

ALLEGRA 6 AND SPINCHRON CENTRIFUGE WARRANTY

Subject to the exceptions and upon the conditions specified below and the warranty clause of the Beckman Coulter, Inc. terms and conditions in effect at the time of sale, Beckman Coulter agrees to correct either by repair or, at its election, by replacement, any defects of material or workmanship which develop within one (1) year after delivery of an Allegra 6 Series or Spinchron centrifuge (the product), to the original buyer by Beckman Coulter or by an authorized representative, provided that investigation and factory inspection by Beckman Coulter discloses that such defect developed under normal and proper use.

Some components and accessories by their nature are not intended to and will not function for as long as one (1) year. A complete list of such components or accessories is maintained at the factory and at each Beckman Coulter District Sales Office. The lists applicable to the products sold hereunder shall be deemed to be part of this warranty. If any such component or accessory fails to give reasonable service for a reasonable period of time, Beckman Coulter will repair or, at its election, replace such component or accessory. What constitutes either reasonable service and a reasonable period of time shall be determined solely by Beckman Coulter.

REPLACEMENT

Any product claimed to be defective must, if requested by Beckman Coulter, be returned to the factory, transportation

charges prepaid, and will be returned to Buyer with the transportation charges collect unless the product is found to be defective, in which case Beckman Coulter will pay all transportation charges.

CONDITIONS

Beckman Coulter shall be released from all obligations under all warranties, either expressed or implied, if the product(s) covered hereby are repaired or modified by persons other than its own authorized service personnel, unless such repair in the sole opinion of Beckman Coulter is minor, or unless such modification is merely the installation of a new Beckman Coulter plug-in component for such product(s).

DISCLAIMER

IT IS EXPRESSLY AGREED THAT THE ABOVE WARRANTY SHALL BE IN LIEU OF ALL WARRANTIES OF FITNESS AND OF THE WARRANTY OF MERCHANTABILITY AND THAT NEITHER BECKMAN COULTER, INC., NOR ITS SUPPLIERS SHALL HAVE ANY LIABILITY FOR SPECIAL OR CONSEQUENTIAL DAMAGES OF ANY KIND WHATSOEVER ARISING OUT OF THE MANUFACTURE, USE, SALE, HANDLING, REPAIR, MAINTENANCE, OR REPLACEMENT OF THE PRODUCT.



Beckman Coulter, Inc. • 250 S. Kraemer Blvd. • Brea, California 92821
Sales and Service: 1-800-742-2345 • Internet: www.beckmancoulter.com

©2009 Beckman Coulter, Inc.
All rights reserved

