

**Sartorius laboratory.
L 220 S, L 420 D, L 420 P,
L 420 S, L 610 D.**

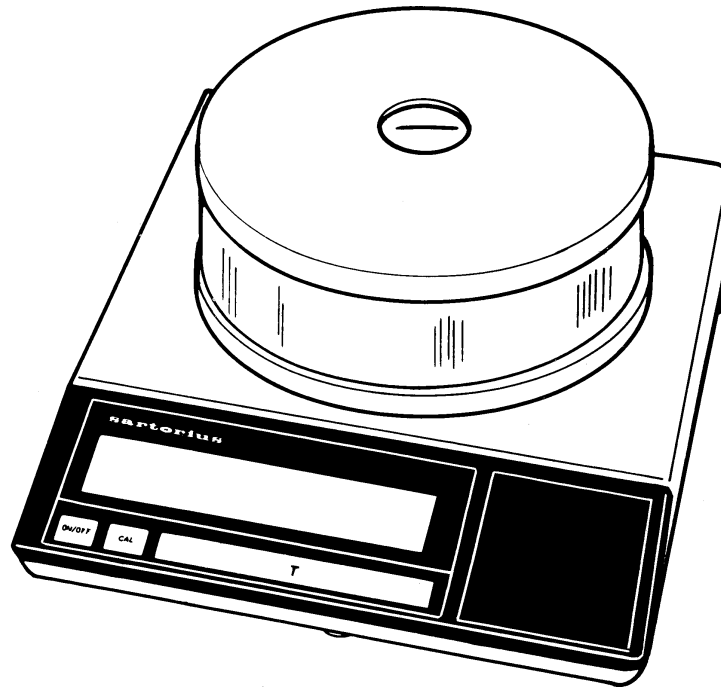

Electronic Toploader
Installation and operating instructions

sartorius

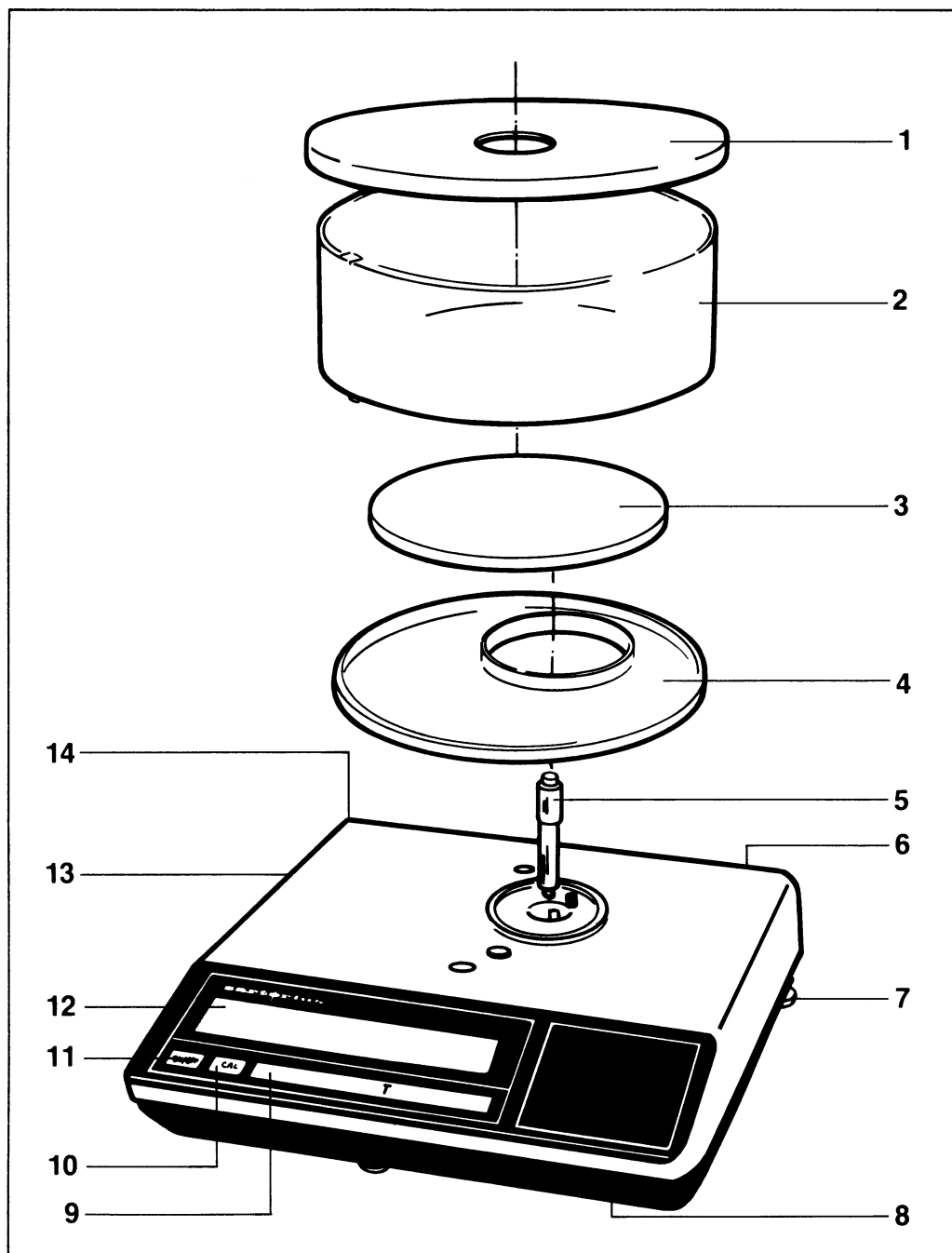

- | | | | |
|---|-----------------------------|----|----------------------|
| 1 | Draft protection lid | 8 | Unlocking switch |
| 2 | Glass cylinder | 9 | Tare bar |
| 3 | Pan | 10 | CAL button |
| 4 | Draft protection base plate | 11 | ON/OFF-Taste |
| 5 | Pan receptacle | 12 | Weight display |
| 6 | Power connection socket | 13 | Manufacturer's label |
| 7 | Leveling screw | 14 | Level indicator |

Sartorius laboratory. L 220 S, L 420 D, L420 P, L 420 S, L 610 D.

With this Sartorius Balance you have acquired a sophisticated, top-of-the-line electronic weighing instrument that will help ease your dally work load.

Please read these installation and operating instructions carefully before operating your new balance.

Pursuant to the German Directive for the Implementation of Regulations for Prevention of Accidents "Elektrische Anlagen und Betriebsmittel (VBG 4)" [Electrical Installations and Equipment] of April 1986, it is hereby certified that the equipment delivered, "electronic precision balance, model L 220 S, L 420 D, L 420 P, L 420 S or L 610 D," is manufactured and tested in compliance with the following DIN/VDE regulations

DIN IEC 348/VDE 0411:
Safety requirements for electronic measuring apparatus

DIN IEC 380/VDE 0806:
Safety of electrically energized Office machines

DIN IEC 601/VDE 0750:
Safety of medical electrical equipment

When you use electrical equipment in installations and under ambient conditions requiring higher safety Standards, you must comply with the provisions as specified in the applicable regulations for installation in your country.

Contents

Equipment Supplied	5
Installation Instructions	5
Startup	6
Operation	7
Calibration	8
Balance Operating Program	10
Accessories (Options)	13
Technical Data	14

Equipment Supplied

Do not miss out on the benefits of our full warranty. Please fill out the warranty card, indicating the date of installation, and return the card to your Sartorius dealer.

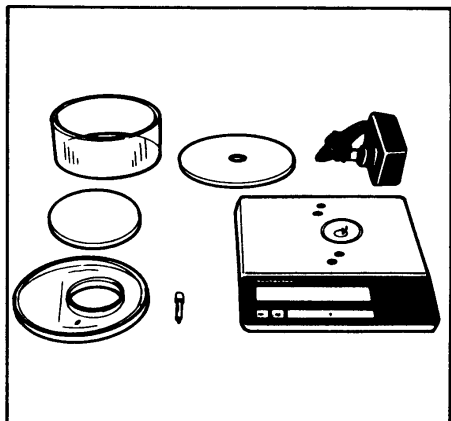

The equipment supplied comprises the components shown on the left.

Save the packaging material and the box for shipping your balance to prevent any damage caused during transportation.

Installation Instructions

Choose a suitable place to set up your balance. It should not be exposed to the following:

- heat radiation
- aggressive/corrosive substances
- vibrations
- drafts.

Your Sartorius Balance will provide accurate readouts even when it is exposed to unfavorable conditions. You can adapt it to your requirements simply by changing the menu code settings of the balance operating program. For this purpose, please read pages 10 through 12.

After you have plugged in your balance using the AC adapter, allow for at least 30 minutes' warmup.

Important Note

Unplug the AC adapter before you connect or disconnect peripherals.

Startup

Attach the dust cover by pressing down on the adhesive disks, and install components (5 - 1) on the balance one at a time in the order indicated.

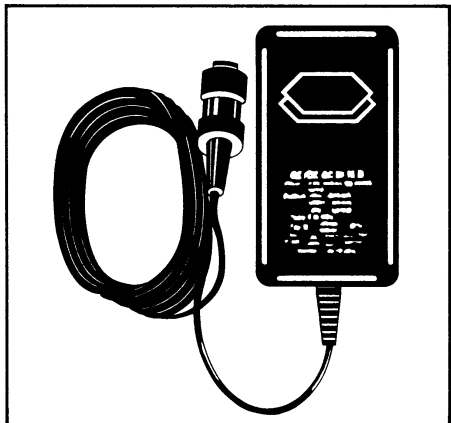

Your balance is powered by an AC adapter. Please make sure that the voltage rating printed on this unit is identical to your local line voltage rating.

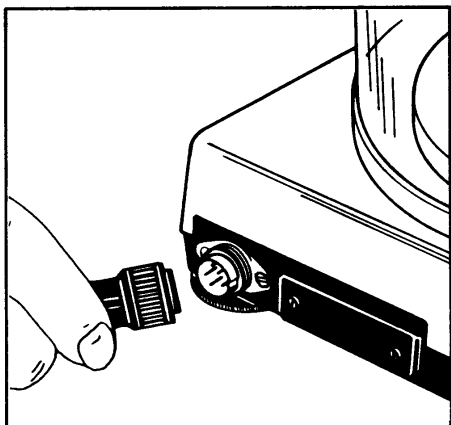

Plug the AC adapter cord into the power receptacle of the balance. Secure the connection by tightening the knurled collar. Now plug the AC adapter into a wall outlet.

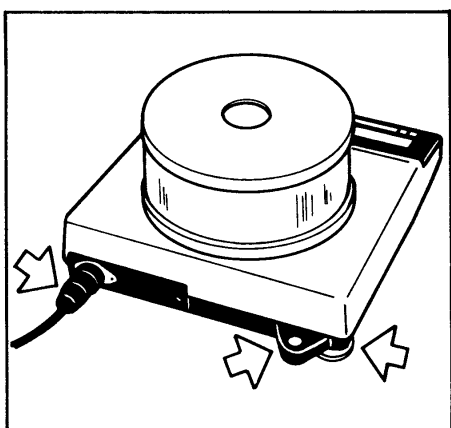

At the point of use, level the balance using the leveling feet (7) so that the air bubble is centered within the circle of the level indicator (14) (for models L 220 S, L 420 P and L 420 S only).

Operation

The weight display shows the following special Status messages for your information:

BUSY

The processor is still busy processing a function and will not accept any other commands to perform functions at this time.

STANDBY

The balance has been turned off with the ON/OFF key (11) and is now in the STANDBY mode and ready to operate without warmup.

POWER OFF

The balance was disconnected from line power (reconnection to power, power failure).

CAL

The calibration function has been activated.

In addition to grams, this balance gives you a variety of other international weight unit options to work with.

Select the weight unit you need from the table of the menu options for the balance operating program, and set the appropriate code as described in the section "Balance Operating Program."

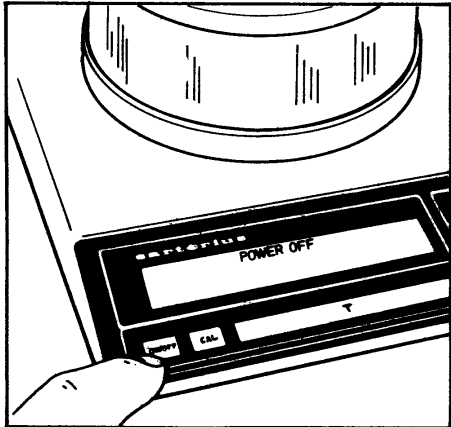

Press the ON/OFF key **(11)** to switch the balance on or off. You can also turn on the balance with the tare control **(9)**.

After the balance has been plugged into the AC adapter, the weight display will go out whenever you turn off the balance. All other electronic circuits will remain energized (STANDBY state). This means the balance is immediately ready to operate without requiring warmup the next time you switch it on.

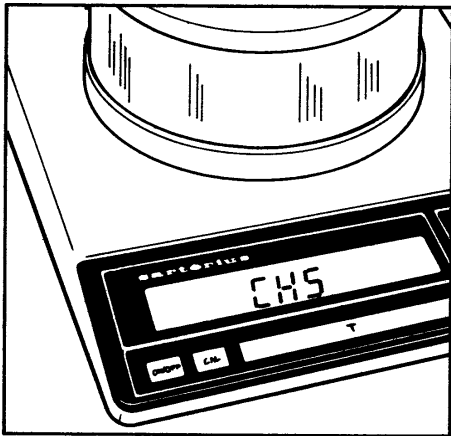

After the power is turned on, a test of all essential functions is run automatically.

The self-test ends with the readout 0.00 g (if the factory code setting 5 1 1 is used).

Now place your sample or object on the pan **(3)** to determine the weight. Read off the weight in the display **(12)** as soon as the weight unit (in this case "g") appears as the stability symbol.

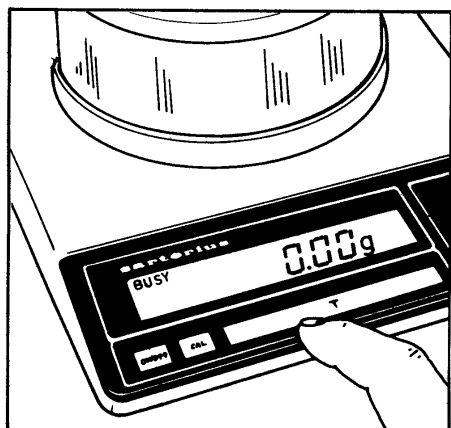

If you wish to use a Container to weigh or if the weight display does not indicate 0.00 g (or the equivalent with the weight unit of your choice), press the tare control to zero the display.

Calibration

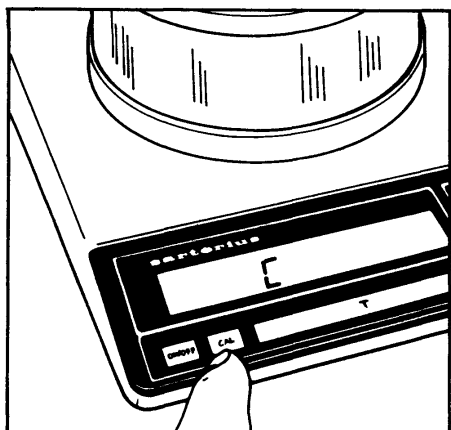

Internal Calibration: (only for the L 220 S, and L 420 S)

Clear the pan and zero the display.
As soon as the display indicates 0.000 g, press the CAL key (10). "C" will now be displayed. If "CE" is displayed instead, zero the display by pressing the tare control and press the CAL key again.

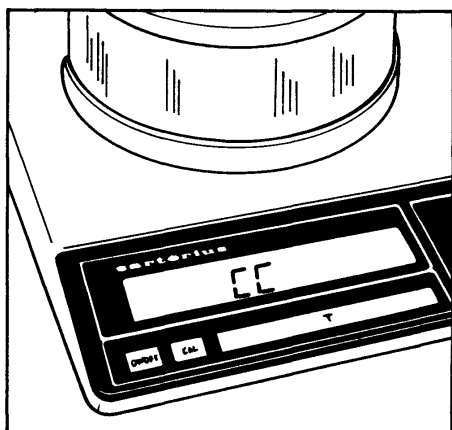

After a few seconds, the display will indicate "CC" followed by 0.000 g. An acoustic Signal indicates the end of the calibration procedure.

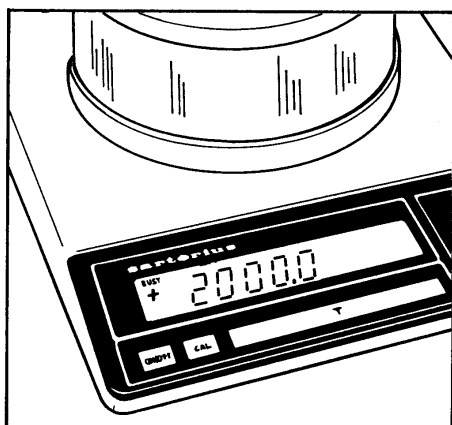

External Calibration:

- This is only possible with an accurate calibration weight (L 220 S-200 g; L 420 P, L 420 S-400 g; L 610 D-500 g)

Clear the pan and press the tare control (9) for at least three seconds until the calibration weight readout appears in the display.

Center the calibration weight on the pan. Now the weight unit symbol is displayed. An acoustic signal indicates the end of the calibration procedure.

You can block access to the internal and external calibration functions - to find these menu codes, refer to the "Balance Operating Program." (These functions are accessible whenever the balance operating program is unlocked using the menu access switch).

Balance Operating Program

The balance operating program lets you adapt your balance to various ambient conditions and to different weighing requirements, and select the weight unit(s) commonly used in your country. At the factory, we have set the codes for a Standard program, which is protected by a locking function to prevent accidental changes.

The **"menu code"** contains the information of the operating program, It consists of three digits, known as the page (1st digit), the line (2nd digit) and the word (3rd digit) in "computerese."

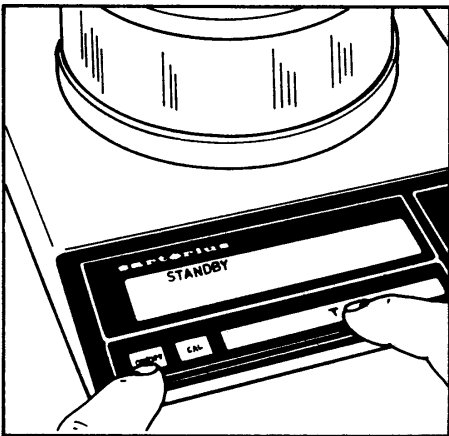

How to access the menu of the balance operating program:

With the balance turned off (STANDBY state), hold down the tare control (8) and briefly press the ON/OFF key (11).

Upon completion of the automatic self-test, release the tare control as soon as "CH5" is displayed. The Status of the balance operating program will appear in the weight display: "L" Stands for the list mode. In this mode, you can check the menu code settings, but you cannot program new menu codes. If you wish to change a program menu code, you must first unlock the menu access switch to access the program menu.

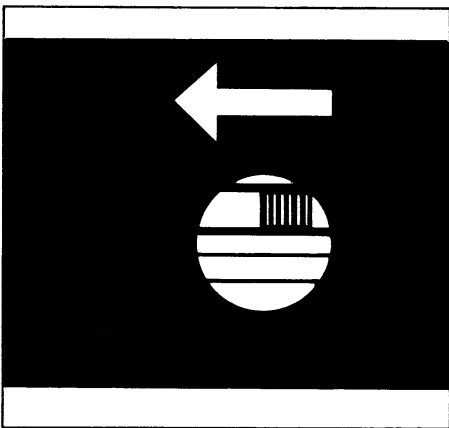

To do so, remove the protective cap located on the front right of your balance and slide the menu access switch (8) in the direction of the arrow.

The display will indicate "C," which Stands for the change mode, meaning you can now change the menu code settings.

After you have accessed the menu of the operating program, the display will show a continuous sequence of numbers from 0-5 for the "page" or first digit of the code, in addition to the Status code letter "L" or "C."

When the first digit of the code you wish to check or change appears, press the tare control (14). The "page" code number (1st digit) now stops in the display, and a series of numbers for the 2nd digit or "line" will begin to cycle. Press the tare control again to stop the code number of your choice in the display. Next, the numbers for the "word" (last digit) will cycle in the display. Repeat the procedure to enter the last digit of the code.

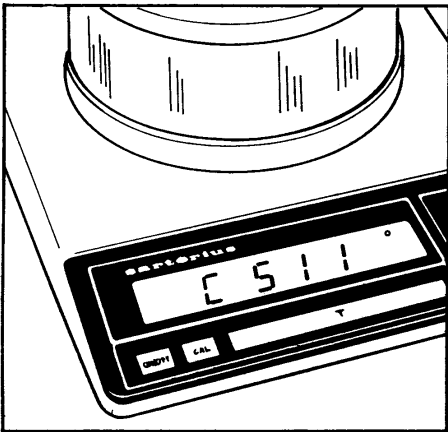

The "o" symbol that appears indicates the actual setting.

To change any menu code settings ("C" mode), press the tare control as soon as the appropriate numeric code is displayed.

Brief display of BUSY and the "o" symbol confirms your selection, followed by a return to "zero" for the 2nd digit or "line."

How to return to the weighing mode:
press the tare control each time a 0 appears in the numerical sequence (word, line, page). If you have changed a menu code, your code entry will be stored as soon as the display returns to the weighing mode. Lock the balance operating program using the menu access switch ("L" readout) and replace the protective cap.

Auto Zero

This balance has an automatic zero tracking function known as "Auto Zero" (can be turned off by menu code).

Any change off zero ≤ 1 digit per second will be set to zero automatically.

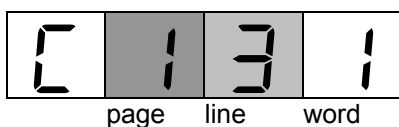

Menu of the Balance Operating Program (Active Parameters)

	<i>Factory setting</i>		<i>Factory setting</i>
Code	Ambient Conditions	Code	Internal Calibration
[1 1 1]	Very stable	[1 7 1]	Accessible
[1 1 2]	Stable	[1 7 2]	Access blocked
[1 1 3]	Unstable		
[1 1 4]	Very unstable		
Code	Stability Range	Code	Program Lock
[1 2 1]	0,25 digit	[4 1 1]	OFF
[1 2 2]	0,5 digit	[4 1 2]	ON
[1 2 3]	1 digit		
[1 2 4]	2 digits		
[1 2 5]	4 digits	Code	Acoustic Signal
[1 2 6]	8 digits	[4 3 1]	ON
[1 2 7]	16 digits	[4 3 2]	OFF
[1 2 8]	32 digits		
[1 2 9]	64 digits		
Code	Display Format	Code	Weight Units¹⁾
[1 3 1]	Last decimal ON	[5 1 1]	Grams g
[1 3 2]	Last decimal OFF	[5 1 2]	Kilograms kg
[1 3 3]	Last decimal at stability	[5 1 3]	Carats ct
[1 3 4]	All decimals at stability	[5 1 4]	Pounds lb
Code	Tare Parameter	[5 1 5]	Ounces oz
[1 4 1]	Without stability	[5 1 6]	Troy ounces ozt
[1 4 2]	At stability	[5 1 7]	Parts/pound o
Code	Auto Zero	[5 2 1]	Hong Kong taels tl
[1 5 1]	ON	[5 2 2]	Singapur taels tl
[1 5 2]	OFF	[5 2 3]	Taiwan taels tl
Code	External Calibration	[5 2 4]	Grains gr
[1 6 2 1]	Accessible	[5 2 5]	Pennyweights dwt
[1 6 2]	Access blocked	[5 2 6]	Mommes o
		[5 2 7]	Milligrams o
		[5 2 8]	Karats o
		[5 2 0]	Call program line
		[5 0]	Call program page
		[0]	End of programming

Additional Parameters for the data Output format at the interface port and for calculation programs are available on request.-Please refer to the "Accessories."

¹⁾ You can choose any weight unit as long as it can be displayed in the particular weighing range you selected (for example do not set the code for "kg" when you are using a 0.1 mg balance).

Accessories (Options)

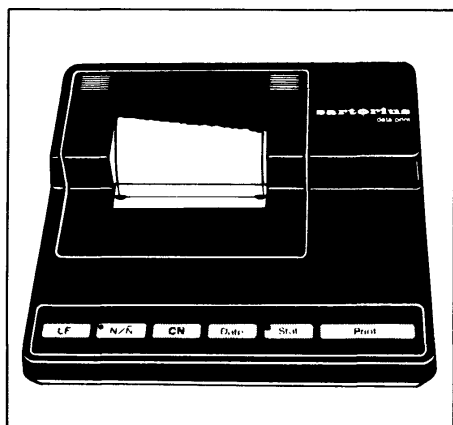

Data printer, with date/time and statistics functions	YDP02-OD
Print speed, approx. lines/sec.	1.5
Printer housing (W x D x H) in mm	150 x 138 x 43

Calibration weights for:	
L 420 D	
L 420 P (4 x 100 g)	7072 04
L 610 D (1 x 500 g)	7072 16
Interface	YDO 01 L
"PLUS" Performance Package, integratable (incl. interface)	YDO 01 L+
Over/under check weighing/ sorting & classification	
Mass unit conversion	
Weight of residue in %/change in %	
Statistics - Net total/ formulation & compounding	
Filling toward "0" - Parts counting	
Animal weighing	
Calculations by a factor	
Calculation of the weight per unit area/division	
Accumulator memory - I.D. no. memory	
Communication with Computers	
Thermo Control infrared dryer, programmable	YTC 01 L
Remote display (can be plugged into the interface port of the balance)	
LCD, reflective	7371 01 A
for overhead projectors, transmissive	7371 02 A
Extra-large special draft shield	YDS 01 L
Carrying case	YDB 02 L
Antiheft locking device	6087
Dust cover	69 60L220

Technical data

Model		L 220 S	L 420 D
Weighing range	g	222	40/424
Readability	g	0.001	0.001/0.01
Tare range (by subtraction)	g	-222	-424
Standard deviation	g	≤± 0.001	≤± 0.001/0.005
Max. linearity deviation	g	≤± 0.0015	≤± 0.001/0.01
Stabilization time (typical)	s	2	
Display update rate	s	0.1 ... 0.8 (selectable)	
Adaption to ambient conditions and application requirements		by selection of one of four digital filter levels	
Stability range	d	0,25 ... 64 (selectable)	
Ambient temperature range	K	+273 ... +313	
Sensitivity drift within 283 ... 303 K	/K	≤± 5·10 ⁻⁶	
Pan dimensions	mm	Ø130 (approx. 5.1 in.)	
Clearance above pan		50 (approx. 2 in.)	
Weighing chamber (Ø and H)		148 and 60 (5.8 and 2.4 in.)	
Balance housing (W x D x H) (without draft shield)	mm	220 x 235 x 60 (height incl. draft protection = 127 mm or 5 in.)	
Net weight, ca.	kg	4,5 (9.9lbs)	
Power requirements (voltage; frequency: 50 – 60 Hz)		100/120 V or 220/240 V, depending on the power supply unit (adapter) used	
Power consumption	VA	7 (typical)	
Interface (optional)		RS 232 C/V24 – 28, RS 423/V10; 7-bit; parity: even, mark, odd, space; transmission rates: 150 ... 9600 Baud	

Technical data

Model		L 420 P	L 420 S	L 610 D
Weighing range	g	80/160/424	424	60/606
Readability	g	0.001/0.002/0.005	0.001	0.001/0.01
Tare range (by subtraction)	g	-424	-424	-606
Standard deviation	g	≤± 0.001/0.001/0.0025	≤± 0.001	≤± 0.001/0.005
Max. linearity deviation	g	≤± 0.0015/0.002/0.005	≤± 0.002	≤± 0.001/0.01
Stabilization time (typical)	s	2		
Display update rate	s	0.1 ... 0.8 (selectable)		
Adaption to ambient conditions and application requirements		by selection of one of four digital filter levels		
Stability range	d	0.25 ... 64 (selectable)		
Ambient temperature range	K	+273 ... +313		
Sensitivity drift within 283 ... 303 K	/K	≤± 5·10 ⁻⁶		
Pan dimensions	mm	Ø130 (approx. 5.1 in.)		
Clearance above pan		50 (approx. 2 in.)		
Weighing chamber (Ø and H)		148 and 60 (5.8 and 2.4 in.)		
Balance housing (W x D x H) (without draft shield)	mm	220 x 235 x 60 (height incl. draft protection = 127 mm or 5 in.)		
Net weight, ca.	kg	4,5 (9.9lbs)		
Power requirements (voltage; frequency: 50 – 60 Hz)		100/120 V or 220/240 V, depending on the power supply unit (adapter) used		
Power consumption	VA	7 (typical)		
Interface (optional)		RS 232 C/V24 – 28, RS 423/V10; 7-bit; parity: even, mark, odd, space; transmission rates: 150 ... 9600 Baud		

Sartorius AG

✉ 37070 Göttingen

📦 Weender Landstraße 94–108, 37075 Göttingen

☎ (0551) 308-0, 📠 (0551) 308-3289

Internet: <http://www.sartorius.com>

Copyright by Sartorius AG, Göttingen, Deutschland.

All rights reserved. No part of this publication may be printed or translated in any form or by any means without the prior written permission of Sartorius AG.

Sartorius AG reserves the right to make change to the technology, features, specification and design of the equipment without notice.

The Sartorius logo consists of the word "sartorius" in a bold, lowercase, sans-serif font. A vertical line passes through the center of the letter 'o', which is highlighted in yellow. The line extends above and below the letter.