

Multimatic® 220 AC/DC

MIG, Stick and AC/DC TIG Package 

Quick Specs

Light Industrial Applications

Light fabrication
Maintenance and repair
Auto body
Farm/home

Processes

MIG (GMAW)
Flux-cored (FCAW)
AC/DC TIG (GTAW)
Pulsed TIG (GTAW-P)
DC stick (SMAW)

Input Power 120/240 V, 1-phase, 50/60 Hz

Amperage Range **MIG:** 30–230 A
AC/DC TIG: 20–210 A
DC stick: 30–200 A

Net Weight 56 lb. (25.4 kg)

The Multimatic 220 AC/DC. It does... so you can too.

Ideal for hobbyists and small shops, the Multimatic 220 AC/DC gives you the freedom to weld any process — MIG, flux-cored, AC/DC TIG, and stick — with one portable, powerful, easy-to-use machine. Setup and switching processes are fast and easy, all while ensuring excellent arc quality using either 120- or 240-volt power.



IMPROVED!

Now with **NEW!**
MDX Series MIG gun.

All in One



Multiple processes
with only one machine

Easy to Use



Auto polarity,
process and settings



Quick and easy setup

Portable



Light enough to easily
move around your
garage or shop



Welder is warranted for three years, parts and labor.
Gun warranted for 90 days, parts only.



Miller Electric Mfg. LLC
An ITW Welding Company
1635 West Spencer Street
P.O. Box 1079
Appleton, WI 54912-1079 USA

Equipment Sales US and Canada
Phone: 866-931-9730
FAX: 800-637-2315
International Phone: 920-735-4554
International FAX: 920-735-4125

MillerWelds.com



Multimatic® 220 AC/DC Features and Benefits

All in One

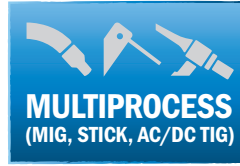

Take on more projects with one machine that has MIG, AC/DC TIG, and DC stick.

MIG: 24 ga.–3/8 in. steel
18 ga.–3/8 in. aluminum

AC/DC TIG: 24 ga.–1/4 in. steel and aluminum

DC stick: 16 ga.–3/8 in. steel

The Multimatic 220 AC/DC comes equipped with all accessories to weld any process, unlike other machines where you need to purchase additional accessories.

Easy to Use



With our innovative QuickTech™ technology, setup and changing processes is even easier.

- Automatically determines the polarity. Work is always connected to the bottom right receptacle. MIG gun and TIG torch can stay connected at the same time.

- Automatically switches to the right process. Just hit the trigger or the foot control and the machine automatically changes, eliminating the need to manually change processes.
- Automatically recalls the settings from the last process used.



Auto-Set™ Elite fast and easy predefined settings for multiple materials and processes to help you get welding quickly.

- Available for all processes (MIG, AC/DC TIG, DC stick) with the ability to fine-tune your settings.

- Set weld parameters by selecting:
MIG (shown) – wire diameter and material thickness
AC/DC TIG – tungsten diameter and material thickness
DC stick – electrode type, diameter and material thickness

MDX™-100 MIG gun with AccuLock™ MDX

consumable system features a dual-locked, front-loading liner that optimizes wire feedability.

- Install AccuLock contact tips with a single turn.
- AccuLock liner locks at front and back of gun to align with contact tip and power pin for a flawless wire feed path.
- Durable, ergonomic handle with overmolding improves grip and comfort.
- Ball-and-socket handle with rear swivel for increased gun maneuverability while reducing welder fatigue.

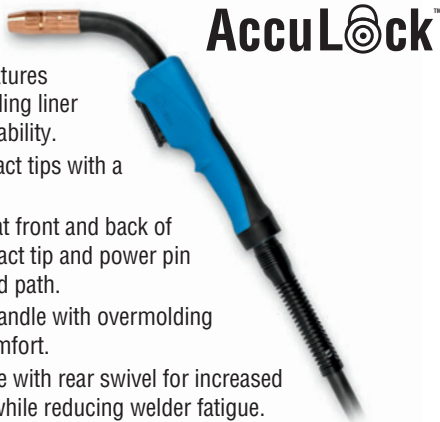

Pro-Set™ (TIG and stick manual modes)

eliminates the guesswork when setting weld parameters. Simply adjust control until Pro-Set appears on the display and the number turns blue.

- AC Balance (AC TIG) — controls the cleaning action (Pro-Set 75%)
- AC Frequency (AC TIG) — controls the width of the arc cone (Pro-Set 120 Hz)
- Pulse (DC TIG) — helps focus the arc for increased stability, penetration and travel speed (Pro-Set 100 Hz)
- DIG (Stick) — lets you tailor arc characteristics for a wide range of applications (Pro-Set 30% 7018 electrodes)



Robust, angled wire drive with Quick Select™ drive roll for easily changing one wire type/diameter to another. Quick Select drive roll offers three grooves — two for different size solid wires and a third for flux-cored wire.



Two shielding gas connections so both gases can be left connected to the machine, no switching needed. One connection for MIG gas and one for TIG gas.

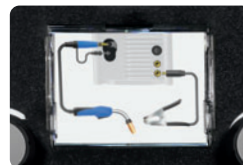

Easy-to-understand interface with 3.5-inch color LCD display and intuitive connection setup images.

Multimatic® 220 AC/DC Features and Benefits

Portable



Weighing only 56 pounds, the Multimatic 220 AC/DC can go where the work is, plus the added convenience of one machine versus two or more.

Optional dual cylinder rack cart

Dual cylinder rack cart offers portability while holding two gas cylinders.



Versatile



Operates on 120-volt or 240-volt power letting you work virtually anywhere. Multi-voltage plug (MVP™) easily connects to common 120-volt or 240-volt power outlets — no tools required. Choose the plug that fits the receptacle and connect it to the power cord.

14-pin controlled operator alternatives. The standard 14-pin connector on your Multimatic 220 AC/DC lets you choose your control for a customized experience, whether it's a foot control, fingertip control, or wireless foot control.



Optional wireless foot control shown.



Wide range of TIG adjustability.

- AC Balance – adjustable from 60–80%
- AC Frequency – adjustable from 60–150 Hz
- DC Pulse – adjustable from Off–150 pulses per second (PPS)
- TIG Post-Flow – adjustable from Auto–25 seconds (accessible through service menu screen 12)
- Lift-Arc™ and high-frequency starts
- Tungsten size selection

Multimatic® 220 AC/DC Package

Comes complete with:

- Power source
- 10 ft. (3 m) MDX™-100 MIG gun
- 13 ft. (4 m) cable electrode holder and 25 mm Dinse-style connector
- 12.5 ft. (3.8 m) Weldcraft™ A-150 (WP-17) TIG torch with 25 mm Dinse-style connector
- 10 ft. (3 m) work cable with clamp and 25 mm Dinse-style connector
- 6.5 ft. (2 m) power cord with MVP™ plugs for 120 V and 240 V
- RFCS-14 HD foot control with 20 ft. (6 m) cord
- Two flow gauge regulators and gas hoses for argon or AR/CO₂ mix
- Hobart® spool of .030 in. (0.8 mm) solid wire
- Two contact tips for .030 in. (0.8 mm) wire
- Quick Select™ drive roll for .024 in. (0.6 mm) or .030/.035 in. (0.8/0.9 mm) solid wire, and .030/.035 in. (0.8/0.9 mm) flux-cored wire
- AK2C TIG torch accessory kit
- Material thickness gauge ▶ 229895
- Hook-and-loop cord wraps

Note: Shielding gas and safety equipment not included.



Specifications (Subject to change without notice.)



Welding Mode/ Process	Input Power	Welding Amperage Range	Rated Output	Amps Input at Rated Output, 50/60 Hz				Wire Feed Speed	Max. Open-Circuit Voltage	Dimensions	Net Weight
				120 V	240 V	KVA	KW				
CV: MIG/ flux-cored	120 V	30–125 A	105 A at 19.2 V, 60% duty cycle	23.3	—	2.8	2.8	60–600 ipm (1.5–15.2 m/min.)	45 VDC	H: 17.5 in. (445 mm) W: 11.25 in. (286 mm) D: 21.5 in. (546 mm)	56 lb. (25.3 kg)
	240 V	30–230 A	200 A at 24 V, 20% duty cycle	—	27.2	4.8	4.8				
			170 A at 21.5 V, 40% duty cycle	—	21.5	3.8	3.8				
CC: TIG	120 V	20–140 A	130 A at 15.2 V, 40% duty cycle	24.0	—	2.9	2.9	—	46 VDC		
	240 V	20–210 A	210 A at 18.4 V, 20% duty cycle	—	22.4	5.4	5.4				
CC: Stick	120 V	30–90 A	90 A at 23.6 V, 40% duty cycle	24.5	—	2.9	2.9				
	240 V	30–200 A	200 A at 28.4 V, 15% duty cycle	—	31.3	7.5	7.5				

Certified by Canadian Standards Association to both the Canadian and U.S. Standards.

Performance Data

MIG Duty Cycle Chart

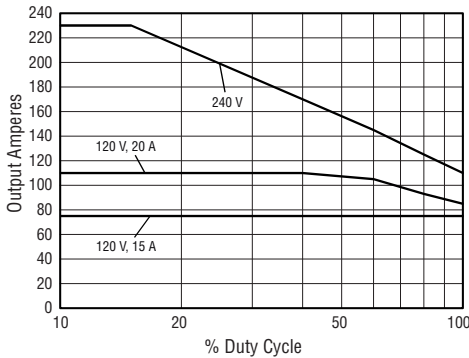

TIG Duty Cycle Chart

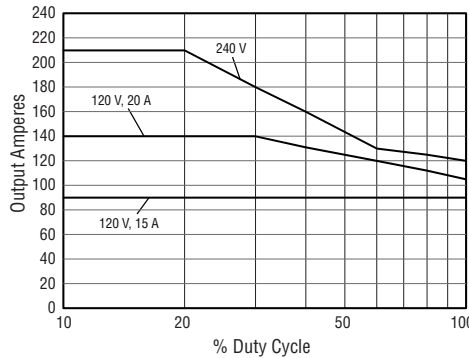

Stick Duty Cycle Chart

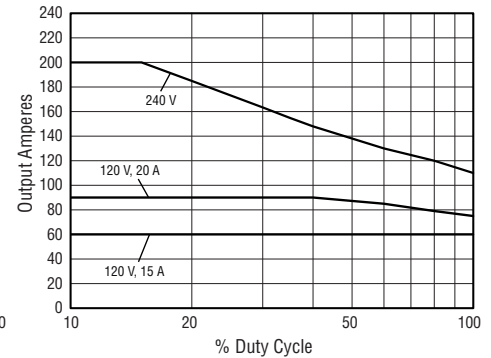

Control Panel

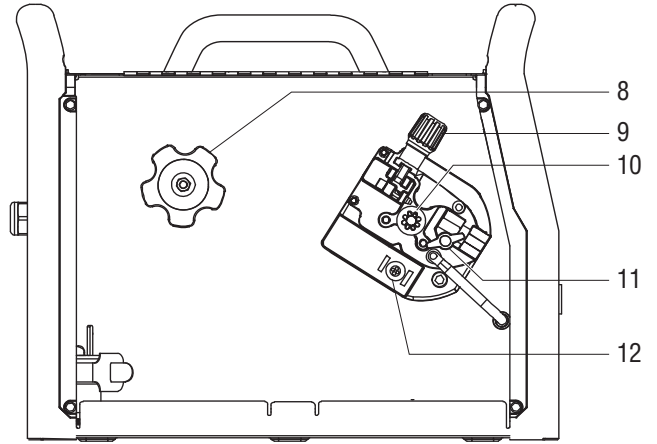
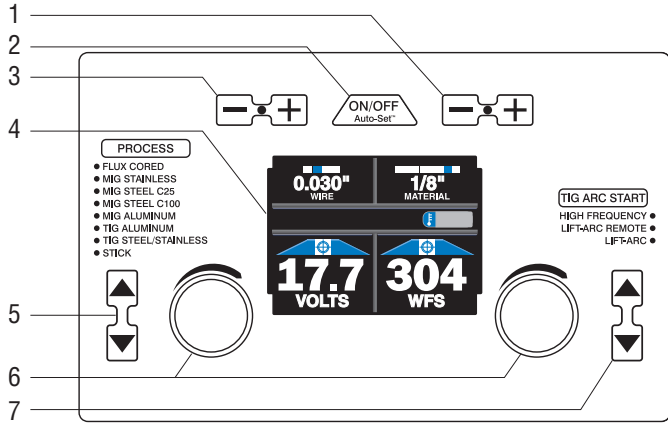

1. Material Thickness Buttons
2. Auto-Set™ Button
3. Wire/Rod/Tungsten Buttons
4. LCD Display Panel
5. Process Buttons
6. Adjustment Knobs

7. TIG Arc Start Buttons
(Lift-Arc™ not available for TIG aluminum)
8. Plastic Hub with Retaining Ring
for 8-inch Spools (shaft also accepts
4-inch spools)

9. Calibrated Tension Knob
10. Drive Roll
11. Gun Securing Knob
12. Four-pin Trigger Control Cable
Receptacle

Note: Power switch and gas solenoid are on power source rear panel.

TIG Aluminum Manual Mode

Note: Button and knob functions change in TIG manual modes from the main panel above.

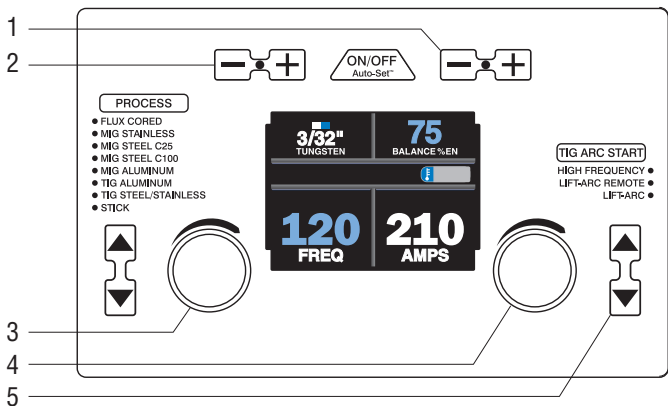

1. Balance Adjustment Buttons (Pro-Set™ 75%)
2. Tungsten Size Buttons
3. Frequency Adjustment Knob (Pro-Set™ 120 Hz)
4. Amperage Adjustment Knob
5. TIG Arc Start Buttons
(Lift-Arc™ not available for TIG aluminum)

TIG Steel/Stainless Manual Mode

Note: Button and knob functions change in TIG manual modes from the main panel above.

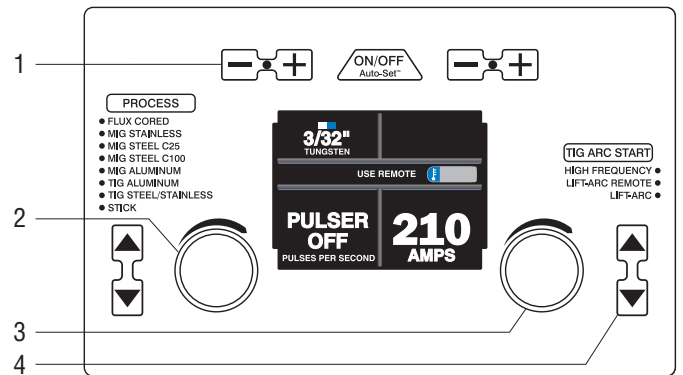

1. Tungsten Size Buttons
2. Pulse Adjustment Knob (Pro-Set™ 100 PPS)
3. Amperage Adjustment Knob
4. TIG Arc Start Buttons

Genuine Miller® Accessories



MDX™-100 MIG Gun 1770028
100-amp MIG gun with Miller® AccuLock™ MDX consumables for .030–.035 in. (0.8–0.9 mm) wire. Includes 10 ft. (3 m) cable assembly.



Spoolmate™ 100 Spool Gun 300371
Direct-connect spool gun handles .030–.035 inch (0.8–0.9 mm) aluminum (4043 only) and .023–.035 inch (0.6–0.9 mm) steel/stainless steel wires. Rated at 135 amps, 30 percent duty cycle. Includes 12-foot (3.7 m) cable assembly and custom carrying case.



Spoolmate™ 150 Spool Gun 301272
Direct-connect spool gun handles .030–.035 inch (0.8–0.9 mm) 4000/5000 series aluminum and .023–.035 inch (0.6–0.9 mm) steel/stainless steel wires. Rated at 150 amps, 60 percent duty cycle. Includes 20-foot (6.1 m) cable assembly.



Weldcraft™ A-150 (WP-17) TIG Torch WP1712RDI25 (12.5 ft.)
150-amp air-cooled torch with 25 mm flow-through Dinse-style connector.



AK2C Accessory Kit
Includes one short back cap, one of each size (#4, #5, #6) alumina nozzle, and one of each size (.040, 1/16, 3/32 inch) of the following: collet, collet body, and 7-inch 2% ceriated tungsten electrode.



TIG Torch Accessory Kit AK-150MFC
Allows welding operators to customize their standard Weldcraft™ A-150 (WP-17) TIG torch for their specific application. Kit converts into 28 different torch styles while using the existing cable. Features nozzles, collets, collet bodies, torch heads, handle and more.



Protective Cover 301524



Dual Cylinder Rack Cart 951770
Package consists of both running gear/cylinder rack 301239 and dual cylinder rack conversion kit 301454. Cart features durable construction with rubber rear wheels, convenient front handles, cable holders, plastic consumable box, and dual cylinder rack with tool holder. Holds two cylinders, each gas cylinder should be no greater than 7 inches (178 mm) in diameter or 65 pounds (29.5 kg) in weight.

MVP™ Plugs



219258
For power cable 6-50P (240 V/50 A). Included with machine.



219261
For power cable 5-15P (120 V/15 A). Included with machine.



219259
For power cable 5-20P (120 V/20 A). Optional, not included with machine.

Remote Controls



Wireless Remote Foot Control 300429
For remote current and contactor control. Receiver plugs directly into the 14-pin receptacle of Miller machine. 90-foot (27.4 m) operating range.



RFCS-14 HD Foot Control 194744
Maximum flexibility is accomplished with a reconfigurable cord that can exit the front, back or either side of the pedal. Foot pedal provides remote current and contactor control. Includes 20-foot (6 m) cord and 14-pin plug.



RCC-14 Remote Contactor and Current Control 151086
East/west rotary-motion fingertip control attaches to TIG torch using two hook-and-loop fasteners. Includes 26.5-foot (8 m) control cord and 14-pin plug.



RCCS-14 Remote Contactor and Current Control 043688
North/south rotary-motion fingertip control attaches to TIG torch using two hook-and-loop fasteners. Includes 26.5-foot (8 m) control cord and 14-pin plug.

Consumables

For MDX™-100 MIG Gun

Miller® AccuLock™ MDX Consumables
Smaller consumables and components to access hard-to-reach weldments.

Contact Tips (10 per package)

T-M023	.023 in. (0.6 mm)
T-M030	.030 in. (0.8 mm)
T-M035	.035 in. (0.9 mm)
T-M045	.045 in. (1.2 mm)
T-M047	3/64 in. (1.2 mm)

Nozzles

NS-M1200B	Brass, 1/2 in. ID, flush
NS-M1200C	Copper, 1/2 in. ID, flush
NS-MFLX	Gasless nozzle

Diffuser D-M100

Monocoil Replacement Liners (10 ft.)

LM1A-10	.023/.025 in. (0.6 mm)
LM2A-10	.030/.035 in. (0.8/0.9 mm)
LM3A-10	.035/.045 in. (0.9/1.2 mm)

Note: Miller® FasTip™, M-Series and Bernard Centerfire™ diffusers and consumables are NOT compatible with MDX Series guns.

For Spoolmate™ 100 Spool Gun



Contact Tips (5 per package)

199730	.024 in. (0.6 mm)
186419	.030 in. (0.8 mm)
186406	.035 in. (0.9 mm)



Nozzle 186405

For Spoolmate™ 150 Spool Gun



Contact Tips (5 per package)

199387	.030 in. (0.8 mm)
199388	.035 in. (0.9 mm)

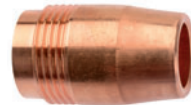

Nozzle 050622

For Both Spool Guns



Drive Roll (1) 186413
For .030/.035-inch (0.8/0.9 mm) wire.



Push Roll (1) 186414
For .030/.035-inch (0.8/0.9 mm) wire.

For Multimatic® 220 AC/DC



Quick Select™ Drive Roll 261157

For .024-inch (0.6 mm) or .030/.035-inch (0.8/0.9 mm) solid wire, and .030/.035-inch (0.8/0.9 mm) flux-cored wire.

V-Knurled Dual-Groove Drive Roll 202926

For .030/.035-inch (0.8/0.9 mm) or .045-inch (1.2 mm) flux-cored wire.

Ordering Information

Power Source and Options	Stock No.	Description	Qty.	Price
Multimatic® 220 AC/DC	907757	120/240 V, 50/60 Hz		
Guns				
MDX™-100 Gun	1770028	10 ft. (3 m), .030–.035 in (0.8–0.9 mm) wire		
Spoolmate™ 100 Spool Gun	300371	12 ft. (3.7 m). Includes custom carrying case		
Spoolmate™ 150 Spool Gun	301272	20 ft. (6.1 m)		
Accessories				
Weldcraft™ A-150 (WP-17) TIG Torch	WP1712RDI25	12.5 ft. (3.8 m) cable		
TIG Torch Accessory Kits	AK2C	For use with Weldcraft™ A-150 (WP-17) Torch		
	AK-150MFC	For use with Weldcraft™ A-150 (WP-17) Torch		
Protective Cover	301524			
Dual Cylinder Rack Cart	951770	Includes running gear/cylinder rack 301239 and dual cylinder rack conversion kit 301454. Must be assembled together		
MVP™ Plugs		See page 6		
Material Thickness Gauge	229895			
Replacement Screen Cover	271493	Replacement cover for LCD display panel		
Flow Gauge Regulator for Argon or AR/CO ₂ Mix	31-50-580-6	Replacement standard regulator		
Flow Gauge Regulator for CO ₂	31-50-320	Required if using 100 percent CO ₂ gas		
Remote Controls				
Wireless Remote Foot Control	300429	Foot control with wireless 90 ft. (27.4 m) operating range		
RFCS-14 HD	194744	Heavy-duty foot control (included with TIG kit and TIG package)		
RCC-14	151086	Fingertip control		
RCCS-14	043688	Fingertip control		
Consumables				
Contact Tips		See page 7		
Nozzles		See page 7		
Diffuser		See page 7		
Monocoil Replacement Liners		See page 7		
Drive Rolls		See page 7		

Date:

Total Quoted Price:

Distributed by:

