

Multimatic® 215

MIG/Multiprocess Power Source,
Wire Feeder and Gun Package



Quick Specs

Light Industrial Applications

Light fabrication
Maintenance and repair
Auto body
Farm/home

Processes

MIG (GMAW)
Flux-cored (FCAW)
DC TIG (GTAW)
DC stick (SMAW)

Weld Thickness

MIG: 24 ga.–3/8 in. steel, 18 ga.–3/8 in. aluminum
TIG: 24 ga.–1/4 in. steel
Stick: 16 ga.–3/8 in. steel

Input Power 120 or 240 V, single-phase, 50/60 Hz

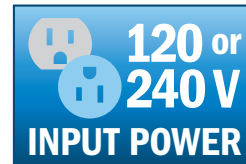

Uses 120- or 240-volt power



Portable

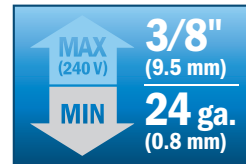

MIG weld capacity



Quick and easy setup

Multiprocess capabilities allow for MIG, flux-cored, DC TIG and DC stick welding.

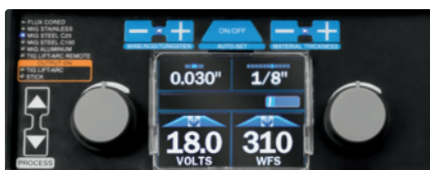

Intuitive color LCD user interface makes it quick and easy to adjust parameters.

Auto-Set™ Elite can be used on multiple materials and multiple processes with the ability to fine-tune your settings. Easy to set up and use.

Multi-voltage plug (MVP™) allows connection to common 120- and 240-volt power receptacles without the use of any tools—choose the plug that fits the receptacle and connect it to the power cord.

Angled cast-aluminum drive system with Quick Select™ drive roll for smooth feeding and quick wire changes.

Smooth-Start™ for consistently smooth, spatter-free MIG starts.

Auto Spool Gun Detect™ automatically detects when a MIG gun or spool gun is connected, eliminating the need for a switch.

Fan-On-Demand™ cooling system only operates when needed, reducing noise, energy use and the amount of contaminants pulled through the machine.

Thermal overload protection automatically shuts down the power source if airflow through the unit is blocked or the duty cycle is exceeded.



Welder is warranted for three years, parts and labor.
Gun warranted for 90 days, parts only.

Comes complete with:

- Power source
- 10 ft. (3 m) MDX™-100 MIG gun
- 13 ft. (4 m) cable electrode holder and 25 mm Dinse-style connector
- 10 ft. (3 m) work cable with clamp and 25 mm Dinse-style connector
- 6.5 ft. (2 m) power cord with MVP™ plugs for 120 V and 240 V
- Flow gauge regulator and gas hose for argon or AR/CO₂ mix
- Hobart® spool of .030 in. (0.8 mm) solid wire
- Two contact tips for .030 in. (0.8 mm) wire
- Quick Select™ drive roll for .024 in. (0.6 mm) or .030/.035 in. (0.8/0.9 mm) solid wire, and .030/.035 in. (0.8/0.9 mm) flux-cored wire
- Material thickness gauge ▶ 229895
- Hook-and-loop cord wraps

Note: Shielding gas and safety equipment not included.



Miller Electric Mfg. LLC
An ITW Welding Company
1635 West Spencer Street
P.O. Box 1079
Appleton, WI 54912-1079 USA

Equipment Sales US and Canada
Phone: 866-931-9730
FAX: 800-637-2315
International Phone: 920-735-4554
International FAX: 920-735-4125

MillerWelds.com
f t y i n



Specifications (Subject to change without notice.)



Welding Mode/Process	Input Power	Welding Amperage Range	Rated Output	Amps Input at Rated Output, 50/60 Hz				Wire Feed Speed	Max. Open-Circuit Voltage	Dimensions	Net Weight
				120 V	240 V	KVA	KW				
CV: MIG/flux-cored	120 V	30–125 A	110 A at 19.5 V, 60% duty cycle	23	—	2.8	2.8	60–600 ipm (1.5–15.2 m/min.)	58 VDC	H: 12.5 in. (318 mm) W: 11.25 in. (286 mm) D: 20.5 in. (521 mm)	38 lb. (17.2 kg)
	240 V	30–230 A	200 A at 24 V, 20% duty cycle	—	25.8	6.2	6.2				
			150 A at 21.5 V, 40% duty cycle	—	16.7	4.0	4.0				
CC: TIG	120 V	20–150 A	140 A at 15.6 V, 40% duty cycle	24.6	—	3	3	—	58 VDC		
	240 V	20–210 A	190 A at 17.6 V, 20% duty cycle	—	18	6.7	6.7				
CC: Stick*	120 V	30–100 A	90 A at 23.6 V, 40% duty cycle	22.7	—	2.7	2.7				
	240 V	30–200 A	190 A at 27.6 V, 20% duty cycle	—	27	6.5	6.5				

*Not recommended for 6010 electrodes.

Certified by Canadian Standards Association to both the Canadian and U.S. Standards.

Control Panel

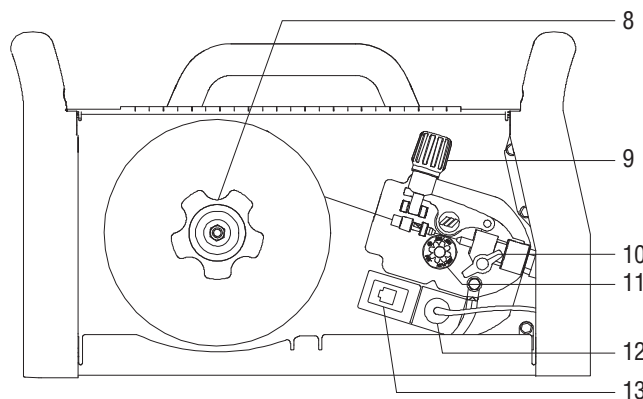
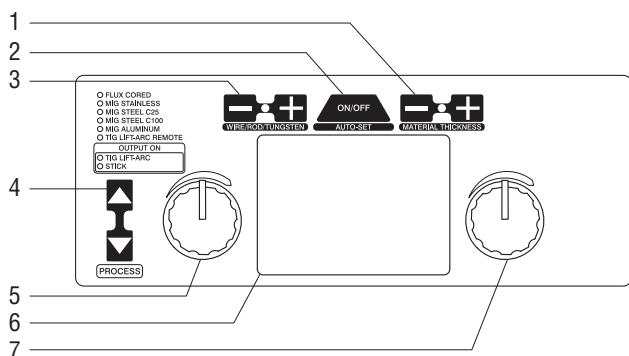

- 1. Material Thickness Buttons
- 2. Auto-Set™ Button
- 3. Wire/Tungsten Diameter and Stick Rod Type Buttons
- 4. Process Selection Buttons
- 5. Adjustment Knob
- 6. LCD Display Panel
- 7. Adjustment Knob
- 8. Plastic Hub with Retaining Ring for 8-inch Spools (shaft also accepts 4-inch spools)
- 9. Calibrated Tension Knob
- 10. T-Knob (secures gun)
- 11. Drive Roll
- 12. Trigger Control Connector
- 13. RJ45 Port (TIG Remote)

Note: Power switch and gas solenoid are on power source rear panel.

Performance Data

MIG Duty Cycle Chart

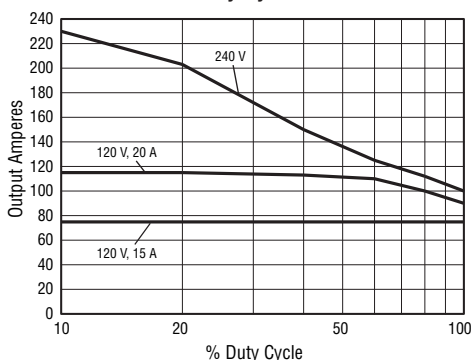

TIG Duty Cycle Chart

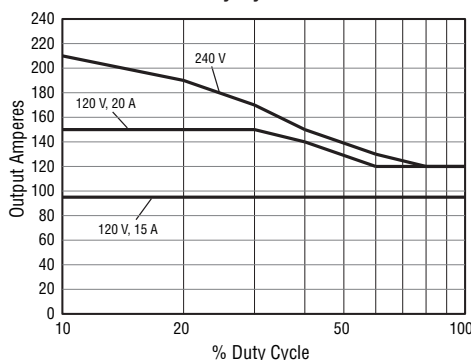

Stick Duty Cycle Chart

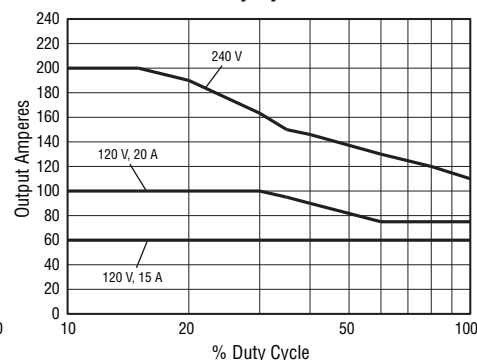

Genuine Miller® Accessories



MDX™-100 MIG Gun 1770028

MDX™-250 MIG Gun 1770035

100-amp or 250-amp MIG gun with Miller® AccuLock™ MDX consumables for .030–.035 in. (0.8–0.9 mm) wire. Includes 10 ft. (3 m) cable assembly.

- Install AccuLock contact tips with a single turn.
- AccuLock liner locks at front and back of gun to align with contact tip and power pin for a flawless wire feed path.
- Durable, ergonomic handle with overmolding improves grip and comfort.
- Ball-and-socket handle with rear swivel for increased gun maneuverability while reducing welder fatigue.



Spoolmate™ 100 Spool Gun 300371

Direct-connect spool gun handles .030–.035 inch (0.8–0.9 mm) aluminum (4043 only) and .023–.035 inch

(0.6–0.9 mm) steel/stainless steel wires. Rated at 135 amps, 30 percent duty cycle. Includes 12-foot (3.7 m) cable assembly and custom carrying case.



Spoolmate™ 150 Spool Gun 301272

Direct-connect spool gun handles .030–.035 inch (0.8–0.9 mm) 4000/5000 series

aluminum and .023–.035 inch (0.6–0.9 mm) steel/stainless steel wires. Rated at 150 amps, 60 percent duty cycle. Includes 20-foot (6.1 m) cable assembly.



TIG Contractor Kit 301337

Kit comes complete with everything needed to TIG weld with the Multimatic 215. Includes Weldcraft™ A-150 TIG torch with flow-through Dinse-style connector, RFCS-RJ45 foot control, flow gauge regulator with 12-foot (3.7 m) gas hose, and AK2C torch accessory kit.

Weldcraft™ A-150 (WP-17) TIG Torch WP1712RDI25 (12.5 ft.)

150-amp air-cooled torch with 25 mm flow-through Dinse-style connector.

AK2C Accessory Kit

Includes one short back cap, one of each size (#4, #5, #6) alumina nozzle, and one of each size (.040, 1/16, 3/32 inch) of the following: collet, collet body, and 7-inch 2% ceriated tungsten electrode.



RCCS-RJ45 Remote Contactor and Current Control 301146

North/south rotary-motion fingertip current and contactor control attaches to TIG torch using two hook-and-loop fasteners. Includes 13.25-foot (4 m) cord with plug.

RJ45 to 14-Pin Adapter Cord 300688

12-inch (305 mm) cord adapts RJ45 port to a 14-pin plug.



Dual Cylinder Rack Cart 951770

Package consists of both running gear/cylinder rack 301239 and dual cylinder rack conversion kit 301454. Cart features durable construction with

rubber rear wheels, convenient front handles, cable holders, plastic consumable box, and dual cylinder rack with tool holder. Holds two cylinders, each gas cylinder should be no greater than 7 inches (178 mm) in diameter or 65 pounds (29.5 kg) in weight.



Protective Cover 301262

Consumables

For MDX™-100 and MDX™-250 MIG Guns

Miller® AccuLock™ MDX Consumables

Smaller consumables and components to access hard-to-reach weldments.

Contact Tips (10 per package)

T-M023	.023 in. (0.6 mm)
T-M030	.030 in. (0.8 mm)
T-M035	.035 in. (0.9 mm)
T-M045	.045 in. (1.2 mm)
T-M047	3/64 in. (1.2 mm)

MDX-100 Nozzles

NS-M1200B	Brass, 1/2 in. ID, flush
NS-M1200C	Copper, 1/2 in. ID, flush
NS-MFLX	Gasless nozzle

MDX-250 Nozzles

N-M1200C	Copper, 1/2 in. ID, flush
N-M1218C	Copper, 1/2 in. ID, 1/8 rec.
N-M5800C	Copper, 5/8 in. ID, flush
N-M5818C	Copper, 5/8 in. ID, 1/8 rec.
N-M58XTC	Copper, 5/8 in. ID, 1/8 ext.

Diffusers

D-M100	MDX-100
D-M250	MDX-250

Monocoil Replacement Liners (10 ft.)

LM1A-10	.023/.025 in. (0.6 mm)
LM2A-10	.030/.035 in. (0.8/0.9 mm)
LM3A-10	.035/.045 in. (0.9/1.2 mm)

Note: Miller® FasTip™, M-Series and Bernard Centerfire™ diffusers and consumables are NOT compatible with MDX Series guns.

For Spoolmate™ 100 Spool Gun

	Contact Tips (5 per package)
	199730 .024 in. (0.6 mm)
	186419 .030 in. (0.8 mm)
186406 .035 in. (0.9 mm)	



Nozzle 186405

For Spoolmate™ 150 Spool Gun

	Contact Tips (5 per package)
	199387 .030 in. (0.8 mm)
199388 .035 in. (0.9 mm)	



Nozzle 050622

For Both Spool Guns



Drive Roll (1) 186413
For .030/.035-inch (0.8/0.9 mm) wire.



Push Roll (1) 186414
For .030/.035-inch (0.8/0.9 mm) wire.

For Multimatic® 215



Quick Select™ Drive Roll 261157
For .024-inch (0.6 mm) or .030/.035-inch (0.8/0.9 mm) solid wire, and .030/.035-inch (0.8/0.9 mm) flux-cored wire.

V-Knurled Dual-Groove Drive Roll 202926

For .030/.035-inch (0.8/0.9 mm) or .045-inch (1.2 mm) flux-cored wire.

Ordering Information

Power Source and Options	Stock No.	Description	Qty.	Price
Multimatic® 215	907693	With 1770028 MDX-100 gun		
Multimatic® 215 with Welding Cart	951000001	907693 packaged with 301239 welding cart		
Multimatic® 215 with TIG Contractor Kit	951674	907693 packaged with 301337 TIG contractor kit		
Guns				
MDX™-100 Gun with AccuLock™ MDX Consumables	1770028	100 A, 10 ft. (3 m), .030–.035 in (0.8–0.9 mm) wire		
MDX™-250 Gun with AccuLock™ MDX Consumables	1770035	250 A, 10 ft. (3 m), .030–.035 in (0.8–0.9 mm) wire		
Spoolmate™ 100 Spool Gun	300371	12 ft. (3.7 m). Includes custom carrying case		
Spoolmate™ 150 Spool Gun	301272	20 ft. (6.1 m)		
Accessories				
TIG Contractor Kit	301337	Includes Weldcraft™ A-150 TIG torch with Dinse-style connector, RFCS-RJ45 foot pedal, flow gauge regulator with 12 ft. (3.7 m) gas hose, and AK2C torch accessory kit		
Weldcraft™ A-150 (WP-17) TIG Torch	WP1712RDI25	12.5 ft. (3.8 m) cable		
Weldcraft™ AK2C Accessory Kit	AK2C	Includes one short back cap, one of each size (#4, #5, # 6) alumina nozzle, and one of each size (.040, 1/16, 3/32 inch) of the following: collet, collet body, and 7-inch 2% ceriated tungsten electrode		
RCCS-RJ45	301146	Remote fingertip current and contactor control		
RJ45 to 14-Pin Adapter Cord	300688	12 in. (305 mm) cord adapts RJ45 port to a 14-pin plug		
Running Gear/Cylinder Rack	301239			
Dual Cylinder Rack Conversion Kit and Tool Holder	301454			
Dual Cylinder Rack Cart	951770	Includes running gear/cylinder rack 301239 and dual cylinder rack conversion kit 301454. Must be assembled together		
Protective Cover	301262			
Material Thickness Gauge	229895			
Replacement Screen Cover	271493	Replacement cover for LCD display panel		
Flow Gauge Regulator for Argon or AR/CO ₂ Mix	31-50-580-6	Replacement standard regulator with gas hose		
Flow Gauge Regulator for CO ₂	31-50-320	Required if using 100 percent CO ₂ gas		
Flux-cored Wire				
Solid Wire				
Consumables				
Contact Tips		See page 3		
Nozzles		See page 3		
Diffusers		See page 3		
Monocoil Replacement Liners		See page 3		
Drive Rolls		See page 3		

Date:

Total Quoted Price:

Distributed by:

