

# RF1

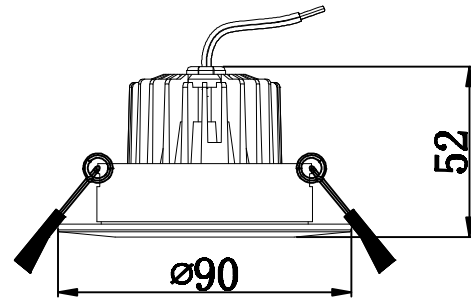

CUT OUT 70-75mm

X2A+RF1

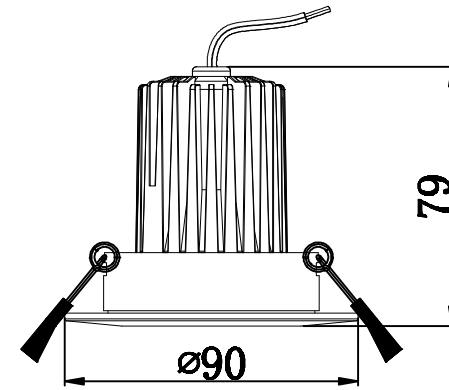

CUT OUT 70-75mm

X3A+RF1

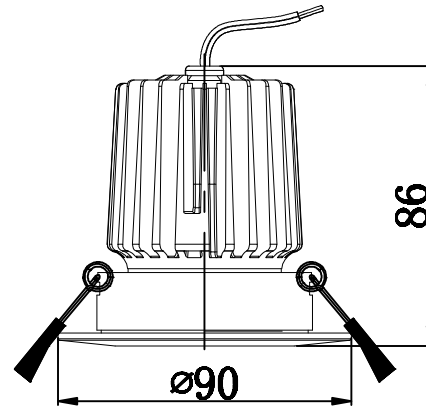

CUT OUT 70-75mm

X15A+RF1