

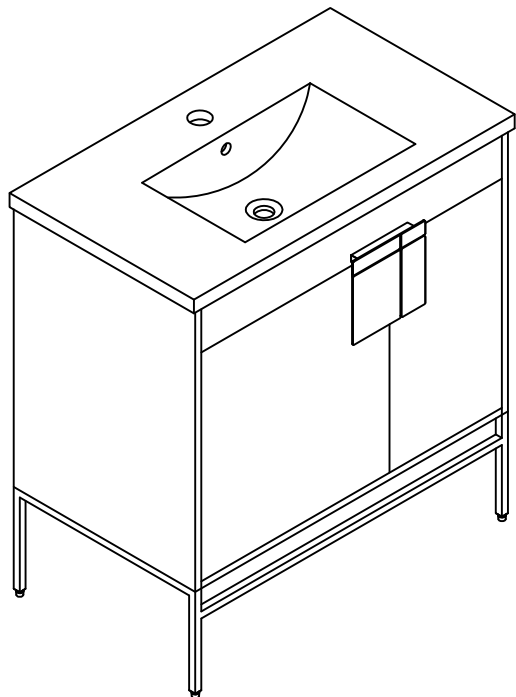



Assembly Instruction

Item No. :CL-102DG-40ZI

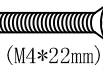
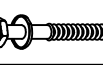

Hardware

NO.	Draw	QTY
A	 (M5*12mm)	8
B	 (4*14mm)	7
C	 (M4*22mm)	8
D		2
E		2
F		2

Tools

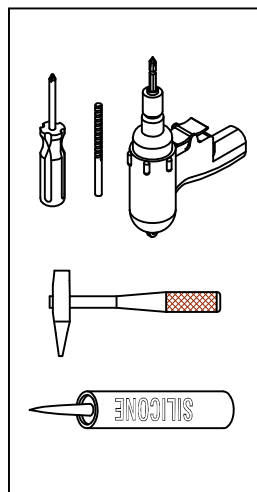

Step 1

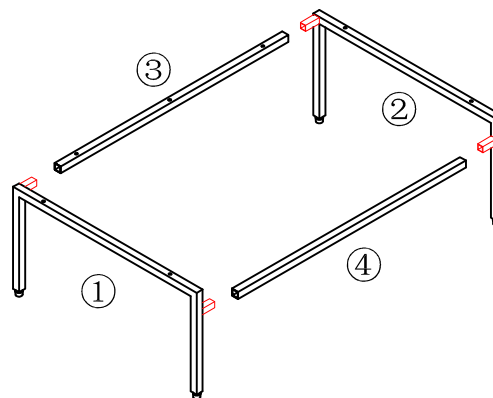

Step 2

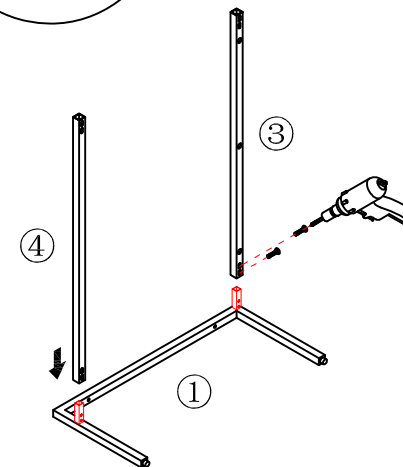
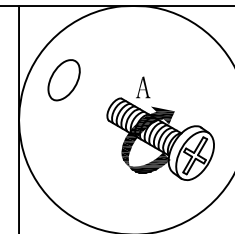

Step 3

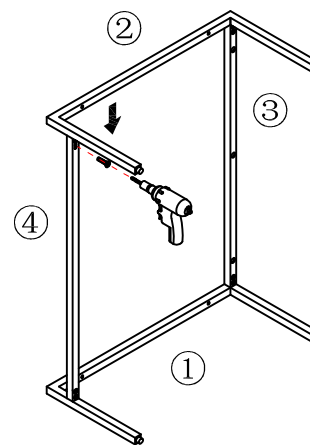
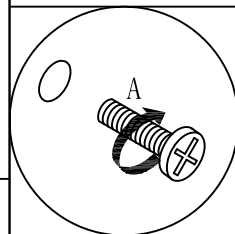

Step 4

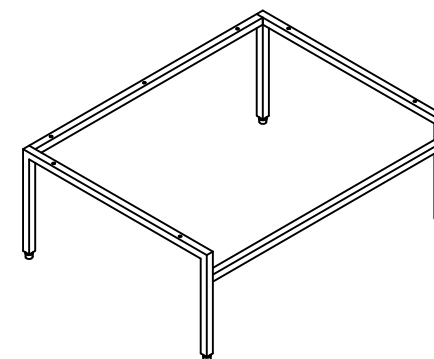

Step 5

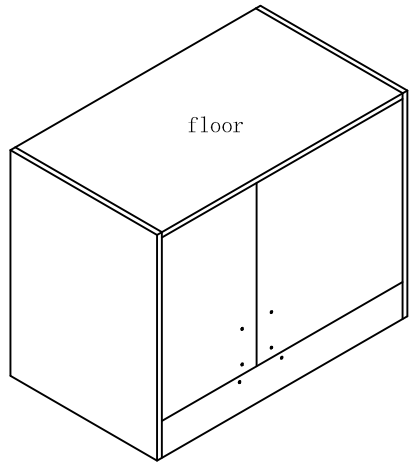

Cabinet handstand

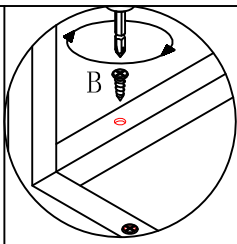

Step 6

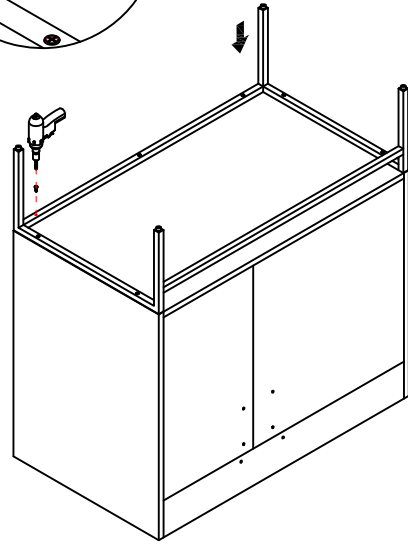

Step 9

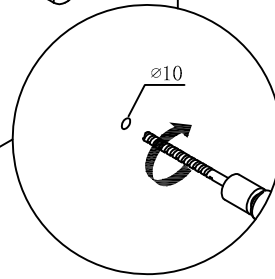
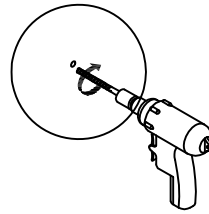

Step 10

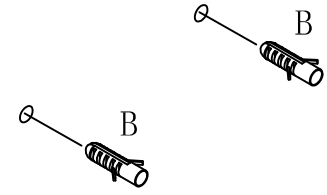

Step 7

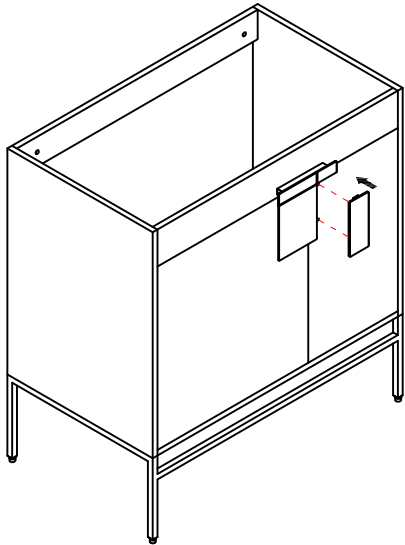

Step 8

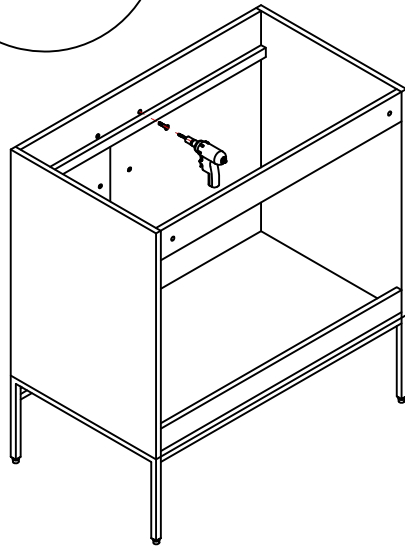
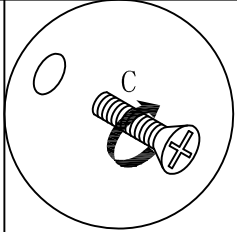

Step 11

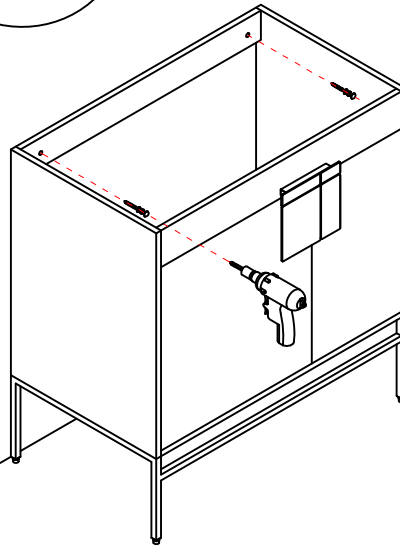
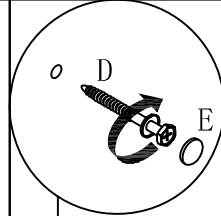

Finished

