

KENWOOD

DRV-N520

Dashboard camera

INSTRUCTION MANUAL

JVCKENWOOD Corporation

For your records

Record the serial number, found on the back of the unit, in the spaces designated on the warranty card, and in the space provided below. Refer to the model and serial numbers whenever you call upon your Kenwood dealer for information or service on the product.

Model DRV-N520

Serial number _____



US Residents Only

Register Online

Register your Kenwood product at www.Kenwoodusa.com

Contents

Precautions and notices.....	3
Precautions for Use.....	4
Accessories	6
Names and Functions of Parts	7
How to Install	8
LED Indications	12
Initial settings	12
Basic Operation	13
Display the Dashboard camera screen	14
Using the Driving Support function.....	16
Recording	19
Protecting or Deleting Files	26
Various Settings	28
Updating the system.....	31
Using the PC Application.....	31
Formatting an SD Card	35
Troubleshooting	36
Specifications.....	40

Disclaimer

- Please note that JVC KENWOOD shall not be responsible for any damages suffered by the customer or a third party as a result of incorrectly using this product, a failure during use of this product, or other trouble, or due to the use of this product, unless such liability is acknowledged by law.

Copyrights

- Recorded video, image, and audio content cannot be used for other than personal enjoyment without the consent of the copyright holder as specified in the Copyright Act.
- Please note that the recording of an event such as a show, performance, or exhibition may be restricted even when doing so for personal enjoyment.

Precautions and notices

- **Warning!** Do not operate the device while driving. Using this product does not change the requirement for a driver to take full responsibility for his or her behavior. This responsibility includes observing all traffic rules and regulations in order to avoid accidents, personal injury or property damage.
- For your own safety, do not operate the controls of the product while driving.
- A window mount is needed when using the recorder in a car. Make sure that you place the recorder in an appropriate place, so as not to obstruct the driver's view or deployment of airbags.
- Make sure that no object is blocking the camera lens and no reflective material is placed near the lens. Please keep the lens clean.
- If the car's windscreen is tinted with a coating, it may impact the recording quality.
- Connect the charger to a proper power source. The voltage requirements are found on the product case and/or packaging.
- Do not use the charger if the cord becomes damaged.
- Do not attempt to service the unit. There are no serviceable parts inside. Replace the unit if it is damaged or exposed to excess moisture.

Caring for your device

- Taking good care of your device will ensure trouble-free operation and reduce the risk of damage.
- Keep your device away from excessive moisture and extreme temperatures.
- Avoid exposing your device to direct sunlight or strong ultraviolet light for extended periods of time.
- Do not place anything on top of your device or drop objects on your device.
- Do not drop your device or subject it to severe shock.
- Do not subject your device to sudden and severe temperature changes. This could cause moisture condensation inside the unit, which could damage your device. In the event of moisture condensation, allow the device to dry out completely before use.
- Never clean your device with it powered on. Use a soft, lint-free cloth to wipe the camera lens and the exterior of your device.
- Do not use paper towels to clean the camera lens.
- Never attempt to disassemble, repair or make any modifications to your device. Disassembly, modification or any attempt at repair could cause damage to your device and even bodily injury or property damage and will void any warranty.
- Do not store or carry flammable liquids, gases or explosive materials in the same compartment as your device, its parts or accessories.
- To discourage theft, do not leave the device and accessories in plain view in an unattended vehicle.
- Overheating may damage the device.

FCC WARNING

This equipment may generate or use radio frequency energy. Changes or modifications to this equipment may cause harmful interference unless the modifications are expressly approved in the instruction manual. The user could lose the authority to operate this equipment if an unauthorized change or modification is made.

FCC NOTE

This equipment has been tested and found to comply with the limits for a Class B digital device, pursuant to Part 15 of the FCC Rules. These limits are designed to provide reasonable protection against harmful interference in a residential installation.

This equipment may cause harmful interference to radio communications, if it is not installed and used in accordance with the instructions. However, there is no guarantee that interference will not occur in a particular installation. If this equipment does cause harmful interference to radio or television reception, which can be determined by turning the equipment off and on, the user is encouraged to try to correct the interference by one or more of the following measures:

- Reorient or relocate the receiving antenna.
- Increase the separation between the equipment and receiver.
- Connect the equipment into an outlet on a circuit different from that to which the receiver is connected.
- Consult the dealer or an experienced radio/TV technician for help.

Precautions for Use

Precautions for Installation

- Install the device in a position where it will not block the front view of the driver (position where hidden by the rear-view mirror).
- Install the device so that it is within the wiping range of the wiper.
- Install the device in a position where it will not interfere with the movement of the rear-view mirror.
- Take care not to install the device over the vehicle inspection sticker or other sticker.
- Take care not to install the device where it will interfere with driving or airbag operation.
- When installing the device in a vehicle equipped with a driving support system, check the instruction manual of the vehicle and then select an installation location that will not interfere with the driving support system.
- If the device is installed incorrectly, event recording or parking recording may not work correctly. Refer to "How to Install" for the loosening of fixing knob, installation orientation, installation angle, and other information and then install the device correctly.(P.8)
- Do not install the device near an electrical component. Doing so may cause flickering and noise.
- Use a commercially available cleaning cloth or the like to wipe off all dirt and grease on the mounting surface and then fix the mount base in place. If the device is re-affixed or mounted using, for example, general-purpose double-sided tape, the adhesion strength may weaken and cause the device to fall.
- After mounting the device, leave it for 24 hours before use to enable the mounting strength of the mount

bracket to improve. Failing to do so may result in the adhesion of the mount bracket becoming weak and the device falling.

- Fix the cord in place with tape or the like so that it does not interfere with driving.

Precautions for Use

- Do not block the camera lens, get dirt on it, or place a reflective object near it.
- When LED traffic lights are recorded, video in which they appear to be flickering or flashing may be recorded. JVC KENWOOD assumes no responsibility with regard to the distinguishing or recording of traffic lights.
- If coating is used on the windshield of the vehicle, recording quality may be affected.
- There is no guarantee that the device can record video in all conditions.

Cleaning the Device

- When the device is dirty, wipe it with a dry silicone cloth or other soft cloth. If the device is very dirty, remove the dirt with a cloth with neutral cleaner on it and then wipe off the cleaner. Wiping the device with a hard cloth or using a volatile substance such as thinner or alcohol may cause scratches, deformation, deterioration, or other damage.
- When the lens is dirty, gently wipe it with a soft cloth dampened with water. Rubbing the lens strongly with a dry cloth may cause scratches.

If You Notice a Problem with the Device

- If you notice a problem with the device, first refer to "Troubleshooting"(P.36) and check whether there is a way to resolve the problem.
- If you are unable to find a way to resolve the problem, contact your dealer or nearest JVC KENWOOD service center.

SD Cards

- Cards supported by this device

Standard	microSDHC
Capacity	8 GB to 32 GB
Speed class	Class 6 or higher
File system	FAT32

- Up to the Class 10 speed class is supported.

Precautions for using SD cards

- When using a commercially available SD card, also check the instructions supplied with the SD card.
- Be sure to format (initialize) an SD card with the device before use.
- SD cards have a product lifespan, such as the number of times that writing can be performed. It is recommended to replace the SD card with a new one regularly depending on the usage conditions.
- When inserting and removing an SD card, confirm the orientation, do not bend it, and do not apply a strong force or impact to it.
- Do not directly touch the contact part with a hand or metal. The stored data may be damaged or lost due to static electricity.
- Be sure to back up (copy) the required files in the SD card to a PC or other device. The saved data may be lost due to the usage conditions of the SD card. Please note that JVC KENWOOD cannot compensate for any damages arising from the loss of saved files.

Requests Regarding Disposal or Transferring Ownership of an SD Card

- Using the SD card format and deletion functions of this device or formatting with a function of a PC just changes the file management information and does not completely delete the data in an SD card. We recommend either physically destroying the actual SD card or using commercially available PC data deletion software or the like to completely delete the data in the SD card before disposal or transfer of ownership. Manage the data in SD cards at your own responsibility.

Accessories

① Power cord x1



② Mount bracket x1



③ Cable holder x1



④ microSDHC card (8GB) x1



Names and Functions of Parts

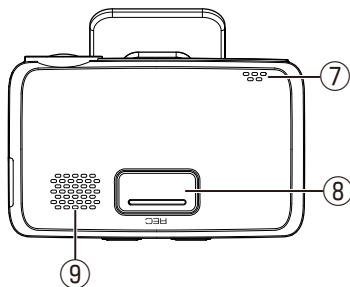
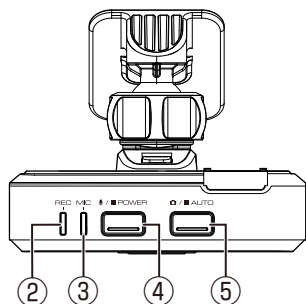
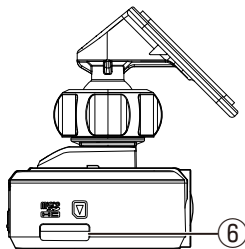
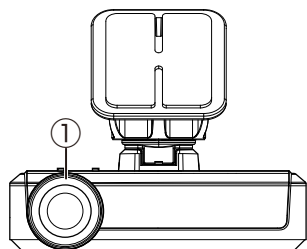

① **Camera lens**

② **REC LED**

Lights (blue) while recording is in progress.

③ **MIC LED**

Lights (green) when audio recording is turned on.

④ **POWER button**

- Audio recording toggles between enabled and disable states each time this button is pressed.
- Hold down this button to turn on or off the power of the device.

⑤ **AUTO button**

- Take a photo.
- The automatic still image capture function turns on automatically when this button is pressed and held. The automatic still image capture function turns off when the button is pressed and held while the function is turned on.

⑥ **microSD card slot**

Insert an SD card for recording.

⑦ **Microphone**

Records audio.

⑧ **REC button**

Start manual recording.

⑨ **Speaker**

Outputs voice guidance, warning sounds, and file playback audio.

Note

- When a recorded file is played on navigation, the audio is output from the speaker of this device, not from the navigation speaker.

How to Install

Installation Procedure

Check that the vehicle is parked on a level surface.

1. Attach the device to the mount bracket (accessory) ②.

Insert the mount bracket into the bracket attachment part of the device and attach it to the device.

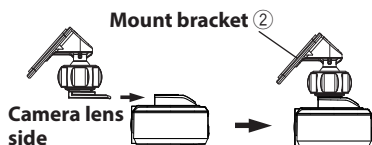

2. Determine where to mount the device.

Determine the mounting position in reference to "Recommended installation position".

3. Clean the mounting surface and then affix the device to the windshield.

Use a commercially available cleaning cloth or the like to wipe off all dirt and grease on the mounting surface. Peel off the release paper of the double-sided tape on the mount bracket and push the bracket against the windscreen to affix it in place. Leave the device for 24 hours before use to enable the mounting strength of the mount bracket to improve.

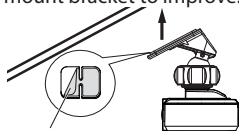

Release paper

4. Perform the cord wiring work.

Refer to "How to Wire" and then perform the wiring work.(P.10)

5. Adjust the installation angle of the device and then fix the device in place.

Turn the angle adjustment knob clockwise before adjustment. Adjust the sky portion and the road portion to 50:50 as shown in the picture below. After adjusting the installation angle, turn the angle adjustment knob of the adjustment bracket counterclockwise to fix the device in place.

■ Adjustment example

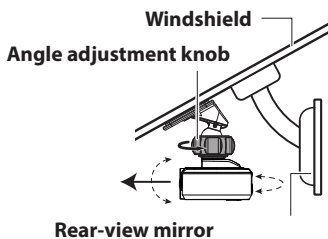
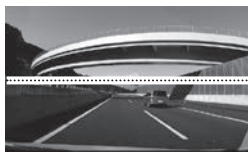

6. Adjusting the Settings to Match the Vehicle

- Settings are required to use the driving support function.(P.16) The driving support function will not work without configuring these settings properly.
- Configure the Dashboard camera on the receiver on which the device is connected. For connection information, refer to the instructions supplied with that receiver.

Recommended installation position

- Install the device in a position where it will not block the front view of the driver (position where hidden by the rear-view mirror).
- Install the device so that it is within the wiping range of the wiper.
- Mounting the device to the center of the windshield behind the rear-view mirror will facilitate optimal video recording.

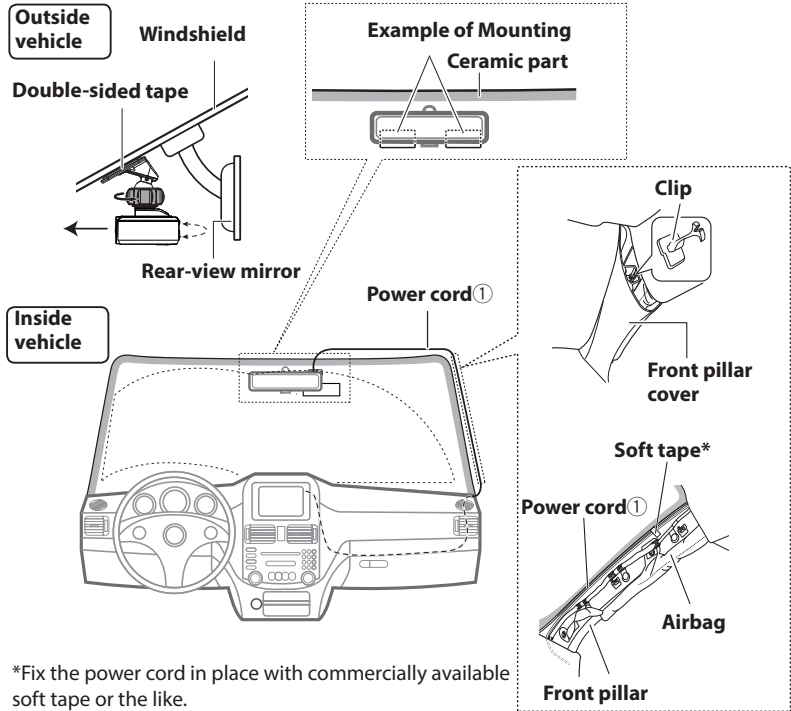

CAUTION

When passing the power cord through the front pillar or another part, observe the following points when performing the wiring work.

- Wire the power cord farther forward or farther rearward than the airbag so that it does not interfere with the airbag.
- In the case of a vehicle in which the front pillar cover is fixed in place with special clips or the like, the clips may need to be replaced after you remove the front pillar cover. For how to remove the front pillar cover, the availability of replacement parts, and other information, contact the vehicle dealer.
- Fix the power cord in place with commercially available soft tape or the like so that it does not interfere with driving.

How to Wire



CAUTION

To prevent a short circuit, remove the key from the ignition and disconnect the  terminal of the battery.

1. Connect the power cord (accessory ①) to the Dashboard camera.

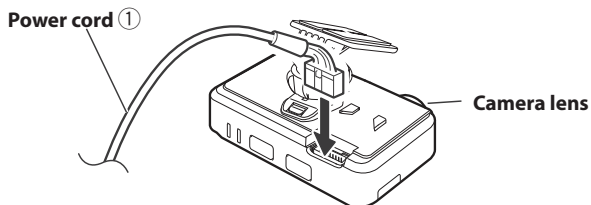

2. Mount the cable holder (accessory ③) in position by inserting it into the slot in the Dashboard camera and also inserting its claw into the connector of the Dashboard camera.

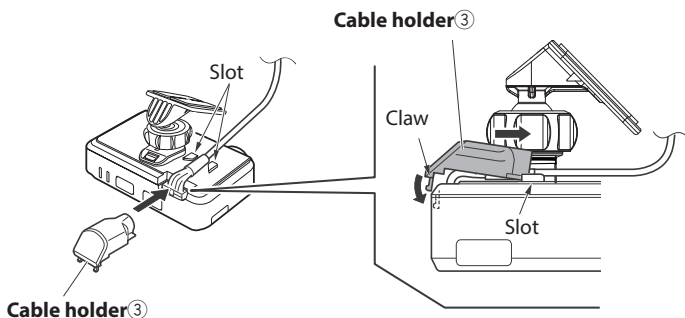

3. Make connections

- Settings are required to connect the Dashboard camera. Refer to the instructions supplied the receiver.
 - For the model having a video input connector with a DASH CAM tag, connect the video output to the Front view camera/Dashboard camera input connector (yellow).
 - For the model that does not have a video input connector with a DASH CAM tag, connect the optionally available CA-C3AV to the AV-IN input port of the receiver, and then connect the video output to the video input connector (yellow) of the CA-C3AV.

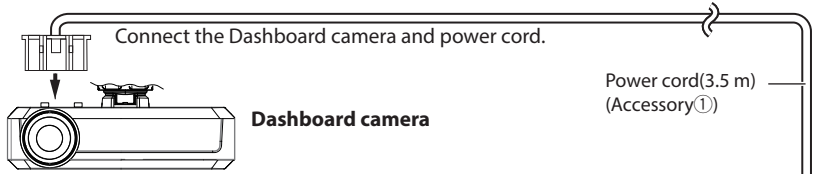

GPS NAVIGATION SYSTEM/ MONITOR WITH RECEIVER

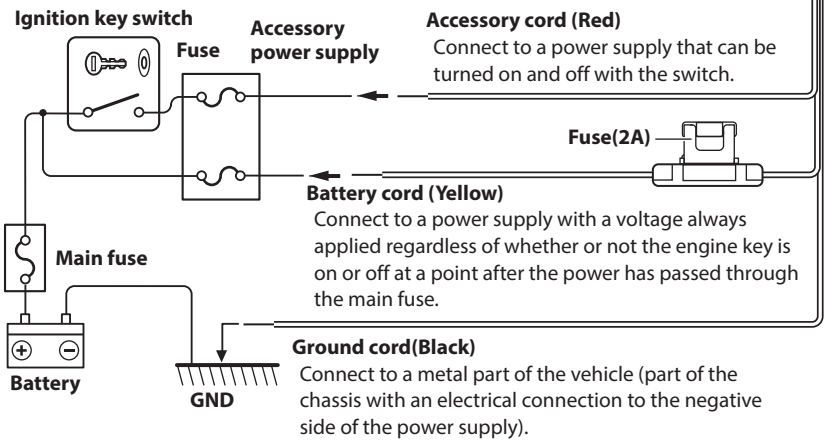
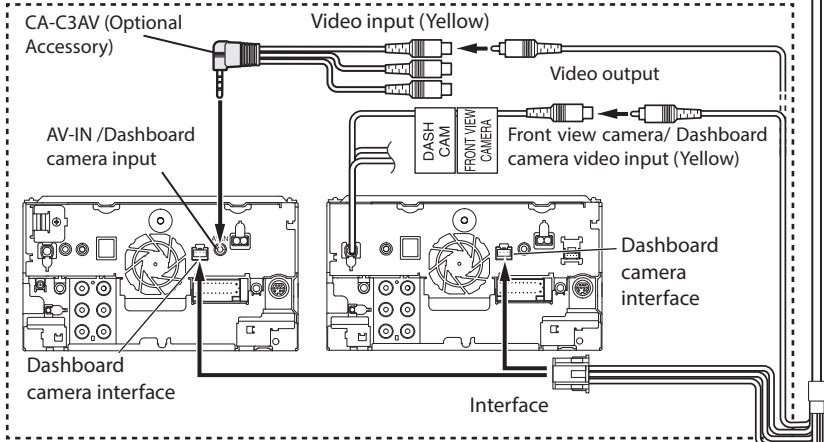

LED Indications

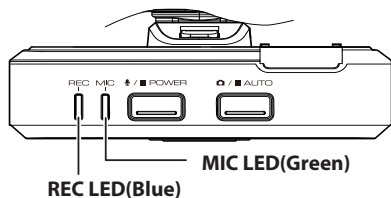

State	LED	
	REC (Blue)	MIC (Green)
starts continuous recording	On	-
stops continuous recording	Off	-
starts manual recording	On	-
starts event recording	On	-
starts parking recording	On	-
stops parking recording	Off	-
Audio recording is enabled.	-	On
Audio recording is disabled.	-	Off

Initial settings

- Set the time zone before use. If you use the driving support function, complete the setting as described on page 16 as well.
- Configure the Dashboard camera in advance using the receiver to which the Dashboard camera is to be connected.

1. Press the [MENU] button on the monitor panel.

2. Touch [Camera].



3. Touch [REC].



Displays the operating buttons on the screen.

4. Touch [Settings].



5. Touch [System Settings].



6. Set the following items.

Item	Explanation
Time Zone	Select the Time Zone. UTC-12:00 to UTC+14:00 UTC+0:00*
Daylight Saving Time	OFF*/+1 hr./+30 min Set daylight saving time.
Time Format	12-Hour/24-Hour*
Date Format	Month/Day/Year / Day/Month/Year* / Year/Month/Day
Notification Volume	0/1/2*/3
Select Units	km /h, MPH*

* Factory default settings

Basic Operation

Inserting and Removing an SD Card

Turn off the power of the device and then insert an SD card into the SD card slot until you hear a clicking sound.

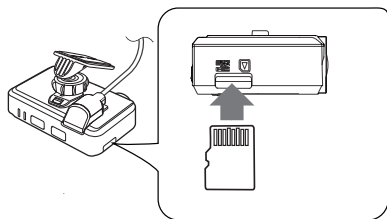

To remove the SD card, turn off the power of the device and then press the SD card so that it pops up and remove the SD card by pulling it out.

Note

- Make sure that the device is powered off (LED off) before mounting or demounting an SD card.
- Have only the data recorded by this device stored on an SD card.
- This device will not be functional without an SD card mounted in position.
- Be sure to format an SD card with the device.

Turning the Power On/Off

Turning on the accessories power (ACC) switch or starting the engine of the vehicle turns on the power of the device and starts continuous recording. When the device is connected using the power code (P.10) turning off the accessories power (ACC) turns off the power of the device and switches to parking recording mode.

To Turn the Power On/Off Manually

When the accessories power (ACC) is on, the power of the device can be turned on or off manually.

- Hold down the [POWER] button for at least 1 second while the device is on to turn off the power.
- Hold down the [POWER] button for at least 1 second while the device is off to turn on the power.

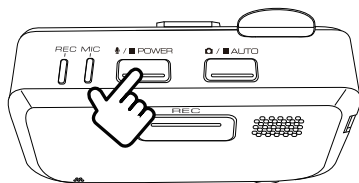

Display the Dashboard camera screen

1. Press the [MENU] button.
2. Touc [Camera].



Display the Dashboard camera screen.



While the rear camera view is displayed, a touch screen is displayed in the upper center of the Dashboard camera screen.









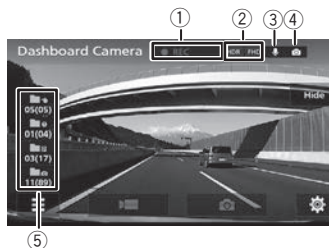

3. Touch .



Displays the operating buttons on the screen.



- 1 **Recording mode/Remaining manual recording or event recording time**
- 2 **HDR recording/Resolution**
- 3 **Audio recording ON /OFF **
- 4 **Automatic still image capture mode ON / OFF **
- 5 **Number of recording files (number of files that can be recorded)**

Button	Explanation
	Configures the Dashboard camera.(P.28)
	Displays a recorded file list.
	<ul style="list-style-type: none"> • Start manual recording. (P.21) • Touch while manual recording is in progress to extend the duration of manual recording.
	<ul style="list-style-type: none"> • Take a photo.(P.22) • Press and hold to turn ON the automatic still image capture function.
[Hide]	Hides the operating buttons on the screen.

Note

- The operating buttons will clear after a certain period of time.

Turn off the Dashboard camera screen

1. Touch the lower center of the screen



Using the Driving Support function

CAUTION

- The driving support function is for providing driving support to drivers and not for preventing accidents. Furthermore, it does not provide notifications of all hazards.
- Please observe the traffic rules to ensure safe driving by paying attention to the distance to the vehicle in front, your surroundings and driving conditions, and applying the brakes when necessary. Furthermore, operation is not completely guaranteed even when the device is used correctly as described in the instruction manual. Please note that JVC KENWOOD bears no responsibility whatsoever for any losses incurred as a result.
- Due to the specifications of the device, a warning sound is also played when you change lanes on roads because the lane departure warning function is not linked to the turn signals.
- The driving support function may not operate correctly in the following cases.
 - Location where GPS signals cannot be received correctly, such as in tunnels or where there are many tall buildings
 - When lanes cannot be correctly recognized as a result of deterioration of the road surface, reflection during rain, etc.
 - When the vehicle in front cannot be recognized as a vehicle due to its shape or paint color, changes in the amount of light, etc.
 - Changes due to weather (rain, snow, heavy fog, etc.), time of day (early hours of the morning, evening, night, etc.), light from behind, and traffic conditions (traffic jams, pedestrians, etc.)

Adjusting the Settings to Match the Vehicle

Before using the driving support function, set the mounting height of the device from the road surface and adjust the horizon and engine hood front edge position settings to match the vehicle.

- Park the vehicle on a place with good visibility, and adjust the angle and orientation of the camera. If the camera is deviated from the correct position, the driving support function will not work properly. After completion of the adjustment, secure the camera firmly.

1. Press the **[MENU]** button.
2. Touch **[Camera]**.



3. Touch **[Camera]**.



Displays the operating buttons on the screen.

4. Touch **[Settings]**.



5. Touch **[Driving Support Settings]**.



6. Touch [Mounting Height Settings].



7. Select the mounting height from the road surface.



8. Touch [Detection Range Settings].

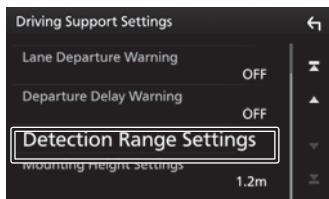

9. Adjust the installation angle.

Turn the angle adjustment knob clockwise before adjustment. For the proper installation of the device, adjust your device to align the white horizontal line with the horizon, and the red vertical line with the center of the driving lane. Also the picture ratio of sky portion to road portion should be 50 to 50 as shown in the picture below.



After adjusting the installation angle, turn the angle adjustment knob of the adjustment bracket.

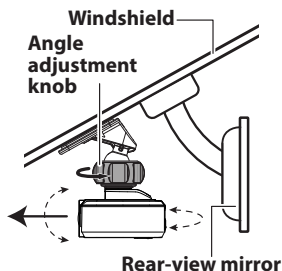

10. Touch [] to adjust the blue point line to the actual horizon using []/[].



11. Touch [] to adjust the white point line to the top of the engine hood using []/[].

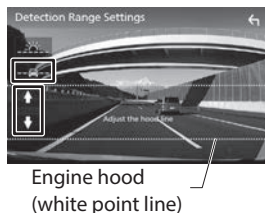

If the top of the engine hood does not show, lower the white point line to the bottom of the screen.

12. Touch [].

Settings the driving support function

1. Touch



2. Touch [Driving Support Settings].



3. Touch items to set.



■ Forward Collision Warning

Detects the distance between your vehicle and the vehicle in front and notifies with a warning sound and a warning sign to prevent a collision with the vehicle in front if a safe distance is not maintained. This operates at 30 km/h and faster.

■ Lane Departure Warning (Except for North America)

Detects the lane your vehicle is driving in and notifies, with a warning sound and a warning sign, when your vehicle is departing from the current lane. This operates at 60 km/h and faster.

■ Departure Delay Warning

When your vehicle is stopped behind the vehicle in front and then the vehicle in front begins moving, notifies you with a warning sound and a warning sign, if your vehicle is late to begin moving.

Function	Warning sound	Warning sign
Forward collision warning	DING... DING... DING...	Collision Warning
Lane departure warning	DING,DING... DING,DING	Lane Departure Warning
Departure delay warning	DING,DING, DING... DING,DING, DING...	Departure Delay Warning

[ON]: Informs you of execution of this function with a warning sound and warning sign.

[ON(Beep Only)]:
Informs you of execution of this function with a warning sound only.

[OFF]: Does not use this function.

Recording

Recording Times

Recording quality	Card capacity		
	8GB	16GB	32GB
3M(2304 x 1296)	50 minutes	100 minutes	210 minutes
1920x1080 / 1920x1080+HDR	70 minutes	140 minutes	280 minutes
1280x720 / 1280x720+HDR	100 minutes	200 minutes	400 minutes

Note

- If you wish to change recording quality, make changes to the setting of [Resolution + HDR Recording](P.29).
- Still images are saved with the same resolution as set by [Resolution + HDR recording] (P.29).
- The above recording times are the totals (maximums) for continuous recordings, manual recordings, event recordings and parking recordings.
- The recording times are estimates. They may become shorter depending on the recording scene.
- The storage capacity cannot be varied from one recording mode to another.

Number of Recording Files

Recording mode	Card capacity		
	8GB	16GB	32GB
Event recording	5 files	10 files	20 files
Manual recording	10 files	20 files	40 files
Parking recording	20 files	40 files	80 files
Still image recording	100 files	200 files	400 files

Overwrite settings

- New event recording, manual recording and parking recording files are saved by overwriting their old files if the [Overwrite] setting has been set to [ON].
Back up important files to a PC or the like beforehand. Your product, when purchased, comes with the [Overwrite] setting set to [OFF] for event and manual recording files and to [ON] for parking recording files.(P.29)
- An [Overwrite] (ON/OFF) setting is not supported for continuous recording.

Recording Modes

The device has five recording modes. Turning on the power of the device starts continuous recording. The recorded video is recorded as files to the SD card. The recording files are sorted into a separate folder for each recording mode.

Note

- The recording modes won't work in any of the following states:
 - No SD card mounted
 - Recording file playing
 - Manual recording files, event recording files or parking recording files already stored up to their maximum capacity limits, so they cannot be overwritten
 - Recording file list on display
 - Setup screen on display

Continuous recordings

Turning on the power of the device starts continuous recording. In continuous recording mode, files are deleted in order from the oldest to record when there is no recording area remaining.

Note

- The recording data is saved to the "NORMAL(Continuous Recordings)" folder.
- The recording time of one file can be set in [Continuous Recording File Length](P.29).

Event recording

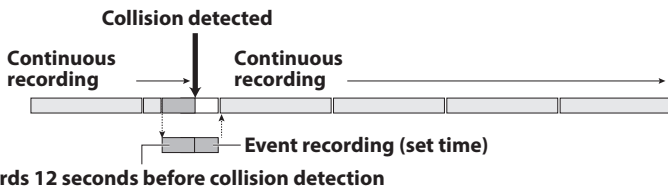

The detection of a sudden collision, unexpected collision, or other event during continuous recording starts event recording. The recording time of event recording is the 12 seconds before collision detection plus the time set in [Event Recording Time](P.29). When event recording ends, the mode returns to continuous recording.



Note

- The recording data is saved to the "EVENT (Event Recordings)" folder.
- The recording time of one file is a maximum of one minute. If the recording time exceeds one minute, the file is split to record.
- If a collision is detected during event recording, event recording is extended.

Manual recording

Pressing the [REC] button on the device or touch [] on the screen during continuous recording starts manual recording. The recording time of manual recording is the 12 seconds before manual recording plus the time set in [Manual Recording Time] (P.29). If you wish to extend the recording time(to the preset time), press the [REC] button or touch [] on the screen again. When manual recording ends, the mode returns to continuous recording.

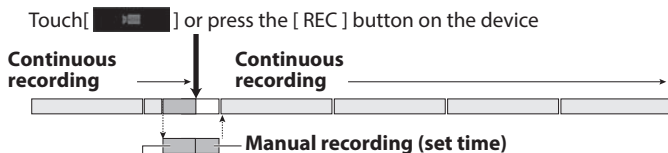
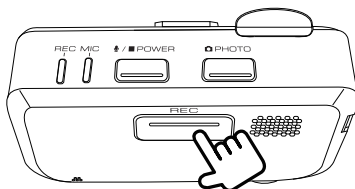

Records 12 seconds before manual recording

Note

- The recording data is saved to the "MANUAL (Manual Recordings)" folder.
- The recording time of one file is a maximum of one minute. If the recording time exceeds one minute, the file is split to record.

Still Image Recording/Automatic Still Image Recording

Pressing the [AUTO] button on the device or [] on the screen during continuous recording allows you to take a photo whenever you wish.

Holding down the [AUTO] button on the device turns ON the automatic still image capture function.

The automatic still image capture function records still images automatically according to the preset count and interval of time.

Holding down the [AUTO] button on the device again turns off the automatic still image capture function.

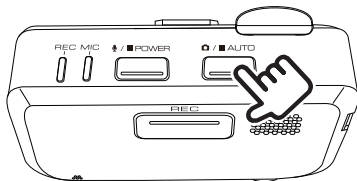

Note

- The recording data is saved to the "PICTURE(Still Images)" folder.
- Recording already in progress will not halt even if still images are recorded.
- Still images are saved with the same resolution as set by [Resolution + HDR Recording]. (P.29)
- The number of still images that are captured automatically and the interval of time can be changed.(P.29)
- A photo cannot be taken when the device is not recording such as during playback or when configuring menu settings.
- The automatic still image capture function turns off in any of the following states:
 - Device powered off
 - No SD card mounted
 - Setup screen on display
 - Recording file list on display

Parking recording

Turning off the accessories power (ACC) turns off the power of the device and switches to parking recording mode to perform vehicle collision monitoring. If the vehicle is subjected to a collision, the power of the device turns on and parking recording starts. When parking recording ends, vehicle collision monitoring resumes.

Collision detected



The duration of parking recording can be selected from among 10 seconds (default) , 20seconds and 30 seconds.(P.29)

Note

- The recording data is saved to the "PARKING (Parking Recordings)" folder.
- Parking recording starts a few seconds after the vehicle is subjected to a collision.
- If parking recording is performed, a notification alert tone (pong) sounds and a message ("A Parking Recording has occurred.") is displayed to inform you that parking recording has been performed since the power turned on.
- You can turn off the alert tone sounding and message display function.(P.30)
- Parking recording may be disabled for a certain period of time when getting on or off your car. For setting instructions, see page 29.
- Parking recording will not functional if you power off this device with its power button before turning off the car ignition key.
- The sensitivity of impact detection can be set. (P.30)

Folder and File Structure

Recorded data is organized into a folder for each item, and file names are assigned automatically in order using dates and file numbers.

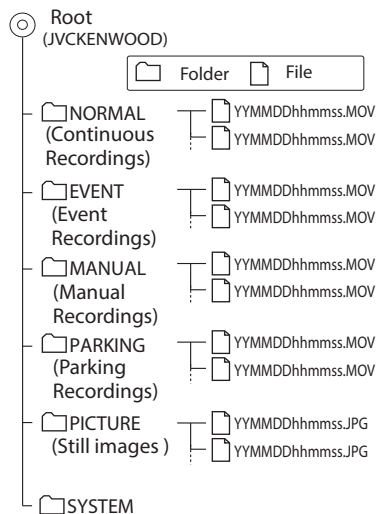

File name format

YYMMDDhhmmss.MOV

YY MM DD hh mm ss .JPG

— — — — —
Year Month Day Hour Minute Second

Note

- Do not change or delete the files in the SD card using a PC or other device. The files may become no longer playable with the device or the PC application.
- The time zone and other settings are not reflected in the file name; it appears as UTC.

Playing a Recording File

1. Press the MENU button
2. Touch [Camera].



3. Touch [Play].



4. Touch [Menu].



5. Select the recording file folder from which you want a recording file played.



6. Select the recording file you want played.

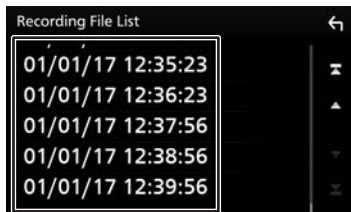







The recording file starts playing.

Note

- The operating buttons will clear after a certain period of time.
- Recording halts while a folder or file is being selected or is playing. Manual recording is also disabled.



- ① Folder
- ② "🔒" appears to designate a protected file.
- ③ Shooting start date and time
- ④ Playback state
- ⑤ Playback time
- ⑥ Appears when HDR is [ON].
- ⑦ Recording image quality

Button	Explanation
	Adjusts the audio volume.
	Starts playback/pauses.
	Touch while playing a file to toggle the playback speed between fast-forward and fast-rewinding. Touch while a file is paused to forward or reverse the file frame by frame. Continue touching while a file is paused to play the file at a slow speed.
	Plays the previous or next file.
[Delete]	Deletes the file that is playing.
	Protects or unprotects the file that is playing. A protected file is identified by a "🔒" appearing at the beginning of the file name.
	Zooming in a Playing Video
[Hide]	Hides the operating buttons on the screen.

Zooming in a Playing Video

The video that is playing appears zoomed in.

1. Play the file you want zoomed in.
2. Touch .



Select from among [x1], [x2] and [x4].

: Zooms out.

3. Touch the position you want displayed.



The display appears centering around the position touched.

Note

- The operating buttons will clear after a certain period of time.

Protecting or Deleting Files

Protecting Files

Note

- Continuous recording files cannot be protected.

1. Play the file you want protected.
2. Touch .



A confirmation message appears.

3. Touch [Yes].

The protected file is identified by a  appearing at the beginning of the file name.

Unprotecting a file

1. Play a protected file.
2. Touch .



A confirmation message appears.

3. Touch [Yes].

The file is unprotected.

Deleting Files/Folders

Deleting a file

1. Play the file you want deleted.
2. Touch [Delete].



A confirmation message appears.

3. Touch [Yes].

The file that is playing is deleted.

Deleting a folder as a whole

1. Press the MENU button
2. Touch [Camera].



3. Touch [Camera].



4. Touch [Menu].



5. Touch [Delete].

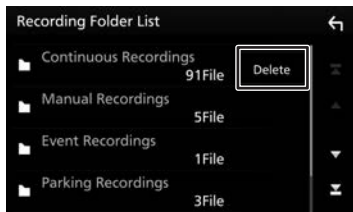

6. Select the folder you want deleted.



A confirmation message appears.

7. Touch [Yes].

All the files in the selected folder are deleted.

Note

- Before deleting a protected file, unprotect it first.

Various Settings

Note

- Recording halts while the setup menu is on display. Manual recording is also disabled.

1. Press the MENU button.
2. Touch[Camera].



3. Touch [REC].



Displays the operating buttons on the screen.

4. Touch [Settings].



5. Select setup items.



6. Set individual items.

Recording Settings	
[Resolution + HDR Recording]	[1280×720]/[1280×720+HDR]/[1920×1080]/[1920×1080+HDR*]/[3M](2304×1296) Sets the recording resolution. Set to (HDR) to record a subject with overexposure/underexposure suppressed even in a situation involving large differences in brightness. (The image quality cannot be set by recording mode.)
[Audio Recording]	ON*/OFF Set whether or not to record audio with the microphone during recording.
[Continuous Recording File Length]	1 min*/2 min/3 min Set the recording time for continuous recording. The recording is divided each time the recording time elapses.
[Manual Recording Time]	15 sec*/30 sec/1 min Set the recording time for manual recording. The recording time for before manual recording is set to 12 seconds.
[Event Recording Time]	15 sec*/30 sec/1 min Set the recording time for after collision detection. The recording time for before vehicle collision detection is set to 12 seconds.
[Overwrite (Manual)]	ON/OFF* Set whether or not to overwrite old files when the maximum number of recording files will be exceeded.
[Overwrite (Event)]	ON/OFF* Set whether or not to overwrite old files when the maximum number of recording files will be exceeded.
[Sensitivity Settings]	1(Low)/2/3(Mid)*/4/5(High) Set the sensitivity for detecting a vehicle collision. 1: Detects large collisions, 3: Standard, 5: Detects small collisions
[Interval of Automatic Still Images Capture]	1 min/5 min*/15 min/30 min Set the interval of capturing a still image with the automatic still image capture function.
[Maximum Number of Automatic Still Images]	10 files/30 files*/50 files Set the number of still images to be captured with the automatic still image capture function.
Parking Recording Settings	
[Parking Recordings]	ON*/OFF Turns the parking recording function on or off.
[Recording Time]	10 sec*/20 sec/30 sec Set the recording time for parking recording after collision detection.
[Overwrite]	ON*/OFF Set whether or not to overwrite old files when the maximum number of recording files will be exceeded.

[Sensitivity Settings]	1(Low)/2/3(Mid)*4/5(High) Set the sensitivity for detecting a vehicle collision while parked. 1: Detects large collisions, 3: Standard, 5: Detects small collisions
[Exit Time after ACC OFF]	OFF/30 sec*/1 min/3 min Turn off the ignition key and then set the period of time for which parking recording is disabled.
[Entry Time before ACC ON]	OFF/30 sec*/1 min/3 min Set the period of time for which parking recording is disabled before the ignition key is turned on.
[Parking Recording Notification]	ON*/OFF(P.22)
Driving Support Settings	
[Forward Collision Warning]	ON / ON(Beep Only) / OFF*(P.18)
[Lane Departure Warning]	ON / ON(Beep Only) / OFF*(P.18)
[Departure Delay Warning]	ON / ON(Beep Only) / OFF*(P.18)
[Detection Range Settings]	Before using the driving support function, adjust the horizon and bonnet front edge position settings to match the vehicle. (P.16)
[Mounting Height Settings]	1.2 m*/1.35 m/2 m Set the mounting height of the device from the road surface. (P.16)
System Settings	
[Time Zone]	Set the time zone. (P.12)
[Daylight Saving Time]	OFF*/+1 hr./+30 min Set daylight saving time.(P.12)
[Time Format]	12-Hour/24-Hour*(P.12)
[Date Format]	Month/Day/Year / Day/Month/Year* / Year/Month/Day Set the format in which the date is displayed.(P.12)
[Notification Volume]	Set the notification volume to any of four levels (mute to maximum).(P.12)
[Select Units]	km /h , MPH* Switch to kilometer or mile display.(P.12)
[System Version]	Display the version of the device firmware.
[Update System]	Updates the device.(P.31)
[Format SD Card]	Formats the SD card.(P.35)
[Factory Reset]	Reset the device settings to the factory default state.

Updating the system

Update the system firmware of the device.

For information regarding updates, visit the JVCKENWOOD website at <http://www.kenwood.com/cs/ce/>.

Using the PC Application

KENWOOD DRIVE REVIEWER is a PC application for displaying video recorded with the device.

The application can be downloaded from the JVC KENWOOD website at <http://www.kenwood.com/cs/ce/>

System Requirements for KENWOOD DRIVE REVIEWER

OS: Microsoft Windows 10, Windows 8.1, Windows 7*

(except for the Windows 10 Mobile, Windows RT)

* Windows 7 Service Pack 1 must be installed.

OS: Apple Mac OS X 10.11 (El Capitan) or later

- Microsoft, and Windows are registered trademark or trademark of Microsoft Corporation in the US and other countries.
- Macintosh, Mac are trademarks of Apple Inc., registered in the U.S. and other countries.

Installing the Software

- 1. Download the installer from <http://www.kenwood.com/cs/ce/>.**
- 2. Double-click <Setup.msi> of the application software downloaded to the PC and following the on-screen instructions to install KENWOOD DRIVE REVIEWER.**

- If a user account control alert window appears, click with [Yes].

Playing Files

- 1. Remove the SD card from the device, insert it in the SD card adapter (commercially available), and then connect it to the PC using a card reader .**
- 2. Start KENWOOD DRIVE REVIEWER.**
- 3. Select the drive for the SD card.**

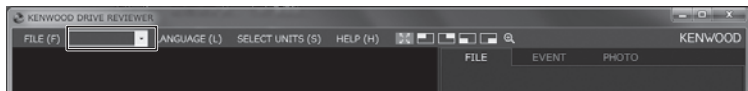

Screen operations

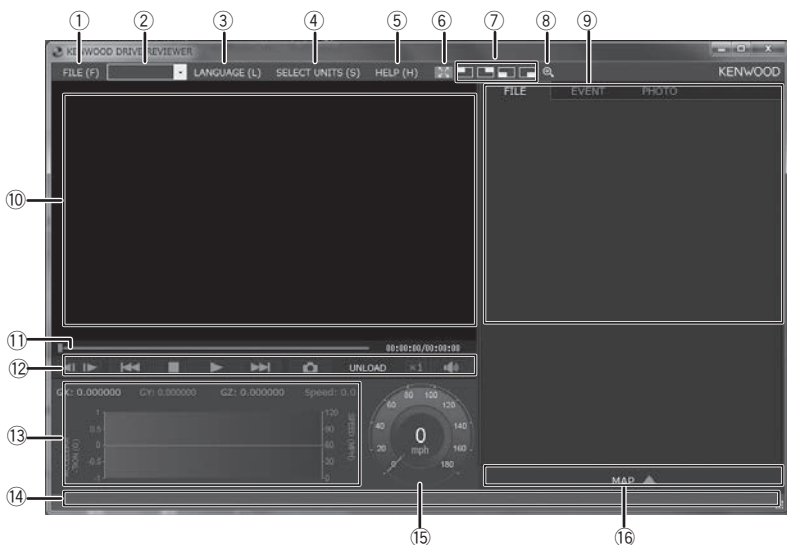

① FILE

SELECT FOLDER	Select the folder containing the file to be read.
EXPORT kmz/kml*	Output a driving information file (kml/kmz) that can be used with the GoogleMaps™ map service or GoogleEarth™ map service.
BACKUP	Back up the SD card data to the hard disk of a PC, etc.
EXIT	Exit the PC application.

*The kmz file or kml file contains data to be loaded into Google Earth.

② Drive list

Select a drive.

③ LANGUAGE

Select a display language.

④ SELECT UNITS

Selects kilometer or mile display.

⑤ HELP

Lets you verify the version of the application.

⑥

Returns an enlarged-view display to a regular-view display.

⑦

Magnifies the upper left, upper right, lower right and lower left corners of the screen (by two times).



⑧ Move the displayed frame to display an arbitrary location enlarged to a maximum of five times the size. Press [RESET] to display at actual size (1x).

⑨ File list



① Lists all movies.

② Lists manual recording, event recording and parking recording files.

③ Lists still image files and automatically recorded still image files.

⑩ Video screen

⑪ Track Bar/Playback Time/Remaining Playback Time



⑫ Operation buttons

	Displays the previous or next frame of the video.
	Displays the previous or next file.
	Stops playback.
	Pressing this during playback pauses playback. Pressing it again resumes playback.
	Captures an image at the point pressed.
	Changes the playback speed.
	Adjusts the volume.

⑬ G-sensor chart

Displays waveforms of acceleration for movement in the forward/backward (X), left/right (Y), and up/down (Z) directions of the vehicle.

⑭ Folder to store the selected file

⑮ Speed meter

Displays the speed of the vehicle.

⑯ MAP

Display a map for the location of a recorded video. An Internet connection is required to use MAP.

Outputting a Still Image from Video

Capture video at any location from the video currently playing as a still image.

1. Select and play the file you wish to play.
2. Press the  button.
3. Select the backup destination folder and enter a file name.

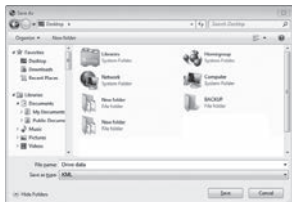

4. Press the [Save] button.

Outputting Driving Information

Output a driving information file (kml/kmz) that can be used with the GoogleMaps™ map service or GoogleEarth™ map service.

1. Select <EXPORT kml/kmz (E)> from FILE (F).
2. Select the backup destination folder, select the file type (kml/ kmz), and enter a file name.

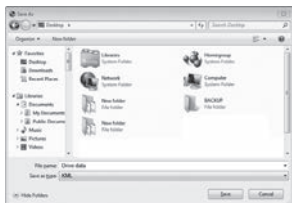

3. Press the [Save] button.

Note

- For how to use the file, see the help of the GoogleMaps™ map service or GoogleEarth™ map service.

Backing Up Files

Back up the SD card data to the hard disk of a PC, etc.

1. Select <BACKUP (B)> from FILE (F).



2. Select the backup destination folder.
3. Select the files to back up by selecting check boxes for the files you wish to save.



4. Press the [EXECUTE] button.

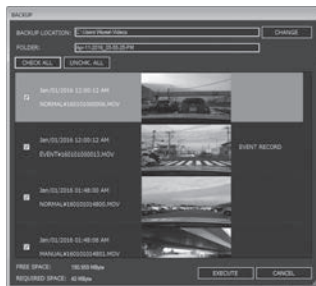

Formatting an SD Card

If an error appears when playing a video or saving a file, the SD card data may have been corrupted. Format the SD card.

Note

- Basically, SD cards essentially do not require formatting. Format an SD card only if errors occur when writing to or reading from the SD card.
- Do not format SD cards on other than this device.
- Formatting an SD card will erase all the data stored on that card, including protected files. If your SD card contains important data, save it to a PC or other media before formatting it.

1. Press the MENU button.

2. Touch [Camera].



3. Touch [Camera].



4. Touch [Settings].



5. Touch [System Settings].



6. Touch [Format SD Card].

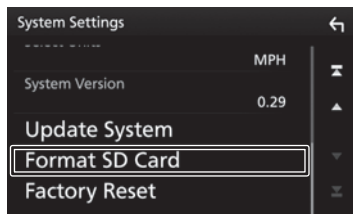

A confirmation message appears.

7. Touch [Yes].

Troubleshooting

Common

Symptom	Cause/Solution
Power does not turn on.	<ul style="list-style-type: none"> ✓ Turn on the accessories power (ACC) switch of the vehicle or start the engine of the vehicle. • The fuse has blown. ✓ Check the cords are not shorted and then replace the fuse with one of the same capacity. • The connections of the power cord are incorrect. ✓ Confirm the connections with the dealer.
Cannot record.	<ul style="list-style-type: none"> • An SD card is not inserted. • An SD card of a capacity other than 8 GB to 32 GB is inserted. • An SD card that does not comply with the SDHC standards is inserted. • The SD card is not formatted. ✓ Insert an SD card that can be used with the device into the SD card slot. ✓ If necessary, format the SD card with the device. • The internal temperature of the device is high. ✓ Reduce the temperature inside the vehicle. The protection circuit operation will be canceled and recording will become possible.
Can I play recorded videos on a general-purpose program, such as Windows Media Player?	Videos may or may not play depending on your player software. Further, information, such as speed and position, may or may not be verified. Please use KENWOOD DRIVE REVIEWER, a program compatible with this device (P.31).

Displayed Messages and Voice Guidance

If any of the following messages appears, resolve the problem as described in the table below. Voice guidance is also played for messages with the * mark.

message	Cause/Solution
No SD card inserted*	<ul style="list-style-type: none"> • The power was turned on while no SD card was inserted. • The SD card was removed during recording. ✓ Refer to "Cards supported by this device" and then insert an SD card that can be used with the device into the SD card slot. (P.5)
SD card error*	<ul style="list-style-type: none"> • An SD card that cannot be recognized is inserted. ✓ Refer to "Cards supported by this device" and then insert an SD card that can be used with the device into the SD card slot. (P.5)
SD card requires formatting*	<ul style="list-style-type: none"> • The SD card is not formatted in a format that can be recognized. ✓ If necessary, refer to "Formatting an SD Card" and then format the SD card with the device. (P.35)

message	Cause/Solution
Formatting failed	<ul style="list-style-type: none"> • The SD card has malfunctioned. ✓ Replace the SD card with a new one. SD cards have a product lifespan, such as the number of times that writing can be performed.
Uncompatible SD card	<ul style="list-style-type: none"> • An SD card with a capacity less than 8 GB or more than 32 GB is inserted. ✓ Refer to "Cards supported by this device" and then insert an SD card that can be used with the device into the SD card slot. (P.5)
Dashboard camera has stopped recording. Please check the SD card.*	<ul style="list-style-type: none"> • The SD card was removed during recording. • Recording became no longer possible due to a failure of the SD card. • Recording stopped due to some problem occurring. • Recording may stop if an SD card of an incompatible speed class is used. ✓ Reinsert the SD card. ✓ Replace the SD card with a new one. ✓ Change the overwrite setting of the [Recording Settings]. (P.29) ✓ Replace the SD card with a compatible one.
Dashboard camera has stopped recording due to no space in the SD card.	<ul style="list-style-type: none"> • The free space required to start continuous recording is not available on the SD card. • The free space required to record up to the file limit for manual recording or event recording is not available. ✓ Refer to "Protecting or Deleting Files" and then delete unnecessary files. (P.26) ✓ Back up any necessary data to a PC or other device, refer to "Formatting an SD Card," and then format the SD card with the device. (P.35)
Event recording failed (file limit exceeded)	<ul style="list-style-type: none"> • [Overwrite (Event)] is [OFF] and the file limit of the folder for event recordings has been reached. ✓ When [Overwrite (Event)] is set to [ON], old files are deleted to record.(P.29)
Manual recording failed (file limit exceeded)	<ul style="list-style-type: none"> • [Overwrite (Manual)] is [OFF] and the file limit of the folder for manual recordings has been reached. ✓ When [Overwrite (Manual)] is set to [ON], old files are deleted to record. (P.29)
Still image shooting failed (file limit exceeded)	<ul style="list-style-type: none"> • The file limit for still images has been reached. ✓ Refer to "Protecting or Deleting Files" and then delete unnecessary files.(P.26)
Cannot play this file.	<ul style="list-style-type: none"> • A file that cannot be played was recorded for some reason. • Data can no longer be read due to a failure of the SD card. ✓ Back up any necessary data to a PC or other device, refer to "Formatting an SD Card," and then format the SD card with the device. (P.35)

message	Cause/Solution
Dashboard camera has stopped recording due to high temperature.	<ul style="list-style-type: none"> • Recording was not possible due the temperature of the device rising. ✓ Reduce the temperature inside the vehicle. The protection circuit operation will be canceled and recording will become possible.
Dashboard camera will turn off due to high temperature.	<ul style="list-style-type: none"> • The power was turned off for safety reasons due to the temperature of the device rising. ✓ Reduce the temperature inside the vehicle. The protection circuit operation will be canceled and recording will become possible.
No update file available	<ul style="list-style-type: none"> • There is no firmware data in the SD card. ✓ Insert firmware data for the device in the SD card. • The update file in the SD card is the same as or older than the current firmware version. ✓ Insert the latest firmware data. ✓ If the SD card contains the latest firmware data, an update is not necessary because the firmware of the device is up to date.
System update failed	<ul style="list-style-type: none"> • The update file could not be read properly from the SD card. • The update file is damaged. ✓ Format the SD card in the device, copy the update data to the SD card again, and then perform the update operation again.
Disconnected	<ul style="list-style-type: none"> • The device is not connected properly. • The device is powered off. ✓ Verify the connection by consulting instructions in "How to Wire."(P.10) ✓ Turn on the power.

■ KENWOOD DRIVE REVIEWER

Symptom	Cause/Solution
Data appearing shorter than the preset period of recording	If an impact is detected immediately after the power is turned on or if the power is turned off immediately after an impact is detected, video would appear shorter than the preset period of time.
Viewer program has been deleted	Download the installer from the dedicated website and reinstall the program.
Viewer program won't launch.	Verify the operating environment of the viewer program. If no problems are found, reinstall the viewer program.
Video won't start playing	Reload the file. If the video still won't play, the file may have been corrupted.
Video plays but does not sound	[Audio Recording] may have been set to [OFF] in [Recording Settings]. Further, verify if either the viewer program or your PC does not have its volume set to a minimum.

Symptom	Cause/Solution
Video corrupted or audio disrupted while playing	Verify whether your PC meets requirements for the recommended operating environment (P.31). Video or audio might be disrupted if your PC is functionally deficient or any other application is running.
Wrong own vehicle position	GPS information may not be received properly, leaving the own vehicle position out of sync depending on where the vehicle runs, e.g., in a tunnel, under an elevated structure or along a street between building, on GPS satellite conditions.
Wrong speed	Because the speed is derived from the vehicle speed information on the navigation system, it may appear out of sync depending on the status of sensor learning by the navigation system or GPS satellite conditions.
Playing erratically	If any other application is running other than "KENWOOD DRIVE REVIEWER", shut it down.
The displayed position information and vehicle speed do not change.	During navigation simulation, recording is performed but the position information and vehicle speed do not change.

Specifications

Image sensor

1/3-inch color CMOS

Maximum recording angles of view

Horizontal: Approx. 117 degrees,

Vertical: Approx. 63 degrees

(Diagonal 128 degrees)

Lens

Wide-angle, F-number 2.0

Recording resolution (maximum)

Video maximum 2.98 million pixels

2304x1296 (1296P)

1920x1080 (1080P)

1280x720 (720P)

Frame rate

27 fps

Recording files

Video

Recording format: MOV

Video: H.264

Audio: Linear PCM

Still image

JPEG (maximum 2304x1296)

Recording media

microSDHC card

8 to 32 GB supported (Class 6 or higher)

G-sensor

Built-in

Collision sensitivity

-4.0 G to +4.0 G (in 0.1 G increments)

Power voltage

14.4 V (8.5 to 16 V)

Current consumption

400 mA

Operating temperature range

-10°C to +60°C

External dimensions (W) x (H) x (D)

W:79mm x H:22mm (with Mounting

kit:66mm) x D:48mm

W:3-1/8 x H:7/8 (with Mounting kit

2-5/8inch) x D:1-7/8 inch

Weight

Approx. 2.8 oz/ 77 g (excluding cord)

- The specifications and design are subject to change due to technological developments.

Important Notices Regarding Trademarks and Software

microSDHC logo is a trademark of SD-3C, LLC.

©2015 Google Inc. All rights reserved. GoogleMaps™ and GoogleEarth™ are registered trademarks of Google Inc.

This product is licensed only for the following applications based on the AVC Patent Portfolio License.

1) Consumers recording video (hereinafter referred to as AVC Video) compliant with the MPEG-4 AVC standard for personal use and non-profit purposes.

2) Playing AVC Video (video consumers recorded for personal use and non-profit purposes or video recorded by a provider that has obtained a license from MPEG LA) For details, refer to the MPEG LA, LLC. website.

<http://www.mpegla.com/>

MD5 utility

```
/* crypto/md5/md5.h */
```

Copyright (C) 1995-1998 Eric Young (eay@cryptsoft.com) All rights reserved.

This package is an SSL implementation written

by Eric Young (eay@cryptsoft.com).

The implementation was written so as to conform with Netscapes SSL.

This library is free for commercial and non-commercial use as long as the following conditions are adhered to. The following conditions apply to all code found in this distribution, be it the RC4, RSA, lhash, DES, etc., code; not just the SSL code.

The SSL documentation included with this distribution is covered by the same copyright terms except that the holder is Tim Hudson (tjh@cryptsoft.com).

Copyright remains Eric Young's, and as such any Copyright notices in the code are not to be removed.

If this package is used in a product, Eric Young should be given attribution as the author of the parts of the library used.

This can be in the form of a textual message at program startup or in documentation (online or textual) provided with the package.

Redistribution and use in source and binary forms, with or without modification, are permitted provided that the following conditions are met:

1. Redistributions of source code must retain the copyright notice, this list of conditions and the following disclaimer.
2. Redistributions in binary form must reproduce the above copyright notice, this list of conditions and the following disclaimer in the documentation and/or other materials provided with the distribution.
3. All advertising materials mentioning features or use of this software must display the following acknowledgement: "This product includes cryptographic software written by Eric Young (eay@cryptsoft.com)"
4. The word 'cryptographic' can be left out if the rouines from the library being used are not cryptographic related :-).
5. If you include any Windows specific code (or a derivative thereof) from the apps directory (application code) you must include an acknowledgement:
6. "This product includes software written by Tim Hudson (tjh@cryptsoft.com)"
THIS SOFTWARE IS PROVIDED BY ERIC YOUNG ``AS IS'' AND ANY EXPRESS OR IMPLIED WARRANTIES, INCLUDING, BUT NOT LIMITED TO, THE IMPLIED WARRANTIES OF MERCHANTABILITY AND FITNESS FOR A PARTICULAR PURPOSE ARE DISCLAIMED. IN NO EVENT SHALL THE AUTHOR OR CONTRIBUTORS BE LIABLE FOR ANY DIRECT, INDIRECT, INCIDENTAL, SPECIAL, EXEMPLARY, OR CONSEQUENTIAL DAMAGES (INCLUDING, BUT NOT LIMITED TO, PROCUREMENT OF SUBSTITUTE GOODS OR SERVICES; LOSS OF USE, DATA, OR PROFITS; OR BUSINESS INTERRUPTION) HOWEVER CAUSED AND ON ANY THEORY OF LIABILITY, WHETHER IN CONTRACT, STRICT LIABILITY, OR TORT (INCLUDING NEGLIGENCE OR OTHERWISE) ARISING IN ANY WAY OUT OF THE USE OF THIS SOFTWARE, EVEN IF ADVISED OF THE POSSIBILITY OF SUCH DAMAGE.

The license and distribution terms for any publically available version or derivative of this code cannot be changed. i.e. this code cannot simply be copied and put under another distribution license [including the GNU Public License.]

CRC utility

COPYRIGHT (C) 1986 Gary S. Brown. You may use this program, or code or tables extracted from it, as desired without restriction.

First, the polynomial itself and its table of feedback terms. The polynomial is $X^{32} + X^{26} + X^{25} + X^{23} + X^{22} + X^{16} + X^{12} + X^5 + 1$

Note that we take it "backwards" and put the highest-order term in the lowest-order bit. The X^{32} term is "implied"; the LSB is the X^{31} term, etc. The X^0 term (usually shown as "+1") results in the MSB being 1. Note that the usual hardware shift register implementation, which is what we're using (we're merely optimizing it by doing eight-bit chunks at a time) shifts bits into the lowest-order term. In our implementation, that means shifting towards the right. Why do we do it this way? Because the calculated CRC must be transmitted in order from highest-order term to lowest-order term. UARTs transmit characters in order from LSB to MSB. By storing the CRC this way we hand it to the UART in the order low-byte to high-byte; the UART sends each low-bit to high-bit; and the result is transmission bit by bit from highest- to lowest-order term without requiring any bit shuffling on our part. Reception works similarly.

The feedback terms table consists of 256, 32-bit entries. Notes

The table can be generated at runtime if desired; code to do so is shown later. It might not be obvious, but the feedback terms simply represent the results of eight shift/xor operations for all combinations of data and CRC register values

The values must be right-shifted by eight bits by the "updcrc logic; the shift must be unsigned (bring in zeroes). On some

hardware you could probably optimize the shift in assembler by using byte-swap instructions polynomial \$edb88320 CRC32 code derived from work by Gary S. Brown.

About Open Source Software included in the viewer software

This viewer software includes certain open source or other software originating from third parties that is subject to the GNU General Public License version 3 (GPLv3) and different copyright licensees, disclaimers and notices. The source code of software licensed under GPLv3 and different copyright licenses, disclaimers and notices are distributed at the website below, <http://www.kenwood.com/gpl>

Important notices regarding software

This product uses software components (licensed software) in accordance with the software license agreements granted by third parties. For details, view the support information for this product at <http://www.kenwood.com/cs/ce/>.

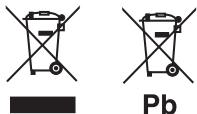

Information on Disposal of Old Electrical and Electronic Equipment and Batteries (applicable for countries that have adopted separate waste collection systems)

Products and batteries with the symbol (crossed out wheeled bin) cannot be disposed as household waste.

Old electrical and electronic equipment and batteries should be recycled at a facility capable of handling these items and their waste by products.

Contact your local authority for details in locating a recycle facility nearest to you. Proper recycling and waste disposal will help conserve resources whilst preventing detrimental effects on our health and the environment.

Notice: The sign "Pb" below the symbol for batteries indicates that this battery contains lead.

מידע בדבר השלכה לאשפה של ציוד חשמלי ואלקטרוני ישן וכן סוללות (רלוונטי למדינות שמשמשות במערכת איסוף אשפה מופרדת).

לא ניתן להשליך מוצרים וסוללות עם הסימון (פח אשפה עם X עליו) כאשפה ביתית רגילה. יש למחזר ציוד חשמלי ואלקטרוני ישן וכן סוללות במתקן המסוגל לטפל בפריטים כאלה ובתוצרי הלוואי שלהם. צרו קשר עם הרשות המקומית לקבלת פרטים אודות מתקן המיחזור הקרוב אליכם. מיחזור והשלכה לאשפה נאותים ינצרו לשמר משאבים ולמנוע השפעות שליליות על בריאותנו ועל הסביבה. שימו לב: הסימון Pb שמתחת לסימון עבור סוללות מצוין שהסוללה מכילה עופרת.

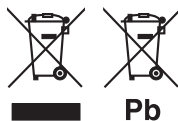



Declaration of Conformity with regard to the RE Directive 2014/53/EU

Declaration of Conformity with regard to the RoHS Directive 2011/65/EU

Manufacturer:

JVC KENWOOD Corporation
3-12, Moriya-cho, Kanagawa-ku, Yokohama-shi, Kanagawa,
221-0022, Japan

EU Representative:

JVCKENWOOD NEDERLAND B.V.
Amsterdamseweg 37, 1422 AC UITHOORN, The Netherlands

English

Hereby, JVCKENWOOD declares that the radio equipment "DRV-N520" is in compliance with Directive 2014/53/EU. The full text of the EU declaration of conformity is available at the following internet address:
<http://www.kenwood.com/cs/ce/eudoc/>

Français

Par la présente, JVCKENWOOD déclare que l'équipement radio « DRV-N520 » est conforme à la directive 2014/53/UE. L'intégralité de la déclaration de conformité UE est disponible à l'adresse Internet suivante:
<http://www.kenwood.com/cs/ce/eudoc/>

Deutsch

Hiermit erklärt JVCKENWOOD, dass das Funkgerät "DRV-N520" der Richtlinie 2014/53/EU entspricht. Der volle Text der EU-Konformitätserklärung steht unter der folgenden Internetadresse zur Verfügung:
<http://www.kenwood.com/cs/ce/eudoc/>

Nederlands

Hierbij verklaart JVCKENWOOD dat de radioapparatuur "DRV-N520" in overeenstemming is met Richtlijn 2014/53/EU. De volledige tekst van de EU-verklaring van overeenstemming is te vinden op het volgende internetadres:
<http://www.kenwood.com/cs/ce/eudoc/>

Italiano

Con la presente, JVCKENWOOD dichiara che l'apparecchio radio "DRV-N520" è conforme alla Direttiva 2014/53/UE. Il testo integrale della dichiarazione di conformità UE è disponibile al seguente indirizzo internet:
<http://www.kenwood.com/cs/ce/eudoc/>

Español

Por la presente, JVCKENWOOD declara que el equipo de radio "DRV-N520" cumple la Directiva 2014/53/EU. El texto completo de la declaración de conformidad con la UE está disponible en la siguiente dirección de internet:
<http://www.kenwood.com/cs/ce/eudoc/>

Português

Deste modo, a JVCKENWOOD declara que o equipamento de rádio "DRV-N520" está em conformidade com a Diretiva 2014/53/UE. O texto integral da declaração de conformidade da UE está disponível no seguinte endereço de internet:
<http://www.kenwood.com/cs/ce/eudoc/>

Polska

Niniejszym, JVCKENWOOD deklaruje, że sprzęt radiowy "DRV-N520" jest zgodny z dyrektywą 2014/53/UE. Pełny tekst deklaracji zgodności EU jest dostępny pod adresem:
<http://www.kenwood.com/cs/ce/eudoc/>

Český

Společnost JVCKENWOOD tímto prohlašuje, že rádiové zařízení "DRV-N520" splňuje podmínky směrnice 2014/53/UE. Plný text EU prohlášení o shodě je dostupný na následující internetové adrese:
<http://www.kenwood.com/cs/ce/eudoc/>

Magyar

JVCKENWOOD ezennel kijelenti, hogy a „DRV-N520” rádióberendezés megfelel a 2014/53/EU irányelvnek. Az EU konformitási nyilatkozat teljes szövege az alábbi weboldalon érhető el:
<http://www.kenwood.com/cs/ce/eudoc/>

Svenska

Härmed försäkras JVCKENWOOD att radioutrustningen "DRV-N520" är i enlighet med direktiv 2014/53/EU. Den fullständiga texten av EU-försäkran om överensstämmelse finns på följande Internetadress:
<http://www.kenwood.com/cs/ce/eudoc/>

Suomi

JVCKENWOOD julistaa täten, että radiolaitte "DRV-N520" on direktiivin 2014/53/EU mukainen. EU-vaatimusten mukaisuusvakuutusvaatimus löytyy kokonaisuudessaan seuraavasta internetosoitteesta:
<http://www.kenwood.com/cs/ce/eudoc/>

Slovensko

S tem JVCKENWOOD izjavlja, da je radijska oprema »DRV-N520« v skladu z Direktivo 2014/53/EU. Celotno besedilo direktive EU o skladnosti je dostopno na tem spletnem naslovu:
<http://www.kenwood.com/cs/ce/eudoc/>

Slovensky

Spoločnosť JVCKENWOOD týmto vyhlasuje, že rádiové zariadenie „DRV-N520“ vyhovuje smernici 2014/53/EÚ. Celý text EÚ vyhlásenia o zhode nájdete na nasledovnej internetovej adrese:
<http://www.kenwood.com/cs/ce/eudoc/>

Dansk

Herved erklærer JVCKENWOOD, at radioudstyret "DRV-N520" er i overensstemmelse med Direktiv 2014/53/EU. EU-overensstemmelseserklæringens fulde ordlyd er tilgængelig på følgende internetadresse:
<http://www.kenwood.com/cs/ce/eudoc/>

Ελληνικά

Με το παρόν, η JVCKENWOOD δηλώνει ότι ο ραδιοεξοπλισμός «DRV-N520» συμμορφώνεται με την Οδηγία 2014/53/ΕΕ. Το πλήρες κείμενο της δήλωσης συμμόρφωσης της ΕΕ είναι διαθέσιμο στην ακόλουθη διεύθυνση στο διαδίκτυο:
<http://www.kenwood.com/cs/ce/eudoc/>

Eesti

Käesolevaga JVCKENWOOD kinnitab, et „DRV-N520“ raadiovarustus on vastavuses direktiiviga 2014/53/EL. ElI vastavusdeklaratsiooni terviktekst on kättesaadav järgmisel internetiaadressil:
<http://www.kenwood.com/cs/ce/eudoc/>

Latviešu

JVCKENWOOD ar šo deklarē, ka radio aparatūra „DRV-N520“ atbilst direktīvas 2014/53/ES prasībām. Pilns ES atbilstības deklarācijas teksts ir pieejams šādā tīmekļa adresē:
<http://www.kenwood.com/cs/ce/eudoc/>

Lietuviškai

Šiuo JVCKENWOOD pažymi, kad radijo įranga „DRV-N520“ atitinka 2014/53/EB direktyvos reikalavimus. Visą EB direktyvos atitikties deklaracijos tekstą galite rasti šiuo internetiniu adresu:
<http://www.kenwood.com/cs/ce/eudoc/>

Malti

B'dan, JVCKENWOOD jiddikjara li t-taghmir tar-radju "DRV-N520" huwa konformi mad-Direttiva 2014/53/UE. It-test kollu tad-dikjarazzjoni ta' konformità huwa disponibbli fl-indirizz intranet li ġej:
<http://www.kenwood.com/cs/ce/eudoc/>

HRVATSKI / SRPSKI JEZIK

JVCKENWOOD ovim izjavljuje da je radio oprema "DRV-N520" u skladu s Direktivom 2014/53/EU. Cjeloviti tekst deklaracije Europske unije o usklađenosti dostupan je na sljedećoj internet adresi:
<http://www.kenwood.com/cs/ce/eudoc/>

ROMÂNĂ

Prin prezenta, JVCKENWOOD declară că echipamentul radio "DRV-N520" este în conformitate cu Directiva 2014/53/UE. Textul integral al declarației de conformitate UE este disponibil la următoarea adresă de internet:
<http://www.kenwood.com/cs/ce/eudoc/>

БЪЛГАРСКИ

С настоящото JVCKENWOOD декларира, че радиооборудването на "DRV-N520" е в съответствие с Директива 2014/53/ЕС. Пълният текст на ЕС декларацията за съответствие е достъпен на следния интернет адрес:
<http://www.kenwood.com/cs/ce/eudoc/>

Turkish

Burada, JVCKENWOOD "DRV-N520" radyo ekipmanının 2014/53/AB Direktifine uygun olduğunu bildirir. AB uyumluluk deklarasyonunun tam metni aşağıdaki internet adresinde mevcuttur.
<http://www.kenwood.com/cs/ce/eudoc/>

Русский

JVCKENWOOD настоящим заявляет, что радиооборудование «DRV-N520» соответствует Директиве 2014/53/ЕU. Полный текст декларации соответствия ЕС доступен по следующему адресу в сети Интернет:
<http://www.kenwood.com/cs/ce/eudoc/>

Українська

Таким чином, компанія JVCKENWOOD заявляє, що радіобладнання «DRV-N520» відповідає Директиві 2014/53/ЕU. Повний текст декларації про відповідність ЄС можна знайти в Інтернеті за такою адресою:
<http://www.kenwood.com/cs/ce/eudoc/>

KENWOOD