



IMP PUMPS[®]

Intelligent Motor Pumps

www.imp-pumps.com



TECHNICAL CATALOGUE
TECHNISCHER KATALOG
English / Deutsch

GHN / GHND / GHNbasic (auto) F / GHNDbasic (auto) F / GHNM F / GHNMbasic F / GHNMDbasic F

Three speeds circulating pumps / Drehzahlkonstante Heizungsumwälzpumpen

7

- **GHN** / Threaded circulation pumps with three speeds / Dreistufige Verschraubungsumwälzpumpen mit manueller Drehzahlumschaltung **10**
- **GHND** / Threaded twin circulation pumps with three speeds/Dreistufige Verschraubungsumwälzpumpen mit manueller Drehzahlumschaltung in Zwillingausführung **13**
- **GHNbasic (auto) F** / Three speeds circulation pumps with flanges / Dreistufige Flanschumwälzpumpen mit manueller Drehzahlumschaltung **15**
- **GHNDbasic (auto) F** / Three speeds double circulation pumps with flanges / Dreistufige Flanschumwälzpumpen mit manueller Drehzahlumschaltung in Zwillingausführung **21**
- **GHNM F** / Three speeds circulation pumps with flanges / Dreistufige, einphasige Flanschumwälzpumpen mit manueller Drehzahlumschaltung **26**
- **GHNMbasic F** / Three speeds circulation pumps with flanges / Dreistufige, einphasige Flanschumwälzpumpen mit manueller Drehzahlumschaltung **27**
- **GHNMDbasic F** / Three speeds double circulation pumps with flanges / Dreistufige, einphasige Flanschumwälzpumpen mit manueller Drehzahlumschaltung in Zwillingausführung **30**

SAN / SANbasic F

Circulating pumps for sanitary water / Brauchwasser Zirkulationspumpen

41

- **SAN** / Threaded pumps for circulation of sanitary water with three speeds / Dreistufige Verschraubungsumwälzpumpen mit manueller Drehzahlumschaltung für Brauchwasseranwendungen **43**
- **SANbasic F** / Three speed circulation pumps for sanitary water with flanges / Dreistufige Flanschumwälzpumpen mit manueller Drehzahlumschaltung für Brauchwasseranwendungen **46**

GHN SOL

Pumps for solar systems / Pumpen für Solaranlagen

51

- **GHN SOL** Pumps for solar systems / Umwälzpumpen für Solaranwendungen **53**

ECL

Electronically controlled in-line pumps / Elektronisch geregelte Trockenläuferpumpen

57

- **ECL** / In-line pumps with separate frequency converter / Elektronisch geregelte Inlinepumpen mit integrierter Differenzdruckregelung und Frequenzumrichter **61**

CV / CL / CLD

In-line pumps / Trockenläuferpumpen

71

- **CV** / Standard in-line pumps / Standard - Inline Pumpen **73**
- **CL** / Standard in-line pumps / Standard - Inline Pumpen **75**
- **CLD** / Standard double in-line pumps / Standard - Inline Pumpen - Zwillingausführung **84**

CB

Block pumps / Trockenläuferpumpen

103

- **CB** / Block pumps / Blockpumpen **105**

PV /

Circulating pumps for sanitary water / Brauchwasser Zirkulationspumpen

115

- **PV** / In-line pumps for circulation of sanitary water / Trockenläufer - Inline - Brauchwasserpumpen **117**

MANUFACTURING RANGE OF IMP PUMPS

The major part of the manufacturing range of IMP PUMPS comprises pumps for the forced circulation of hot or cold water in heating, cooling, air conditioning and airing systems. With products from our strategic partners we can also offer customers pumps from other European manufacturers such as submerged and multi-phase pumps and drinking water systems, pumping systems for sewage and other specialist pumps for conveying liquid media.

Pumps from our range are divided with respect to the method of motor drive on the pump into wet-running rotor pumps and dry-running rotor pumps.

Wet-running rotor pumps

In wet-running rotor pumps the rotor of a special electric motor is submerged in the media. A divided insert built into the electric motor protects the stator coil from the media. The insert is made from non-magnetic alloyed steel. The shaft is of stainless material and rotates on graphite bearings. The bush is static. The media pumped under pressure through the system both cools the pump and reduces friction in the bearings.

Wet-running rotor pumps are noiseless and require little maintenance. They can be regulated with an e-commutator motor (NMT) or frequency converter (EGHN). Within the group of wet-running rotor pumps are also three-speed pumps.

Dry-running rotor pumps

In dry-running rotor pumps the rotor is a part of a standard electric motor fixed to the hydraulic pump casing with an O-ring. The electric motor and pump can be connected by a single shaft or split shaft with a clutch. The shaft is made from stainless material and rotates on axial-radial bearings. The bush is dynamic with floating seals. The media pumped under pressure through the system acts as a lubricant for rubbing surfaces on the floating seal that can be of various designs adapted to the kind of media.

HERSTELLUNGSPROGRAMM IMP PUMPS

Der Hauptteil des Herstellungsprogramms von IMP PUMPS umfasst Pumpen für den Zwangsumlauf von Warm- und Kaltwasser in in Heiz- und Kühlsystemen sowie Klima- und Brauchwasseranwendungen. Mit unserem Artikelergänzungsprogramm und mit Dienstleistungen strategischer Partner bieten wir auch Pumpen anderer europäischer Hersteller an: Tauchpumpen, Teichpumpen, mehrstufige Pumpen, Brauchwasserpumpen, Pumpsysteme für Fäkalien und andere Spezialpumpen für den transport flüssiger Medien.

Die Pumpen aus unserem Herstellungsprogramm teilen wir hinsichtlich ihrer Motorenantriebsart in Pumpen mit einem nasslaufendem Rotor und Pumpen mit einem trockenlaufendem Rotor ein.

Pumpen mit nasslaufendem Rotor

Bei Pumpen mit nasslaufendem Rotor ist der Rotor des Elektromotor besonderen Elektromotors im Medium versunken. Die Kammerbuchse, die im Gehäuse des Elektromotors eingebaut ist, schützt die Ständerwicklung vor dem Nasswerden. Die Buchse ist aus nichtmagnetischem, hochlegiertem Stahl hergestellt. Die Welle besteht aus rostfreiem Material und ist auf Grafitlagern gelagert. Die Abdichtung ist statisch. Das Medium, das die Pumpe durch das System drückt, kühlt die Pumpe und verringert die Reibung des Lagers.

Pumpen mit nasslaufendem Rotor sind geräuschlos und in der Instandhaltung anspruchslos. Hinsichtlich der Regulationsart können sie mit einem e-kommutierten Motor (NMT) oder mit einem Frequenzumrichter (EGHN) reguliert werden. Zu der Gruppe der Pumpen mit nasslaufendem Rotor gehören auch Pumpen mit dreistufiger Drehzahlregelung.

Pumpen mit trockenlaufendem Rotor

Bei Pumpen mit trockenlaufendem Rotor ist der Rotor Teil des Standardelektromotors, der mit einem Flansch am hydraulischen Gehäuse der Pumpe befestigt ist. Der Elektromotor und die Pumpe können durch eine Einheitswelle oder durch eine getrennte Welle mit der Kupplung verbunden sein. Die Welle ist aus nicht rostendem Material hergestellt und auf einem Axial-Radiallager gelagert. Die Abdichtung ist dynamisch mit Gleitdichtungen. Das Medium, das die Pumpe durch das System drückt, wirkt in der Pumpe wie ein Schmiermittel für die Gleitoberfläche der Gleitdichtung. Die Pumpe gibt es in verschiedenen Ausführungen.

SELECTION OF APPROPRIATE PUMP

Selection of three-speed pumps

The characteristics of the pumps are expressed in the curves illustrating the head H , power P and efficiency dependant on the flow Q . Data on the necessary flow and pressure drops in the system can be read from project documentation and compared with the technical characteristics of pump on graphs and the appropriate pump chosen.

The calculated point R with coordinates Q_r and H_r is the basis for choosing a pump. Pumps having three-stage revolutions have three Q - H curves and operate as shown in figure 1. The pump will operate in the actual working point D . This point is the intersection of the system hydraulic resistance curve and Q - H curve of the pump.

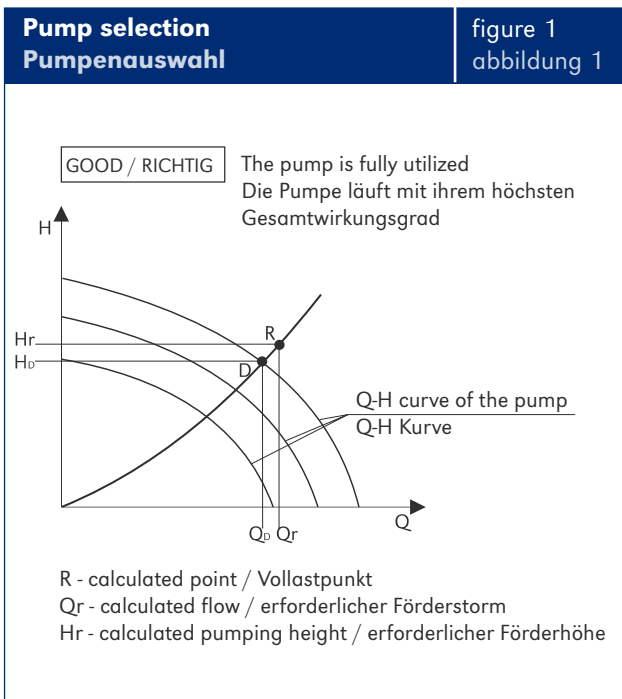

Selection of pump regulation

The operation of electronically regulated pumps is adapted to the requirements of the heating energy consumption in one year. Such an annual consumption can be seen on the graph, figure 2, showing the seasonal profile.

AUSWAHL DER ENTSPRECHENDEN PUMPE

Auswahl der Pumpen mit dreistufiger Drehzahlumschaltung

Die charakteristischen Eigenschaften der Pumpen sind durch Kurven ausgedrückt und veranschaulichen den Verlauf der Druckhöhe H , der Leistung P und der Ausnutzung in der Abhängigkeit vom Durchfluss Q . Die Angabe über den erforderlichen Durchfluss und über den Druckabfall im System ist aus der Projektdokumentation ersichtlich, wir vergleichen sie mit den technischen Charakteristiken der Pumpen auf den Grafen und wählen die entsprechende Pumpe aus.

Der errechnete Punkt R mit den Koordinaten Q_r und H_r ist Grundlage zur Auswahl der Pumpe. Die Pumpe, die drei Umdrehungsstufen hat, hat drei Q - R Kurven und funktioniert wie auf Abb. 1 aufgezeigt. Die Pumpe wird im tatsächlichen Arbeitspunkt D funktionieren. Dieser Punkt ist der Kurvenschnittpunkt des hydraulischen Systemwiderstands und der Q - H Kurve der Pumpe.

Auswahl der elektronisch geregelten Hocheffizienzpumpen

Elektronisch geregelte Hocheffizienzpumpen passen ihre Leistung und Energieverbrauch dem Heizsystem elektronisch an. Den Verlauf eines solchen durchschnittlich erforderlichen Verbrauchs sehen wir auf dem Grafen der Abb. 2, der ein saisonbelastetes Profil darstellt.

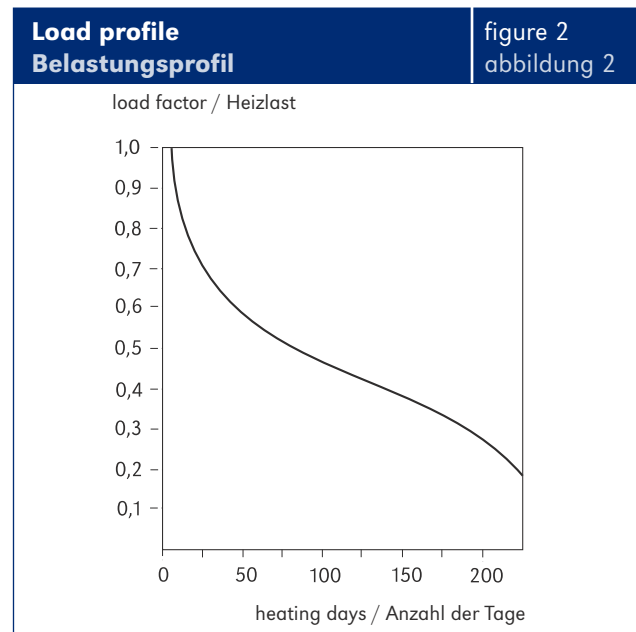

The correct choice of pump regulation (comparing the project requirements of pump characteristics with actual technical characteristics of certain pumps) is shown in figures 3, 4 and 5.

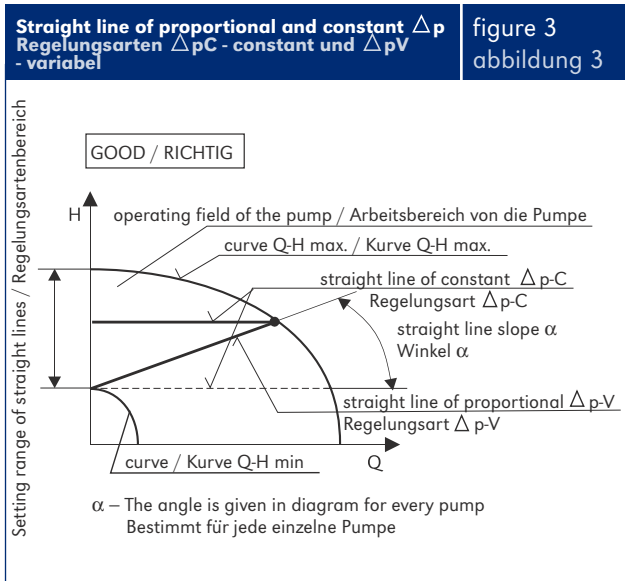

Das richtige Auswählen der regulierten Pumpen (Vergleichen der projektbedingten Charakteristiken der Pumpe mit den tatsächlichen technischen Charakteristiken einer Pumpe) ist auf Abb. 3, 4 und 5 dargestellt.

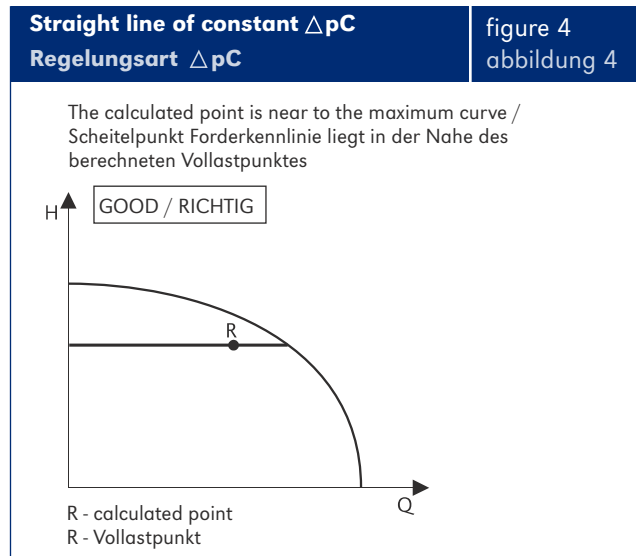

In regulating pumps we have available a complete field of operation of pumps between the maximum and minimum operating curve Q-H. We therefore call these regulations non-stage regulations. The calculated point R should be as close as possible to the maximum operating curve Q-H. From the figure of loading profiles we can read that the heating system operates with full thermal power for only few days in the year with the other days regulation reducing the electricity consumption. In the case of an optimal control system (also using thermostatic valves on the heater) a large part of the electrical energy is saved by regulating pumps. The installation of regulated pumps rather than non-regulated pumps, therefore, provides a great saving. These savings are shown in figure 6.

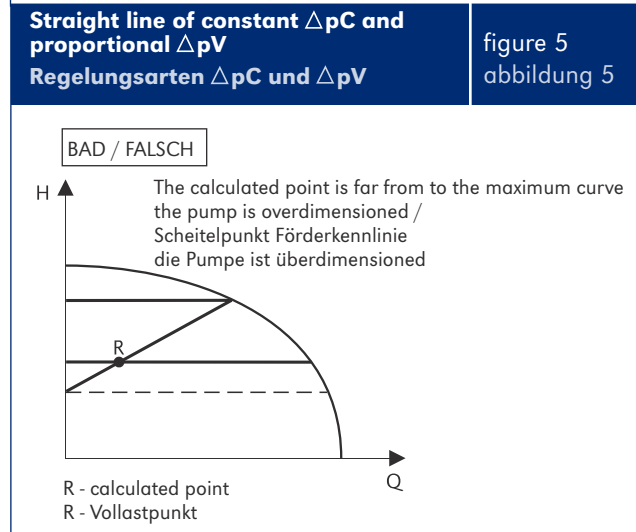

Bei den regulierten Pumpen haben wir das gesamte Funktionsfeld der Pumpe zwischen der maximalen und minimalen Funktionskurve Q-H zur Verfügung. Deshalb nennen wir diese Regulierung stufenlose Stetigkeitsregulierung. Der Rechnungspunkt R sollte möglichst nahe der maximalen Funktionskurve Q-H liegen.

Tage im Jahr arbeitet, an den übrigen Tagen verringert die Regulierung den Stromverbrauch. Im Falle der optimalen Steuerung des Systems (auch mit Hilfe von Thermostatventilen an den Heizungen) sparen wir mit regulierten Pumpen einen großen Teil der eingebrachten elektrischen Energie. Deshalb ermöglicht der Einbau von regulierten Pumpen anstelle von nicht regulierten eine große Energieeinsparung.

Aus der Abbildung des Belastungsprofils ist ersichtbar, dass das Heizsystem mit voller Wärmeleistung nur einige

Diese Einsparungen sind auf der Abbildung 6 dargestellt.

**Energy savings when using circulating pumps
Anlagenkennlinien bei Teillast**

figure 6
abbildung 6

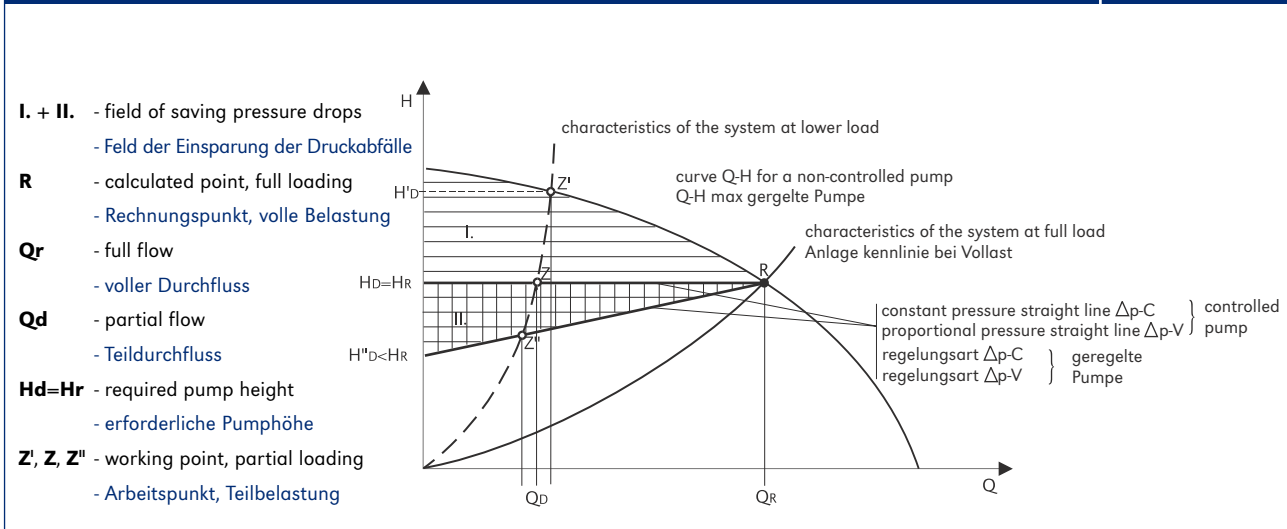

**TECHNICAL CHARACTERISTICS OF
REGULATED PUMPS**

**TECHNISCHE CHARAKTERISTIKA DER
REGULIERTEN PUMPEN**

Media viscosity

Viskosität der Medien

All hydraulic and other data in the technical catalogue apply to the media of water with cinematic viscosity of 1 mm²/s at 18 deg. C.

Alle hydraulischen und anderen Angaben im technischen Katalog gelten für das Medium Wasser mit einer kinematischen Viskosität = 1mm²/s bei einer Temperatur von 18°C.

If not stated for individual pumps, the normal pump operation must be found for the media, which is clean, normally flowing warm water (according to VDI 2035 standard that specifies the hardness and Ph of water), without aggressive or explosive additives, without mixtures of mineral oils or solid or fibrous particles. The cinematic viscosity of the water can be to 10cSt (mm²/s).

Wenn es bei den einzelnen Pumpen nicht besonders angeführt ist, muss für eine normale Funktionsfähigkeit der Pumpen ein Medium garantiert sein, das sauber ist, normales flüssiges Heizwasser (nach VDI 2035 Standard, der die Härte und den PH-Wert des Wassers bestimmt), ohne aggressive oder explosive Zusätze, ohne Beimischungen von Mineralöl und harten oder faserigen Teilen. Die kinematische Viskosität des Wassers kann bis zu 10 cSt (mm²/s) betragen.

If the viscosity of the water is between 1 and 10 cSt (mm²/s), the addition of antifreeze (e.g. glykol) for protecting the heating system does not adversely affect the pump. In planning systems for cooling it is necessary when choosing the pump to take into account changes in hydraulic parameters and power due to increased viscosity and density of the media.

Wenn die Viskosität des Wassers im Bereich von 1 bis 10 cSt (mm²/s) liegt, hat die Zugabe von Antifrostschutzmitteln (z.B. Glykol) keinen größeren Einfluss auf die Pumpe. Bei der Planung von Kühlsystemen sind bei der Auswahl der Pumpen wegen der größeren Viskosität und Dichte des Mediums die Veränderungen der hydraulischen Parameter und der Leistung zu beachten.

Required system pressure

In order that the pump operates without noise and cavi- tations, in addition to other conditions (choosing appro- priate pumps, positions, assembly) the appropriate pres- sure in the system must be found. IMP PUMPS will provide detailed information on this.

Minimum media flow















The media the pump forces around the system also acts as a coolant for the pump. The minimum flow the pump provides is 5% of the maximum flow for the same pump. We do not recommend running with closed valves.

Erforderlicher Systemdruck

Damit die Pumpe ohne Geräusche und Kavitation funk- tioniert, müssen wir neben den übrigen Bedingungen (Auswahl der entsprechenden Pumpe. Lage, Montage) einen entsprechenden Druck im System gewährleisten. Ausführlichere Informationen erhalten Sie im Unternehmen IMP Pumps.

Minimaler Durchfluss des Mediums

Das Medium, das die Pumpe durchs System drückt, dient auch der Kühlung der Pumpe. Der minimale Durchfluss, den die Pumpe gewährleisten muss, beträgt 5% des maximalen Durchflusses der gleichen Pumpe. Wir raten vom Betrieb bei geschlossenen Ventilen ab.

LEGEND OF SYMBOLS / BILDZEICHEN	
Electrical voltage / Elektroanschluss	 230 V  400 V
Connection type / Rohranschluss	 screw type gewind  flanges flansche
Lenght / Einbaulänge	 110 mm  130 mm  180 mm
Casing type / Werkstoffe	 bronze for sanitary water bronze - dementsprechend für Brauchwasser
Duble pump / Bautormausführung	 single pump einzel  double pump zwillingspumpe
Speed range / Drehzahlbereich	 1500 min ⁻¹  3000 min ⁻¹
Electrical scheme / Elektrische Daten	
Dimensions data / Maße	

IMP PUMPS holds the quality certificates ISO 9001:2000. Most of our pumps carry the CE mark of conformity to EU standards and IEC standards.



We retain the right to alter technical characteristics of IMP PUMPS products without prior notice and the right to errors in the technical catalogue.

IMP Pumps ist Inhaber des Qualitätsstandards ISO 9001:2000. Die Pumpen besitzen das Zertifikat "CE" für die Übereinstimmung der Erzeugnisse mit den EU-Standards und IEC Standards.



Wir behalten uns das Recht auf Veränderungen der technischen Eigenschaften der IMP Pumps Erzeugnisse ohne vorherige Benachrichtigung vor, wie auch das Recht auf Fehler im technischen Katalog.

GHN / GHND
GHNbasic (auto) F / GHNDbasic (auto) F
GHNM F / GHNMbasic F / GHNMDbasic F

GHN / GHND
GHNbasic (auto) F / GHNDbasic (auto) F
GHNM F / GHNMbasic F / GHNMDbasic F



Three speeds circulating pumps
Dreistufige Heizungsumwälzpumpe

Threaded circulation pumps with three speeds Dreistufige Verschraubungsumwälzpumpen mit manueller Drehzahlumschaltung

ADVANTAGES OF SMALL PUMPS FROM IMP PUMPS

Reliable operation and long lifespan

Endurance and durability trials show the new generation of circulation pumps for home central heating systems are reliable under various operating conditions. The top quality materials used in making parts provide the pumps with a long lifespan.

Silent operation

The silent operation of the pumps is the result of careful development and advanced technical solutions in designing parts.

Adaptability of pumps to the heating system

A three-way switch provides a choice of pump power and optimal adaption to heating system requirements.

All installation material is provided

To save you time and unnecessary searching for installation material, we supply quality seals.

Exchangeability with worn out products of other manufacturers

Pumps from IMP PUMPS are developed with international technical standards. They can replace worn out pumps from other manufacturers without additional expense or modified installation.

Expert help in selecting pumps for your heating system

Technically proficient sales staff in IMP PUMPS will advise you and help solve demanding problems in selecting the most suitable model of pump.

DIE VORTEILE KLEINER IMP PUMPS PUMPEN

Zuverlässiger Betrieb und lange Lebensdauer

Die neue Generation der kleinen Umwälzpumpen für das Hausheizsystem hat bei Tests der Strapazierfähigkeit und Dauerhaftigkeit bewiesen, dass sie zuverlässig funktionieren unter verschiedenen Arbeitsbedingungen. Hochwertige Materialien garantieren eine lange Lebensdauer.

Geräuscharmer Betrieb

Der geräuscharme Betrieb der Pumpen ist das Resultat sorgfältiger Entwicklung und fortschrittlicher technischer Lösungen bei der Gestaltung der Bestandteile der Pumpen.

Die Anpassungsfähigkeit der Pumpen an das Heizsystem

Der Dreistufenschalter ermöglicht die Wahl der Pumpenleistung und eine optimale Anpassung an die Erfordernisse des Heizsystems.

Das gesamte Montagematerial ist beigelegt

Damit Sie Zeit sparen und unnötiges Suchen von Montagematerial vermeiden können, haben wir allen Pumpen der Familie der kleinen Hauspumpen qualitätsvolle Dichtungen.

Austauschbarkeit mit ausgedienten Erzeugnissen anderer Hersteller

Die IMP PUMPS Pumpen sind in Übereinstimmung mit den internationalen technischen Standards entwickelt worden. Tauschen Sie ausgediente Pumpen anderer Hersteller durch entsprechende IMP PUMPS Pumpen ohne zusätzliche Kosten und ohne Veränderung der Installation aus.

Fachliche Hilfe bei der Auswahl geeigneter Pumpen für das Heizsystem

Es beraten Sie technisch bewanderte Verkäufer des Unternehmens IMP PUMPS und sie lösen auch ein noch so anspruchsvolles Problem bei der Auswahl des geeignetsten Pumpensystems.

Three speeds circulating pumps Dreistufige Heizungsumwälzpumpe

TEHNIICAL FEATURES / TECHNISCE MERKMALE		GHN	GHND	GHNbasic F GHNauto F	GHNDbasic F GHNDauto F	GHNMbasic F	GHNMDbasic F
Connections / Nennweite	DN (")	15, 20, 25, 32	32	40 - 100	40 - 80	40, 50	40, 50
Connection type / Rohranschluss		Screw Type/Gewind	Screw Type/Gewind	Flanges / Flansche	Flanges / Flansche	Flanges / Flansche	Flanges / Flansche
Flow max / Förderstrom max	Q (m³/h)	3/4/6/8/9/13	10,8/14,4/14,3	75	120	29,5	29,5
Head max / Förderhöhe	H (m)	4/6/6,5/7/8/8,5/12	6,4/7,3/10,8	19,5	19,5	14	14
Pressure rated / Betriebsdruck	PN (bar)	10	10	6 / 10	6 / 10	6 / 10	6 / 10
Power max / Leistungsaufnahme max	P (W)	50/90/95/140/210/265/277	140/210/265	2350	2350	930	930
Electrical voltage / Elektroanschluss	V	1 ~ 230 V	1 ~ 230 V	3 ~ 400 V	3 ~ 400 V	1 ~ 230 V	1 ~ 230 V
Degree of protection / Schutzart	IP	44	44	44	43	43/44	43
Regulation / Regelung		no / nein	no / nein	no / nein	no / nein	no / nein	no / nein
Media temperature / Temperaturbereich T(°C)		-10 to/bis +110	-10 to/bis +110	-10 to/bis +120	-10 to/bis +120	-10 to/bis +120	-10 to/bis +120
Insulating class / Isolationsklasse		H	H	200	200	200	200
Casing type / Werkstoffe		GG / Cast iron	GG / Cast iron	GG / Cast iron	GG / Cast iron	GG / Cast iron	GG / Cast iron
Duble pump / Zwillingspumpe		no / nein	yes / ja	no / nein	yes / ja	no / nein	no / nein
APPLICATIONS / EINSATZGEBIETE							
Heating / Warmwasserheizungen		✓	✓	✓	✓	✓	✓
Cooling / Kaltwasseranlagen		✓	✓	✓	✓	✓	✓
Sanitary water / Brauchwasser							
Climate appliances / Klimaanlage		✓	✓	✓	✓	✓	✓
Industry / Industrieanlagen							
Process technique / Verfahrenstechnik							
Condensation / Kondensat							
Salt water / Meerwasser							

Pump markings / Typenschlüssel

GHN D 25 / 60 - 130 (180)

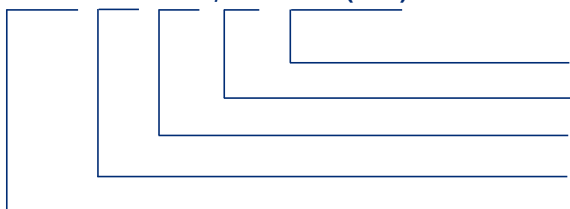

instalation lenght / einbaulänge
 max head / förderhöhe
 connection size / nennweite **DN**
 twin pump - **D** / zwillingsbauform- **D**
 circulating pump / Umwälzpumpe

GHN M D basic (auto) 40 - 120 F

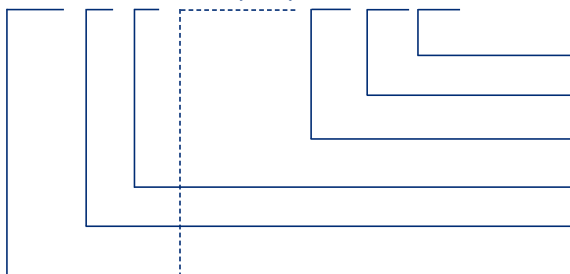

twin pump - **D** / zwillingsbauform- **D**
 connection type - **Flange** / Rohranschluss - Flansche
 max head / förderhöhe
 connection size / nennweite **DN**
 twin pump - **D** / zwillingsbauform- **D**
 mono-phases voltage / einphasenstrom
 pump type / pumpentyp

Permitted mounting positions / Einbaumöglichkeiten



Threaded circulation pumps with three speeds
Dreistufige Verschraubungsumwälzpumpen mit manueller
Drehzahlumschaltung

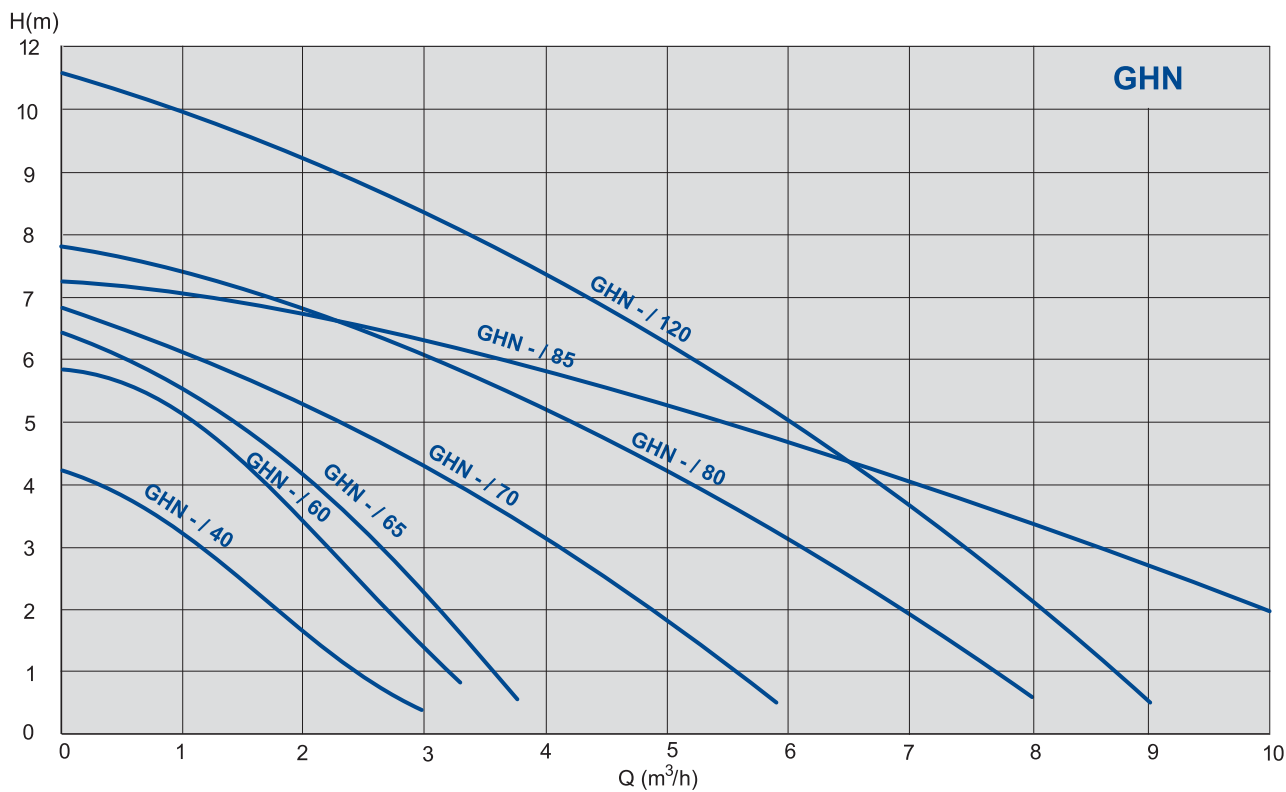
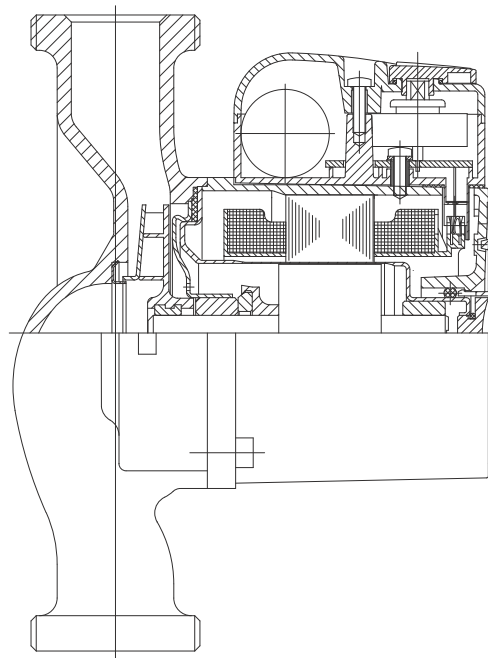

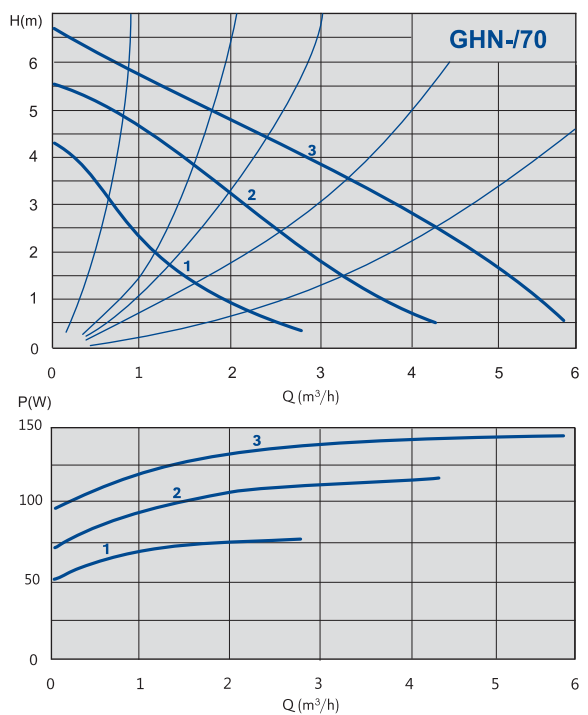
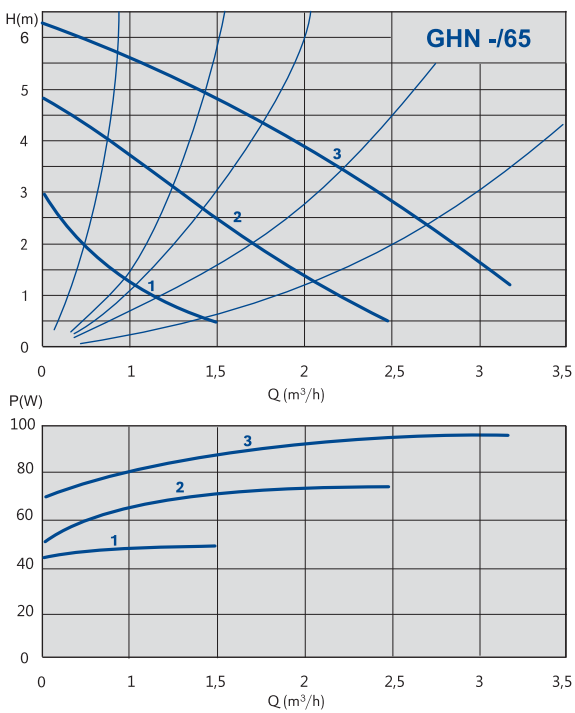
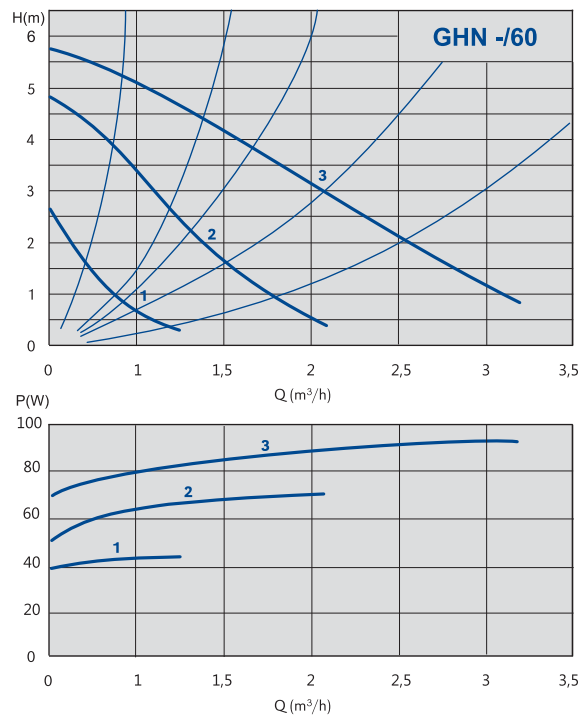
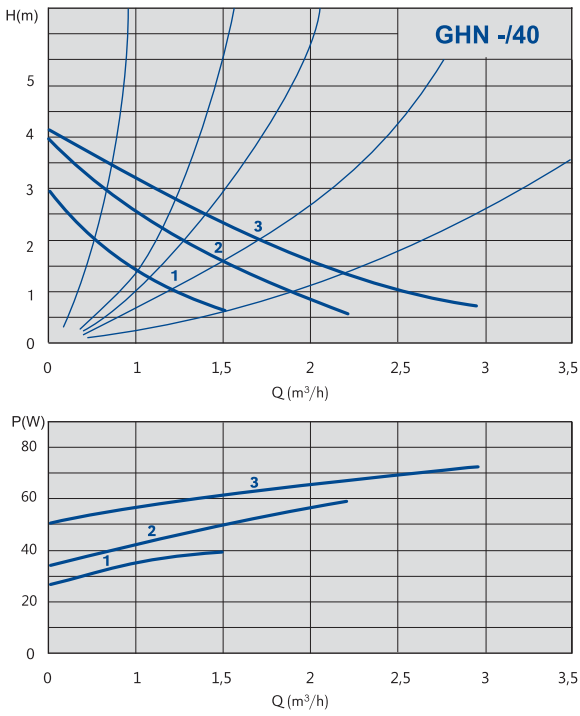

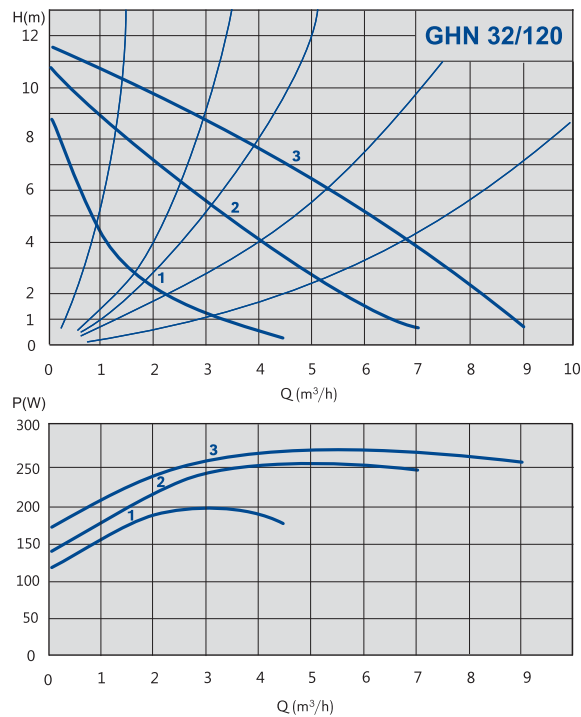
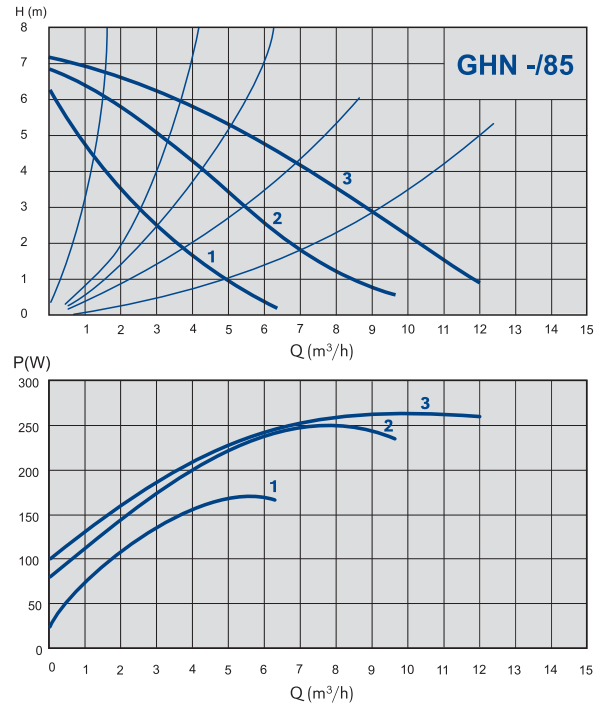
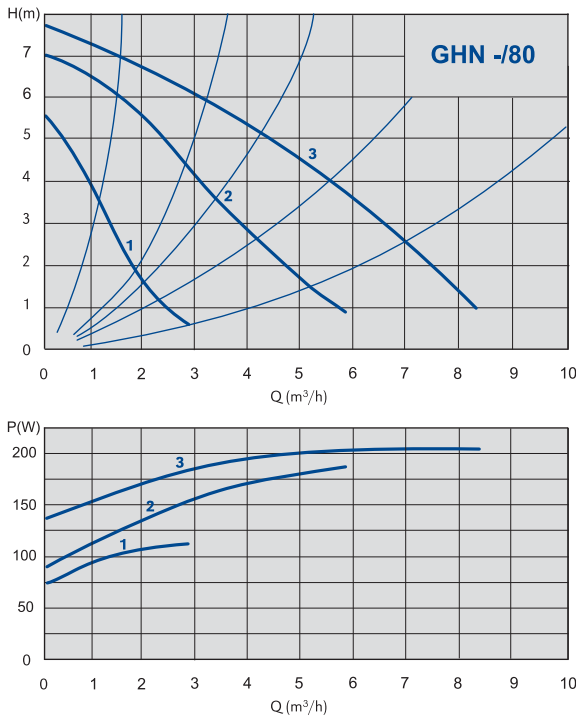

Threaded twin circulation pumps with three speeds
Dreistufige Zwilling Verschraubungsumwälzpumpen mit manueller Drehzahlumschaltung

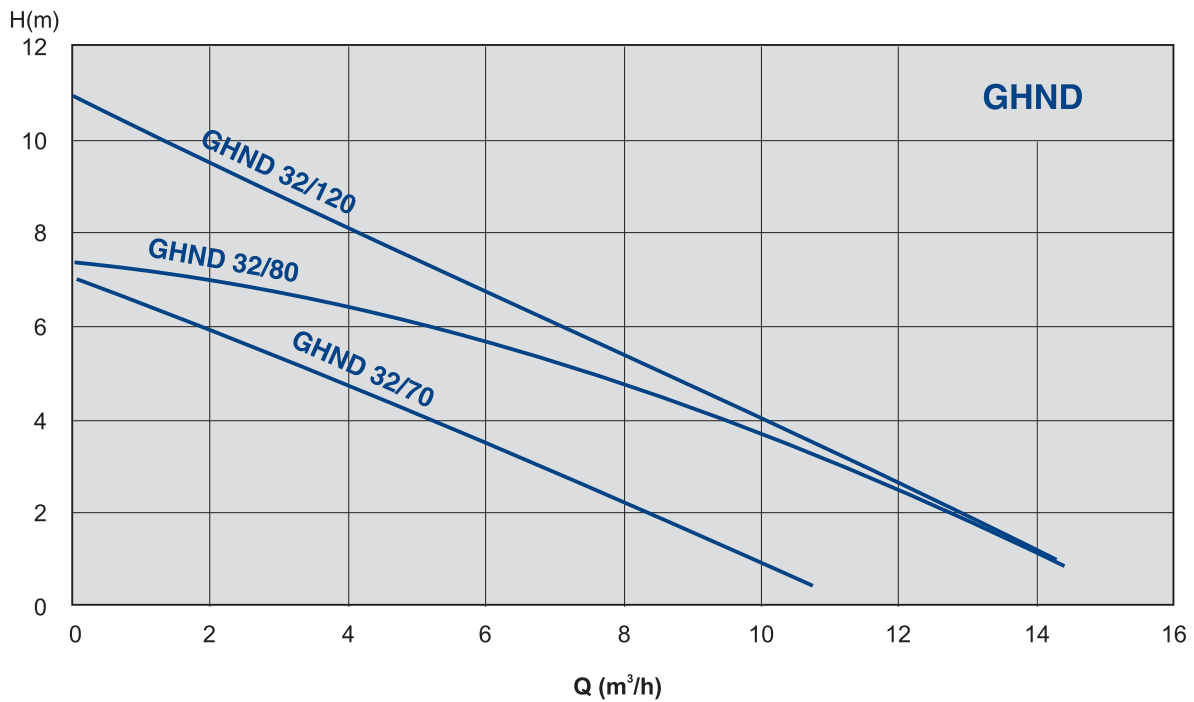
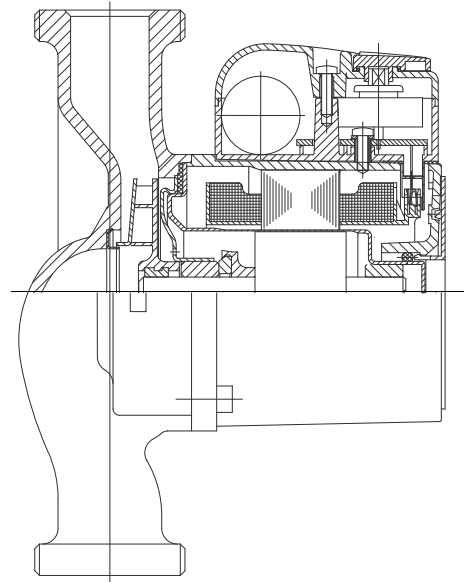

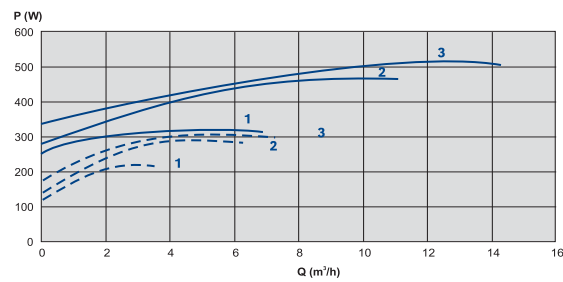
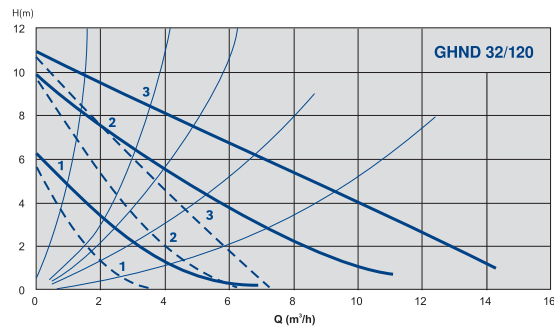
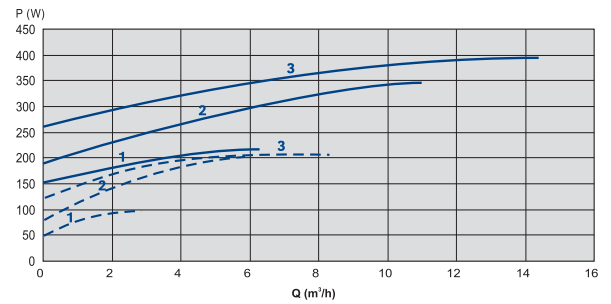
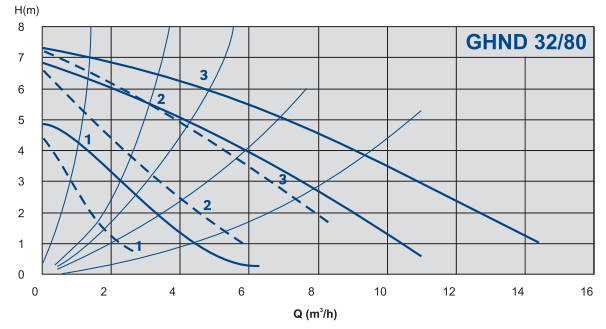
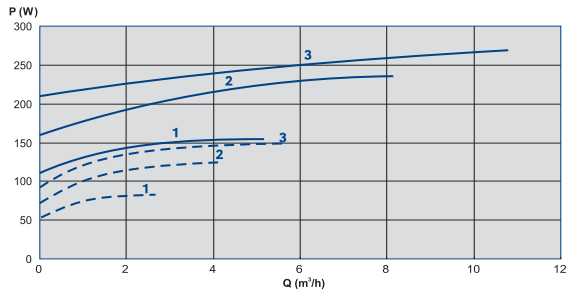
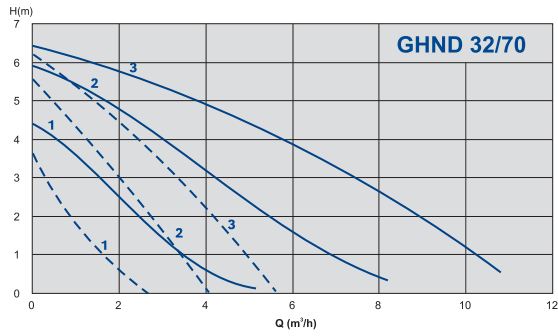
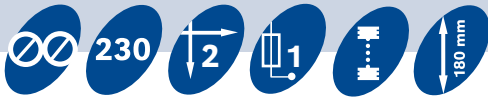

Three speeds circulation pumps with flanges - three-phases voltage
 Dreistufige Flanschumwälzpumpen mit manueller
 Drehzahlumschaltung - dreiphasenstrom

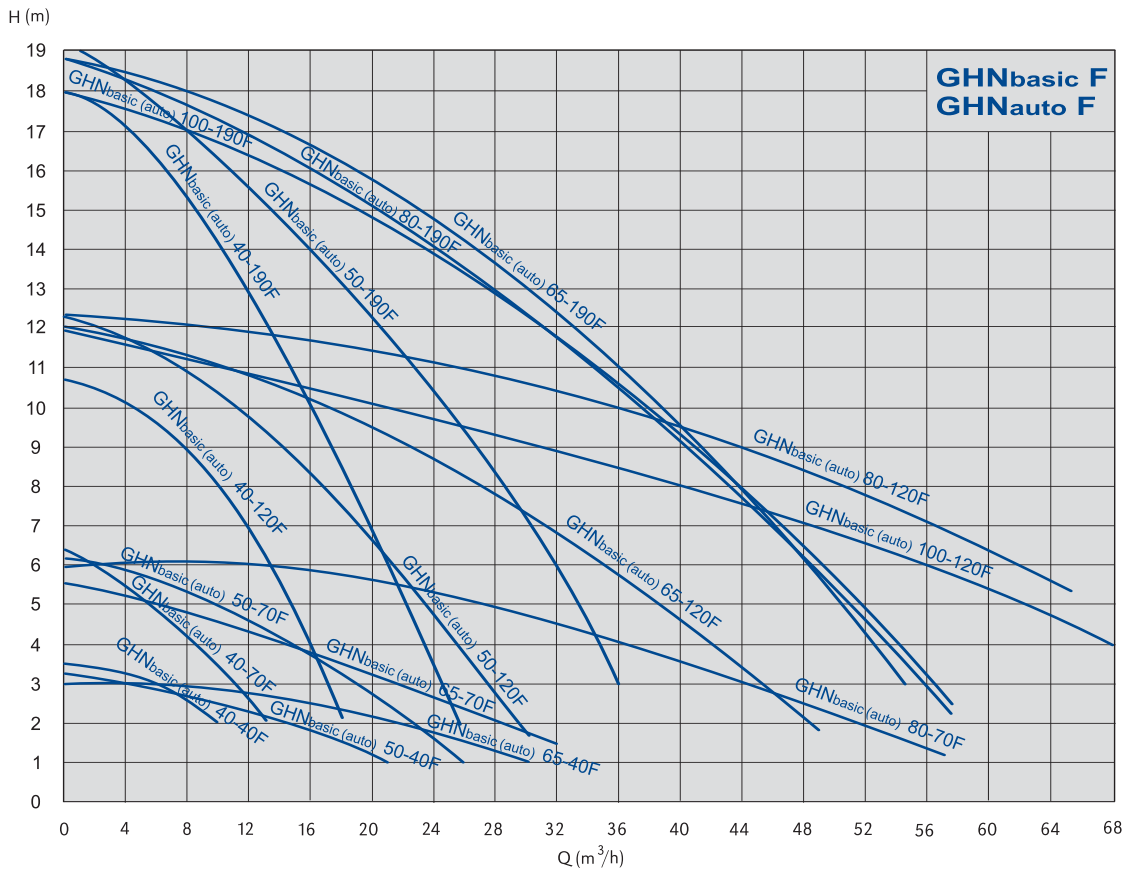
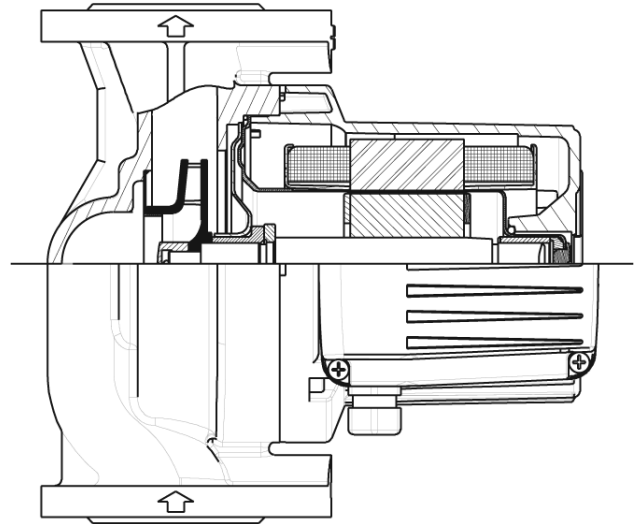

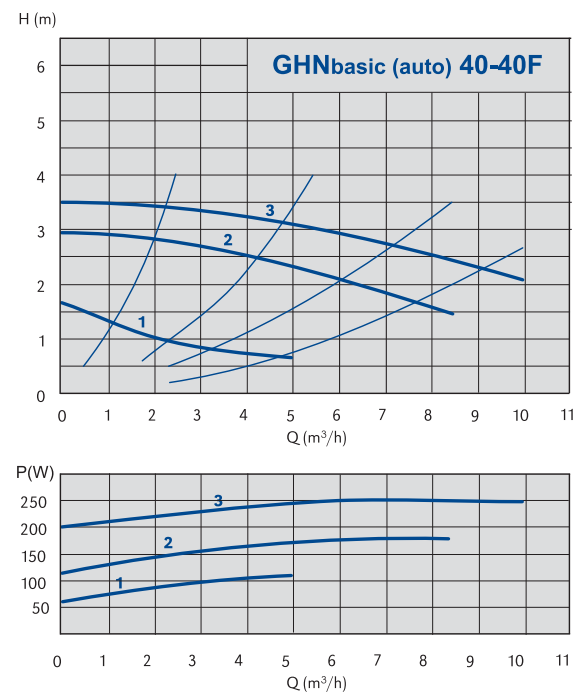
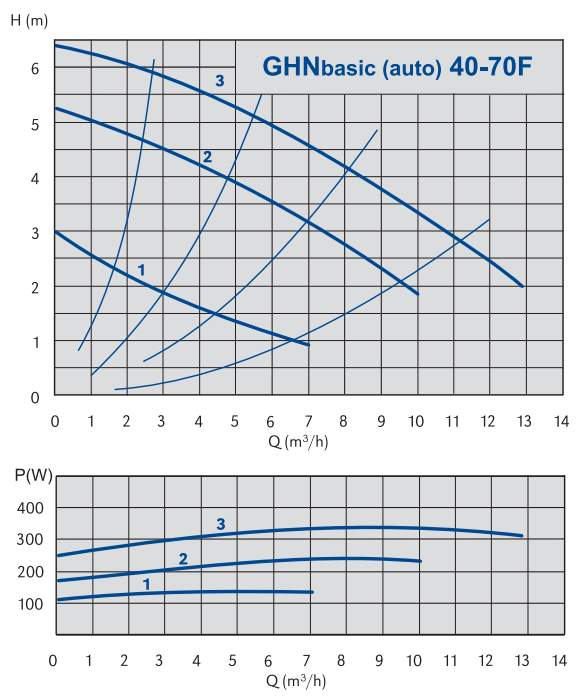
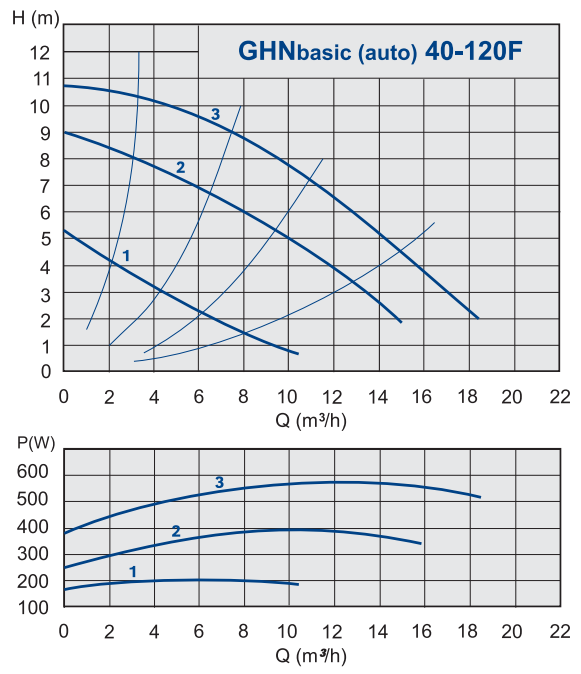
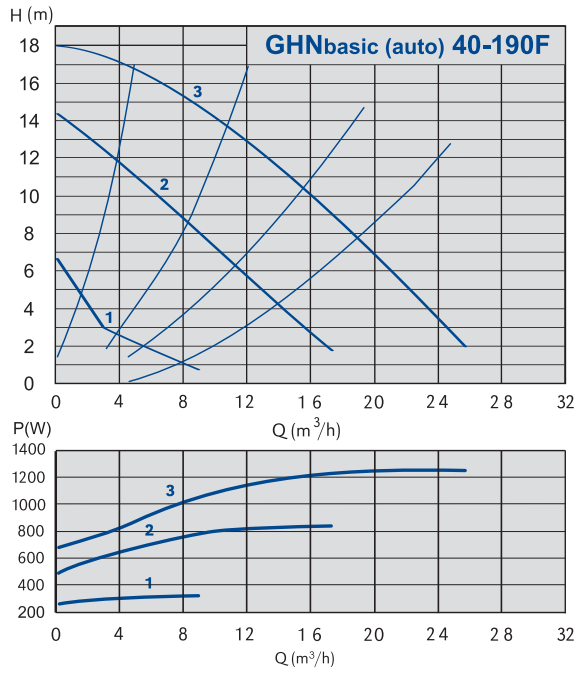

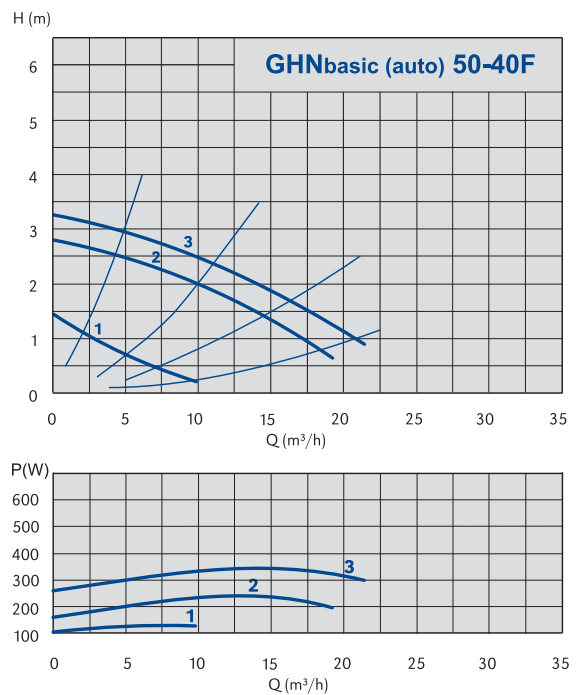
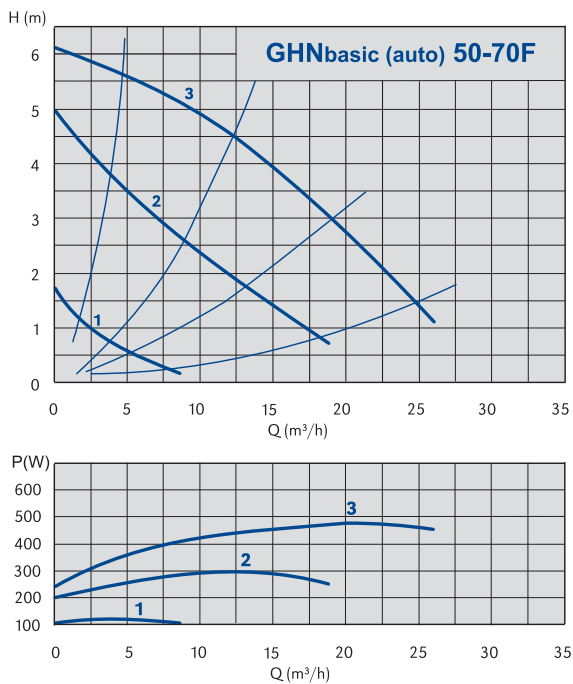
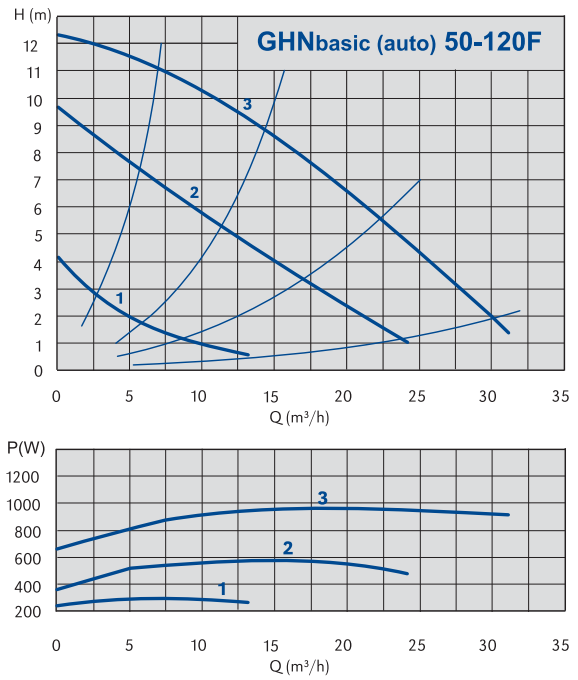
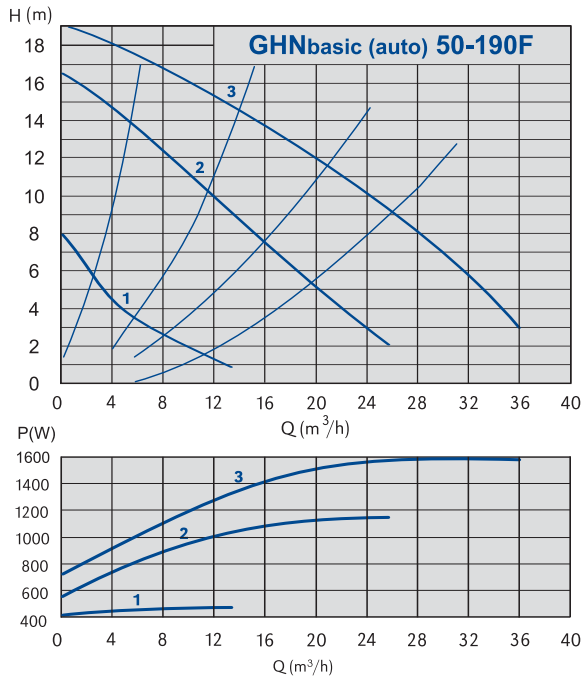

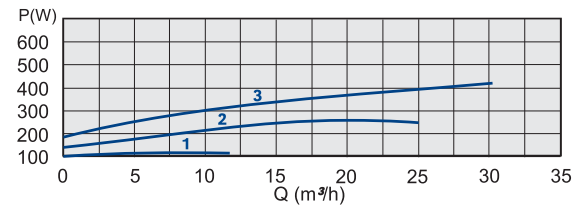
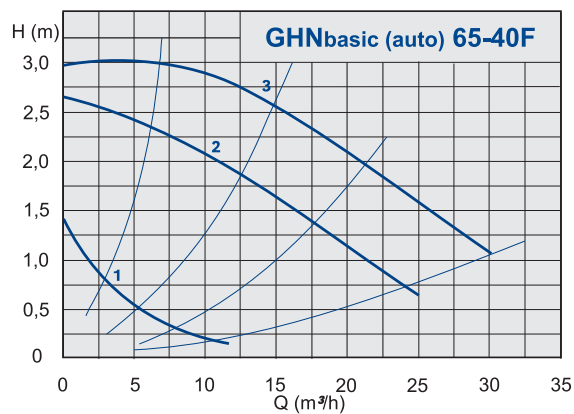
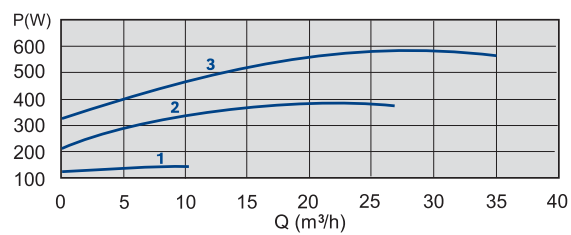
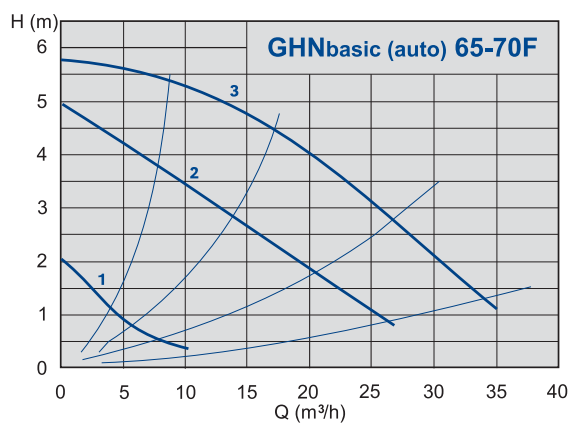
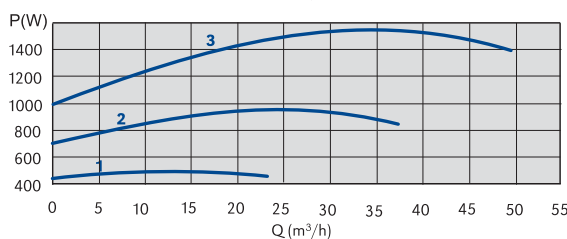
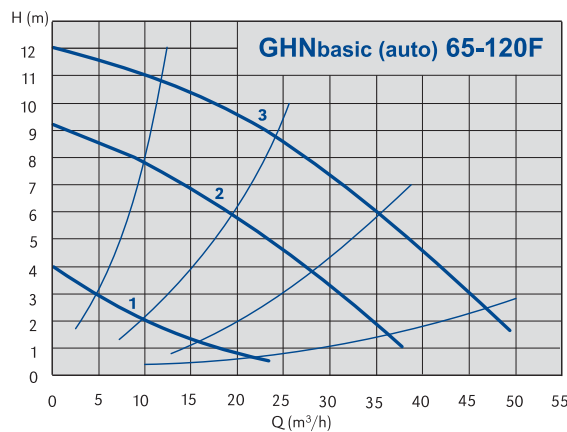
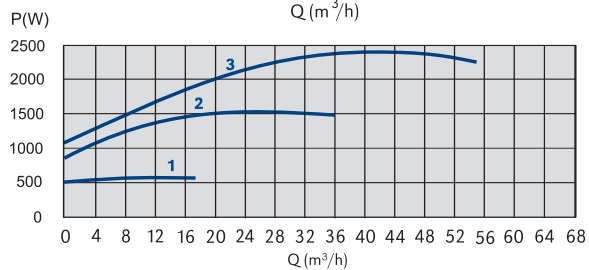
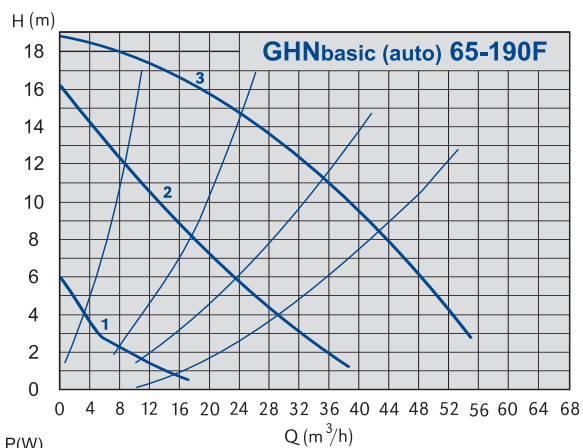

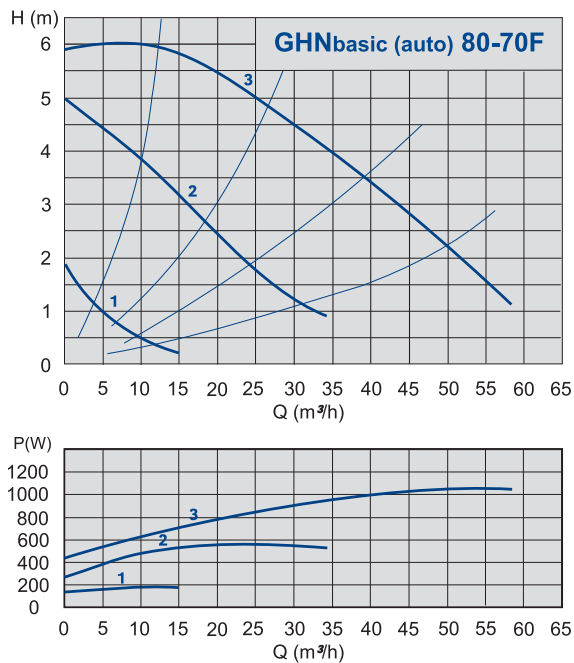
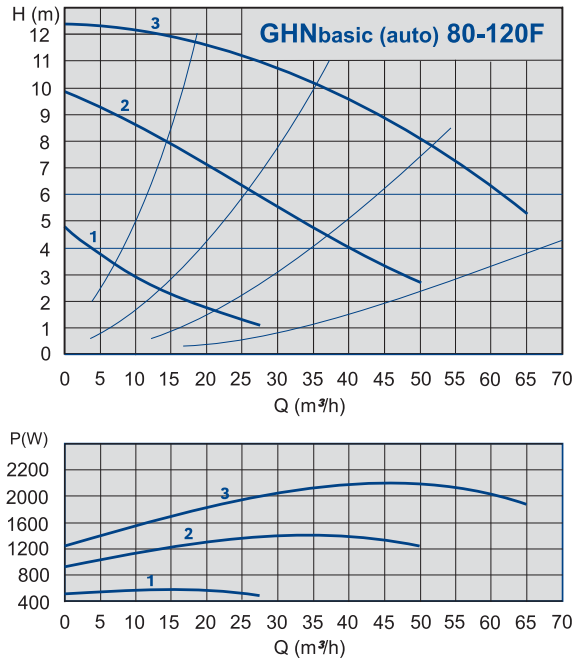
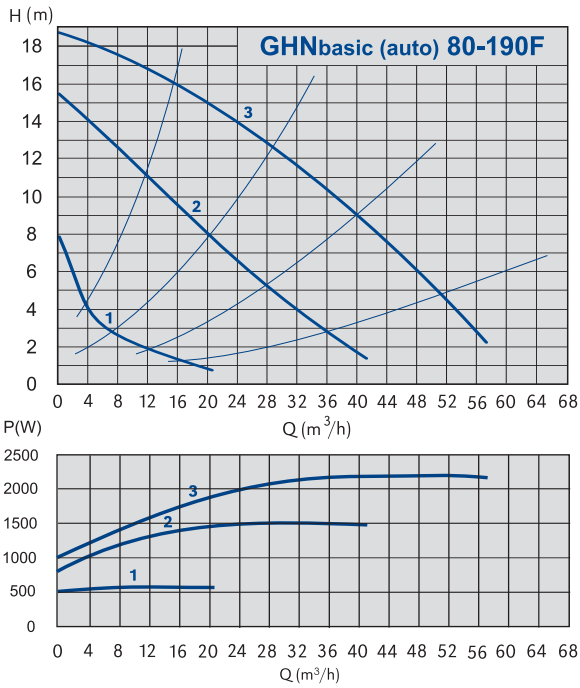

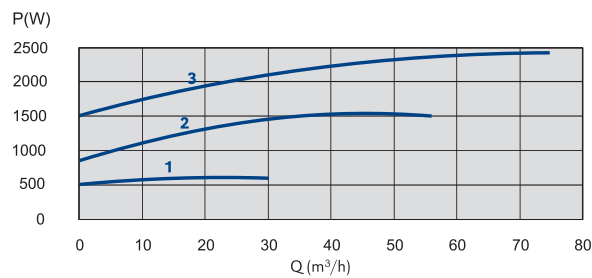
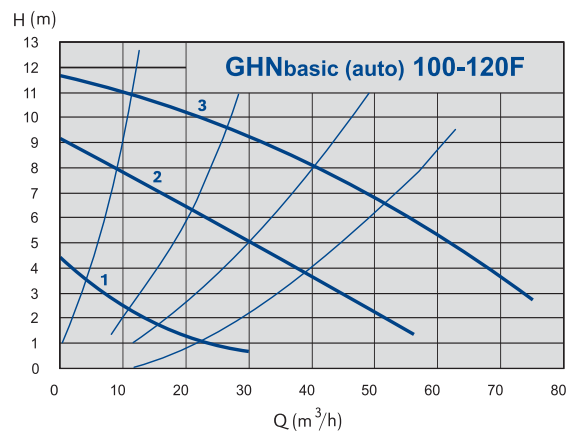
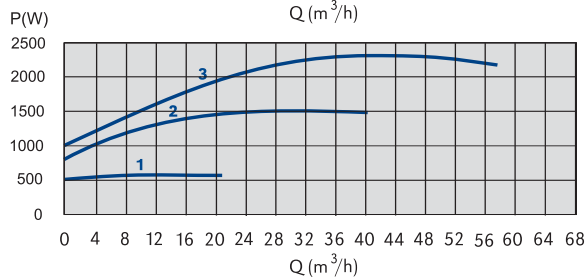
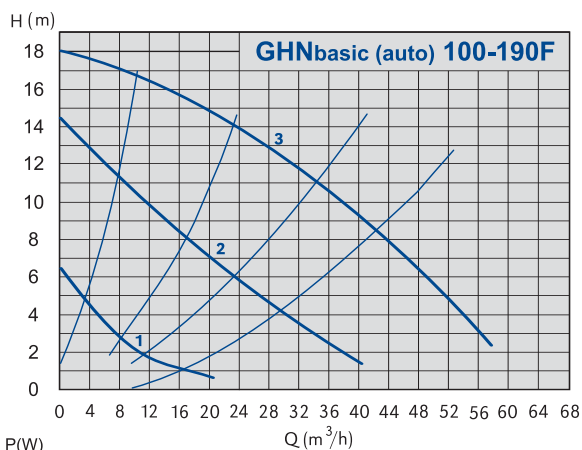

Three speeds twin circulation pumps with flanges - three-phases voltage
 Dreistufige Zwillingsumwälzpumpen mit manueller
 Drehzahlumschaltung - dreiphasenstrom

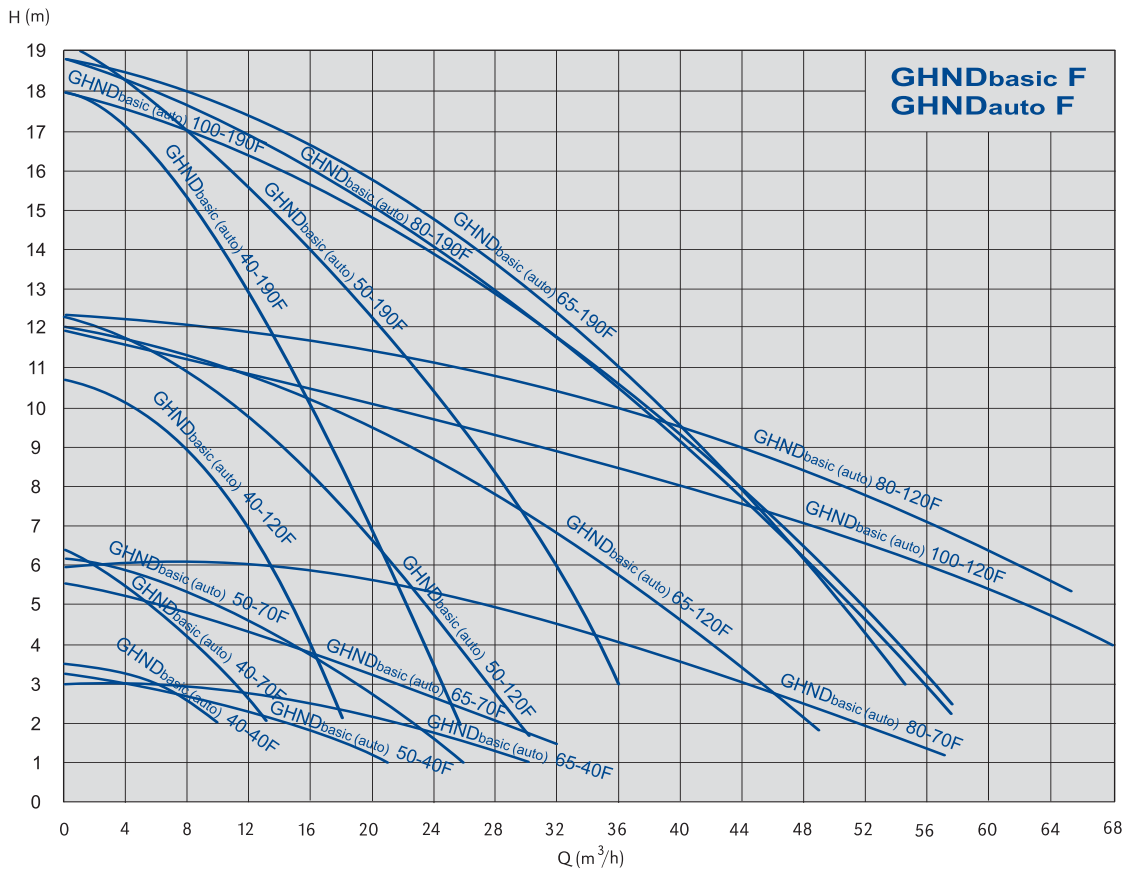
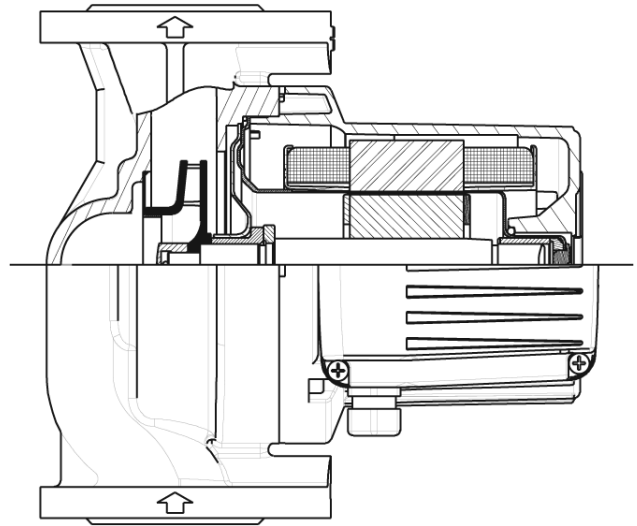

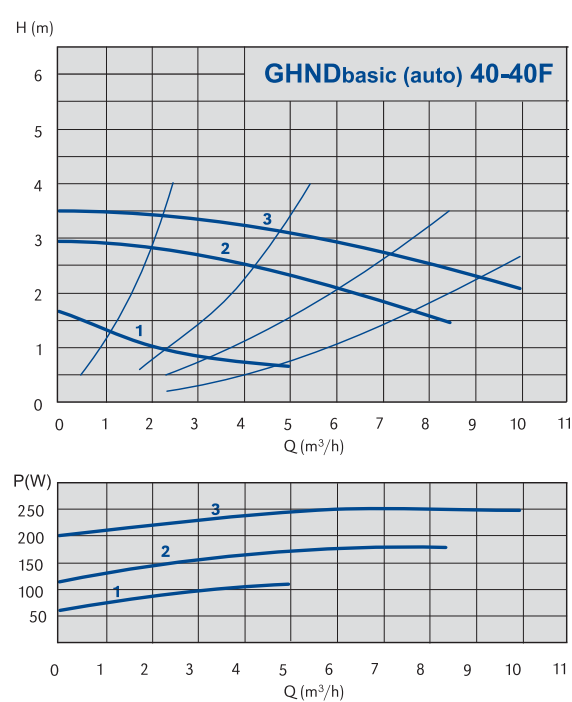
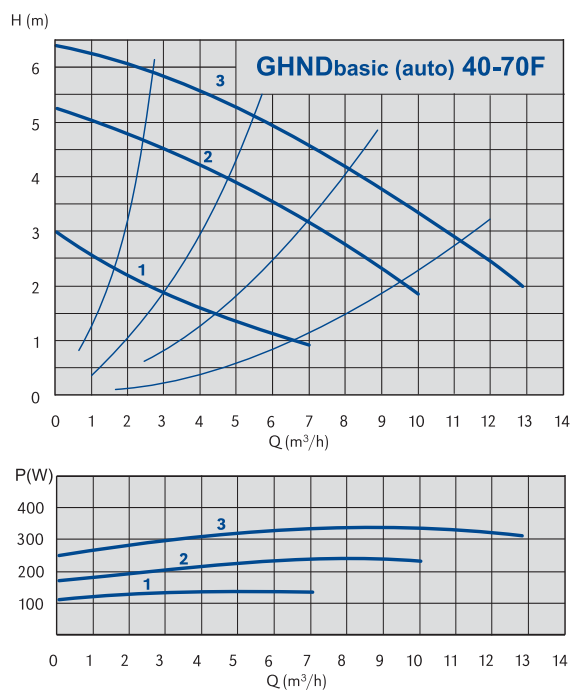
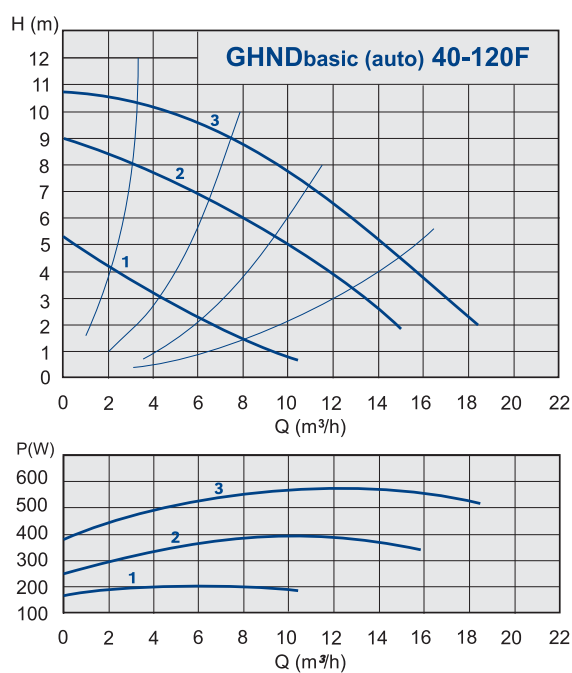
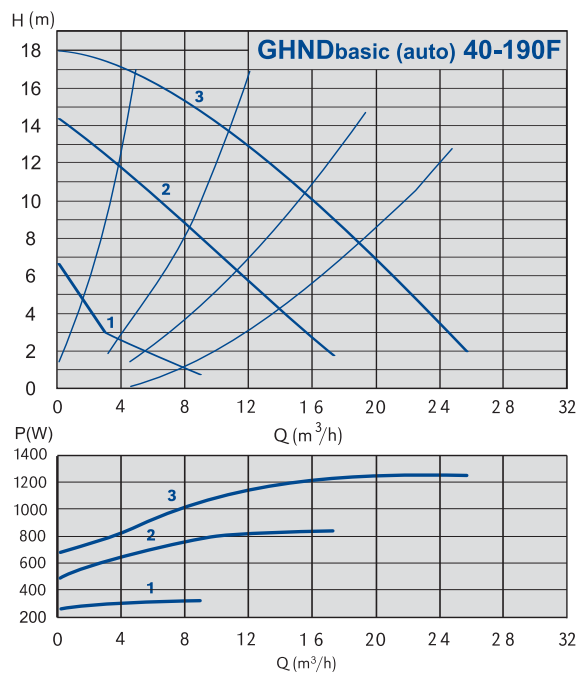

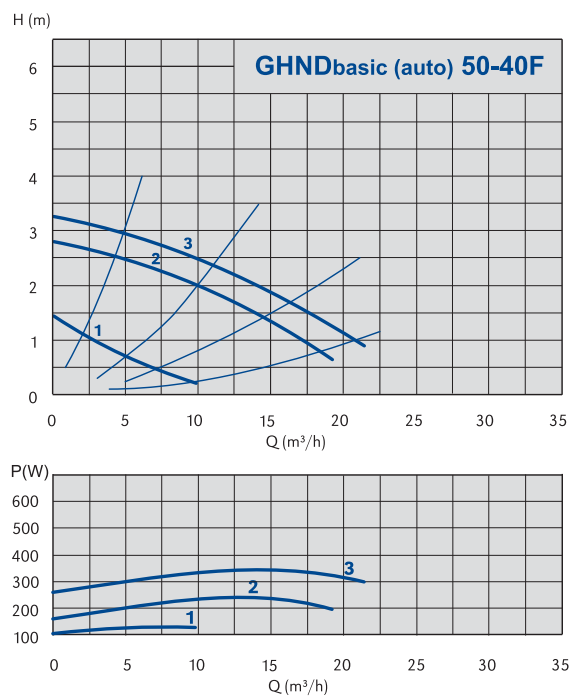
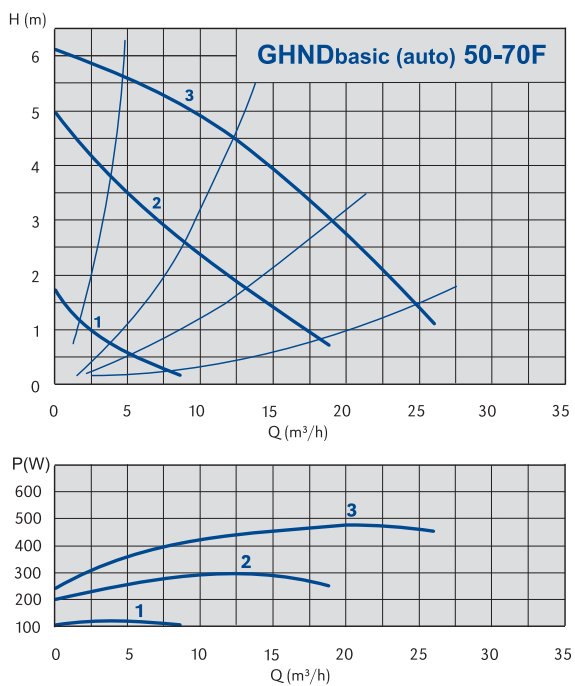
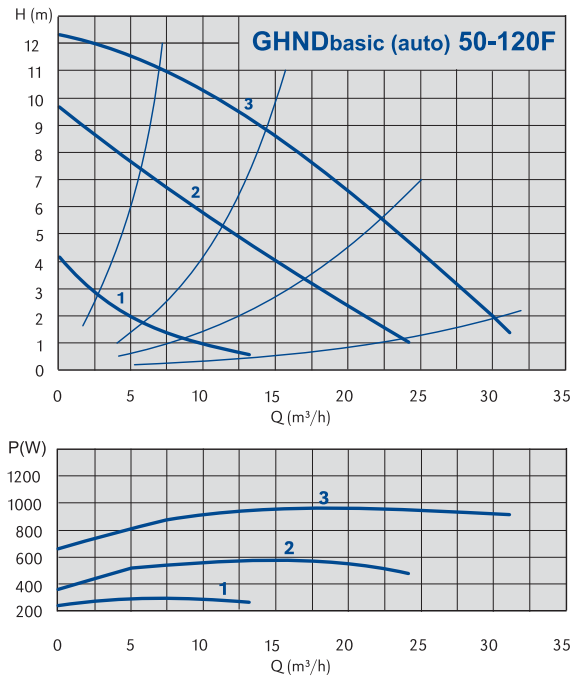
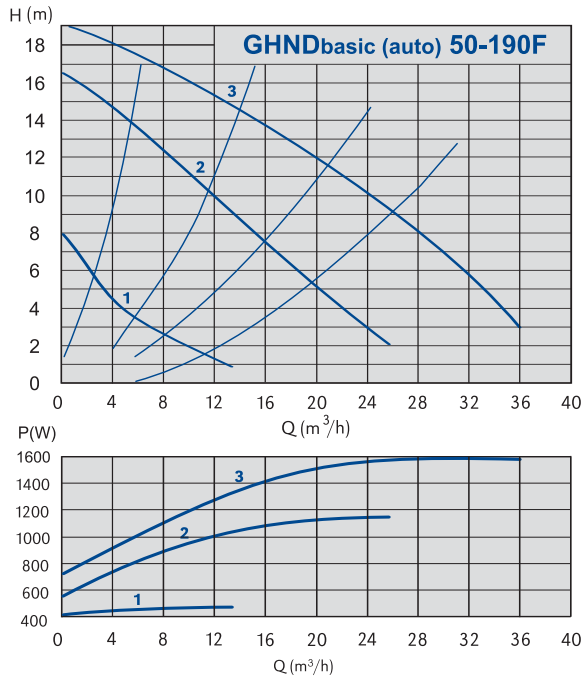

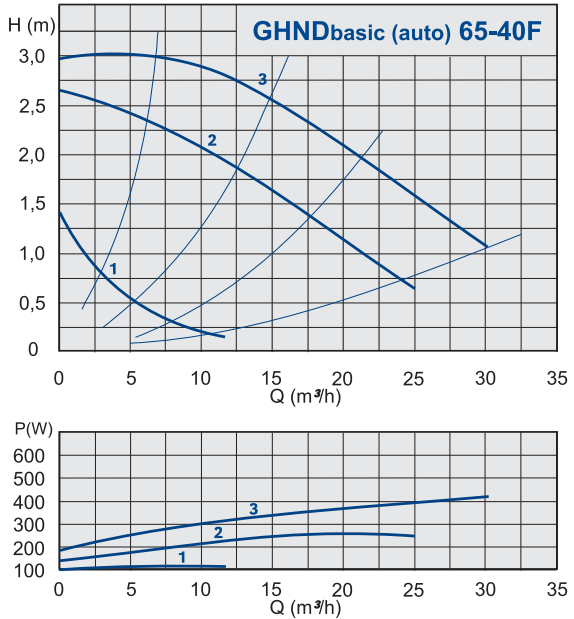
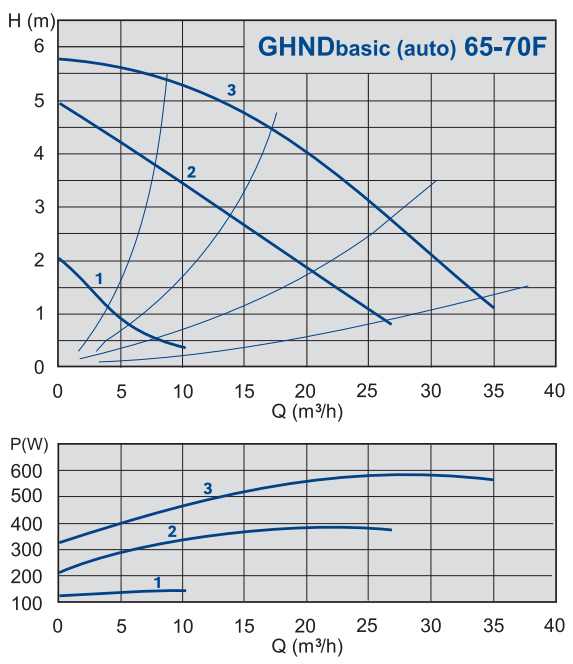
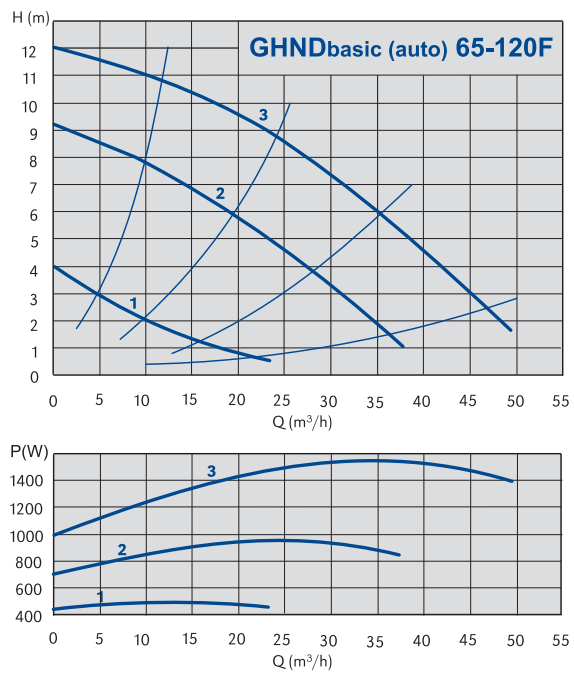
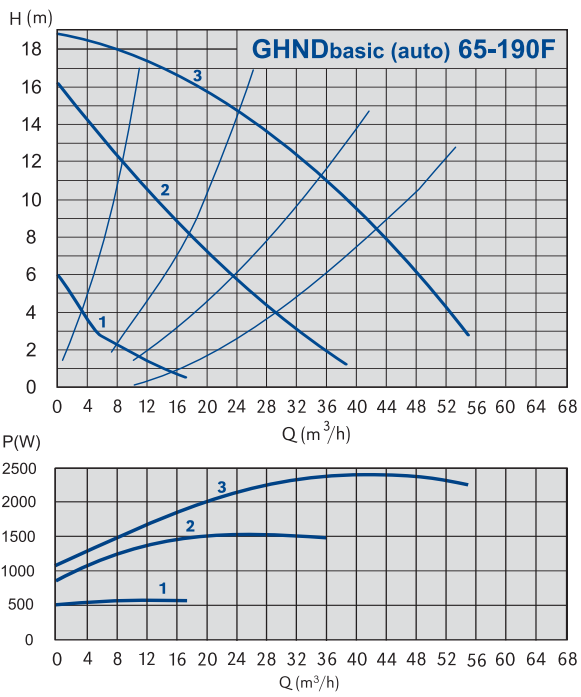

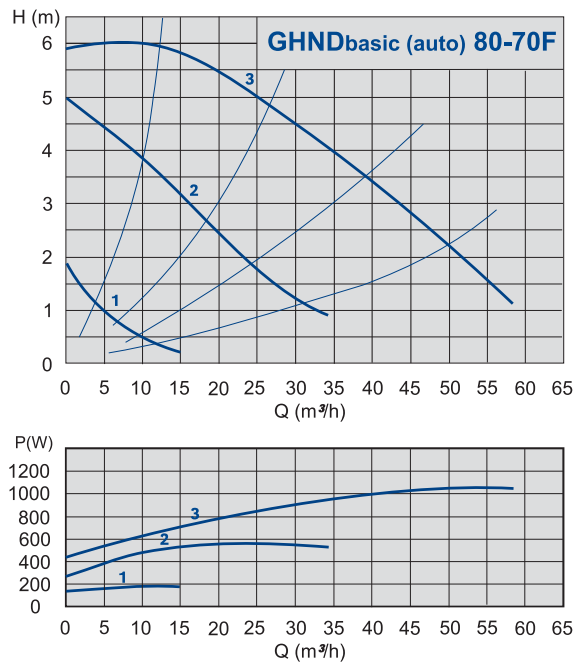
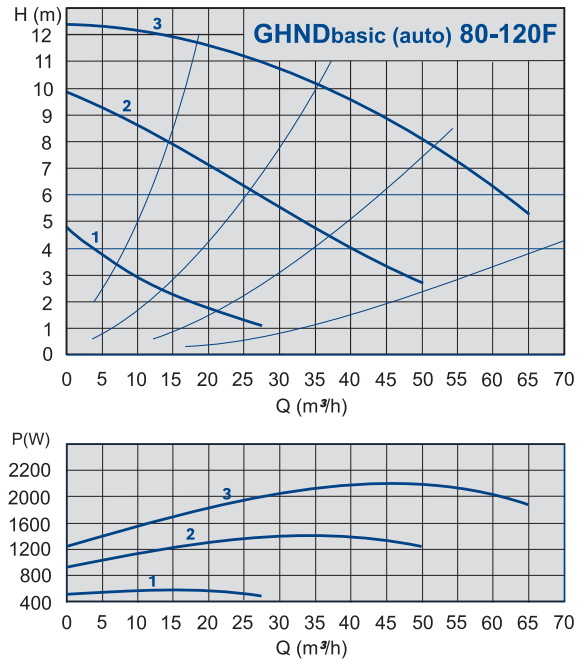
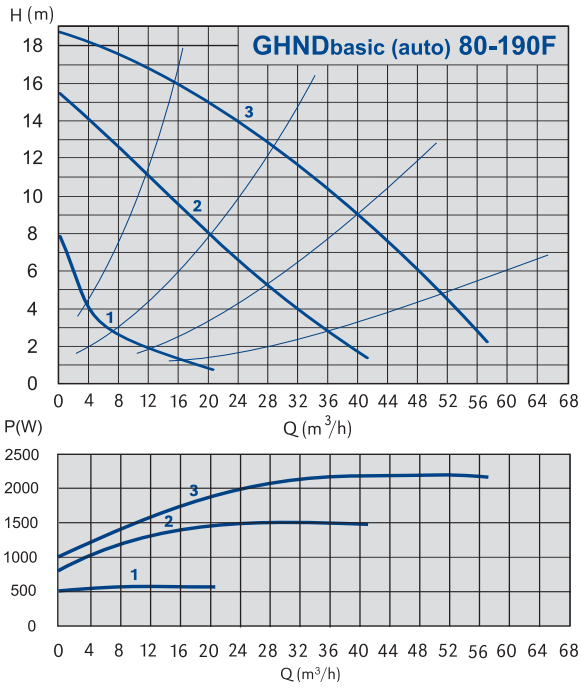

Three speeds circulation pumps with flanges - mono-phases voltage
Dreistufige Flanschumwälzpumpen mit manueller
Drehzahlumschaltung - einphasenstrom

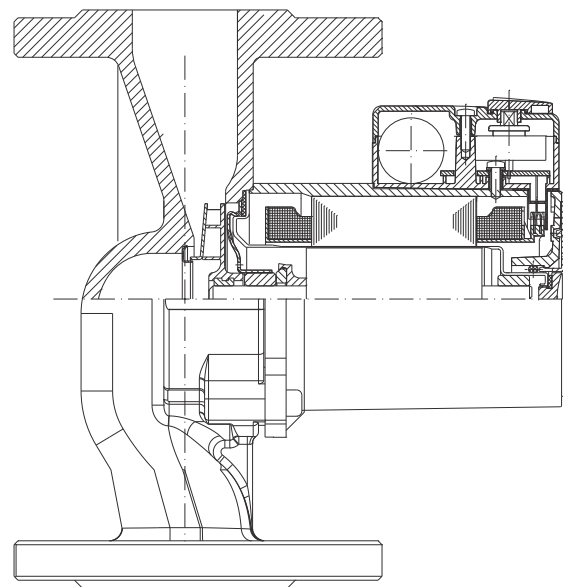

-
-
-
-
-

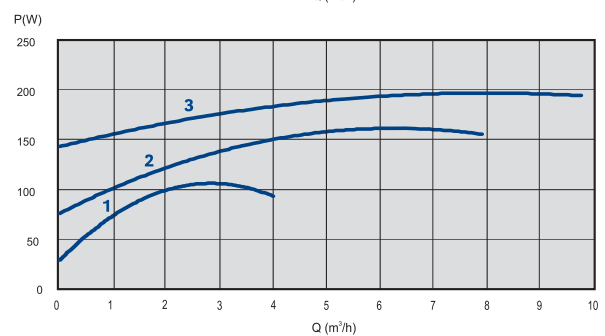
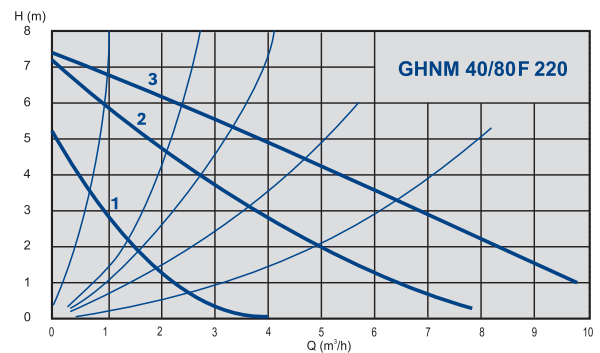
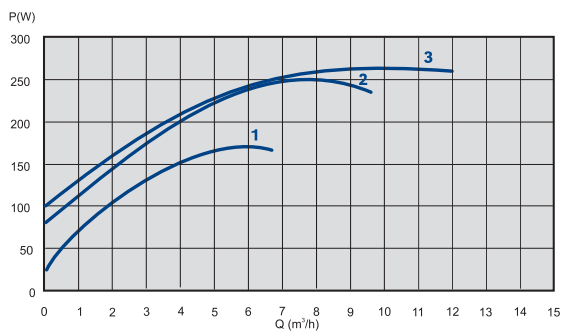
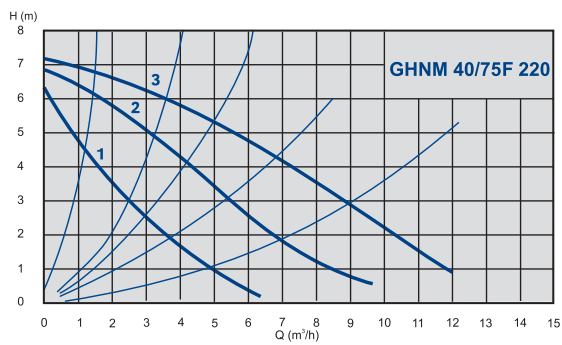

Three speeds circulation pumps with flanges - mono-phases voltage
 Dreistufige Flanschumwälzpumpen mit manueller
 Drehzahlumschaltung - einphasenstrom

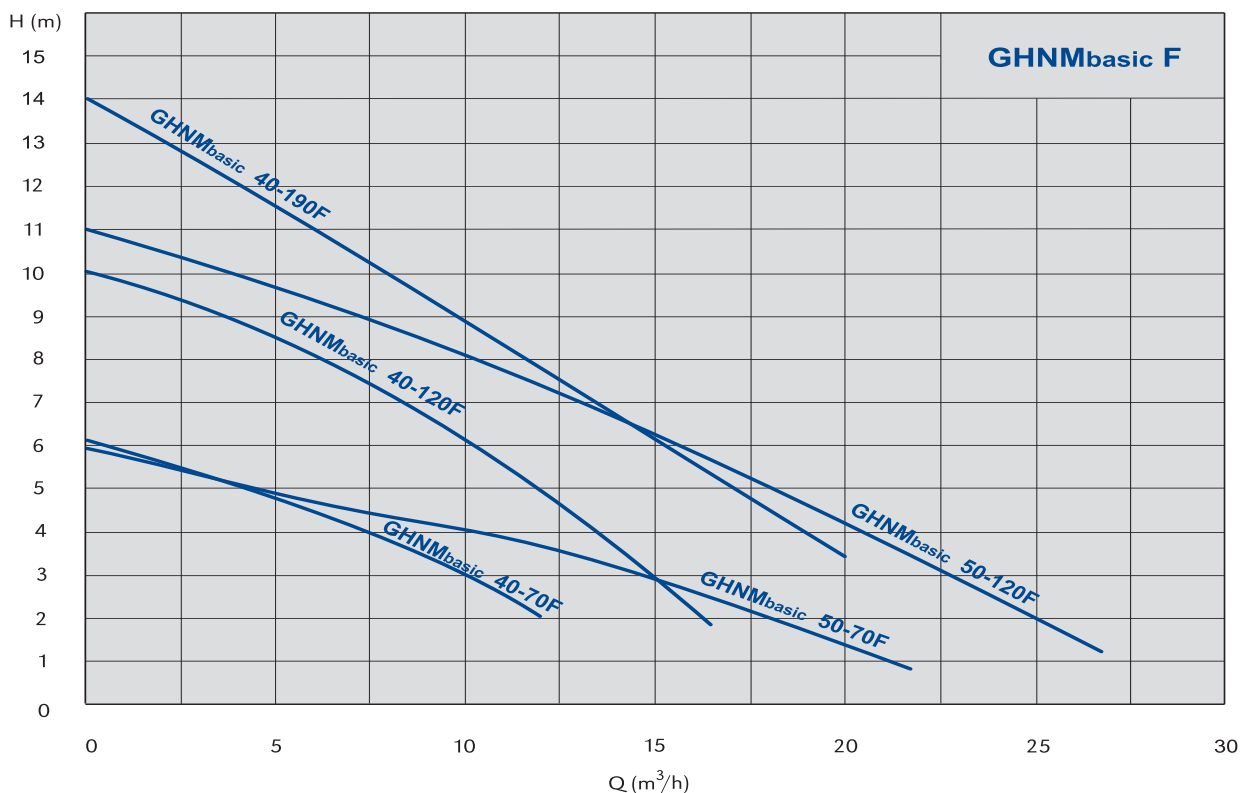
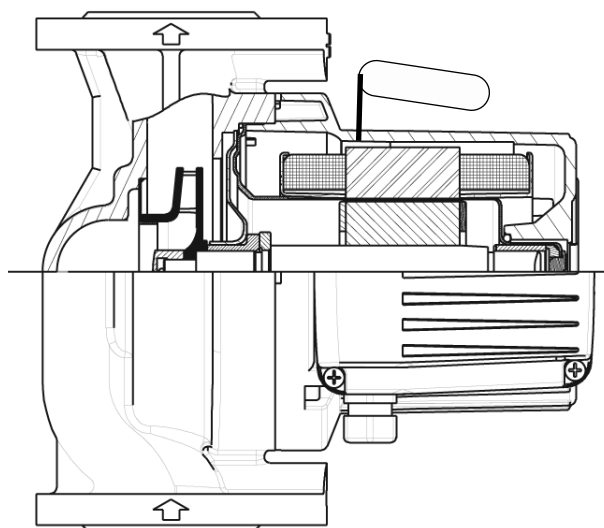

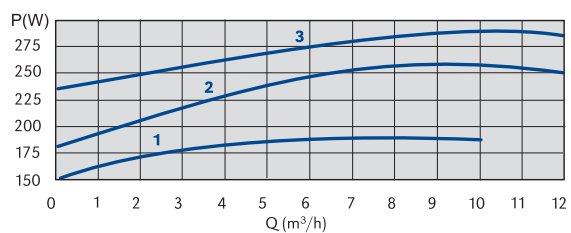
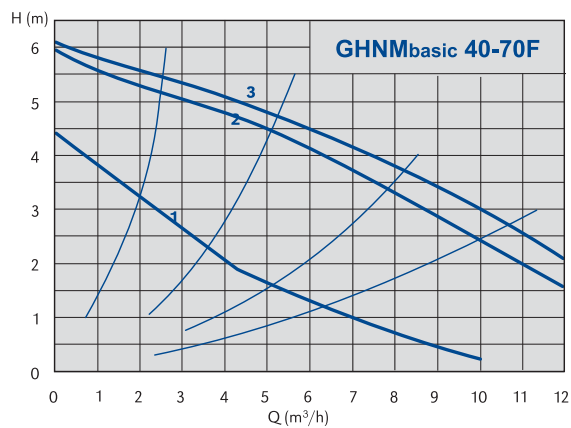
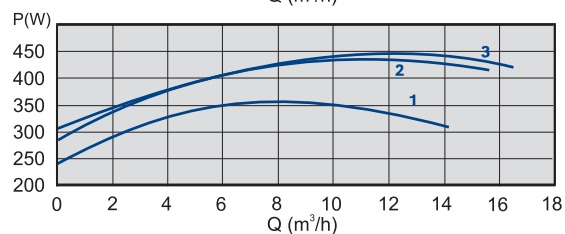
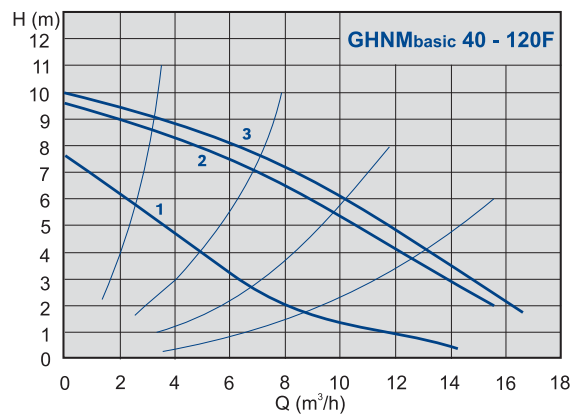
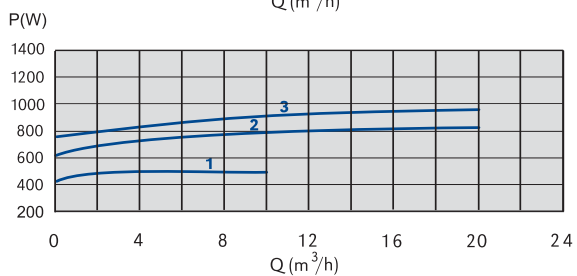
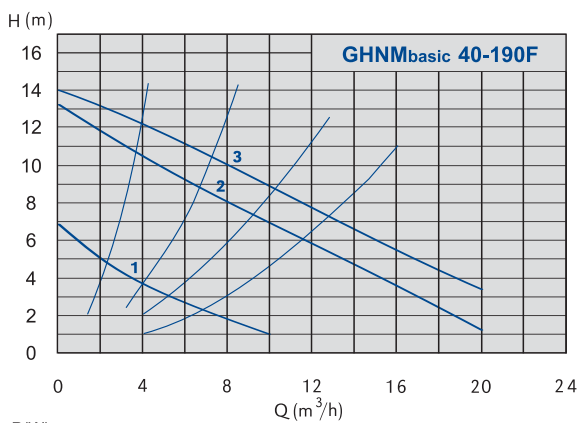

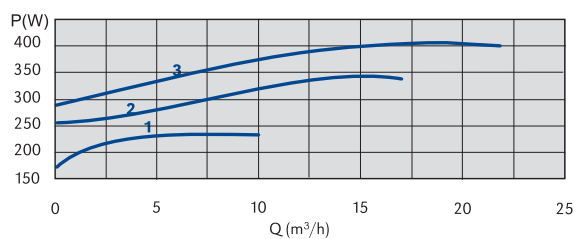
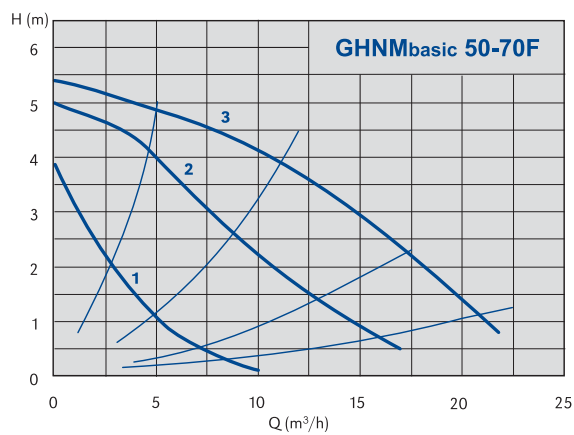
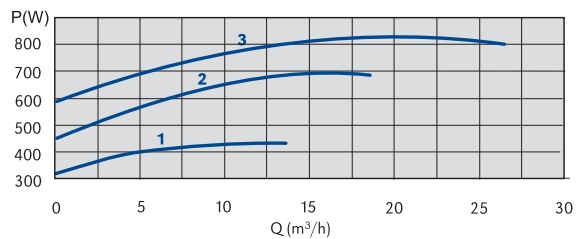
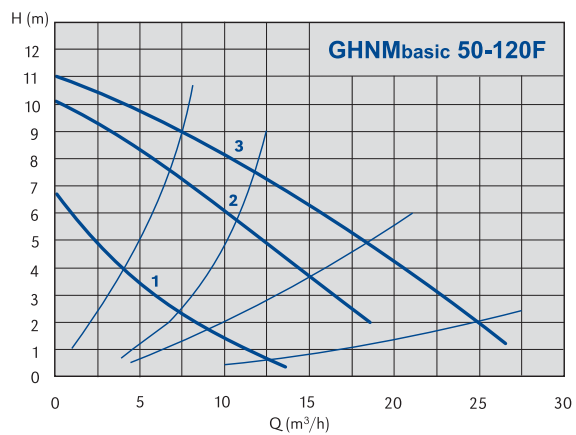

GHN / GHND
 GHNbasic (auto) F / GHNDbasic (auto) F
 GHNM F / GHNMbasic F / GHNMDbasic F

Three speeds twin circulation pumps with flanges - mono-phases voltage
Dreistufige Zwillingsumwälzpumpen mit manueller Drehzahlumschaltung
- einphasenstrom

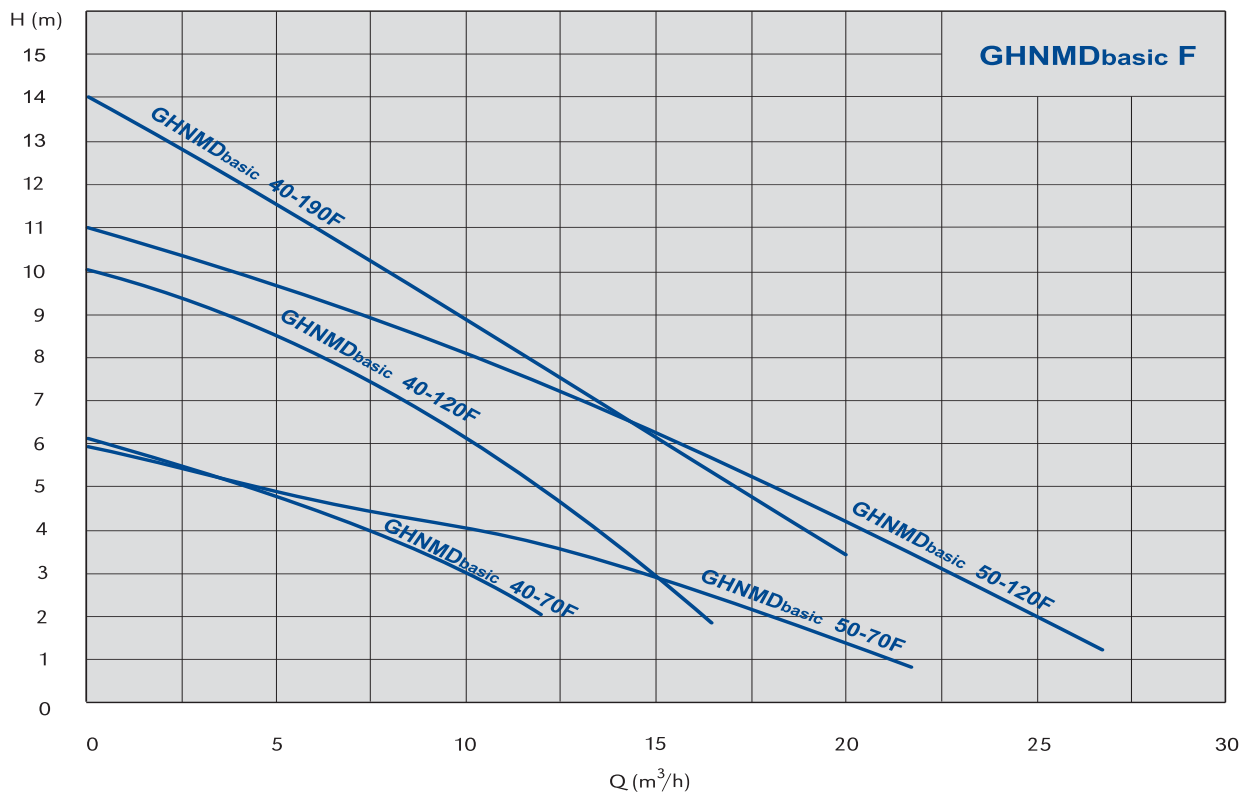
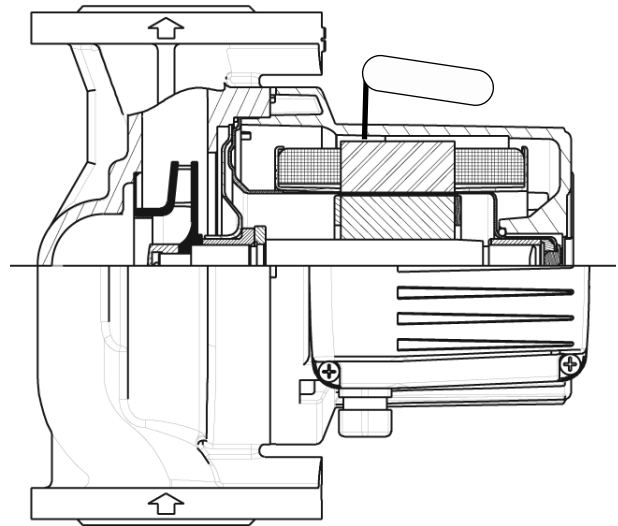

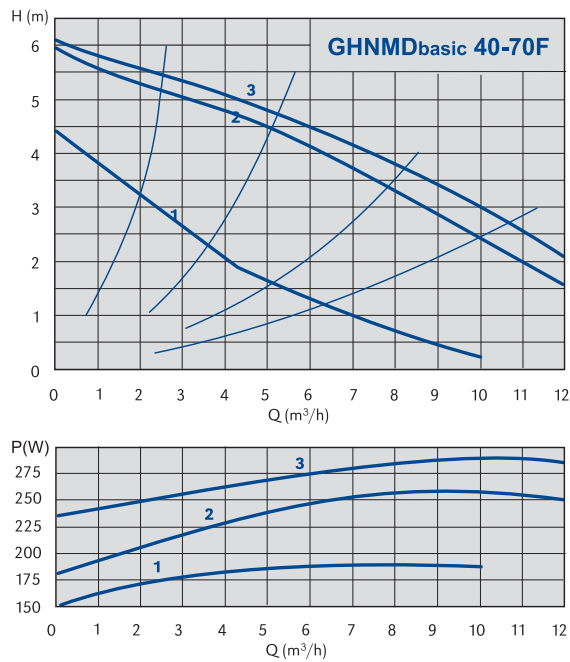
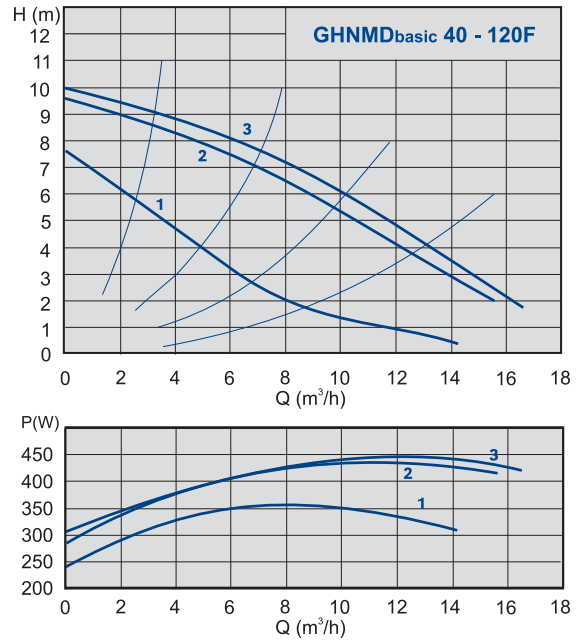
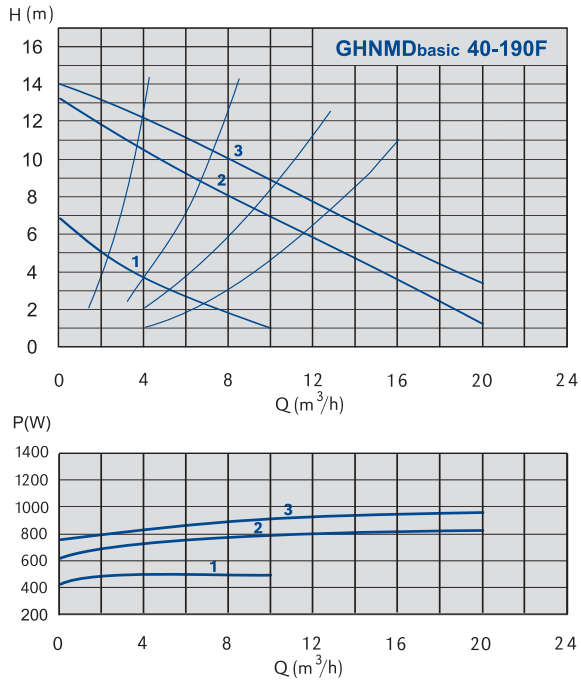

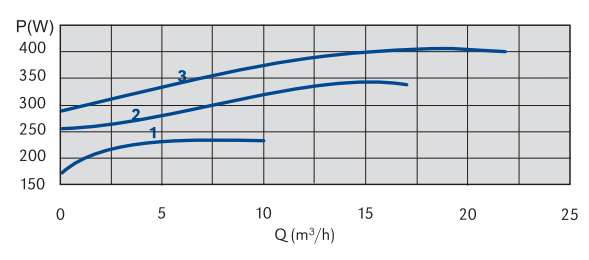
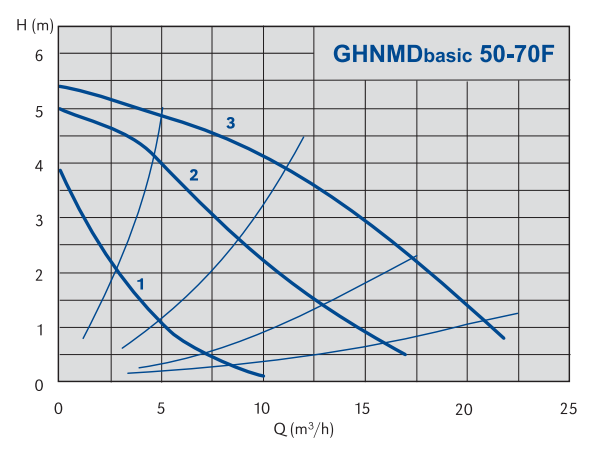
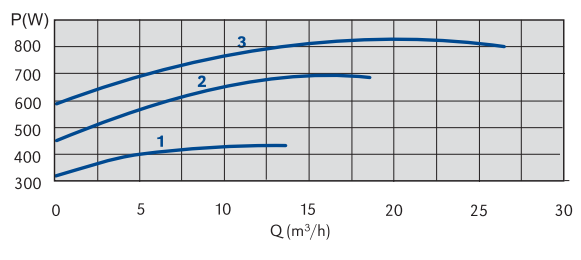
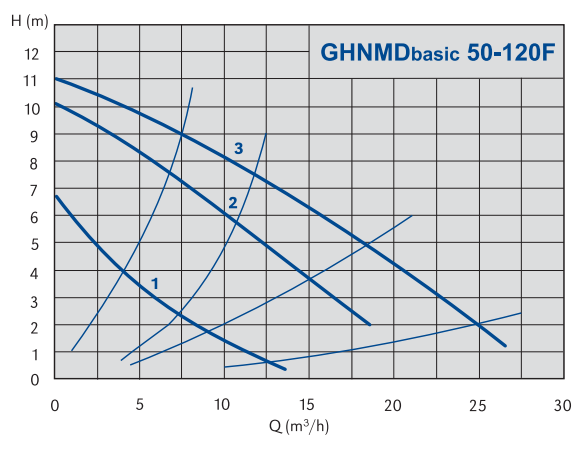

TEHNIICAL DATA / TECHNISCHE DATEN

pump type pumpentyp	code artikelnummer	connection type rohranschluss	max. flow durchfluss Q (m³/h)	max. Head Förder- höhe H (m)	system pressure systemdruck PN (bar)	min. - max. media temperature temp. des medius Tmin-Tmax (°C)	casing type werkstoffe GG / Cast iron	single-S double-D einzelne-E zwillings- bauform-Z	net weight Reinige- wicht (kg)	regulation geregelt yes /ja no /nein	degree of protection schutzart IP
GHN 15/40-130	979521960	Screw/Gewinde	3,5	4,0	PN 10	-10 – +110	GG/CI	S/E	2,2	no/nein	44
GHN 15/60-130	979521961	Screw/Gewinde	3,5	6,0	PN 10	-10 – +110	GG/CI	S/E	2,2	no/nein	44
GHN 15/65-130	979521962	Screw/Gewinde	4,0	6,5	PN 10	-10 – +110	GG/CI	S/E	2,2	no/nein	44
GHN 20/40-130	979521700	Screw/Gewinde	3,5	4,0	PN 10	-10 – +110	GG/CI	S/E	2,3	no/nein	44
GHN 25/40-130	979521701	Screw/Gewinde	3,5	4,0	PN 10	-10 – +110	GG/CI	S/E	2,3	no/nein	44
GHN 20/60-130	979521702	Screw/Gewinde	3,5	6,0	PN 10	-10 – +110	GG/CI	S/E	2,3	no/nein	44
GHN 25/60-130	979521703	Screw/Gewinde	3,5	6,0	PN 10	-10 – +110	GG/CI	S/E	2,3	no/nein	44
GHN 20/65-130	979521706	Screw/Gewinde	4,0	6,5	PN 10	-10 – +110	GG/CI	S/E	2,3	no/nein	44
GHN 25/65-130	979521707	Screw/Gewinde	4,0	6,5	PN 10	-10 – +110	GG/CI	S/E	2,4	no/nein	44
GHN 20/40-180	979521709	Screw/Gewinde	3,5	4,0	PN 10	-10 – +110	GG/CI	S/E	2,5	no/nein	44
GHN 25/40-180	979521710	Screw/Gewinde	3,5	4,0	PN 10	-10 – +110	GG/CI	S/E	2,5	no/nein	44
GHN 32/40-180	979521711	Screw/Gewinde	3,5	4,0	PN 10	-10 – +110	GG/CI	S/E	2,75	no/nein	44
GHN 20/60-180	979521712	Screw/Gewinde	3,5	6,0	PN 10	-10 – +110	GG/CI	S/E	2,5	no/nein	44
GHN 25/60-180	979521713	Screw/Gewinde	3,5	6,0	PN 10	-10 – +110	GG/CI	S/E	2,5	no/nein	44
GHN 32/60-180	979521714	Screw/Gewinde	3,5	6,0	PN 10	-10 – +110	GG/CI	S/E	2,75	no/nein	44
GHN 25/65-180	979521704	Screw/Gewinde	4,0	6,5	PN 10	-10 – +110	GG/CI	S/E	2,6	no/nein	44
GHN 32/65-180	979521705	Screw/Gewinde	4,0	6,5	PN 10	-10 – +110	GG/CI	S/E	2,75	no/nein	44
GHN 25/70-180	979521987	Screw/Gewinde	6,0	6,8	PN 10	-10 – +110	GG/CI	S/E	2,75	no/nein	44
GHN 32/70-180	979521983	Screw/Gewinde	6,0	6,8	PN 10	-10 – +110	GG/CI	S/E	2,9	no/nein	44
GHN 25/80-180	979523206	Screw/Gewinde	8,4	8,0	PN 10	-10 – +110	GG/CI	S/E	4,6	no/nein	44
GHN 32/80-180	979521944	Screw/Gewinde	8,4	8,0	PN 10	-10 – +110	GG/CI	S/E	4,7	no/nein	44
GHN 32/85-180	979522752	Screw/Gewinde	12	7,1	PN 10	-10 – +110	GG/CI	S/E	5,3	no/nein	44
GHN 32/120-180	979522005	Screw/Gewinde	9,5	12	PN 10	-10 – +110	GG/CI	S/E	5,4	no/nein	44
GHND 32/70-180	979522021	Screw/Gewinde	10,8	6,4	PN 10	-10 – +110	GG/CI	D/Z	5,9	no/nein	44
GHND 32/80-180	979522022	Screw/Gewinde	14,4	7,3	PN 10	-10 – +110	GG/CI	D/Z	9,4	no/nein	44
GHND 32/120-180	979522023	Screw/Gewinde	14,3	10,8	PN 10	-10 – +110	GG/CI	D/Z	10,2	no/nein	44
GHNbasic 40-190F	979523262	Flanges/Flansche	27	18	PN 6 / 10	-10 – +110	GG/CI	S/E	22	no/nein	43
GHNbasic 40-120F	979522802	Flanges/Flansche	20	12	PN 6 / 10	-10 – +120	GG/CI	S/E	17,9	no/nein	43
GHNbasic 40-70F	979522803	Flanges/Flansche	13	6	PN 6 / 10	-10 – +120	GG/CI	S/E	17,7	no/nein	43
GHNbasic 40-40F	979522804	Flanges/Flansche	10	3,5	PN 6 / 10	-10 – +120	GG/CI	S/E	17,4	no/nein	43
GHNbasic 50-190F	979523264	Flanges/Flansche	37	19,5	PN 6 / 10	-10 – +110	GG/CI	S/E	26,3	no/nein	43
GHNbasic 50-120F	979522805	Flanges/Flansche	30	12	PN 6 / 10	-10 – +120	GG/CI	S/E	24,6	no/nein	43
GHNbasic 50-70F	979522806	Flanges/Flansche	25	6	PN 6 / 10	-10 – +120	GG/CI	S/E	24,3	no/nein	43
GHNbasic 50-40F	979522807	Flanges/Flansche	20	3,5	PN 6 / 10	-10 – +120	GG/CI	S/E	24	no/nein	43
GHNbasic 65-190F	979523265	Flanges/Flansche	57	18,5	PN 6 / 10	-10 – +110	GG/CI	S/E	31,4	no/nein	43
GHNbasic 65-120F	979522808	Flanges/Flansche	50	12	PN 6 / 10	-10 – +120	GG/CI	S/E	30,8	no/nein	43
GHNbasic 65-70F	979522809	Flanges/Flansche	35	6	PN 6 / 10	-10 – +120	GG/CI	S/E	28,6	no/nein	43
GHNbasic 65-40F	979522810	Flanges/Flansche	33	3,5	PN 6 / 10	-10 – +120	GG/CI	S/E	28,6	no/nein	43
GHNbasic 80-190F PN 6	979523314	Flanges/Flansche	57	18,5	PN 6	-10 – +110	GG/CI	S/E	37	no/nein	43
GHNbasic 80-190F PN 10	979523317	Flanges/Flansche	57	18,5	PN 10	-10 – +110	GG/CI	S/E	37	no/nein	43
GHNbasic 80-120F PN 6	979522811	Flanges/Flansche	70	12	PN 6	-10 – +120	GG/CI	S/E	34,2	no/nein	43
GHNbasic 80-120F PN 10	979522813	Flanges/Flansche	70	12	PN 10	-10 – +120	GG/CI	S/E	34,4	no/nein	43
GHNbasic 80-70F PN 6	979522812	Flanges/Flansche	60	6	PN 6	-10 – +120	GG/CI	S/E	33,4	no/nein	43
GHNbasic 80-70F PN 10	979522814	Flanges/Flansche	60	6	PN 10	-10 – +120	GG/CI	S/E	32,8	no/nein	43
GHNbasic 100-190F PN 6	979523315	Flanges/Flansche	57	18,5	PN 6	-10 – +110	GG/CI	S/E	37	no/nein	43
GHNbasic 100-190F PN 10	979523318	Flanges/Flansche	57	18,5	PN 10	-10 – +110	GG/CI	S/E	37	no/nein	43
GHNbasic 100-120F PN 6	979522815	Flanges/Flansche	75	11,5	PN 6	-10 – +120	GG/CI	S/E	38,3	no/nein	43
GHNbasic 100-120F PN 10	979522816	Flanges/Flansche	75	11,5	PN 10	-10 – +120	GG/CI	S/E	37,5	no/nein	43
GHNDbasic 40-190F	979523308	Flanges/Flansche	27	18	PN 6 / 10	-10 – +110	GG/CI	D/Z	40,3	no/nein	43
GHNDbasic 40-120F	979522817	Flanges/Flansche	34	12	PN 6 / 10	-10 – +120	GG/CI	D/Z	30,7	no/nein	43
GHNDbasic 40-70F	979522818	Flanges/Flansche	22	6	PN 6 / 10	-10 – +120	GG/CI	D/Z	31,1	no/nein	43
GHNDbasic 40-40F	979522819	Flanges/Flansche	18	3,5	PN 6 / 10	-10 – +120	GG/CI	D/Z	30,5	no/nein	43
GHNDbasic 50-190F	979523309	Flanges/Flansche	37	19,5	PN 6 / 10	-10 – +110	GG/CI	D/Z	48,1	no/nein	43
GHNDbasic 50-120F	979522820	Flanges/Flansche	55	12	PN 6 / 10	-10 – +120	GG/CI	D/Z	44,1	no/nein	43

TEHNIICAL DATA / TECHNISCHE DATEN

pump type pumpentyp	code artikelnummer	connection type rohranschluss	max. flow durchfluss Q (m ³ /h)	max. Head Förder- höhe H (m)	system pressure systemdruck PN (bar)	min. - max. media temperature temp. des medius Tmin-Tmax (°C)	casing type werkstoffe GG / Cast iron	single-S double-D einzelne-E zwillings- bauform-Z	net weight Reinige- wicht (kg)	regulation geregelt yes /ja no /nein	degree of protection schutzart IP
GHNDbasic 50-70F	979522821	Flanges/Flansche	45	6	PN 6 / 10	-10 - +120	GG/CI	D/Z	43,8	no/nein	43
GHNDbasic 50-40F	979522822	Flanges/Flansche	38	3,5	PN 6 / 10	-10 - +120	GG/CI	D/Z	43,2	no/nein	43
GHNDbasic 65-190F	979523310	Flanges/Flansche	57	18,5	PN 6 / 10	-10 - +110	GG/CI	D/Z	55,5	no/nein	43
GHNDbasic 65-120F	979522823	Flanges/Flansche	85	12	PN 6 / 10	-10 - +120	GG/CI	D/Z	56,2	no/nein	43
GHNDbasic 65-70F	979522824	Flanges/Flansche	60	6	PN 6 / 10	-10 - +120	GG/CI	D/Z	55,8	no/nein	43
GHNDbasic 65-40F	979522825	Flanges/Flansche	55	3,5	PN 6 / 10	-10 - +120	GG/CI	D/Z	55,8	no/nein	43
GHNDbasic 80-190F PN 6	979523312	Flanges/Flansche	57	18,5	PN 6	-10 - +110	GG/CI	D/Z	58,5	no/nein	43
GHNDbasic 80-190F PN 10	979523316	Flanges/Flansche	57	18,5	PN 10	-10 - +110	GG/CI	D/Z	60,1	no/nein	43
GHNDbasic 80-120F PN 6	979522826	Flanges/Flansche	120	12	PN 6	-10 - +120	GG/CI	D/Z	59,4	no/nein	43
GHNDbasic 80-120F PN 10	979522828	Flanges/Flansche	120	12	PN 10	-10 - +120	GG/CI	D/Z	59,5	no/nein	43
GHNDbasic 80-70F PN 6	979522827	Flanges/Flansche	95	6	PN 6	-10 - +120	GG/CI	D/Z	57,9	no/nein	43
GHNDbasic 80-70F PN 10	979522829	Flanges/Flansche	95	6	PN 10	-10 - +120	GG/CI	D/Z	57,8	no/nein	43
GHNauto 40-120F	979522838	Flanges/Flansche	20	12	PN 6 / 10	-10 - +120	GG/CI	S/E	17,9	no/nein	43
GHNauto 40-70F	979522839	Flanges/Flansche	13	6	PN 6 / 10	-10 - +120	GG/CI	S/E	17,7	no/nein	43
GHNauto 40-40F	979522840	Flanges/Flansche	10	3,5	PN 6 / 10	-10 - +120	GG/CI	S/E	17,4	no/nein	43
GHNauto 50-120F	979522841	Flanges/Flansche	30	12	PN 6 / 10	-10 - +120	GG/CI	S/E	24,6	no/nein	43
GHNauto 50-70F	979522842	Flanges/Flansche	25	6	PN 6 / 10	-10 - +120	GG/CI	S/E	24,3	no/nein	43
GHNauto 50-40F	979522843	Flanges/Flansche	20	3,5	PN 6 / 10	-10 - +120	GG/CI	S/E	24	no/nein	43
GHNauto 65-120F	979522844	Flanges/Flansche	50	12	PN 6 / 10	-10 - +120	GG/CI	S/E	30,8	no/nein	43
GHNauto 65-70F	979522845	Flanges/Flansche	35	6	PN 6 / 10	-10 - +120	GG/CI	S/E	28,6	no/nein	43
GHNauto 65-40F	979522846	Flanges/Flansche	33	3,5	PN 6 / 10	-10 - +120	GG/CI	S/E	28,6	no/nein	43
GHNauto 80-120F PN 6	979522847	Flanges/Flansche	70	12	PN 6	-10 - +120	GG/CI	S/E	34,2	no/nein	43
GHNauto 80-120F PN 10	979522849	Flanges/Flansche	70	12	PN 10	-10 - +120	GG/CI	S/E	34,4	no/nein	43
GHNauto 80-70F PN 6	979522848	Flanges/Flansche	60	6	PN 6	-10 - +120	GG/CI	S/E	33,4	no/nein	43
GHNauto 80-70F PN 10	979522850	Flanges/Flansche	60	6	PN 10	-10 - +120	GG/CI	S/E	32,8	no/nein	43
GHNauto 100-120F PN 6	979522851	Flanges/Flansche	75	11,5	PN 6	-10 - +120	GG/CI	S/E	38,3	no/nein	43
GHNauto 100-120F PN 10	979522852	Flanges/Flansche	75	11,5	PN 10	-10 - +120	GG/CI	S/E	37,5	no/nein	43
GHNDauto 40-120F	979522853	Flanges/Flansche	34	12	PN 6 / 10	-10 - +120	GG/CI	D/Z	31,5	no/nein	43
GHNDauto 40-70F	979522854	Flanges/Flansche	22	6	PN 6 / 10	-10 - +120	GG/CI	D/Z	31,1	no/nein	43
GHNDauto 40-40F	979522855	Flanges/Flansche	18	3,5	PN 6 / 10	-10 - +120	GG/CI	D/Z	30,5	no/nein	43
GHNDauto 50-120F	979522856	Flanges/Flansche	55	12	PN 6 / 10	-10 - +120	GG/CI	D/Z	44,1	no/nein	43
GHNDauto 50-70F	979522857	Flanges/Flansche	45	6	PN 6 / 10	-10 - +120	GG/CI	D/Z	43,8	no/nein	43
GHNDauto 50-40F	979522858	Flanges/Flansche	38	3,5	PN 6 / 10	-10 - +120	GG/CI	D/Z	43,2	no/nein	43
GHNDauto 65-120F	979522859	Flanges/Flansche	85	12	PN 6 / 10	-10 - +120	GG/CI	D/Z	56,2	no/nein	43
GHNDauto 65-70F	979522860	Flanges/Flansche	60	6	PN 6 / 10	-10 - +120	GG/CI	D/Z	55,8	no/nein	43
GHNDauto 65-40F	979522861	Flanges/Flansche	55	3,5	PN 6 / 10	-10 - +120	GG/CI	D/Z	55,8	no/nein	43
GHNDauto 80-120F PN 6	979522862	Flanges/Flansche	120	12	PN 6	-10 - +120	GG/CI	D/Z	59,4	no/nein	43
GHNDauto 80-120F PN 10	979522864	Flanges/Flansche	120	12	PN 10	-10 - +120	GG/CI	D/Z	59,5	no/nein	43
GHNDauto 80-70F PN 6	979522863	Flanges/Flansche	95	6	PN 6	-10 - +120	GG/CI	D/Z	57,9	no/nein	43
GHNDauto 80-70F PN 10	979522865	Flanges/Flansche	95	6	PN 10	-10 - +120	GG/CI	D/Z	57,8	no/nein	43
GHNM 40/75F 220	979522753	Flanges/Flansche	12	7,1	PN 10	-10 - +110	GG/CI	S/E	9	no/nein	44
GHNM 40/80F 220	979522754	Flanges/Flansche	10,25	7,4	PN 10	-10 - +110	GG/CI	S/E	8,5	no/nein	44
GHNMbasic 40-190F	979523263	Flanges/Flansche	24	14	PN 6 / 10	-10 - +110	GG/CI	S/E	22,5	no/nein	43
GHNMbasic 40 - 120F	979522830	Flanges/Flansche	19,2	10	PN 6 / 10	-10 - +110	GG/CI	S/E	19	no/nein	43
GHNMbasic 40 - 70F	979522831	Flanges/Flansche	16,1	6,1	PN 6 / 10	-10 - +110	GG/CI	S/E	19	no/nein	43
GHNMbasic 50 - 120F	979522832	Flanges/Flansche	29,5	11	PN 6 / 10	-10 - +110	GG/CI	S/E	24	no/nein	43
GHNMbasic 50 - 70F	979522833	Flanges/Flansche	24,5	5,4	PN 6 / 10	-10 - +110	GG/CI	S/E	24	no/nein	43
GHNMDbasic 40-190F	979523313	Flanges/Flansche	24	14	PN 6 / 10	-10 - +110	GG/CI	D/Z	37	no/nein	43
GHNMDbasic 40 - 120F	979522834	Flanges/Flansche	19,2	10	PN 6 / 10	-10 - +110	GG/CI	D/Z	39	no/nein	43
GHNMDbasic 40 - 70F	979522835	Flanges/Flansche	16,1	6,1	PN 6 / 10	-10 - +110	GG/CI	D/Z	39	no/nein	43
GHNMDbasic 50 - 120F	979522836	Flanges/Flansche	29,5	11	PN 6 / 10	-10 - +110	GG/CI	D/Z	49	no/nein	43
GHNMDbasic 50 - 70F	979522837	Flanges/Flansche	24,5	5,4	PN 6 / 10	-10 - +110	GG/CI	D/Z	49	no/nein	43

DIMENSIONS / MAßE

	pump type pumpentyp	code artikelnummer	length einbaulänge L (mm)	connection size rohranschluss DN	a	l	b1	b2	R	b	h1
1	GHN 15/40-130	979521960	130	DN 15	28	108	80	44			
	GHN 15/60-130	979521961	130	DN 15	28	108	80	44			
	GHN 15/65-130	979521962	130	DN 15	28	108	80	44			
	GHN 20/40-130	979521700	130	DN 20	28	108	80	44			
	GHN 25/40-130	979521701	130	DN 25	28	108	80	44			
	GHN 20/60-130	979521702	130	DN 20	28	108	80	44			
	GHN 25/60-130	979521703	130	DN 25	28	108	80	44			
	GHN 20/65-130	979521706	130	DN 20	28	108	80	44			
	GHN 25/65-130	979521707	130	DN 25	28	108	80	44			
	GHN 20/40-180	979521709	180	DN 20	28	108	80	44			
	GHN 25/40-180	979521710	180	DN 25	28	108	80	44			
	GHN 32/40-180	979521711	180	DN 32	30	108	80	44			
	GHN 20/60-180	979521712	180	DN 20	28	108	80	44			
	GHN 25/60-180	979521713	180	DN 25	28	108	80	44			
	GHN 32/60-180	979521714	180	DN 32	30	108	80	44			
	GHN 25/65-180	979521704	180	DN 25	28	108	80	44			
	GHN 32/65-180	979521705	180	DN 32	30	108	80	44			
	GHN 25/70-180	979521987	180	DN 25	30	108	80	44			
	GHN 32/70-180	979521983	180	DN 32	30	108	80	44			
	GHN 25/80-180	979523116	180	DN 25	28	150	80	57			
GHN 32/80-180	979521944	180	DN 32	31	150	80	57				
GHN 32/85-180	979522752	180	DN 32	65	174	80	75				
GHN 32/120-180	979522005	180	DN 32	31	173	80	67				
2	GHND 32/70-180	979522021	180	DN 32	29	212	85			240	78
	GHND 32/80-180	979522022	180	DN 32	40	142	85			255	77,5
	GHND 32/120-180	979522023	180	DN 32	34	168	85			280	79
4	GHNbasic 40-190F	979523262	250	DN 40	65	240	130	92	1/4"		
	GHNbasic (auto) 40-120F	979522802	250	DN 40	65	198	125	92	1/4"		
	GHNbasic (auto) 40-70F	979522803	250	DN 40	65	198	125	92	1/4"		
	GHNbasic (auto) 40-40F	979522804	250	DN 40	65	198	125	92	1/4"		
	GHNbasic 50-190F	979523264	280	DN 50	70	250	130	113	1/4"		
	GHNbasic (auto) 50-120F	979522805	280	DN 50	70	250	130	113	1/4"		
	GHNbasic (auto) 50-70F	979522806	280	DN 50	70	250	130	113	1/4"		
	GHNbasic (auto) 50-40F	979522807	280	DN 50	70	250	130	113	1/4"		
	GHNbasic 65-190F	979523265	340	DN 65	80	252	130	123	1/4"		
	GHNbasic (auto) 65-120F	979522808	340	DN 65	80	252	130	123	1/4"		
	GHNbasic (auto) 65-70F	979522809	340	DN 65	80	252	130	123	1/4"		
	GHNbasic (auto) 65-40F	979522810	340	DN 65	80	252	130	123	1/4"		
	GHNbasic 80-190F PN6	979523314	360	DN 80	100	257	130	130	1/4"		
	GHNbasic 80-190F PN10	979523317	360	DN 80	100	257	130	130	1/4"		
	GHNbasic (auto) 80-120F PN6	979522811	360	DN 80	100	257	130	129,5	1/4"		
	GHNbasic (auto) 80-120F PN10	979522813	360	DN 80	100	257	130	129,5	1/4"		
	GHNbasic (auto) 80-70F PN6	979522812	360	DN 80	100	257	130	129,5	1/4"		
	GHNbasic (auto) 80-70F PN10	979522814	360	DN 80	100	257	130	129,5	1/4"		
	GHNbasic 100-190F PN6	979523315	360	DN 100	110	257	130	130	1/4"		
	GHNbasic 100-190F PN10	979523318	360	DN 100	110	257	130	130	1/4"		
GHNbasic (auto) 100-120F PN6	979522815	360	DN 100	110	257	130	130	1/4"			
GHNbasic (auto) 100-120F PN10	979522816	360	DN 100	110	257	130	130	1/4"			
5	GHNDbasic 40-190F	979523308	250	DN 40	62	240	130		1/4"	346	110
	GHNDbasic (auto) 40-120F	979522817	250	DN 40	62	198	125		1/4"	346	110
	GHNDbasic (auto) 40-70F	979522818	250	DN 40	62	198	125		1/4"	346	110
	GHNDbasic (auto) 40-40F	979522819	250	DN 40	62	198	125		1/4"	346	110
	GHNDbasic 50-190F	979523309	280	DN 50	70	250	130		1/4"	400	121
	GHNDbasic (auto) 50-120F	979522820	280	DN 50	70	250	130		1/4"	400	121

DIMENSIONS / MAßE

	pump type pumpentyp	code artikelnummer	length einbaulänge L (mm)	connection size rohranschluss DN	a	l	b1	b2	R	b	h1
4	GHNDbasic (auto) 50-70F	979522821	280	DN 50	70	250	130		1/4"	400	121
	GHNDbasic (auto) 50-40F	979522822	280	DN 50	70	250	130		1/4"	400	121
	GHNDbasic 65-190F	979522310	340	DN 65	80	252	130		1/4"	450	141
	GHNDbasic (auto) 65-120F	979522823	340	DN 65	80	252	130		1/4"	450	141
	GHNDbasic (auto) 65-70F	979522824	340	DN 65	80	252	130		1/4"	450	141
	GHNDbasic (auto) 65-40F	979522825	340	DN 65	80	252	130		1/4"	450	141
	GHNDbasic 80-190F PN6	979522312	360	DN 80	95	257	130		1/4"	470	146
	GHNDbasic 80-190F PN10	979522316	360	DN 80	95	257	130		1/4"	470	146
	GHNDbasic (auto) 80-120F PN6	979522826	360	DN 80	95	257	130		1/4"	470	146
	GHNDbasic (auto) 80-120F PN10	979522828	360	DN 80	95	257	130		1/4"	470	146
	GHNDbasic (auto) 80-70F PN6	979522827	360	DN 80	95	257	130		1/4"	470	146
	GHNDbasic (auto) 80-70F PN10	979522829	360	DN 80	95	257	130		1/4"	470	146
3	GHNM 40/75F 220	979522753	220	DN 40	65	174	80	75			
	GHNM 40/80F 220	979522754	220	DN 40	65	145	80	75			
4	GHNMbasic 40-190F	979523263	250	DN 40	65	240	130	92	1/4"		
	GHNMbasic 40 - 120F	979522830	250	DN 40	65	198	130	92	1/4"	346	
	GHNMbasic 40 - 70F	979522831	250	DN 40	65	198	130	92	1/4"	346	
	GHNMbasic 50 - 120F	979522832	280	DN 50	70	250	130	113	1/4"	400	
	GHNMbasic 50 - 70F	979522833	280	DN 50	70	250	130	113	1/4"	400	
5	GHNMDbasic 40-190F	979523313	250	DN 40	62	240	130		1/4"	346	110
	GHNMDbasic 40 - 120F	979522834	250	DN 40	62	198	130		1/4"	346	110
	GHNMDbasic 40 - 70F	979522835	250	DN 40	62	198	130		1/4"	346	110
	GHNMDbasic 50 - 120F	979522836	280	DN 50	70	250	130		1/4"	400	121
	GHNMDbasic 50 - 70F	979522837	280	DN 50	70	250	130		1/4"	400	121

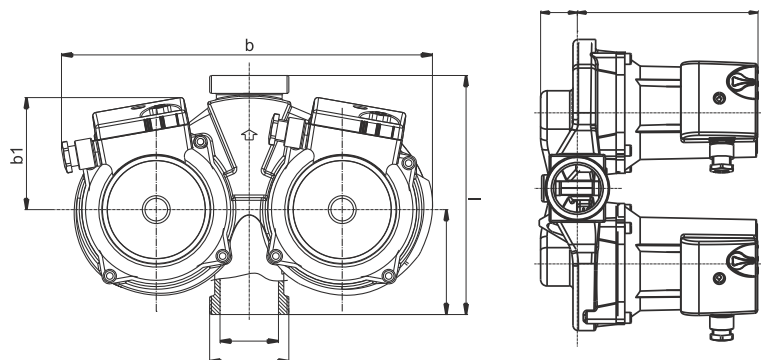
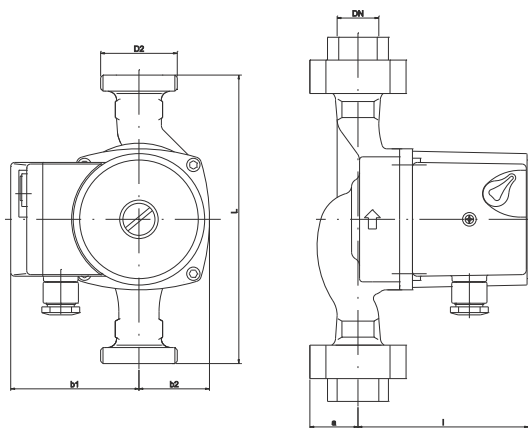

3

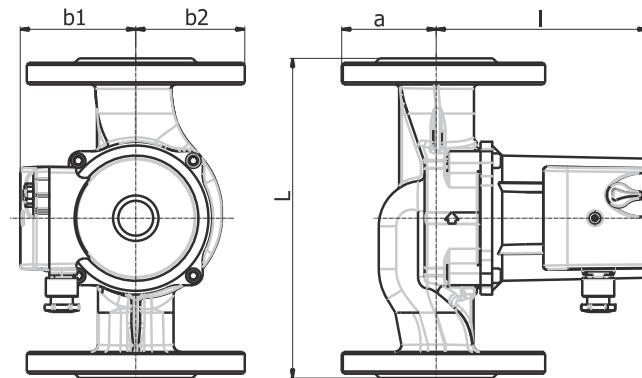



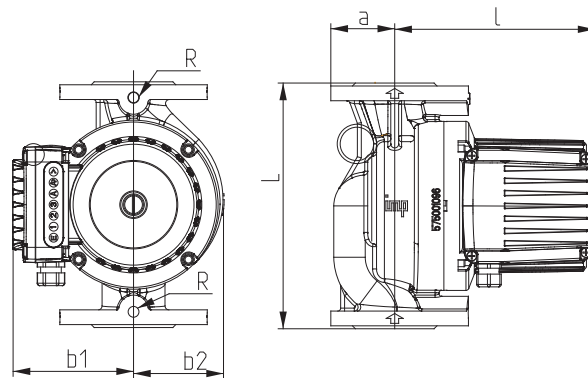

4

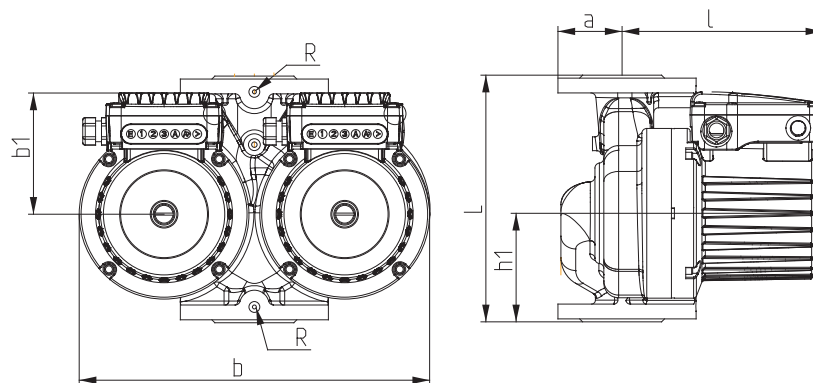

5



ELECTRICAL DATA / ELEKTRISCHE DATEN							MIN WORKING PRESSURE (bar) MIN ZÜLASSIGER BETRIEBSDRUCK		
pump type pumpentyp	code artikelnummer	power max. leistung aufnahme P (kW)	speed range drehzahlstufe (min-1)	FLC I nennstrom In (A)	electrical voltage elektroanschluss U (V)	insulating class isoliationsklasse	temperature / temperatur		
							50°C	80°C	110°C
GHN 15/40-130	979521960	50	1315 - 2456	0,15 - 0,21	1 ~ 230 V	H	0,05	0,4	1,1
GHN 15/60-130	979521961	90	1080 - 1980	0,15 - 0,39	1 ~ 230 V	H	0,05	0,4	1,1
GHN 15/65-130	979521962	95	1080 - 1980	0,19 - 0,44	1 ~ 230 V	H	0,05	0,4	1,1
GHN 20/40-130	979521700	50	1315 - 2456	0,15 - 0,21	1 ~ 230 V	H	0,05	0,4	1,1
GHN 25/40-130	979521701	50	1315 - 2456	0,15 - 0,21	1 ~ 230 V	H	0,05	0,4	1,1
GHN 20/60-130	979521702	90	1080 - 1980	0,17 - 0,39	1 ~ 230 V	H	0,05	0,4	1,1
GHN 25/60-130	979521703	90	1080 - 1980	0,17 - 0,39	1 ~ 230 V	H	0,05	0,4	1,1
GHN 20/65-130	979521706	95	1080 - 1980	0,19 - 0,41	1 ~ 230 V	H	0,05	0,4	1,1
GHN 25/65-130	979521707	95	1080 - 1980	0,19 - 0,41	1 ~ 230 V	H	0,05	0,4	1,1
GHN 20/40-180	979521709	50	1315 - 2456	0,15 - 0,21	1 ~ 230 V	H	0,05	0,4	1,1
GHN 25/40-180	979521710	50	1315 - 2456	0,15 - 0,21	1 ~ 230 V	H	0,05	0,4	1,1
GHN 32/40-180	979521711	50	1315 - 2456	0,15 - 0,21	1 ~ 230 V	H	0,05	0,4	1,1
GHN 20/60-180	979521712	90	1080 - 1980	0,17 - 0,39	1 ~ 230 V	H	0,05	0,4	1,1
GHN 25/60-180	979521713	90	1080 - 1980	0,17 - 0,39	1 ~ 230 V	H	0,05	0,4	1,1
GHN 32/60-180	979521714	90	1080 - 1980	0,17 - 0,39	1 ~ 230 V	H	0,05	0,4	1,1
GHN 25/65-180	979521704	95	1080 - 1980	0,19 - 0,41	1 ~ 230 V	H	0,05	0,4	1,1
GHN 32/65-180	979521705	95	1080 - 1980	0,19 - 0,41	1 ~ 230 V	H	0,05	0,4	1,1
GHN 25/70-180	979521987	140	1109 - 2340	0,39 - 0,62	1 ~ 230 V	H	0,05	0,4	1,1
GHN 32/70-180	979521983	140	1109 - 2340	0,39 - 0,62	1 ~ 230 V	H	0,05	0,4	1,1
GHN 25/80-180	979523116	204	1150 - 2450	0,58 - 0,88	1 ~ 230 V	200	0,05	0,4	1,2
GHN 32/80-180	979521944	210	1150 - 2450	0,46 - 0,91	1 ~ 230 V	200	0,05	0,4	1,2
GHN 32/85-180	979522752	277	1150 - 2450	0,85 - 1,20	1 ~ 230 V	200	0,05	0,4	1,2
GHN 32/120-180	979522005	265	1150 - 2450	0,75 - 1,15	1 ~ 230 V	200	0,05	0,4	1,2
GHND 32/70-180	979522021	140	1109 - 2340	0,39 - 0,62	1 ~ 230 V	200	0,05	0,4	1,2
GHND 32/80-180	979522022	210	1150 - 2450	0,49 - 0,95	1 ~ 230 V	200	0,05	0,4	1,2
GHND 32/120-180	979522023	265	1150 - 2450	0,85 - 1,15	1 ~ 230 V	200	0,05	0,4	1,2
GHNbasic 40-190F	979523262	1260		2,24	3 ~ 400 V	200	0,05	0,8	1,4
GHNbasic (auto) 40-120F	979522802	578	1250 - 2820	0,36 - 1,46	3 ~ 400 V	200	0,05	0,8	1,4
GHNbasic (auto) 40-70F	979522803	295	1440 - 2790	0,18 - 0,74	3 ~ 400 V	200	0,05	0,8	1,4
GHNbasic (auto) 40-40F	979522804	200	660 - 1440	0,11 - 0,76	3 ~ 400 V	200	0,05	0,8	1,4
GHNbasic 50-190F	979523264	1596		2,90	3 ~ 400 V	200	0,3	1	1,6
GHNbasic (auto) 50-120F	979522805	1020	1270 - 2800	0,46 - 1,73	3 ~ 400 V	200	0,3	1	1,6
GHNbasic (auto) 50-70F	979522806	470	560 - 1400	0,2 - 1,15	3 ~ 400 V	200	0,3	1	1,6
GHNbasic (auto) 50-40F	979522807	340	620 - 1450	0,22 - 1,05	3 ~ 400 V	200	0,3	1	1,6
GHNbasic 65-190F	979523265	2346		4,00	3 ~ 400 V	200	0,3	1	1,6
GHNbasic (auto) 65-120F	979522808	1560	1250 - 2810	0,84 - 2,8	3 ~ 400 V	200	0,3	1	1,6
GHNbasic (auto) 65-70F	979522809	578	450 - 1370	0,27 - 1,5	3 ~ 400 V	200	0,3	1	1,6
GHNbasic (auto) 65-40F	979522810	400	600 - 1430	0,22 - 1,1	3 ~ 400 V	200	0,3	1	1,6
GHNbasic 80-190F PN 6	979523314	2272		3,90	3 ~ 400 V	200	0,3	1	1,6
GHNbasic 80-190F PN10	979523317	2272		3,90	3 ~ 400 V	200	0,3	1	1,6
GHNbasic (auto) 80-120F PN6	979522811	2200	1200 - 2800	1,05 - 3,8	3 ~ 400 V	200	0,3	1	1,6
GHNbasic (auto) 80-120F PN10	979522813	2200	1200 - 2800	1,05 - 3,8	3 ~ 400 V	200	0,3	1	1,6
GHNbasic (auto) 80-70F PN 6	979522812	960	600 - 1350	0,38 - 2,2	3 ~ 400 V	200	0,3	1	1,6
GHNbasic (auto) 80-70F PN10	979522814	960	600 - 1350	0,38 - 2,2	3 ~ 400 V	200	0,3	1	1,6
GHNbasic 100-190F PN 6	979523315	2287		3,90	3 ~ 400 V	200	0,3	1	1,6
GHNbasic 100-190F PN10	979523318	2287		3,90	3 ~ 400 V	200	0,3	1	1,6
GHNbasic (auto) 100-120F PN 6	979522815	2324	1200 - 2800	1,16 - 4,0	3 ~ 400 V	200	0,3	1	1,6
GHNbasic (auto) 100-120F PN10	979522816	2324	1200 - 2800	1,16 - 4,0	3 ~ 400 V	200	0,3	1	1,6
GHNDbasic 40-190F	979523308	1260		2,24	3 ~ 400 V	200	0,05	0,8	1,4
GHNDbasic (auto) 40-120F	979522817	578	1250 - 2820	0,35 - 1,46	3 ~ 400 V	200	0,05	0,8	1,4
GHNDbasic (auto) 40-70F	979522818	295	1440 - 2790	0,18 - 0,74	3 ~ 400 V	200	0,05	0,8	1,4
GHNDbasic (auto) 40-40F	979522819	200	660 - 1440	0,11 - 0,76	3 ~ 400 V	200	0,05	0,8	1,4
GHNDbasic 50-190F	979523309	1596		2,90	3 ~ 400 V	200	0,3	1	1,6
GHNDbasic (auto) 50-120F	979522820	1020	1270 - 2800	0,46 - 1,73	3 ~ 400 V	200	0,3	1	1,6

ELECTRICAL DATA / ELEKTRISCHE DATEN							MIN WORKING PRESSURE (bar) MIN ZÜLASSIGER BETRIEBSDRUCK		
pump type pumpentyp	code artikelnummer	power max. leistung- saufnahme P (W)	speed range drehzahlstufe (min-1)	FLC I nennstrom In (A)	electrical voltage elektroanschluss U (V)	insulating class isolationsklasse	temperature / temperatur		
							50°C	80°C	110°C
 GHNDbasic (auto) 50-70F	979522821	470	560 - 1400	0,2 - 1,15	3 ~ 400 V	200	0,3	1	1,6
GHNDbasic (auto) 50-40F	979522822	340	620 - 1450	0,22 - 1,05	3 ~ 400 V	200	0,3	1	1,6
GHNDbasic 65-190F	979522310	2346		4,00	3 ~ 400 V	200	0,3	1	1,6
GHNDbasic (auto) 65-120F	979522823	1560	1250 - 2810	0,84 - 2,8	3 ~ 400 V	200	0,3	1	1,6
GHNDbasic (auto) 65-70F	979522824	578	450 - 1370	0,27 - 1,5	3 ~ 400 V	200	0,3	1	1,6
GHNDbasic (auto) 65-40F	979522825	400	600 - 1430	0,22 - 1,1	3 ~ 400 V	200	0,3	1	1,6
GHNDbasic 80-190F PN 6	979522312	2272		3,90	3 ~ 400 V	200	0,3	1	1,6
GHNDbasic 80-190F PN 10	979522316	2272		3,90	3 ~ 400 V	200	0,3	1	1,6
GHNDbasic (auto) 80-120F PN 6	979522826	2200	1200 - 2800	1,05 - 3,8	3 ~ 400 V	200	0,3	1	1,6
GHNDbasic (auto) 80-120F PN 10	979522828	960	600 - 1350	0,38 - 2,2	3 ~ 400 V	200	0,3	1	1,6
GHNDbasic (auto) 80-70F PN 6	979522827	2200	1200 - 2800	1,05 - 3,8	3 ~ 400 V	200	0,3	1	1,6
GHNDbasic (auto) 80-70F PN 10	979522829	960	600 - 1350	0,38 - 2,2	3 ~ 400 V	200	0,3	1	1,6
 GHNM 40/75F 220	979522753	277	1150 - 2450	0,85 - 1,2	1 ~ 230 V	200	0,05	0,4	1,2
 GHNM 40/80F 220	979522754	210	1150 - 2450	0,49 - 0,95	1 ~ 230 V	200	0,05	0,4	1,2
GHNMbasic 40-190F	979523263	928		4,00	1 ~ 230 V	200	0,05	0,8	1,4
GHNMbasic 40 - 120F	979522830	444		1,96	1 ~ 230 V	200	0,05	0,8	1,4
GHNMbasic 40 - 70F	979522831	272		1,21	1 ~ 230 V	200	0,05	0,8	1,4
GHNMbasic 50 - 120F	979522832	827		3,60	1 ~ 230 V	200	0,3	1	1,6
 GHNMbasic 50 - 70F	979522833	423		1,90	1 ~ 230 V	200	0,3	1	1,6
GHNMDbasic 40-190F	979523313	928		4,00	1 ~ 230 V	200	0,05	0,8	1,4
GHNMDbasic 40 - 120F	979522834	444		1,96	1 ~ 230 V	200	0,05	0,8	1,4
GHNMDbasic 40 - 70F	979522835	272		1,21	1 ~ 230 V	200	0,05	0,8	1,4
GHNMDbasic 50 - 120F	979522836	827		3,60	1 ~ 230 V	200	0,3	1	1,6
GHNMDbasic 50 - 70F	979522837	423		1,90	1 ~ 230 V	200	0,3	1	1,6



**Pump type GHN, GHND,
 GHNMF**
Pumpentyp GHN, GHND, GHNMF

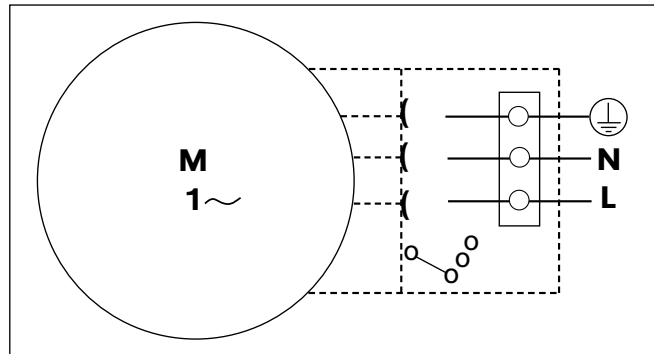

**Pump type GHNbasic (auto) F and GHNDbasic (auto) F are three-phase (3 ~ 400
 V / 50 Hz)**
**Pumpentyp GHNbasic (auto) F und GHNDbasic (auto) F sind dreiphasige
 Ausführungen (3 ~ 400 V / 50 Hz)**

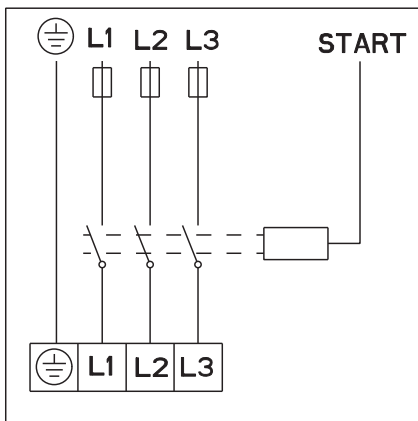

**Connection and description of electric
 connectors:**

THREE PHASE CONNECTION

connection L3:

Phase L3 (T) power source 3~400 V/50 Hz

connection L2:

Phase L2 (S) power source 3~400 V/50 Hz

connection L1:

Phase L1 (R) power source 3~400 V/50 Hz

connection ⊕:

Connect to the earth ground wire.

Elektrischer Anschluss:

DREIPHASIGER ANSCHLUSS

Anschluss L 3:

Phase L3 (T) Stromquelle 3~400 V/50 Hz

Anschluss L2:

Phase L2 (S) Stromquelle 3~400 V/50 Hz

Anschluss L1:

Phase L1 (R) Stromquelle 3~400 V/50 Hz

Anschluss ⊕:

Erdung



Pump type GHNMBasic F and GHNMDbasic F are single - phase (1 ~ 230 V / 50 Hz)
**Die Pumpentypen GHNMBasic F und GHNMDbasic F sind einphasige
 Ausführungen (1 ~ 230 V / 50 Hz)**

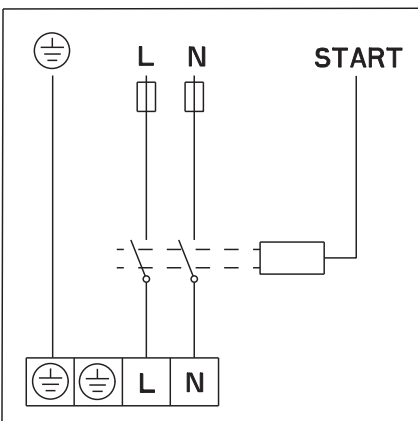

**Connection and description of electric
 connectors:**

SINGLE - PHASE CONNECTION

connection N:

Neutral N power source 1~230 V/50 Hz

connection L:

Phase L power source 1~230 V/50 Hz

connection ⊕:

Connect to the earth ground wire.

Elektrischer Anschluss:

MONOPHASIGER ANSCHLUSS

Anschluss N:

Neutral N Stromquelle 1~230 V/50 Hz

Anschluss L:

Phase L Stromquelle 1~230 V/50 Hz

Anschluss ⊕:

Erdung

SAN / SANbasic F

SAN / SANbasic F



Three speeds circulating pumps for sanitary
water
Dreistufige Zirkulationspumpen für
Brauchwasser



Three speeds circulating pumps for sanitary water Dreistufige Zirkulationspumpen für Brauchwasser

TEHNIICAL FEATURES / TECHNISCHE MERKMALE		SAN ECO	SAN	SANbasic F
Connections / Nenweite	DN (")	15	15, 20, 25, 32	40 - 65
Connection type / Rohranschluss		Screw Type/Gewind	Screw Type/Gewind	Flanges / Flansche
Flow max / Förderstrom max	Q (m³/h)	0,9	4/6/8	80
Pressure max / Förderhöhe	H (m)	1,1	4/6/7	12
Pressure rated / Betriebsdruck	PN (bar)	10	10	6 / 10
Power max / Leistungsaufnahme max	P (W)	2-8	50/90/148	2200
Electrical voltage / Elektroanschluss	V	1 ~ 230 V	1 ~ 230 V	3 ~ 400 V
Degree of protection / Schutzart	IP	44	44	43
Regulation / Regelung		yes / ja	no / nein	no / nein
Media temperature / Temperaturbereich	T(°C)	+5 to/bis +70	+5 to/bis +65	-10 to/bis +65
Insulating class / Isolationsklasse		F	H	H
Casing type / Werkstoffe		bronz / bronze	bronz / bronze	bronz / bronze
Duble pump / Zwilingspumpe		no / nein	no / nein	no / nein
APPLICATIONS / EINSATZGEBIETE				
Heating / Warmwasserheizungen		✓	✓	✓
Cooling / Kaltwasseranlagen		✓	✓	✓
Sanitary water / Brauchwasser		✓	✓	✓
Climate appliances / Klimaanlage		✓	✓	✓
Industry / Industrieanlagen				
Process technique / Verfahrenstechnik				
Condensation / Kondensat				
Salt water / Meerwasser				

Pump markings / Typenschlüssel

SAN 25 / 60 - 130 (180)

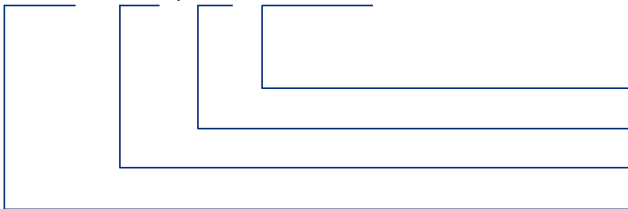

instalation lenght / einbaulänge
max head / förderhöhe
connection size / nennweite **DN**
circulating pump / Umwälzpumpe

SANbasic 40 - 120 F

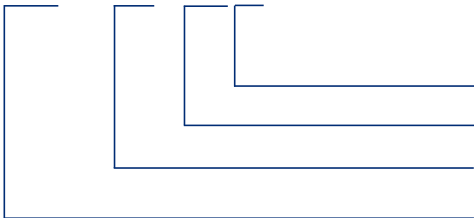

connection type - **Flange** / Rohranschluss - Flansche
max head / förderhöhe
connection size **DN** / nennweite **DN**
pump type / pumpentyp

Permitted mounting positions / Einbaumöglichkeiten



Threaded three speeds circulation pumps for sanitary water Dreistufige Verschraubungsumwälzpumpen mit manueller Drehzahlumschaltung

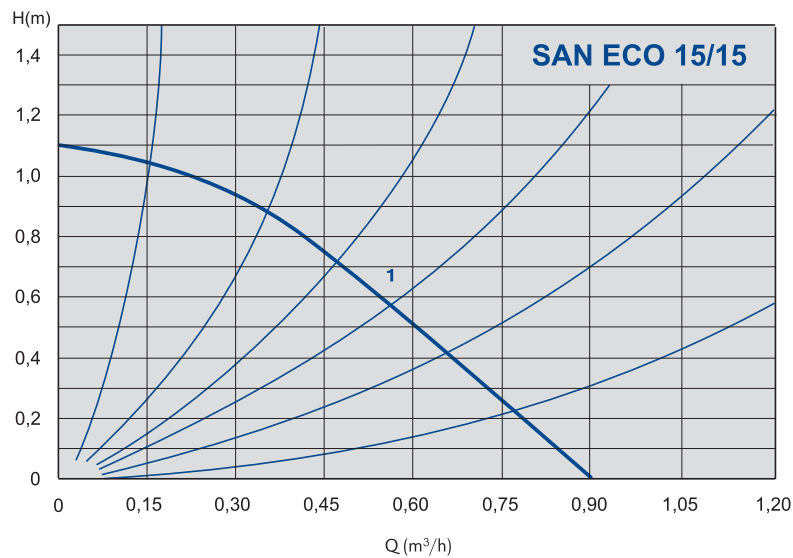
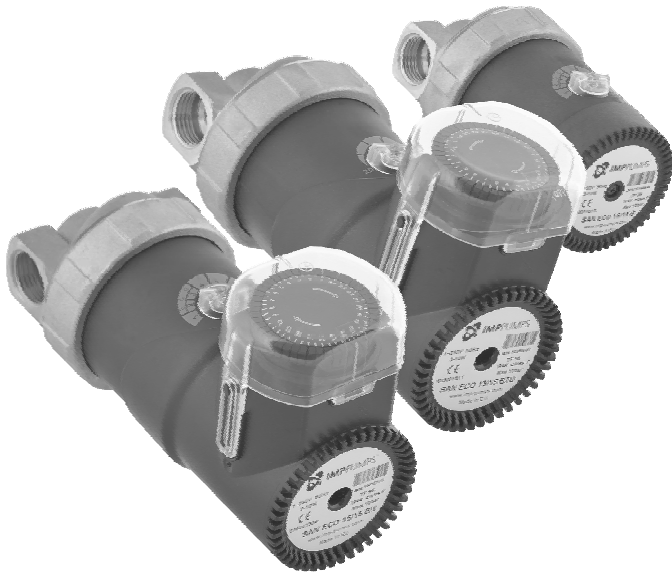

Threaded circulation pumps with three speeds for sanitary water
Dreistufige Verschraubungsumwälzpumpen mit manueller
Drehzahlumschaltung

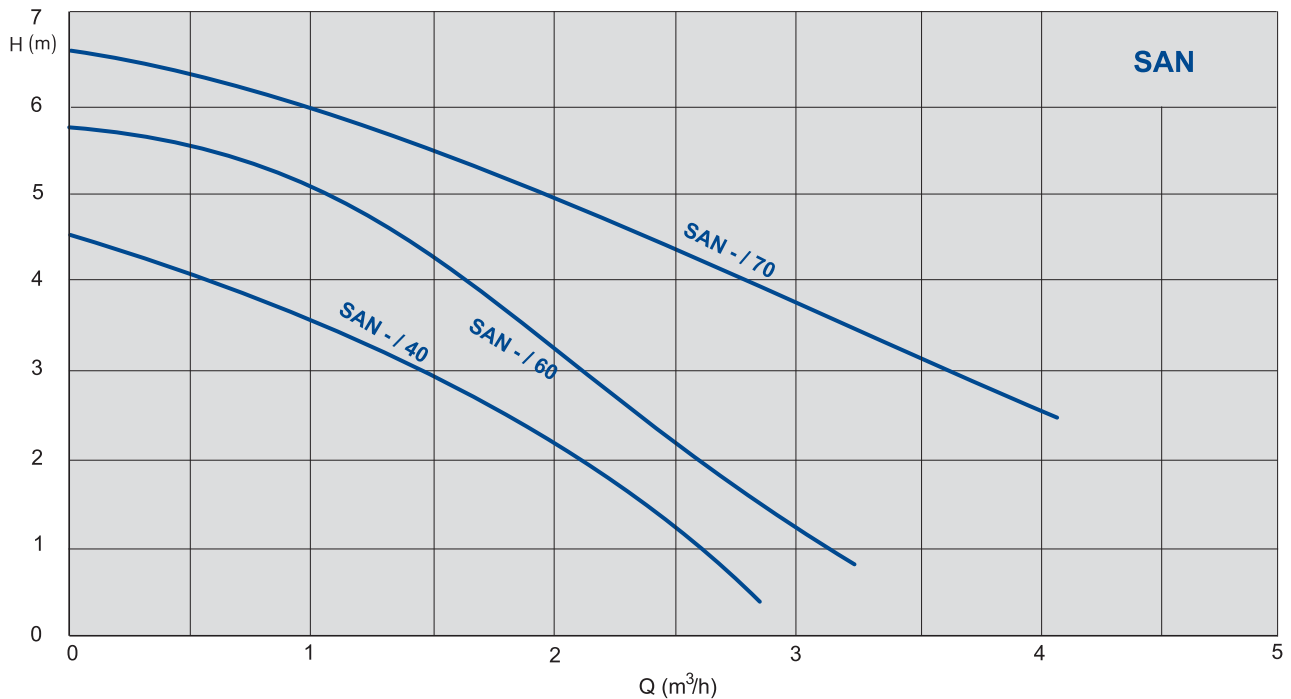
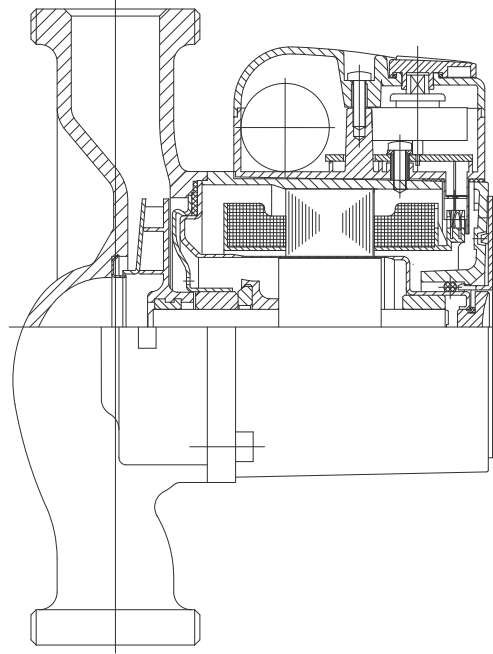

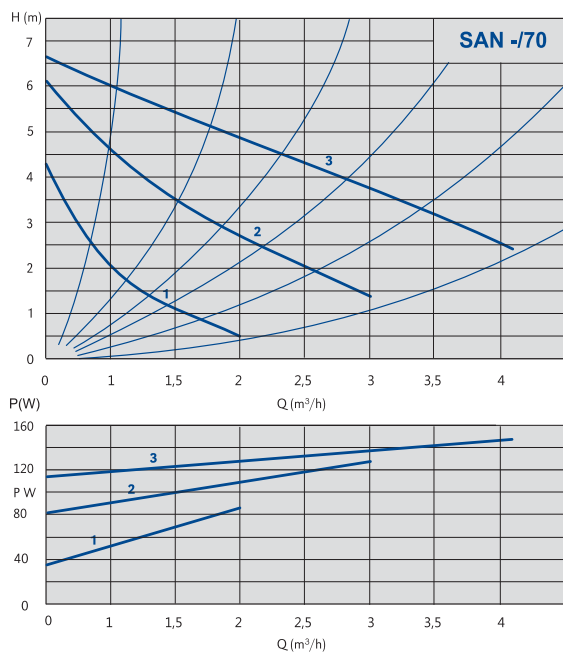
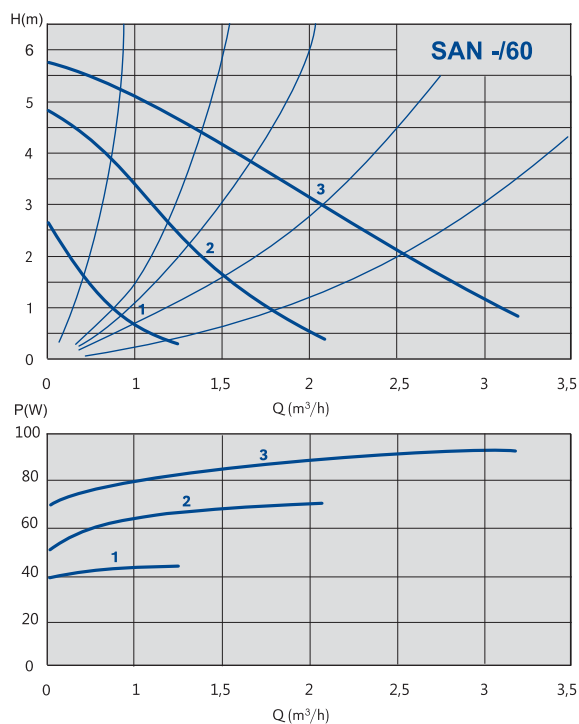
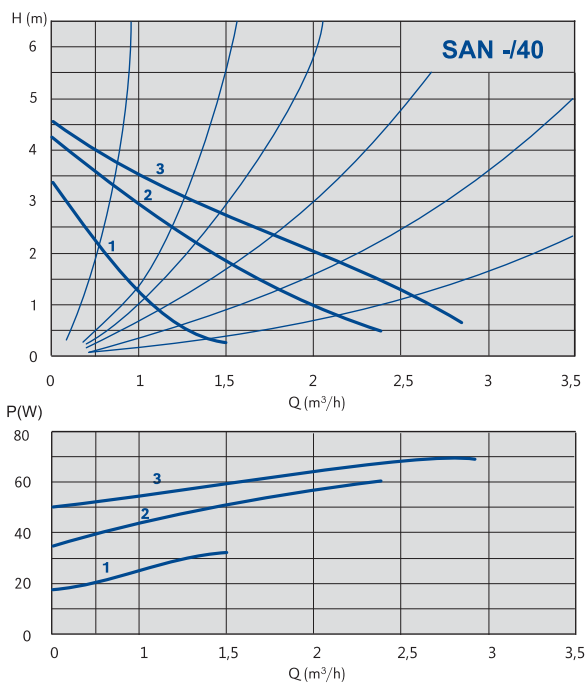

Three speeds circulation pumps for sanitary water with flanges
 Dreistufige Flanschumwälzpumpen mit manueller
 Drehzahlumschaltung für Brauchwasser

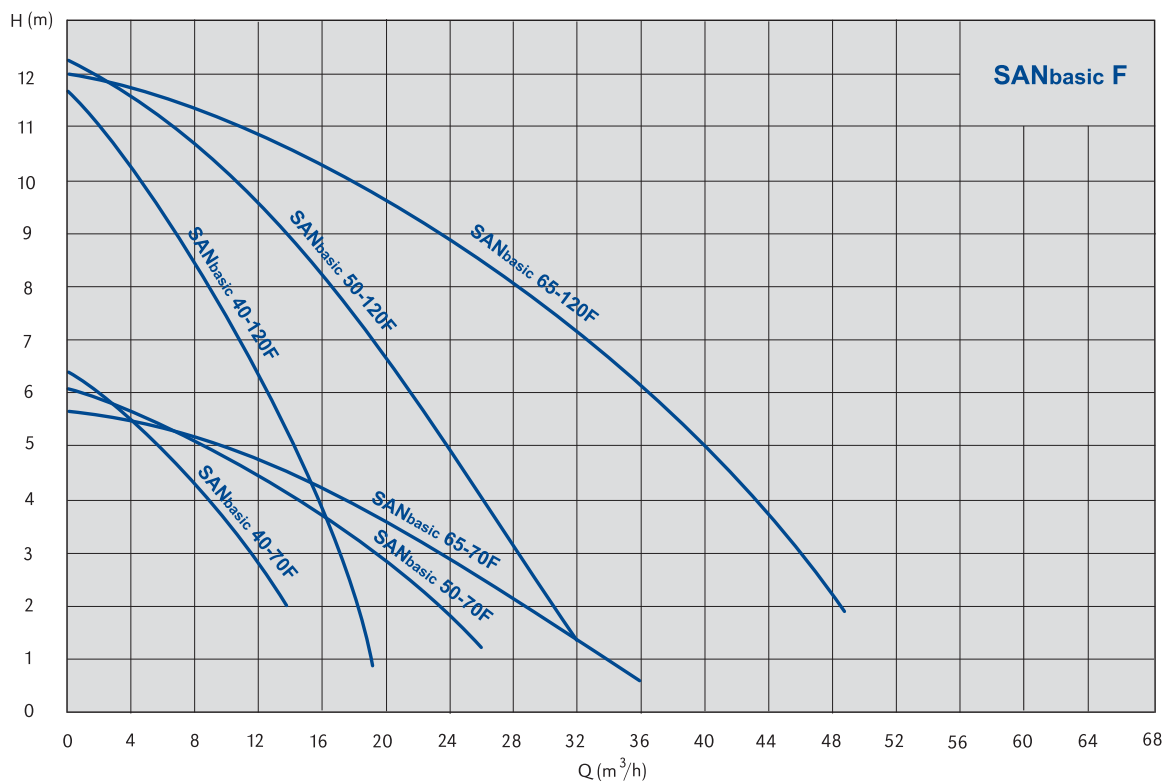
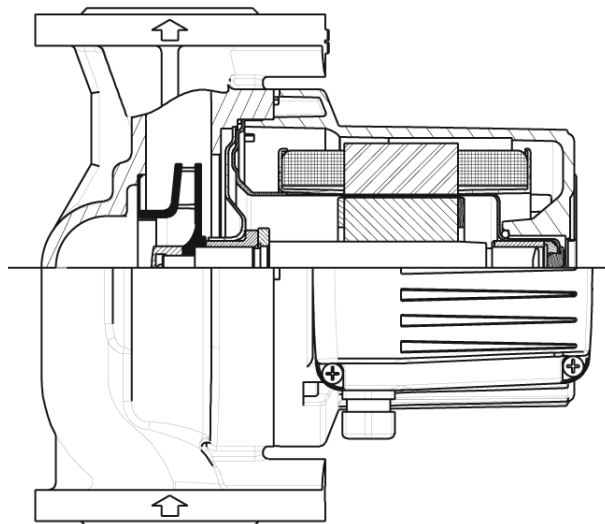

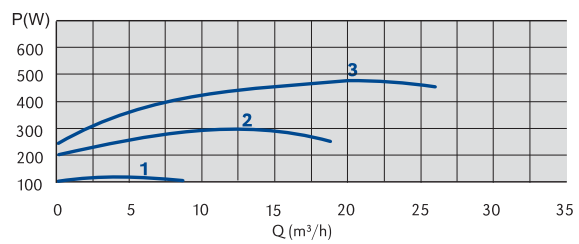
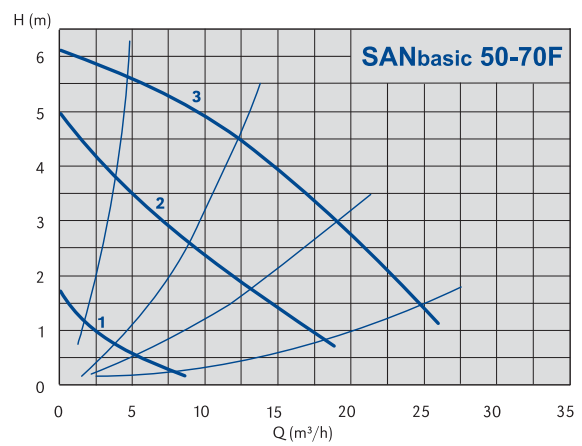
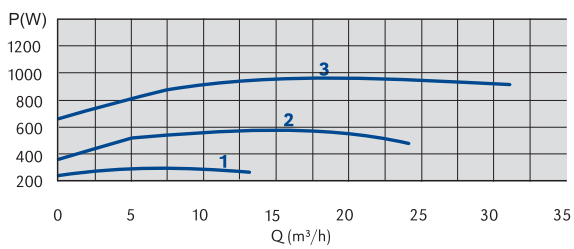
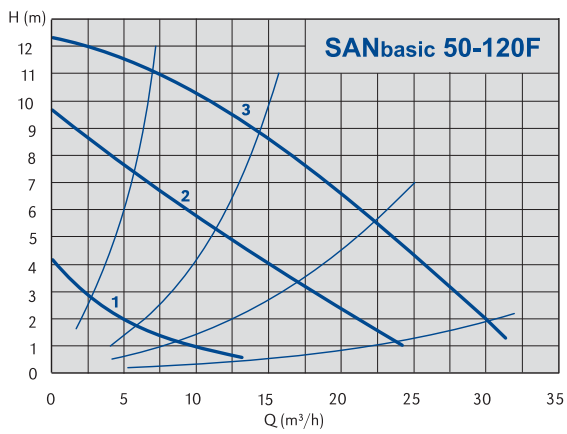
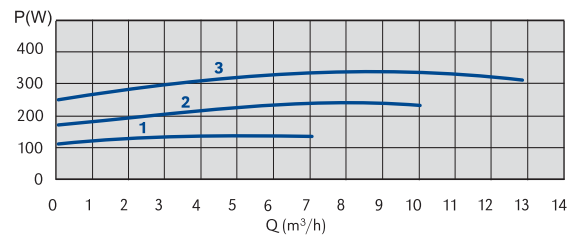
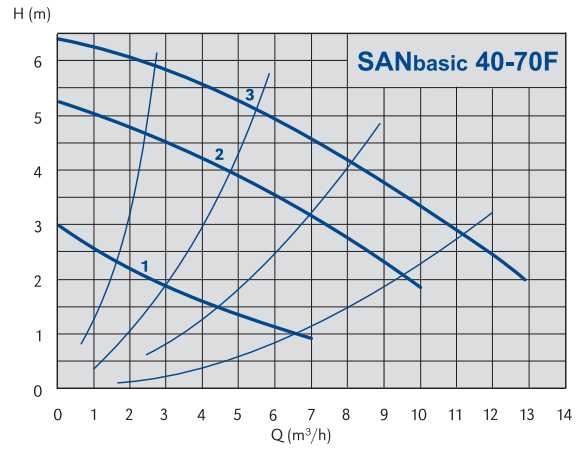
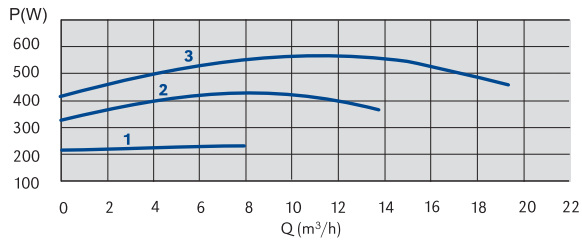
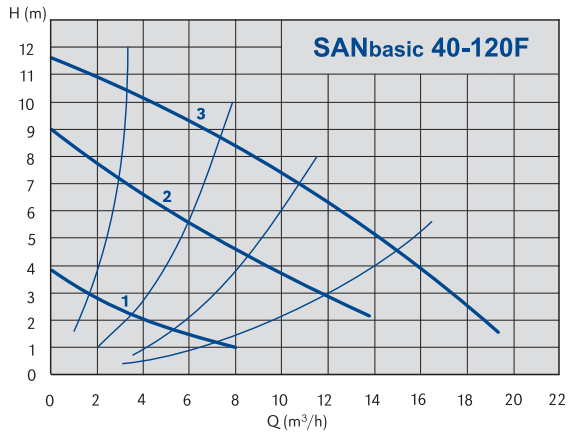

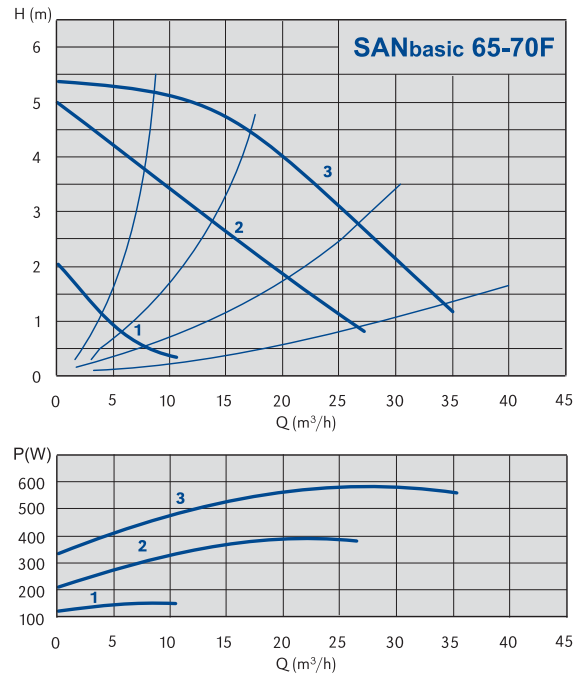
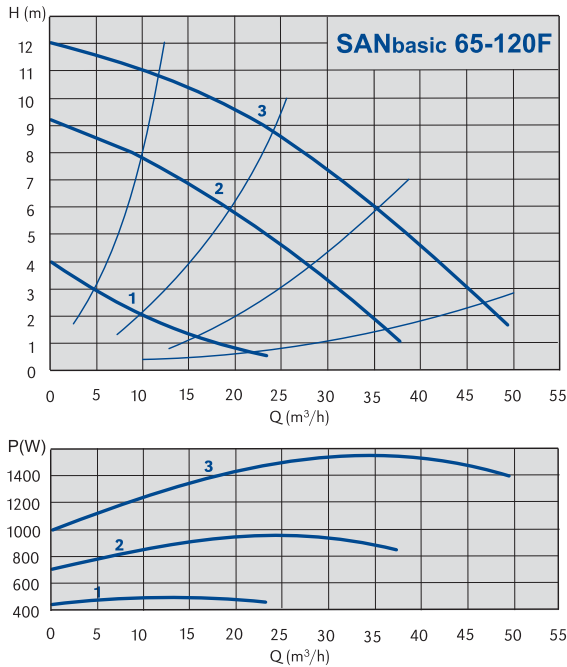

TEHNICAL DATA / TECHNISCHE DATEN

pump type pumpentyp	code artikelnnummer	connection type rohranschluss	max. flow durchfluss Q (m³/h)	max. Head Förder- höhe H (m)	system pressure systemdruck PN (bar)	min. - max. media temperature temp. des medius Tmin-Tmax (°C)	casing type werkstoffe	single-S double-D einzelne-E zwillings- bauform-Z	net weight Reinige- wicht (kg)	regulation geregelt yes /ja no /nein	degree of protection schutzart IP
SAN ECO 15/15 B	979523230	Screw/Gewinde	0,9	1,1	PN 10	+5 - 70	bronze	S/E	0,9	no/nein	44
SAN ECO 15/15 BT	979523233	Screw/Gewinde	0,9	1,1	PN 10	+5 - 70	bronze	S/E	0,9	yes/ja	44
SAN ECO 15/15 BTU	979523232	Screw/Gewinde	0,9	1,1	PN 10	+5 - 70	bronze	S/E	1	yes/ja	44
SAN ECO 15/15 BU	979523231	Screw/Gewinde	0,9	1,1	PN 10	+5 - 70	bronze	S/E	1	yes/ja	44
SAN 15/40-130	979521765	Screw/Gewinde	2,8	3,9	PN 10	+5 - 65	bronze	S/E	2,2	no/nein	44
SAN 20/40-130	979521766	Screw/Gewinde	2,8	3,9	PN 10	+5 - 65	bronze	S/E	2,3	no/nein	44
SAN 25/40-130	979521767	Screw/Gewinde	2,8	3,9	PN 10	+5 - 65	bronze	S/E	2,4	no/nein	44
SAN 15/60-130	979521768	Screw/Gewinde	3,0	5,3	PN 10	+5 - 65	bronze	S/E	2,2	no/nein	44
SAN 20/60-130	979521769	Screw/Gewinde	3,0	5,3	PN 10	+5 - 65	bronze	S/E	2,3	no/nein	44
SAN 25/60-130	979521770	Screw/Gewinde	3,0	5,3	PN 10	+5 - 65	bronze	S/E	2,4	no/nein	44
SAN 20/70-130	979522018	Screw/Gewinde	4,2	6,7	PN 10	+5 - 65	bronze	S/E	2,5	no/nein	44
SAN 25/70-130	979522006	Screw/Gewinde	4,2	6,7	PN 10	+5 - 65	bronze	S/E	2,6	no/nein	44
SANbasic 40-120F	979522875	Flanges/Flansche	20	12	PN 6 / 10	-10 - 65	bronze	S/E	20,5	no/nein	43
SANbasic 40-70F	979522876	Flanges/Flansche	13	6	PN 6 / 10	-10 - 65	bronze	S/E	20,3	no/nein	43
SANbasic 50-120F	979522877	Flanges/Flansche	30	12	PN 6 / 10	-10 - 65	bronze	S/E	26,6	no/nein	43
SANbasic 50-70F	979522878	Flanges/Flansche	25	6	PN 6 / 10	-10 - 65	bronze	S/E	26,3	no/nein	43
SANbasic 65-120F	979522879	Flanges/Flansche	50	12	PN 6 / 10	-10 - 65	bronze	S/E	35,4	no/nein	43
SANbasic 65-70F	979522880	Flanges/Flansche	35	6	PN 6 / 10	-10 - 65	bronze	S/E	33,2	no/nein	43

DIMENSIONS / MAÖE

	pump type pumpentyp	code artikelnummer	length einbaulänge L (mm)	connection size rohranschluss DN	a	l	b1	b2	A	B	C
1	SAN ECO 15/15 B	979523230	65	DN 15							
	SAN ECO 15/15 BT	979523233	65	DN 15					163	150	110
	SAN ECO 15/15 BTU	979523232	65	DN 15					163	150	110
	SAN ECO 15/15 BU	979523231	65	DN 15							
2	SAN 15/40-130	979521765	130	DN 15	28	108	80	44			
	SAN 20/40-130	979521766	130	DN 20	28	108	80	44			
	SAN 25/40-130	979521767	130	DN 25	28	108	80	44			
	SAN 15/60-130	979521768	130	DN 15	28	108	80	44			
	SAN 20/60-130	979521769	130	DN 20	28	108	80	44			
	SAN 25/60-130	979521770	130	DN 25	28	108	80	44			
	SAN 20/70-130	979522018	130	DN 20	28	108	80	44			
	SAN 25/70-130	979522006	130	DN 25	28	108	80	44			
3	SANbasic 40-120F	979522875	250	DN 40	65	198	153	92			
	SANbasic 40-70F	979522876	250	DN 40	65	198	153	92			
	SANbasic 50-120F	979522877	280	DN 50	70	250	160	113			
	SANbasic 50-70F	979522878	280	DN 50	70	250	160	113			
	SANbasic 65-120F	979522879	340	DN 65	80	252	160	123			
	SANbasic 65-70F	979522880	340	DN 65	80	252	160	123			

ELECTRICAL DATA / ELEKTRISCHE DATEN

**MIN WORKING PRESSURE (bar)
MIN ZULASSIGER BETRIEBSDRUCK**

	pump type pumpentyp	code artikelnummer	power max. leistung- aufnahme P (W)	speed range drehzahlstufe (min⁻¹)	FLC I nennstrom In (A)	electrical voltage elektroanschluss U (V)	insulating class isolationsklasse	temperature / temperatur		
								50°C	80°C	110°C
1	SAN ECO 15/15 B	979523230	2-8		0,10	1 ~ 230 V	F			
	SAN ECO 15/15 BT	979523233	2-8		0,10	1 ~ 230 V	F			
	SAN ECO 15/15 BTU	979523232	2-8		0,10	1 ~ 230 V	F			
	SAN ECO 15/15 BU	979523231	2-8		0,10	1 ~ 230 V	F			
2	SAN 15/40-130	979521765	75	1315 - 2456	0,17 - 0,33	1 ~ 230 V	H	0,05	0,4	1,1
	SAN 20/40-130	979521766	75	1315 - 2456	0,17 - 0,33	1 ~ 230 V	H	0,05	0,4	1,1
	SAN 25/40-130	979521767	75	1315 - 2456	0,17 - 0,33	1 ~ 230 V	H	0,05	0,4	1,1
	SAN 15/60-130	979521768	90	1080 - 1980	0,17 - 0,39	1 ~ 230 V	H	0,05	0,4	1,1
	SAN 20/60-130	979521769	90	1080 - 1980	0,17 - 0,39	1 ~ 230 V	H	0,05	0,4	1,1
	SAN 25/60-130	979521770	90	1080 - 1980	0,17 - 0,39	1 ~ 230 V	H	0,05	0,4	1,1
	SAN 20/70-130	979522018	140	1109 - 2340	0,39 - 0,62	1 ~ 230 V	H	0,05	0,4	1,1
	SAN 25/70-130	979522006	140	1109 - 2340	0,39 - 0,62	1 ~ 230 V	H	0,05	0,4	1,1
	SANbasic 40-120F	979522875	578	1250 - 2820	0,36 - 1,46	3 ~ 400 V	200	0,05	0,8	1,4
	SANbasic 40-70F	979522876	295	1440 - 2790	0,18 - 0,74	3 ~ 400 V	200	0,05	0,8	1,4
SANbasic 50-120F	979522877	1020	1270 - 2800	0,46 - 1,73	3 ~ 400 V	200	0,05	0,8	1,4	
SANbasic 50-70F	979522878	470	560 - 1400	0,2 - 1,15	3 ~ 400 V	200	0,3	1	1,6	
SANbasic 65-120F	979522879	1560	1250 - 2810	0,84 - 2,8	3 ~ 400 V	200	0,3	1	1,6	
SANbasic 65-70F	979522880	578	450 - 1370	0,27 - 1,5	3 ~ 400 V	200	0,3	1	1,6	

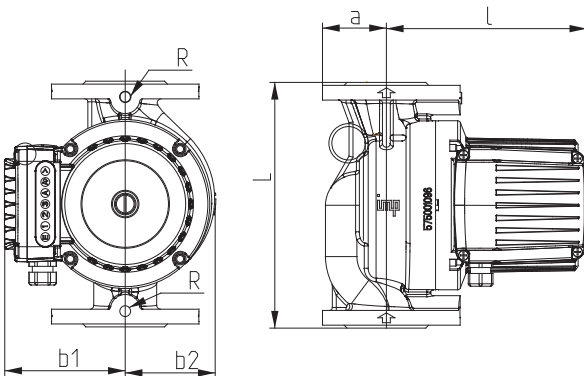
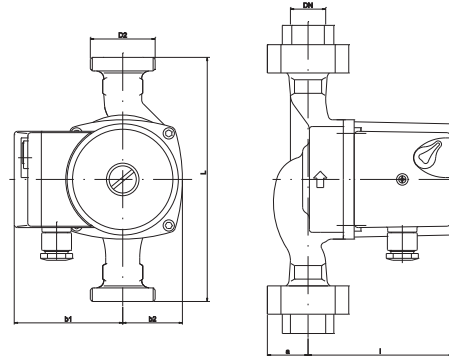
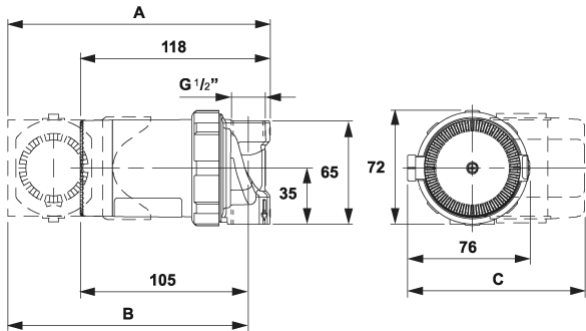

**Pump type SAN
Pumpentyp SAN**

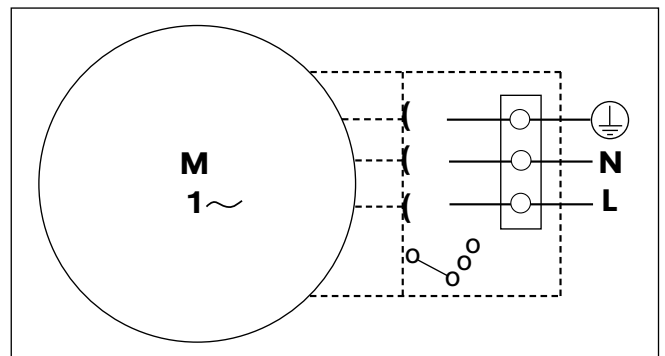

**Pump type SANbasic F are three-phase (3 ~ 400 V / 50 Hz)
Pumpentyp SANbasic F sind dreiphasige Ausführungen (3 ~ 400 V / 50 Hz)**

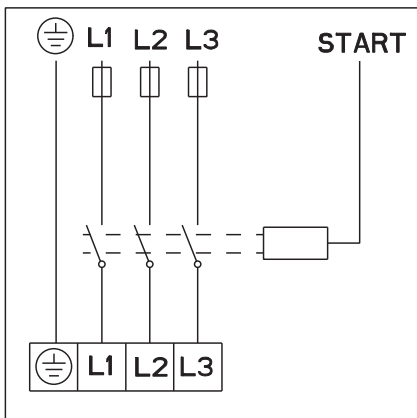

Connection and description of electric connectors:

THREE PHASE CONNECTION

- connection L3:**
Phase L3 (T) power source 3~400 V/50 Hz
- connection L2:**
Phase L2 (S) power source 3~400 V/50 Hz
- connection L1:**
Phase L1 (R) power source 3~400 V/50 Hz

connection ⊕:
Connect to the earth ground wire.

Elektrischer Anschluss:

DREIPHASIGER ANSCHLUSS

- Anschluss L3:**
Phase L3 (T) Stromquelle 3~400 V/50 Hz
- Anschluss L2:**
Phase L2 (S) Stromquelle 3~400 V/50 Hz
- Anschluss L1:**
Phase L1 (R) Stromquelle 3~400 V/50 Hz

Anschluss ⊕:
Erdung

GHN SOL

GHN SOL



**Pumps for solar systems/
Pumpen für Solaranlagen**

Pumps for solar systems
Pumpen für Solaranlagen

TEHNICAL FEATURES / TECHNISCHE MERKMALE		GHN SOL
Connections / Nennweite	DN (")	15, 25
Connection type / Rohranschluss		Screw Type/Gewind
Flow max / Förderstrom max	Q (m ³ /h)	3/5,5
Pressure max / Förderhöhe	H (m)	4/6/7
Pressure rated / Betriebsdruck	PN (bar)	10
Power max / Leistungsaufnahme max	P (W)	75/90/140
Electrical voltage / Elektroanschluss	V	1 ~ 230 V
Degree of protection / Schutzart	IP	44
Regulation / Regelung		no / nein
Media temperature / Temperaturbereich	T(°C)	-10 to/bis +110
Insulating class / Isolationsklasse		H
Casing type / Werkstoffe		GG / Cast iron
Duble pump / Zwillingspumpe		no /nein
APPLICATIONS / EINSATZGEBIETE		
Heating / Warmwasserheizungen		✓
Cooling / Kaltwasseranlagen		✓
Sanitary water / Brauchwasser		
Climate appliances / Klimaanlage		✓
Industry / Industrieanlagen		
Process technique / Verfahrenstechnik		
Condensation / Kondensat		
Salt water / Meerwasser		

Pump markings / Typenschlüssel

GHN SOL 25 / 60 – 130 (180)

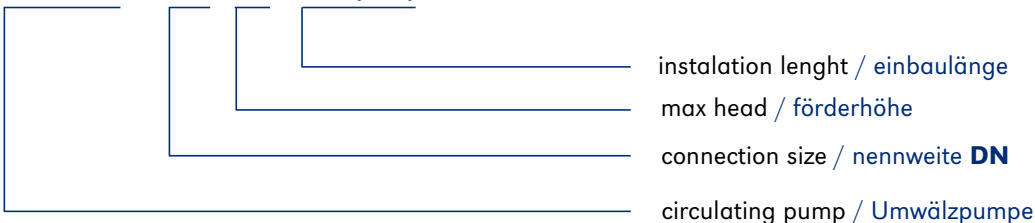

Permitted mounting positions / Einbaumöglichkeiten

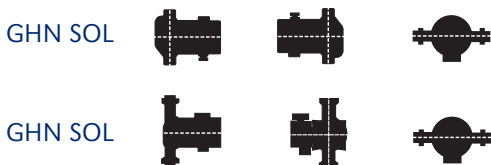

Pumps for solar systems
Pumpen für Solaranlagen

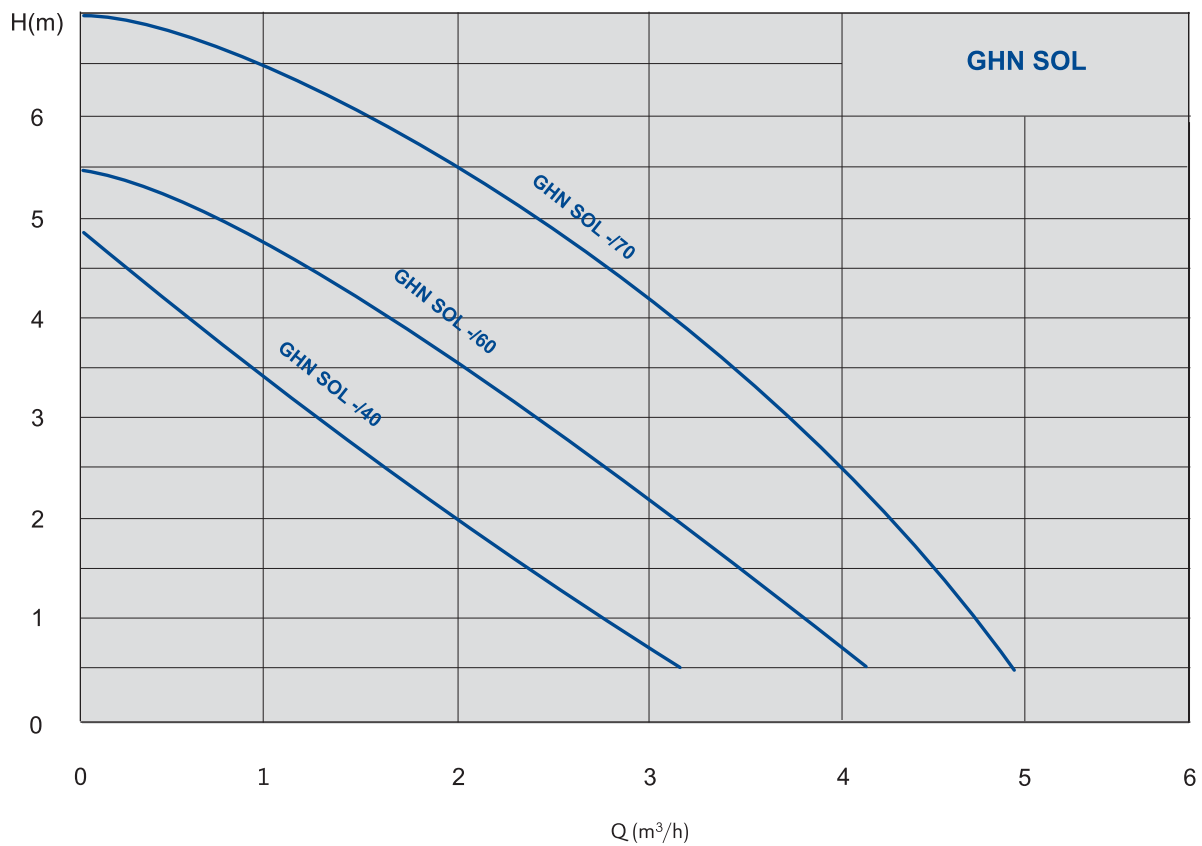
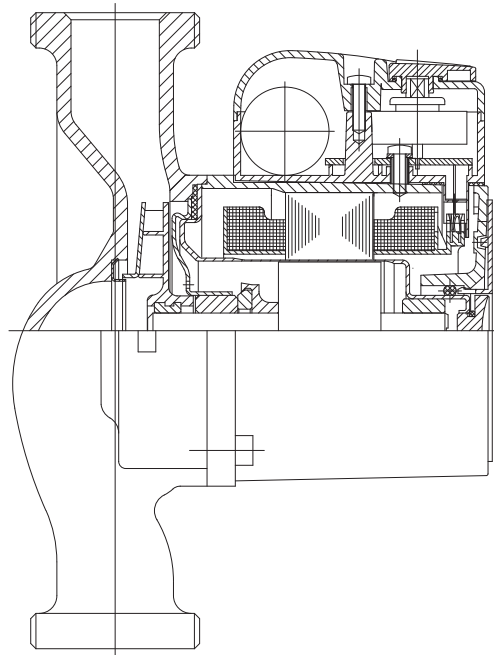

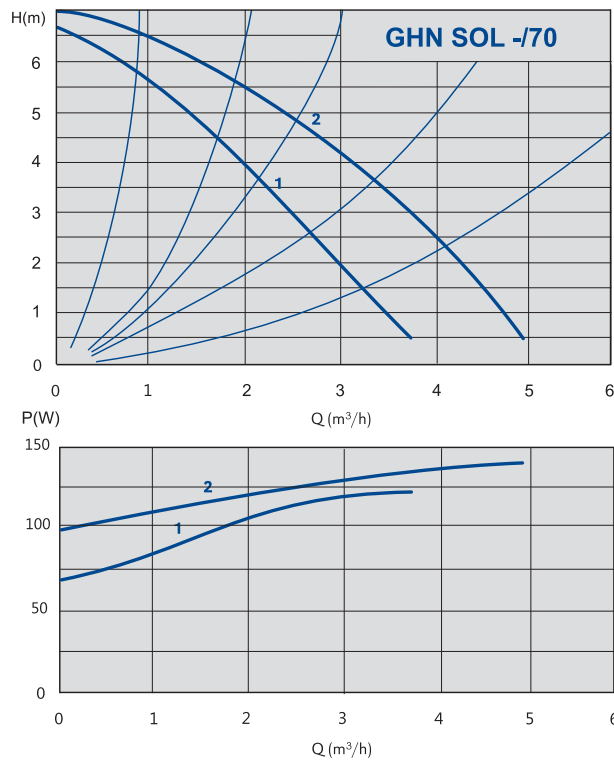
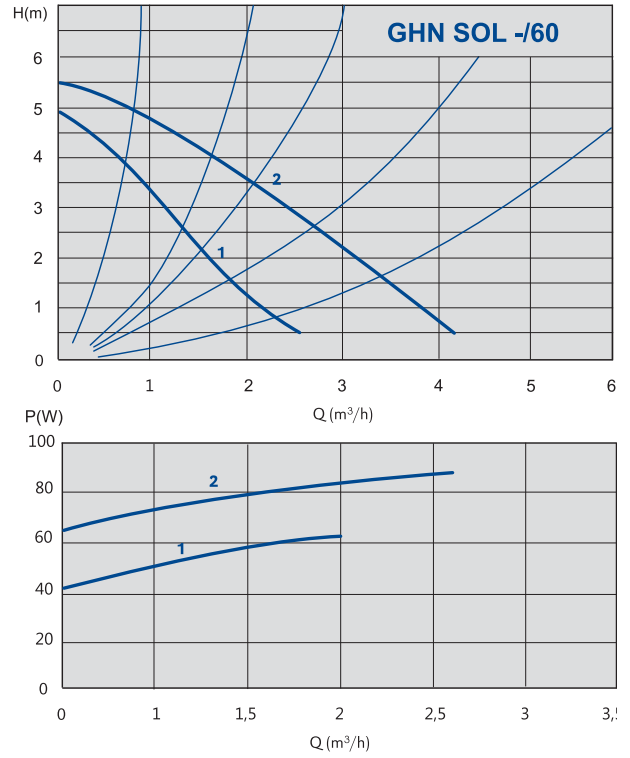
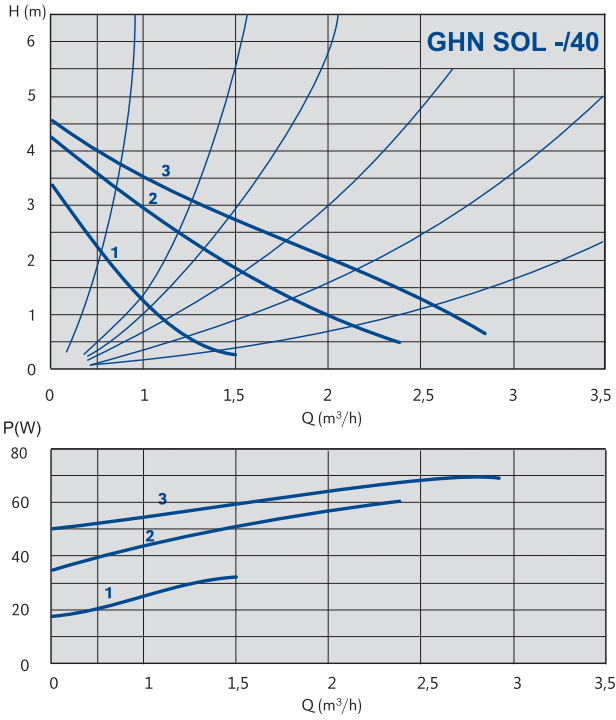

TEHNICAL DATA / TECHNISCHE DATEN

pump type pumpentyp	code artikelnummer	connection type rohranschluss	max. flow durchfluss Q (m ³ /h)	max. Head Förder- höhe H (m)	system pressure systemdruck PN (bar)	min. - max. media temperature temp. des medius Tmin-Tmax (°C)	casing type werkstoffe GG / Cast iron	single-S double-D einzelne-E zwillings- bauform-Z	net weight Reinge- wicht (kg)	regulation geregelt yes /ja no /nein	degree of protection schutzart IP
GHN SOL 15/40-130	979523356	Screw/Gewinde	3	4	PN 10	-10 - +110	GG/CI	S/E	2,1	no/nein	44
GHN SOL 15/60-130	979523359	Screw/Gewinde	3	6	PN 10	-10 - +110	GG/CI	S/E	2,1	no/nein	44
GHN SOL 15/70-130	979523362	Screw/Gewinde	5,5	7	PN 10	-10 - +110	GG/CI	S/E	2,3	no/nein	44
GHN SOL 25/40-130	979523357	Screw/Gewinde	3	4	PN 10	-10 - +110	GG/CI	S/E	2,3	no/nein	44
GHN SOL 25/60-130	979521360	Screw/Gewinde	3	6	PN 10	-10 - +110	GG/CI	S/E	2,3	no/nein	44
GHN SOL 25/70-130	979521363	Screw/Gewinde	5,5	7	PN 10	-10 - +110	GG/CI	S/E	2,4	no/nein	44
GHN SOL 25/40-180	979521358	Screw/Gewinde	3	4	PN 10	-10 - +110	GG/CI	S/E	2,6	no/nein	44
GHN SOL 25/60-180	979521361	Screw/Gewinde	3	6	PN 10	-10 - +110	GG/CI	S/E	2,6	no/nein	44
GHN SOL 25/70-180	979521364	Screw/Gewinde	5,5	7	PN 10	-10 - +110	GG/CI	S/E	2,7	no/nein	44

DIMENSIONS / MAßE

pump type pumpentyp	code artikelnummer	length einbaulänge L (mm)	connection size rohranschluss DN	a	l	b1	b2	R	b	h1
GHN SOL 15/40-130	979523356	130	DN 15	27	108	80	44			
GHN SOL 15/60-130	979523359	130	DN 15	27	108	80	44			
GHN SOL 15/70-130	979523362	130	DN 15	27	108	80	44			
GHN SOL 25/40-130	979523357	130	DN 25	32	108	80	44			
GHN SOL 25/60-130	979521360	130	DN 25	32	108	80	44			
GHN SOL 25/70-130	979521363	130	DN 25	32	108	80	44			
GHN SOL 25/40-180	979521358	180	DN 25	32	108	80	44			
GHN SOL 25/60-180	979521361	180	DN 25	32	108	80	44			
GHN SOL 25/70-180	979521364	180	DN 25	32	108	80	44			

ELECTRICAL DATA / ELEKTRISCHE DATEN

pump type pumpentyp	code artikelnummer	power max. leistung- saufnahme P (W)	speed range drehzahlstufe (min-1)	FLC I nennstrom In (A)	electrical voltage elektroanschluss U (V)	insulating class isoliationsklasse	MIN WORKING PRESSURE (bar) MIN ZULASSIGER BETRIEBSDRUCK		
							temperature / temperatur		
							50°C	80°C	110°C
GHN SOL 15/40-130	979523356	75	1630 - 2456	0,25-0,33	1 ~ 230 V	H	0,05	0,4	1,1
GHN SOL 15/60-130	979523359	90	1460 - 1980	0,29-0,39	1 ~ 230 V	H	0,05	0,4	1,1
GHN SOL 15/70-130	979523362	140	1720 - 2340	0,57-0,61	1 ~ 230 V	H	0,05	0,4	1,1
GHN SOL 25/40-130	979523357	75	1630 - 2456	0,25-0,33	1 ~ 230 V	H	0,05	0,4	1,1
GHN SOL 25/60-130	979521360	90	1460 - 1980	0,29-0,39	1 ~ 230 V	H	0,05	0,4	1,1
GHN SOL 25/70-130	979521363	140	1720 - 2340	0,57-0,61	1 ~ 230 V	H	0,05	0,4	1,1
GHN SOL 25/40-180	979521358	75	1630 - 2456	0,25-0,33	1 ~ 230 V	H	0,05	0,4	1,1
GHN SOL 25/60-180	979521361	90	1460 - 1980	0,29-0,39	1 ~ 230 V	H	0,05	0,4	1,1
GHN SOL 25/70-180	979521364	140	1720 - 2340	0,57-0,61	1 ~ 230 V	H	0,05	0,4	1,1

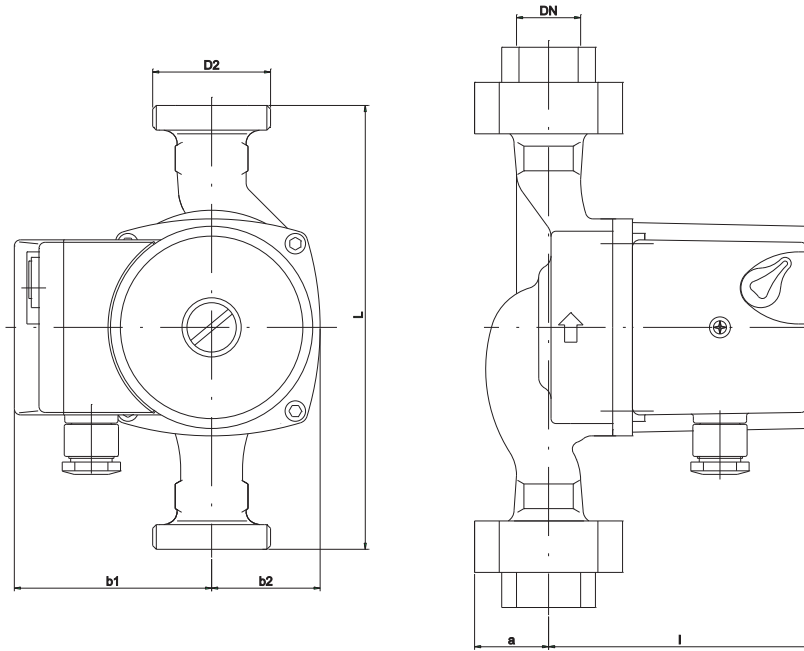

Pump type SOL
Pumpentyp SOL

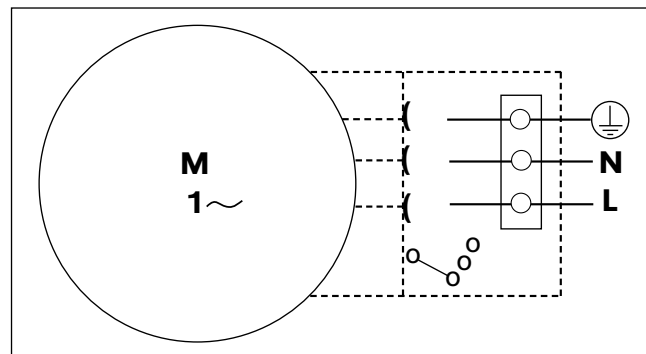

ECL

ECL



**Electronically controlled in-line pumps /
Elektronisch geregelte Trockenläuferpumpen**



Electronically controlled in-line pumps Elektronisch geregelte Trockenläuferpumpen

ADVANTAGES AND CLARIFICATIONS FOR INSTALLING ELECTRONICALLY REGULATED PUMPS

Saving of energy and money

Due to their regulation of revolutions per minute and power of the motor, electronically regulated pumps attain significantly better conditions of investing energy and work - compared with non-regulated pumps they save on electricity and money.

Optimal adaptation of variables required by the hydraulic system

A wide set-up of hydraulic parameters enables optimal adaptation of the pump to the requirements of the heating system and minimum consumption of electricity.

Noiseless and peaceful operation

The system with electronically regulated pumps runs noiselessly even in the event of heating with thermostatic valves. Due to adapting variables in the system, regulated pumps provide optimal hydraulic balance in the system in all conditions.

Operational safety

Electronically regulated pumps are protected against overloading, short circuits, excessive voltage and excessive temperature.

Reducing environmental pollution

Due to the efficient use of electrical energy, electronically regulated pumps are less burdensome to the environment.

Simplifying projects and reducing costs of mechanical installation

Electronically regulated pumps simplify making projects and the design of mechanical installation.

In some countries the government has legislated to take into account these advantages. For example the German decree of 1994 on heating appliances prescribes circulation pumps for boilers over 50 kW must have at least a three-stage automatic regulation.

VORTEILE UND GRÜNDE FÜR DEN EINBAU ELEKTRONISCH REGULIERTER PUMPEN

Einsparung von Energie und Geld

Die elektronisch regulierten Pumpen erreichen wegen ihrer selbsttätigen Regulierung der Drehzahl und der Motorleistung ein wesentlich besseres Verhältnis zwischen eingebrachter Energie und verrichteter Arbeit, im Vergleich mit nicht regulierten Pumpen ermöglichen sie eine große Einsparung an elektrischer Energie und Geld.

Optimale Anpassung an veränderliche Erfordernisse des hydraulischen Systems

Das weite Feld der Einstellung der hydraulischen Parameter ermöglicht eine optimale Anpassung der Pumpe an die Erfordernisse des Heizsystems bei minimalem Stromverbrauch.

Geräuschloses und ruhiges Funktionieren

Das System mit elektronisch regulierten Pumpen arbeitet geräuschlos auch bei Heizkörpern mit angebauten Thermostatventil. Aufgrund der Anpassung an Veränderungen im System gewährleisten regulierte Pumpen bei allen Verhältnissen ein optimales hydraulisches Gleichgewicht im System.

Funktionsschutz

Elektronisch regulierte Pumpen sind gegen Überlastung, Kurzschluss, Überspannung und gegen zu hohe Temperaturen geschützt.

Verringerung der Umweltverschmutzung

Aufgrund der hohen Auslastung der eingebrachten Energie wird die Umwelt durch elektronisch regulierte Pumpen weniger belastet.

Vereinfachung der Projektierung und Kostenverringerung der Maschineninstallation

Elektronisch regulierte Pumpen vereinfachen dem Projektanten das Projektieren und auch die Ausführung der Maschineninstallation selbst ist einfacher.

Diese Vorteile wurden in einigen Staaten auch von den Regierungen berücksichtigt und eine entsprechende Gesetzgebung vorbereitet.

Electronically controlled in-line pumps Elektronisch geregelte Trockenläuferpumpen

ELECTRONICALLY REGULATED PUMPS ECL

The ECL electronically regulated pumps provide various media flows in equal or lower heights in changing hydraulic resistances in the system. Changing resistance in the system is normally linked to the operation of hydraulic valves - these changes are recognised by a special pump sensor. A special algorithm in the electronically regulated pump then raises or lowers the rpm of the pump motor with respect to changes in resistance at constant or proportional pressure. Automatic operation of the pump is therefore achieved by setting the pressure for various resistances in the closed loop system of central heating.

ECL pumps with separate frequency converter

The ECL pump with separate frequency converter comprises pump, pressure difference measurer (built into the pump) and separately installed frequency converter (placed on the wall inside or outside the room with the pump). This pump can perform the following functions:

Automatic regulation of constant pressure difference

The automatic regulation of constant ΔpC is used in dual-pipe systems with thermostatic valves and large user influence such as:

- Devices with working point at low pressure difference
- Devices with strongly choked valves of raised pipes
- Devices with low pressure drops in parts of the system with joint flow (boilers, heat exchangers, joint networks)

Operation by maximum curve

Operation by maximum curve is the same as the operation of a non-regulated pump at the highest speed. This method is used in attempting to start a device or in the event of regulation breakdown.

Connection of the ECL pump to the electricity grid

All types of ECL pump have series three-phase connection of frequency converter to the electricity grid.

So schreibt die deutsche Verordnung für Heizanlagen aus dem Jahre 1994 vor, dass Umlaufpumpen bei einer Kesselleistung von über 50 kW mit mindestens dreistufigen selbstständigen Regulationen ausgestattet sein müssen.

ELEKTRONISCH REGULIERTE PUMPEN ECL

Die elektronisch regulierten Pumpen ECL gewährleisten verschiedene Durchflüsse von Medien bei gleicher oder niedriger Druckhöhe bei veränderlichen hydraulischen Widerständen im System. Widerstandsveränderungen im System sind in der Regel mit dem Funktionieren der Thermostatventile verbunden - diese Veränderungen nimmt ein spezieller Fühler der Pumpe wahr. Abhängig von der Widerstandsveränderung im System erhöht oder verringert danach ein besonderer Algorithmus in der Steuerelektronik der Pumpe die Anzahl der Umdrehungen im Pumpenmotor bei konstantem oder proportionellem Druck. Dadurch erreichen wir das selbstständige Funktionieren der Pumpen bei eingestelltem Druck für verschiedene Widerstände im geschlossenen Kreis des Zentralheizungssystems.

ECL Pumpen mit getrenntem Frequenzumspanner

Die Ausführung der ECL Pumpe mit getrenntem Frequenzumspanner besteht aus der Pumpe, dem Druckunterschiedsmesser (angebaut an der Pumpe) und dem getrennt angebrachten Frequenzumspanner (angebracht an der Wand des Raumes, in dem sich die Pumpe befindet oder außerhalb des Raumes). Diese Pumpen erfüllen folgende Funktionen:

Selbstständige Regulierung des konstanten Druckunterschiedes

Selbstständige Regulierung des konstanten ΔpC wird angewandt bei doppelläufigen Systemen mit Thermostatventilen sowie bei großen autoritären Verbrauchern, wie:

- Anlagen mit einem Arbeitspunkt bei niedrigem Druckunterschied,
- Anlagen mit starken Drosselventilen für Steigleitungen
- Anlagen mit niedrigem Druckabfall in Systemteilen mit einem gemeinsamen Umspanner (Kessel, Wärmeaustauscher, gemeinsames Netz).

Electronically controlled in-line pumps **Elektronisch geregelte Trockenläuferpumpen**

Funktionieren gemäß minimaler Kurve

Das Funktionieren gemäß der minimalen Kurve entspricht dem Funktionieren bei niedrigster Geschwindigkeit. Diese Art wird angewandt bei nächtlicher Verringerung der Heizleistung, bei Bedarfsverringern an Wochenenden oder in Urlaubszeiten (in Schulen, in Institutionen...). Es wird mithilfe einer Schaltuhr eingeschaltet.

Anschluss der ECL Pumpen an das Stromnetz

Alle Typen der EGHN Pumpen verfügen über einen serienmäßigen Dreiphasenanschluss des Frequenzumspanner an das Stromnetz.

Electronically controlled in-line pumps Elektronisch geregelte Trockenläuferpumpen

TEHNICAL FEATURES / TECHNISCHE MERKMALE		ECL
Connections / Nennweite	DN (")	32 do 100
Connection type / Rohranschluss		Flanges / Flansche
Flow max / Förderstrom max	Q (m ³ /h)	160
Pressure max / Förderhöhe	H (m)	60
Pressure rated / Betriebsdruck	PN (bar)	8 / 10
Power max / Leistungsaufnahme max	P (W)	22000
Electrical voltage / Elektroanschluss	V	3 ~ 400 V
Degree of protection / Schutzart	IP	54
Regulation / Regelung		no / nein
Media temperature / Temperaturbereich	T(°C)	-15 do +140
Insulating class / Isolationsklasse		F
Casing type / Werkstoffe		GG / Cast iron
Duble pump / Zwillingspumpe		no / nein
APPLICATIONS / EINSATZGEBIETE		
Heating / Warmwasserheizungen		✓
Cooling / Kaltwasseranlagen		✓
Sanitary water / Brauchwasser		
Climate appliances / Klimaanlage		✓
Industry / Industrieanlagen		✓
Process technique / Verfahrenstecnik		✓
Condensation / Kondensat		✓
Salt water / Meerwasser		

Pump markings / Typenschlüssel

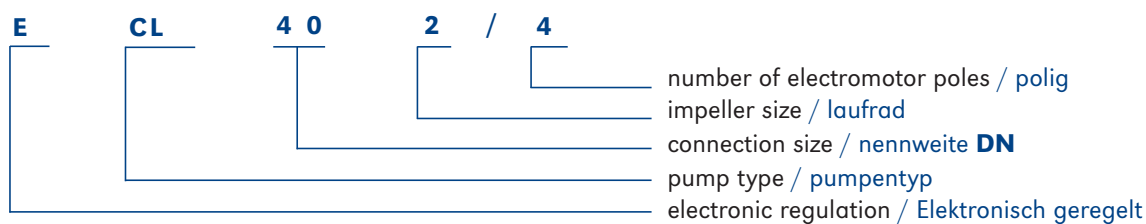

Permitted mounting positions / Einbaumöglichkeiten

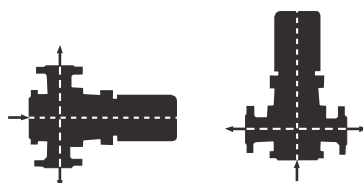

In-line pumps with separate frequency converter
Elektronisch geregelte Inlinepumpen mit integrierter Differenzdruckregelung
mit abwickelbar Frequenzumformer

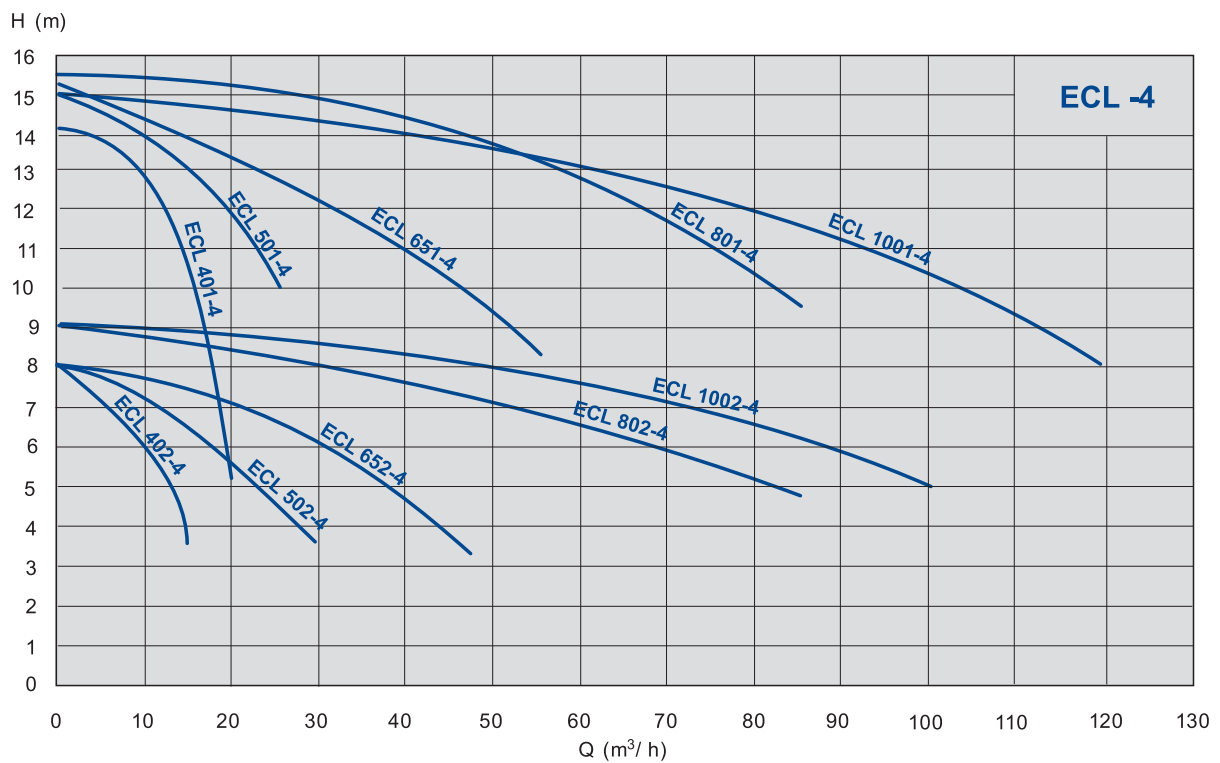
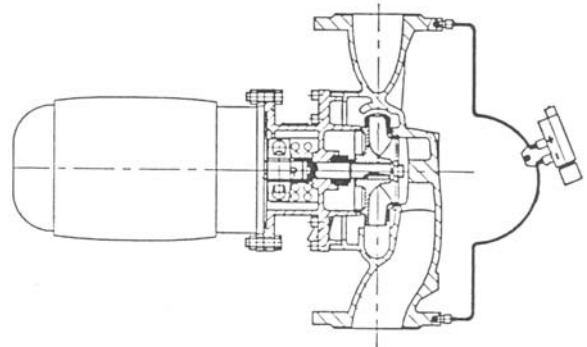
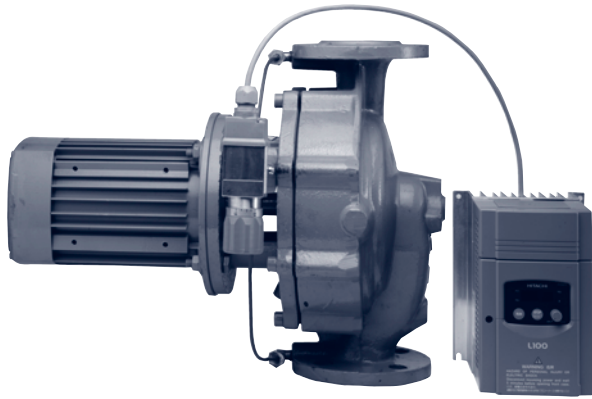

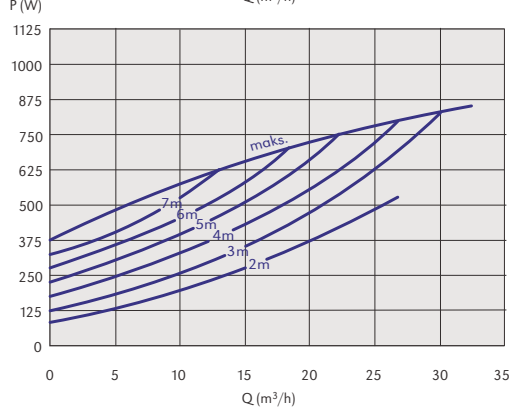
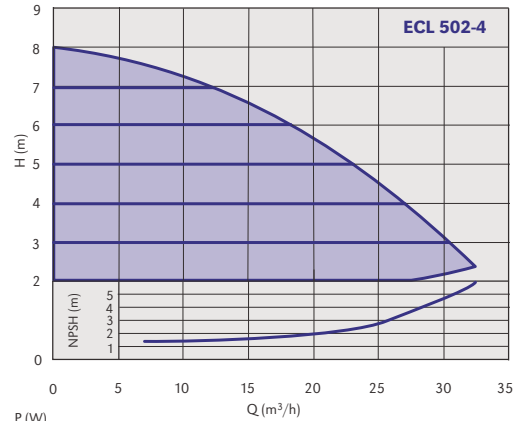
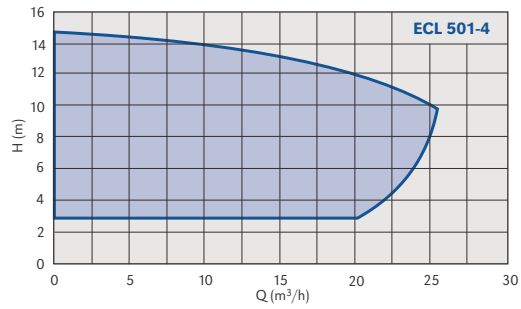
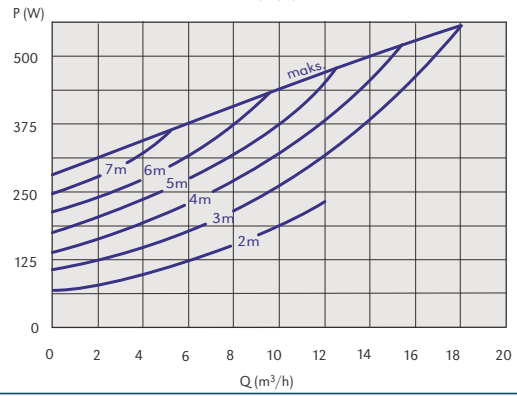
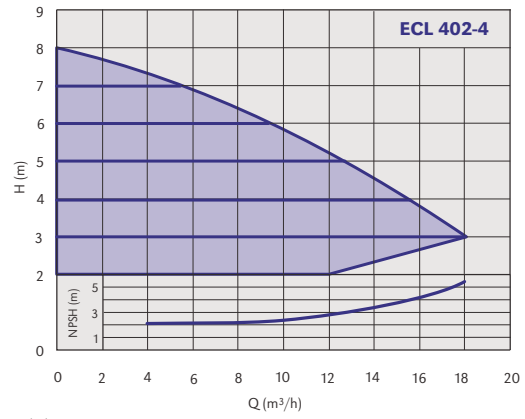
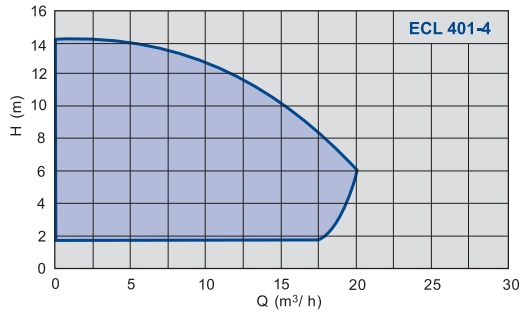
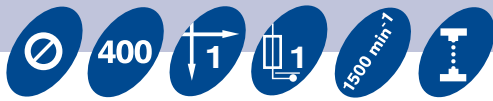

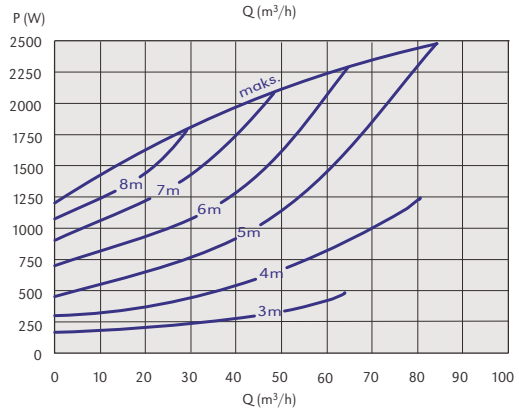
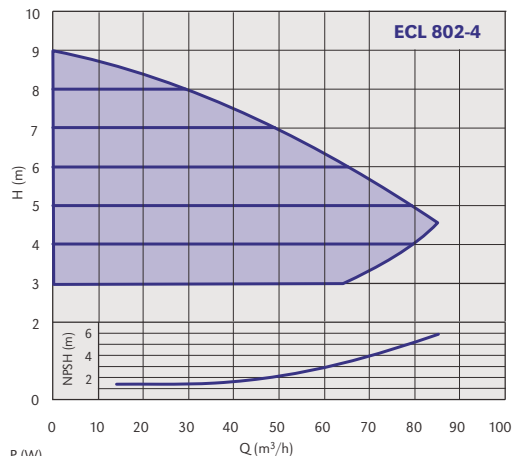
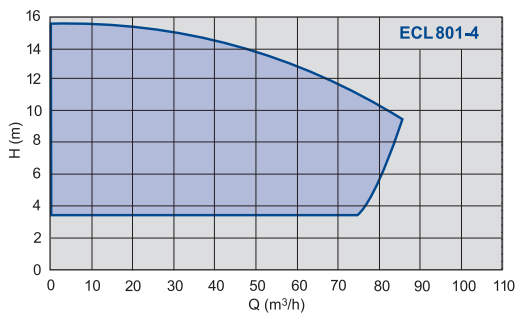
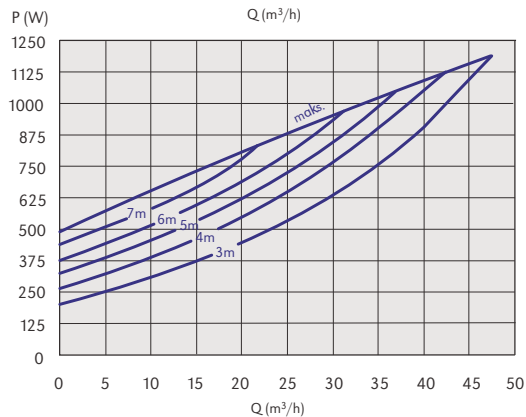
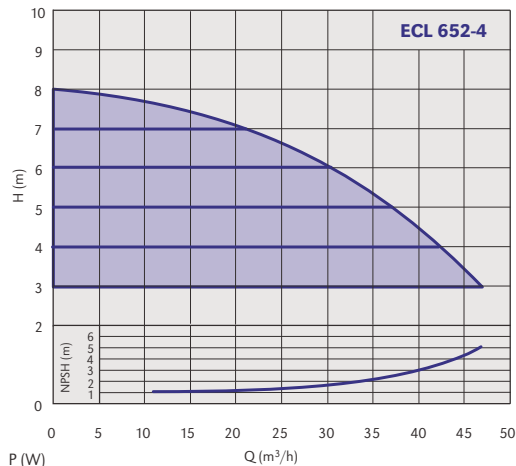
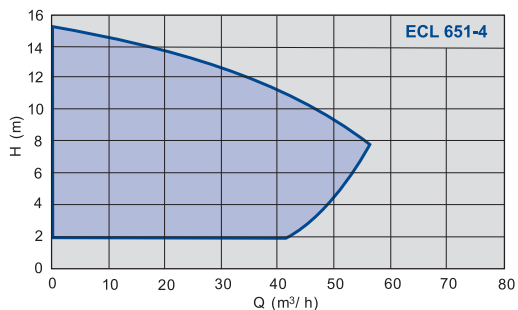

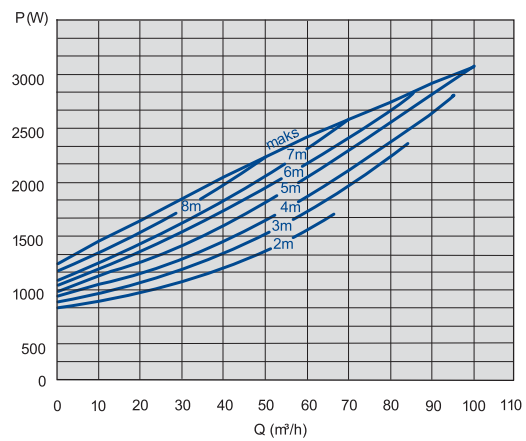
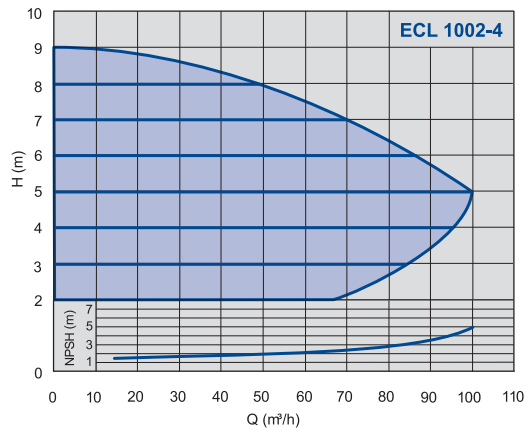
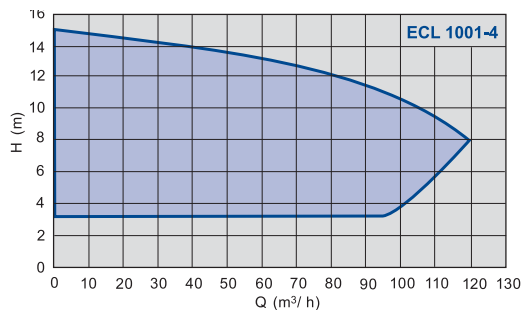

In-line pumps with separate frequency converter
Elektronisch geregelte Inlinepumpen mit integrierter Differenzdruckregelung
mit abwickelbar Frequenzumformer

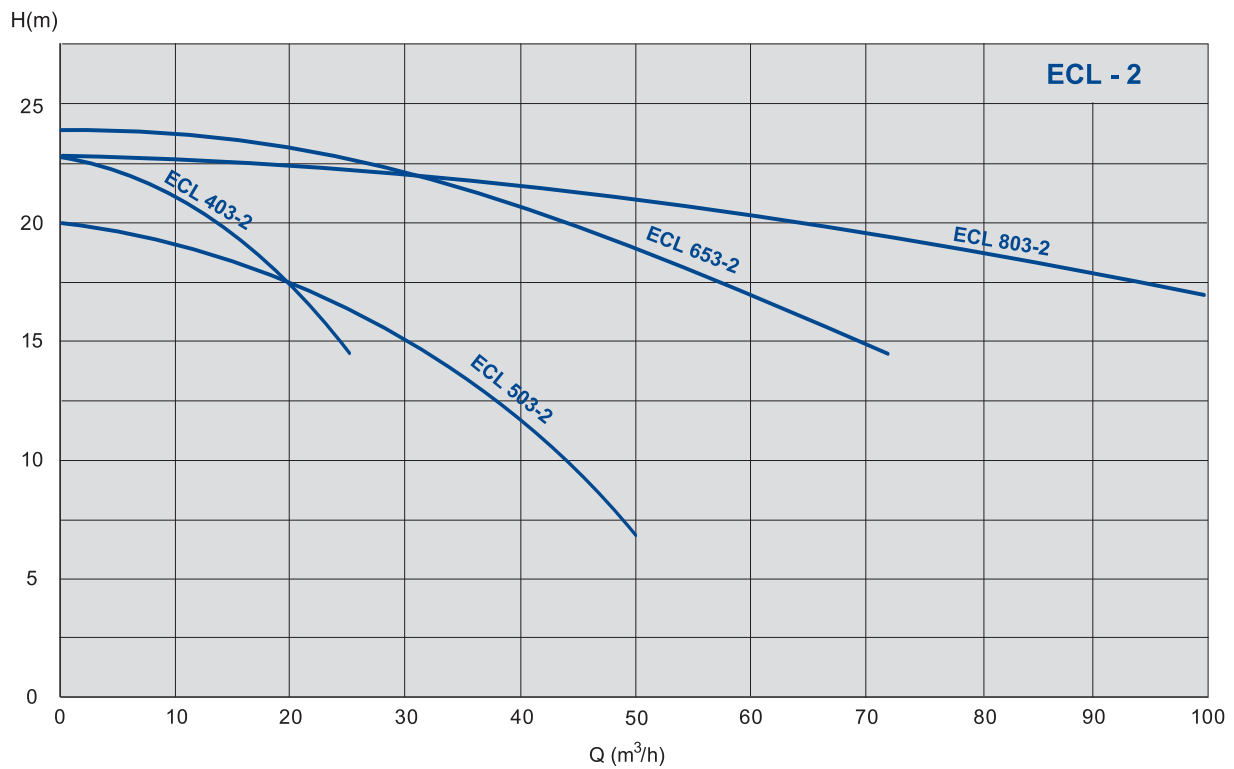
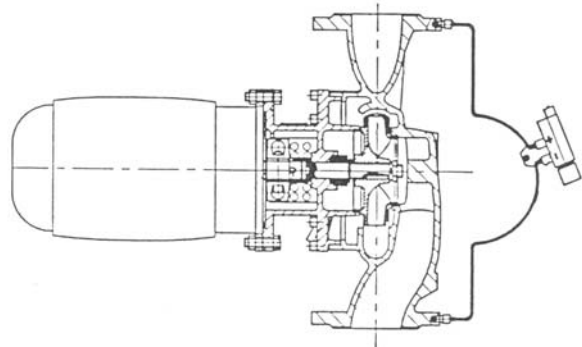
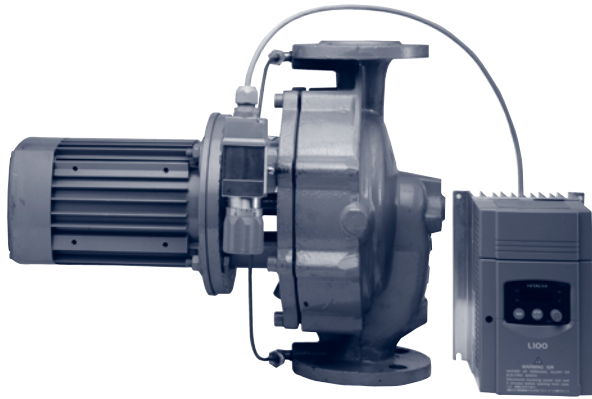

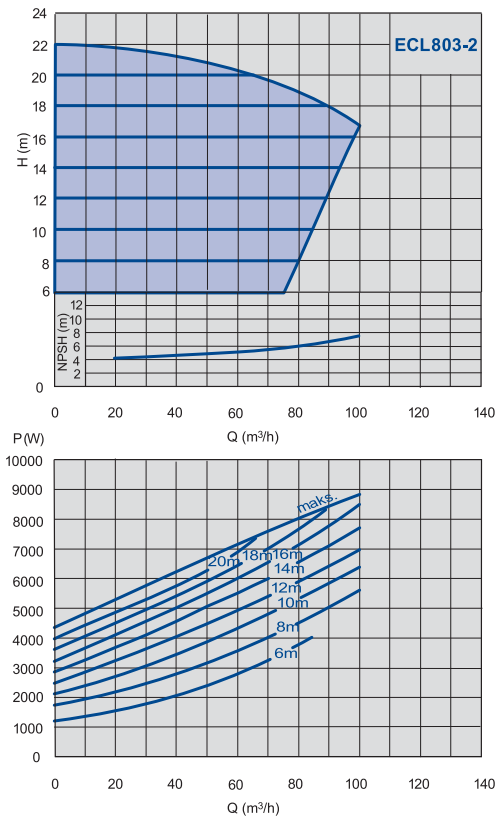
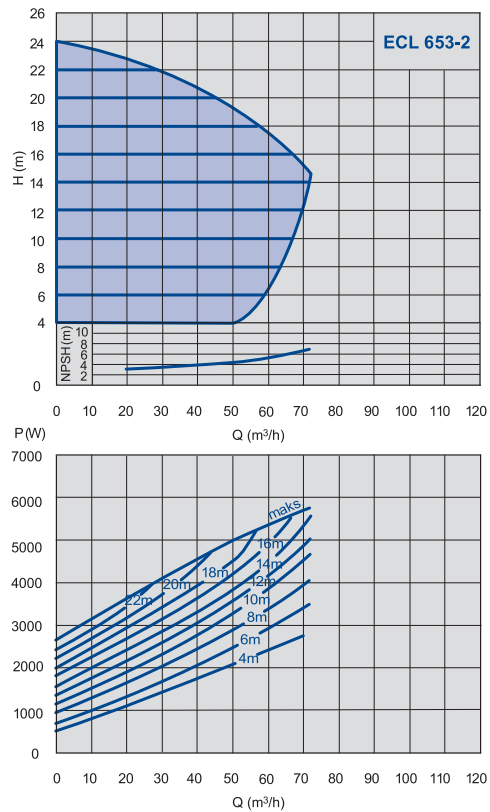
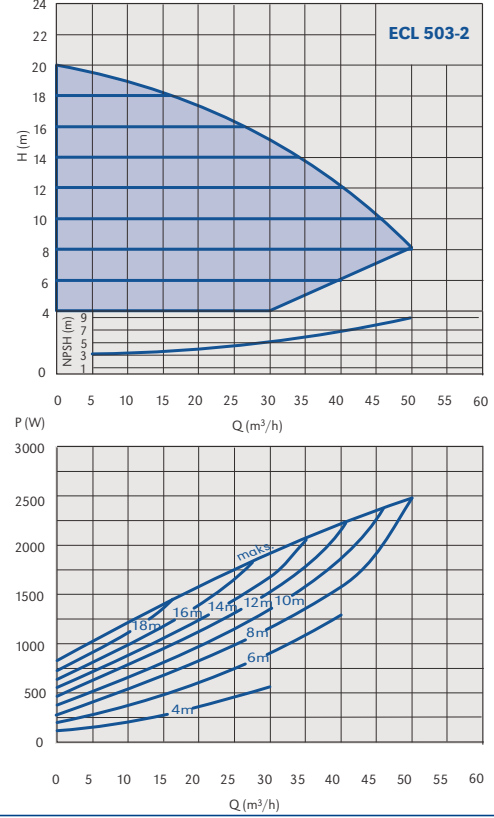
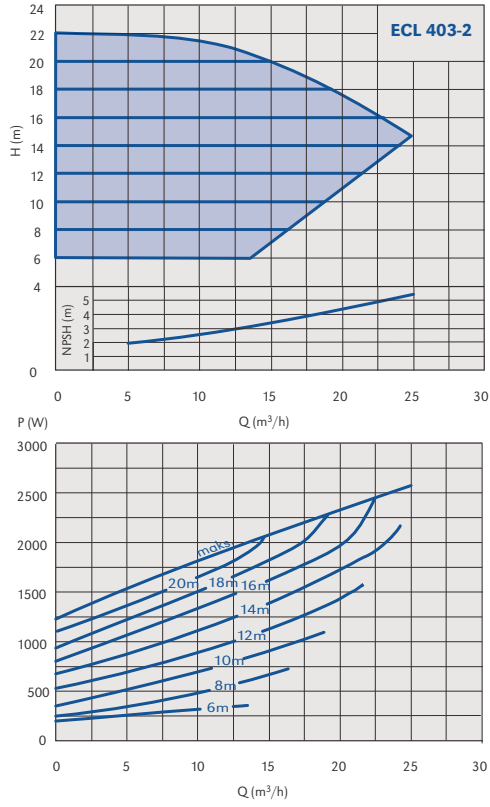
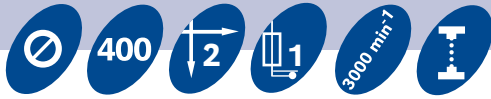

TEHNICAL DATA / TECHNISCHE DATEN

pump type pumpentyp	code artikelnummer	connection size rohranschluss DN (")	connection type rohranschluss	max. flow durchfluss Q (m ³ /h)	max. pressure druck H (m)	system pressure systemdruck PN (bar)	min. media temp. temp. des mediums T min.°C	max. media temp. temp. des mediums T max.°C	casing type werkstoffe GG / Cast iron	single-S, double-D einzelne-E, zwillings- bauform-Z	net weight Rein- gewicht (kg)	regulation geregelt yes /ja no /nein	degree of protection schutzart IP
ECL 401 - 4	979521416	DN 40	flanges/flansche	20	15	PN 16	-15	140	GG/CI	S/E	50	yes/ja	54
ECL 402 - 4	979521417	DN 40	flanges/flansche	18	8	PN 16	-15	140	GG/CI	S/E	45	yes/ja	54
ECL 501 - 4	979521690	DN 50	flanges/flansche	26	15	PN 16	-15	140	GG/CI	S/E	52	yes/ja	54
ECL 502 - 4	979521420	DN 50	flanges/flansche	29	8	PN 16	-15	140	GG/CI	S/E	49	yes/ja	54
ECL 651 - 4	979521422	DN 65	flanges/flansche	56	15	PN 16	-15	140	GG/CI	S/E	65	yes/ja	54
ECL 652 - 4	979521423	DN 65	flanges/flansche	47	8	PN 16	-15	140	GG/CI	S/E	53	yes/ja	54
ECL 801 - 4	979521425	DN 80	flanges/flansche	85	15	PN 16	-15	140	GG/CI	S/E	80	yes/ja	54
ECL 802 - 4	979521426	DN 80	flanges/flansche	85	9	PN 16	-15	140	GG/CI	S/E	72	yes/ja	54
ECL 1001 - 4	979521428	DN 100	flanges/flansche	119	15	PN 16	-15	140	GG/CI	S/E	88	yes/ja	54
ECL 1002 - 4	979521429	DN 100	flanges/flansche	100	9,5	PN 16	-15	140	GG/CI	S/E	87	yes/ja	54
ECL 403 - 2	979521445	DN 40	flanges/flansche	25	22	PN 16	-15	140	GG/CI	S/E	45	yes/ja	54
ECL 503 - 2	979521444	DN 50	flanges/flansche	50	20	PN 16	-15	140	GG/CI	S/E	73	yes/ja	54
ECL 653 - 2	979521443	DN 65	flanges/flansche	72	24	PN 16	-15	140	GG/CI	S/E	83	yes/ja	54
ECL 803 - 2	979521442	DN 80	flanges/flansche	100	22	PN 16	-15	140	GG/CI	S/E	113	yes/ja	54

DIMENSIONS / MAÖE

pump type pumpentyp	code artikelnummer	length einbaulänge L (mm)	DN	a	f	l1	l	h1	h2	D1	D2	D3	no. hole
ECL 401 - 4	979521416	390	40	90	155	234	479	190	200	150	110	18	4
ECL 402 - 4	979521417	360	40	90	155	234	479	180	180	150	110	18	4
ECL 501 - 4	979521690	425	50	96	159	249	504	205	220	165	125	18	4
ECL 502 - 4	979521420	380	50	96	159	249	504	180	200	165	125	18	4
ECL 651 - 4	979521422	480	65	95	164	249	508	225	255	185	145	18	4
ECL 652 - 4	979521423	420	65	95	164	249	508	200	220	185	145	18	4
ECL 801 - 4	979521425	530	80	103	168	307	578	245	285	200	160	18	8
ECL 802 - 4	979521426	480	80	103	168	307	578	220	260	200	160	18	8
ECL 1001 - 4	979521428	560	100	113	169	307	589	270	290	220	180	18	8
ECL 1002 - 4	979521429	520	100	113	169	307	589	245	275	220	180	18	8
ECL 403 - 2	979521445	340	40	90	155	314	559	160	180	150	110	18	4
ECL 503 - 2	979521444	340	50	96	159	314	569	160	180	165	125	18	4
ECL 653 - 2	979521443	390	65	95	189	361	645	180	210	185	145	18	4
ECL 803 - 2	979521442	440	80	103	193	357	653	200	240	200	160	18	8

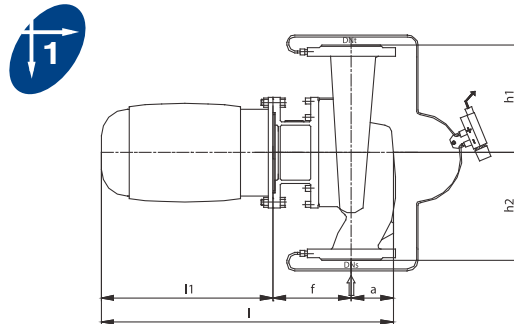

ELECTRICAL DATA / ELEKTRISCHE DATEN

pump type pumpentyp	code artikelnummer	power max. leistungsaufnahme P (W)	speed range drehzahlstufe (min ⁻¹)	FLC I nennstrom In (A)	electrical voltage elektroanschluss U (V)	insulating class isolationsklasse
ECL 401 - 4	979521416	1100	650 - 1400	2,4	3 ~ 400 V	F
ECL 402 - 4	979521417	750	650 - 1400	1,63	3 ~ 400 V	F
ECL 501 - 4	979521690	1500	650 - 1400	3,26	3 ~ 400 V	F
ECL 502 - 4	979521420	1100	650 - 1400	2,4	3 ~ 400 V	F
ECL 651 - 4	979521422	2200	650 - 1400	4,64	3 ~ 400 V	F
ECL 652 - 4	979521423	1100	650 - 1400	2,4	3 ~ 400 V	F
ECL 653 - 4	979521424	750	650 - 1400	4,63	3 ~ 400 V	F
ECL 801 - 4	979521425	3000	650 - 1400	6,17	3 ~ 400 V	F
ECL 802 - 4	979521426	2200	650 - 1400	4,64	3 ~ 400 V	F
ECL 803 - 4	979521971	1100	650 - 1400	2,4	3 ~ 400 V	F
ECL 1001 - 4	979521428	4000	650 - 1400	8,11	3 ~ 400 V	F
ECL 1002 - 4	979521429	3000	650 - 1400	6,17	3 ~ 400 V	F
ECL 403 - 2	979521445	3000	1400 - 2850	5,92	3 ~ 400 V	F
ECL 503 - 2	979521444	3000	1400 - 2850	5,92	3 ~ 400 V	F
ECL 653 - 2	979521443	5500	1400 - 2850	10,6	3 ~ 400 V	F
ECL 803 - 2	979521442	7500	1400 - 2850	14,1	3 ~ 400 V	F
ECL 802 - 2	979522007	18500	1400 - 2850	33,7	3 ~ 400 V	F
ECL 801 - 2	979522751	22000	1400 - 2850	39,1	3 ~ 400 V	F
ECL 652 - 2	979521580	7500	1400 - 2850	14,1	3 ~ 400 V	F
ECL 651 - 2	979521512	15000	1400 - 2850	27,6	3 ~ 400 V	F
ECL 502 - 2	979521458	5500	1400 - 2850	10,6	3 ~ 400 V	F
ECL 402 - 2	979521820	4000	1400 - 2850	7,72	3 ~ 400 V	F
ECL 401 - 2	979521813	5500	1400 - 2850	10,6	3 ~ 400 V	F

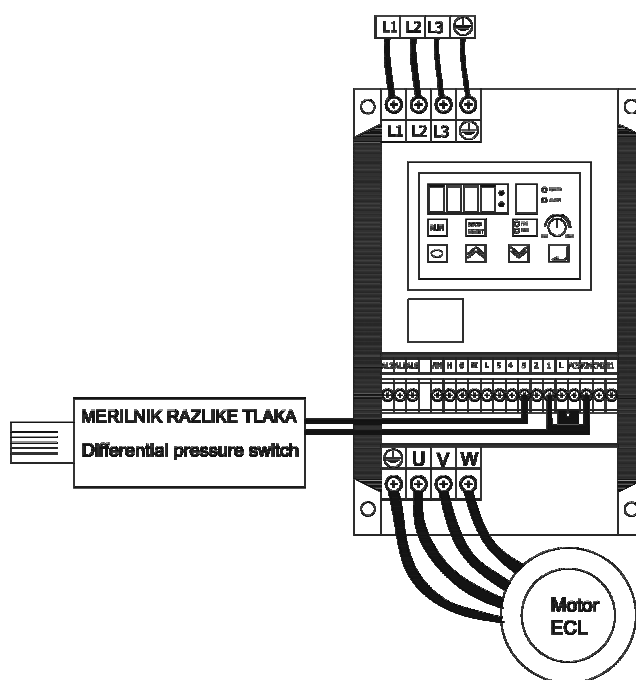



IMPPUMPS

THE HONEST PRODUCT FOR THE HONEST PRICE

GHN



CIRCULATING
PUMP

UMWÄLZPUMPE

CV / CL / CLD

CV / CL / CLD



In-line pumps /
Trockenläuferpumpen



In-line pumps Trockenläuferpumpen

TEHNIICAL FEATURES / TECHNISCHE MERKMALE		CV	CL	CLD
Connections / Nennweite	DN (")	32	32 do 150	40 do 100
Connection type / Rohranschluss		Flanges / Flansche	Flanges / Flansche	Flanges / Flansche
Flow max / Förderstrom max	Q (m ³ /h)	14	160	280
Pressure max / Förderhöhe	H (m)	6	60	60
Pressure rated / Betriebsdruck	PN (bar)	10 / 16	16	16
Power max / Leistungsaufnahme max	P (W)	250	37000	22000
Electrical voltage / Elektroanschluss	V	3 ~ 400 V	3 ~ 400 V	3 ~ 400 V
Degree of protection / Schutzart	IP	54	55	55
Regulation / Regelung		no / nein	optional	optional
Media temperature / Temperaturbereich	T(°C)	-10 to/bis +110	-10 to/bis +130/140	-10 to/bis +130/140
Insulating class / Isolationsklasse		F	F	F
Casing type / Werkstoffe		GG / Cast iron	GG / Cast iron	GG / Cast iron
Duble pump / Zwillingpumpe		no / nein	no / nein	yes / ja
APPLICATIONS / EINSATZGEBIETE				
Heating / Warmwasserheizungen		✓	✓	✓
Cooling / Kaltwasseranlagen		✓	✓	✓
Sanitary water / Brauchwasser				
Climate appliances / Klimaanlage		✓	✓	✓
Industry / Industrieanlagen				
Process technique / Verfahrenstechnik				
Condensation / Kondensat		✓	✓	✓
Salt water / Meerwasser				

Pump markings / Typenschlüssel

CV	32	- 4	/	60	impeller size / Laufrad	
					number of electromotor poles / polig	
					connection size / nennweite DN	
					pump type / pumpentyp	
CL / CLD	40	1 (2,3)	- 2	/	5,5	power W x 100 / Leistungsaufnahme W x 100
						number of electromotor poles / polig
						impeller size / Laufrad
						connection size / nennweite DN
						pump type-single (CL), twin (CLD) / pumpentyp, einzelne (CL), zwillingsbauform (CLD)
CL / CLD	40	- 90	1 (2)	- 2 (4)		number of electromotor poles / polig
						motor type / Motortyp
						system pressure / systemdruck
						connection size / nennweite DN
						pump type-single (CL), twin (CLD) / pumpentyp, einzelne (CL), zwillingsbauform (CLD)

Permitted mounting positions / Einbaumöglichkeiten

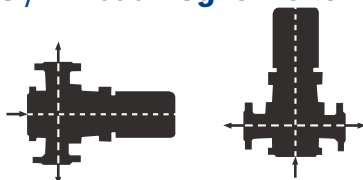

Standard in-line pumps Standard - Inline Pumpen

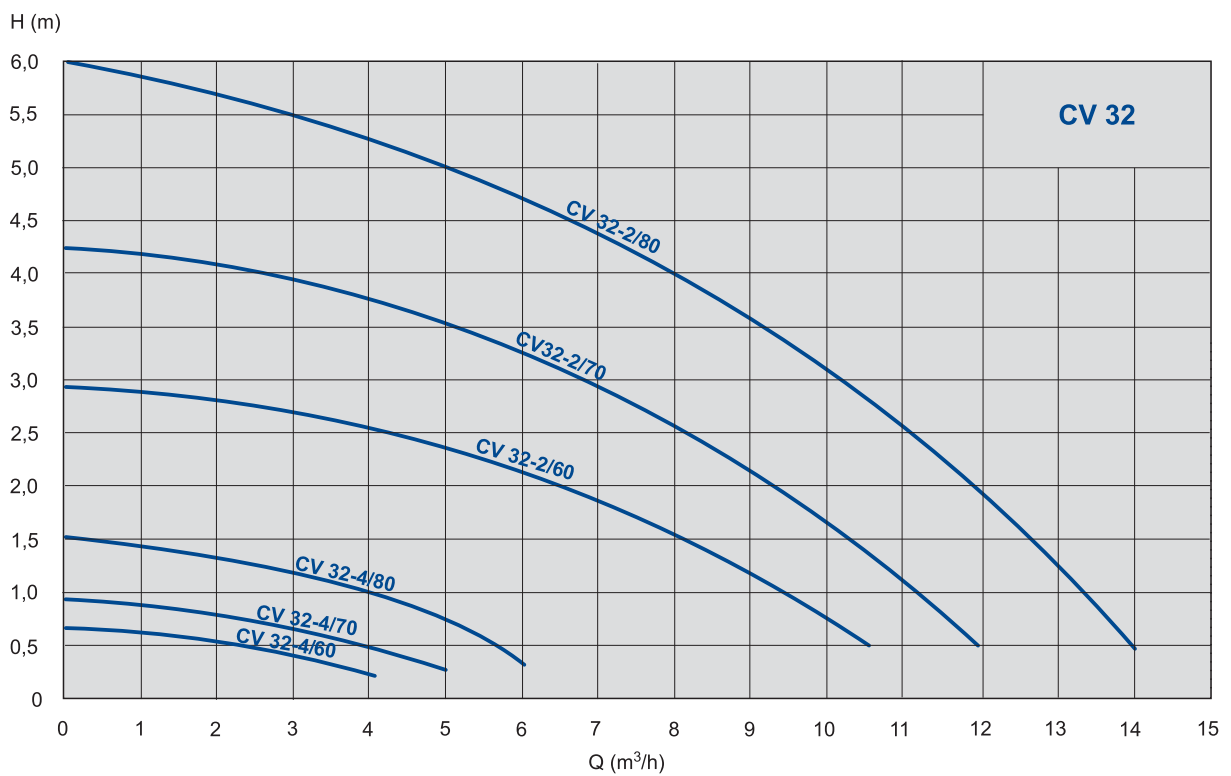
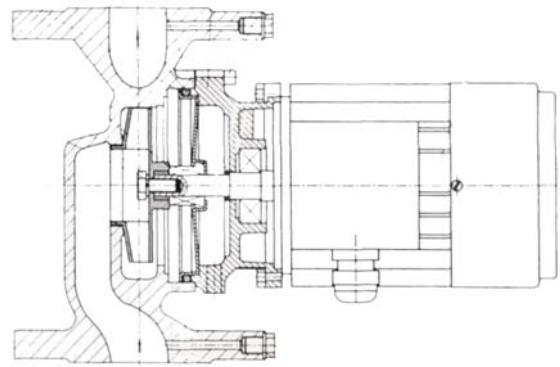
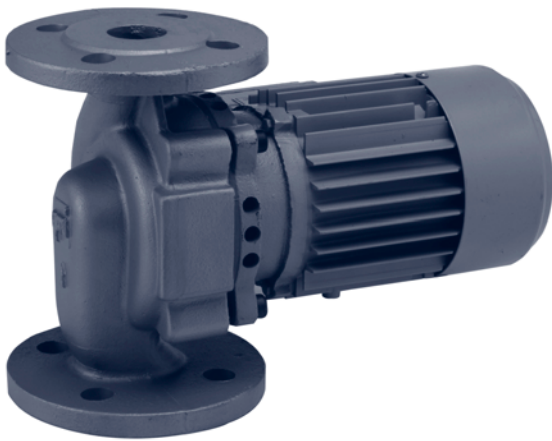

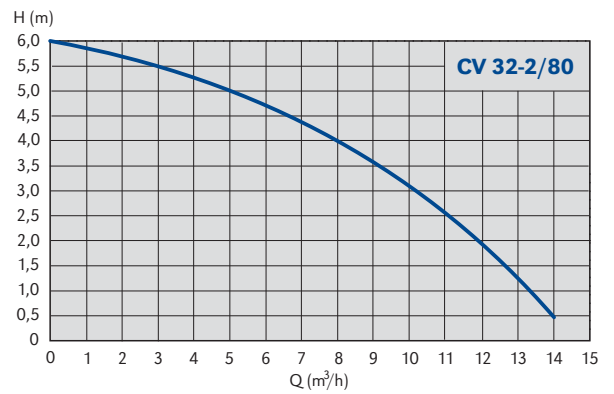
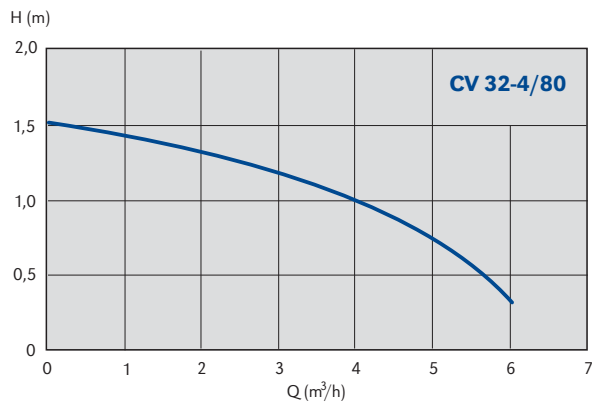
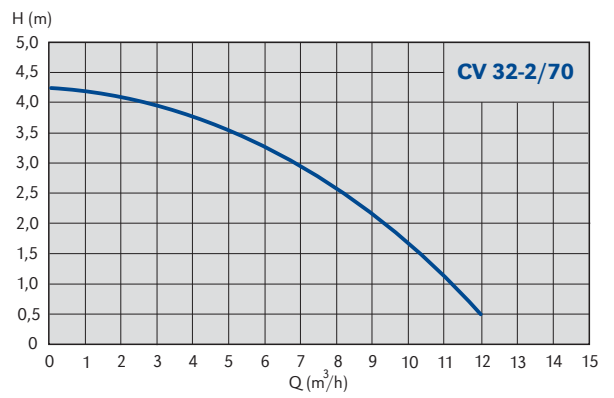
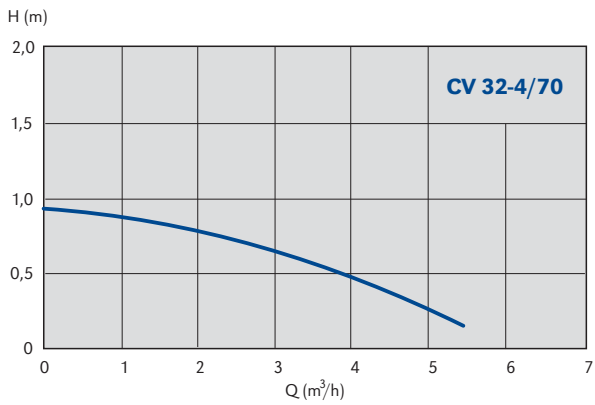
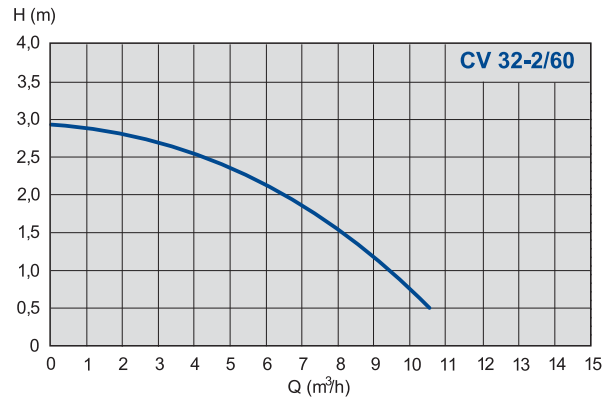
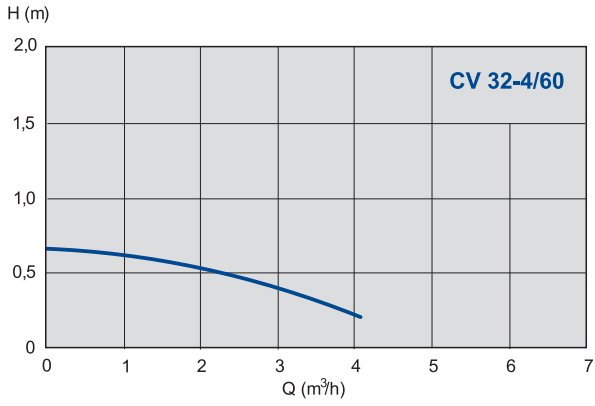

Standard in-line pumps
Standard - Inline Pumpen

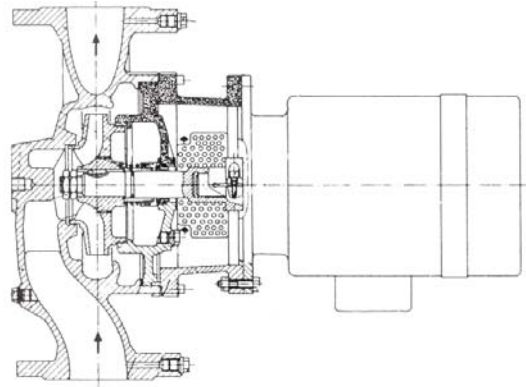

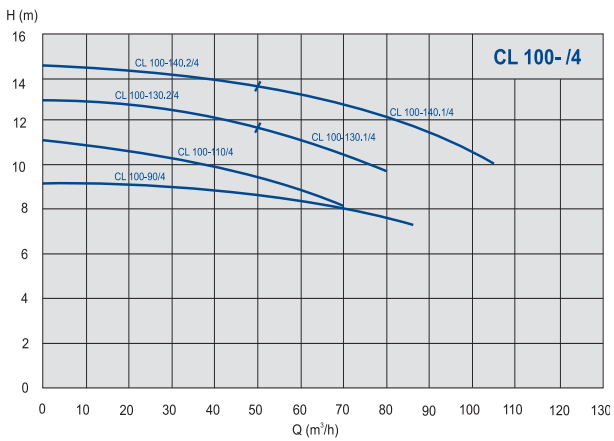
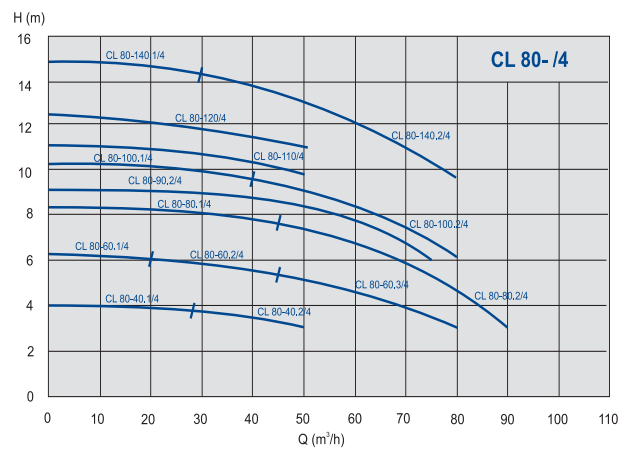
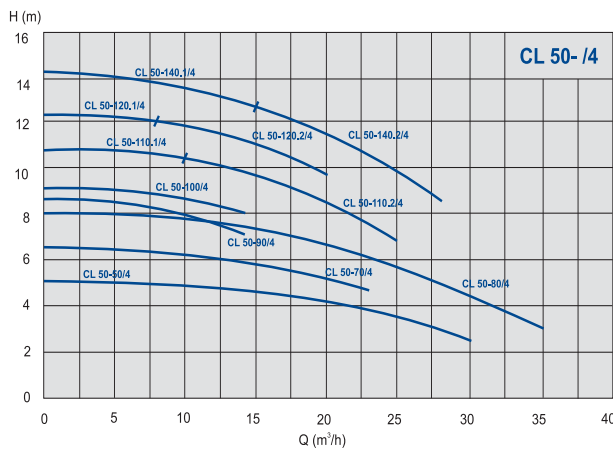
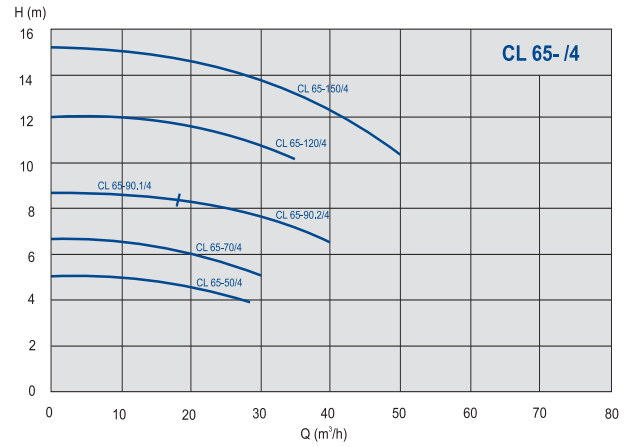
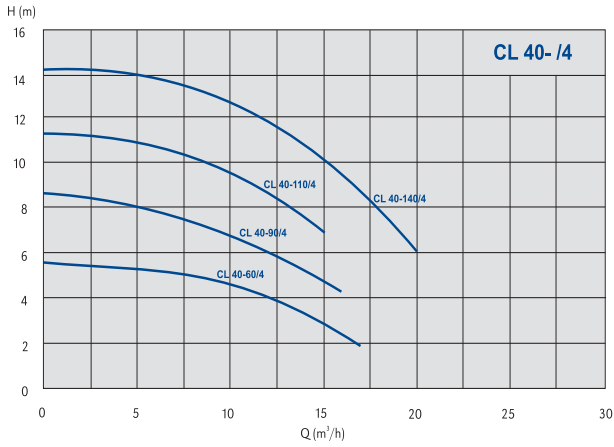

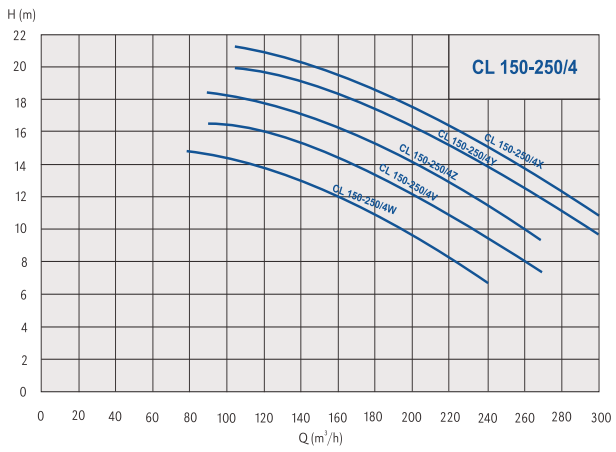
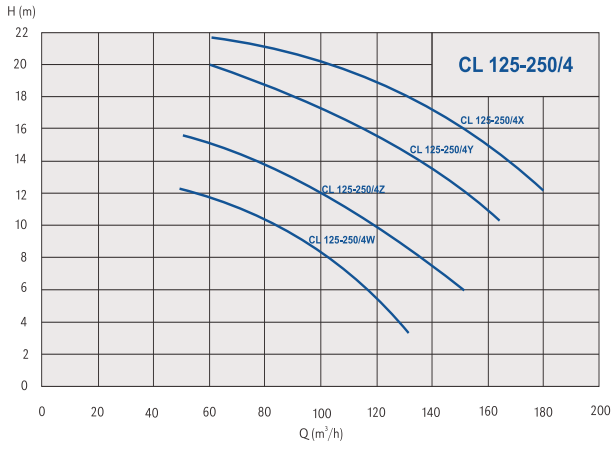
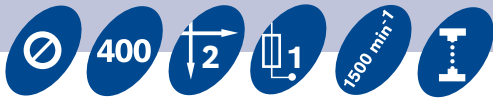

Standard in-line pumps
Standard - Inline Pumpen

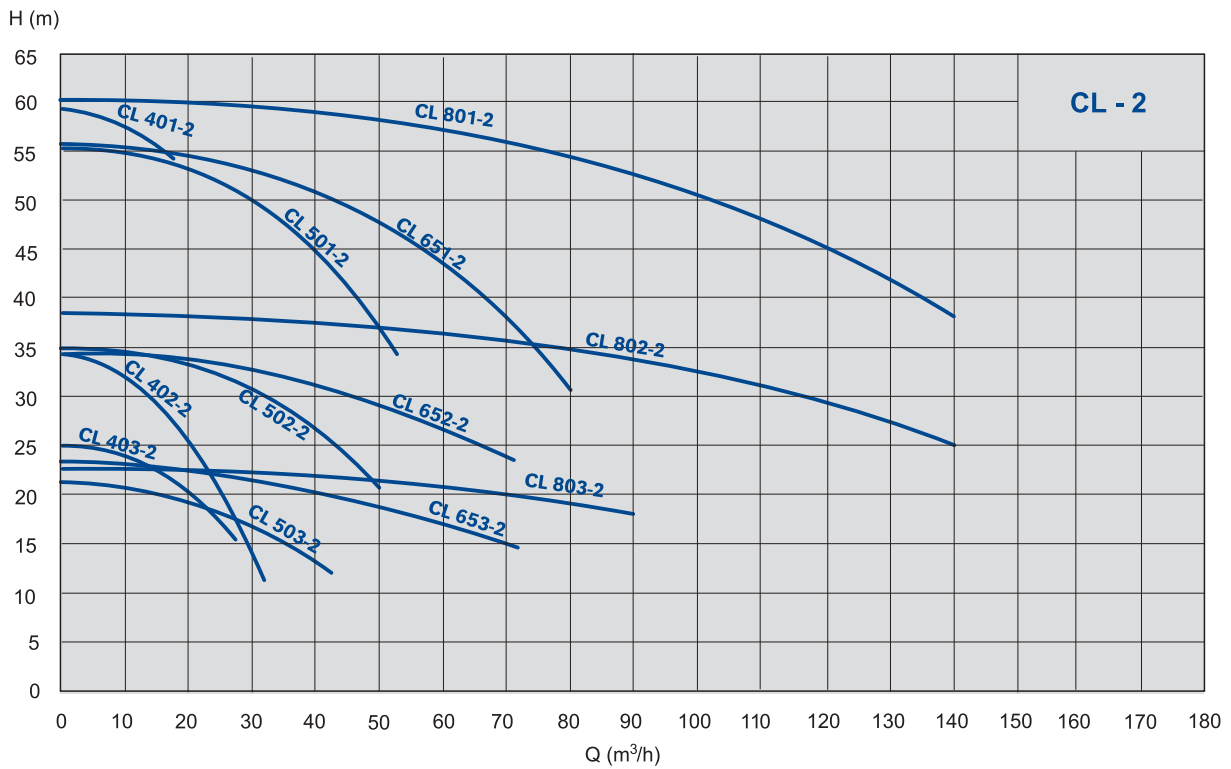
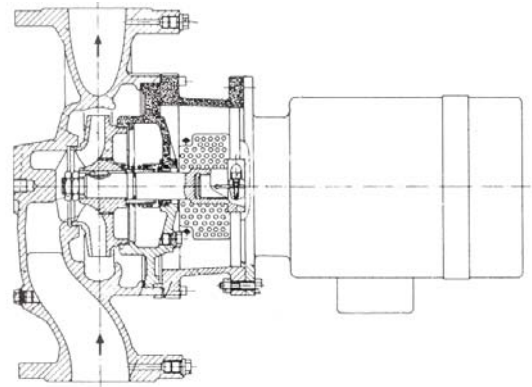
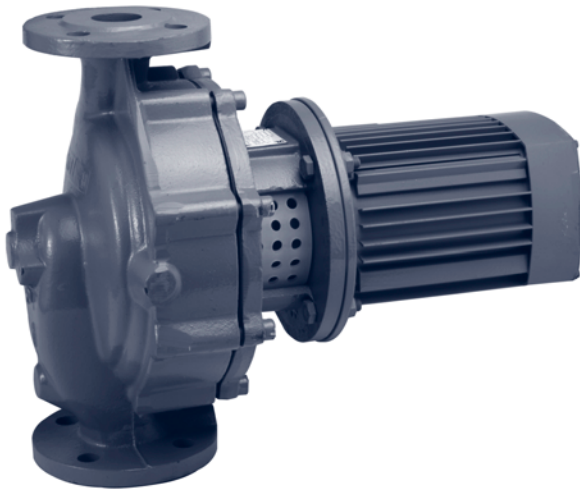

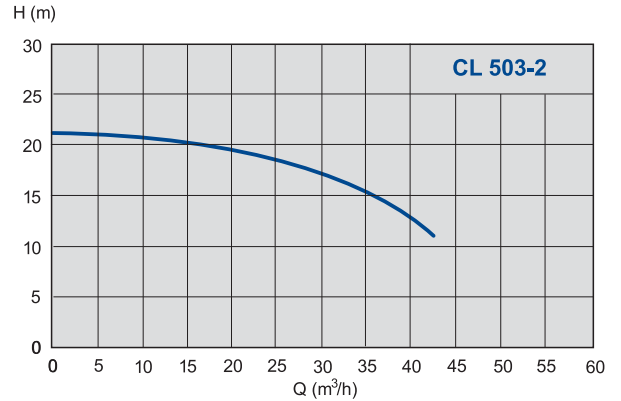
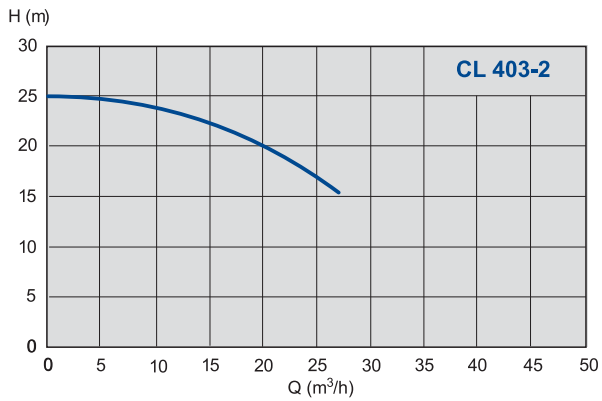
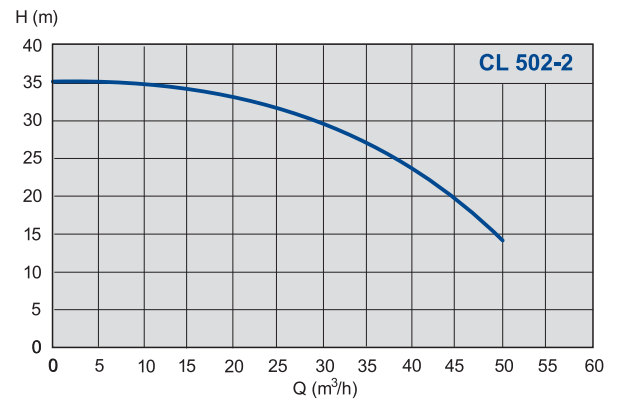
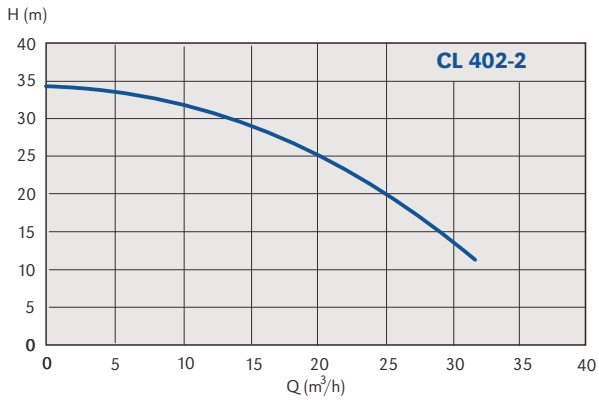
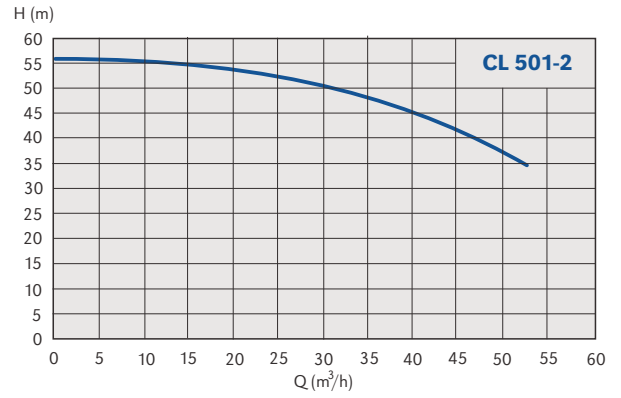
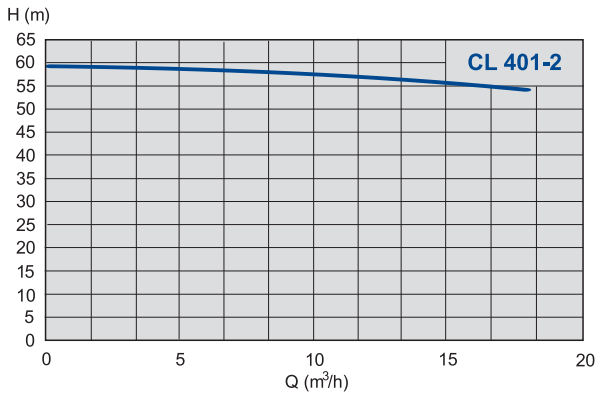
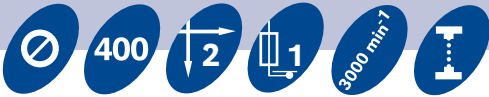

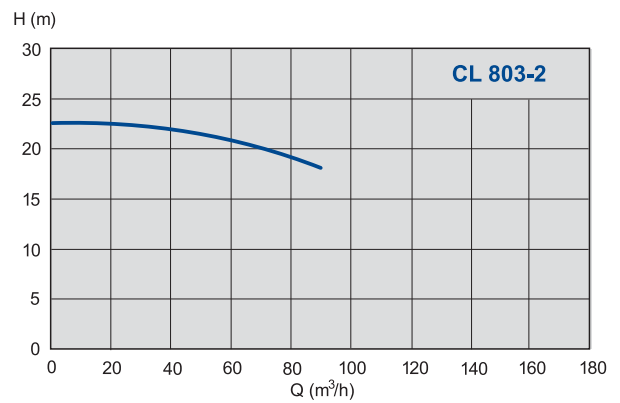
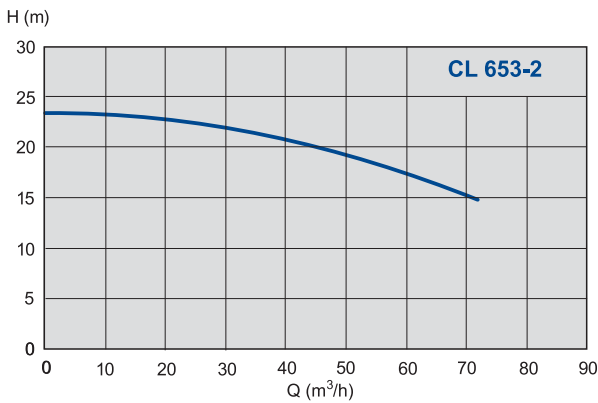
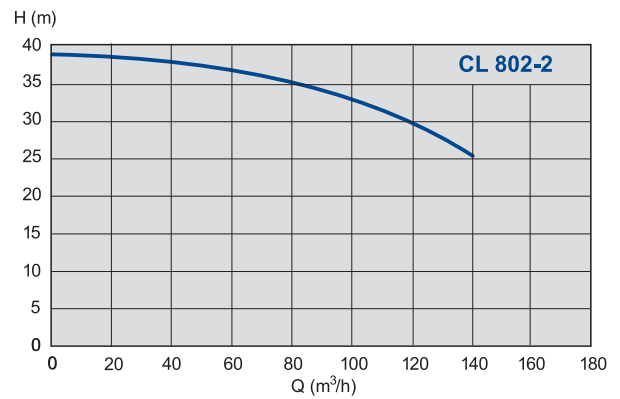
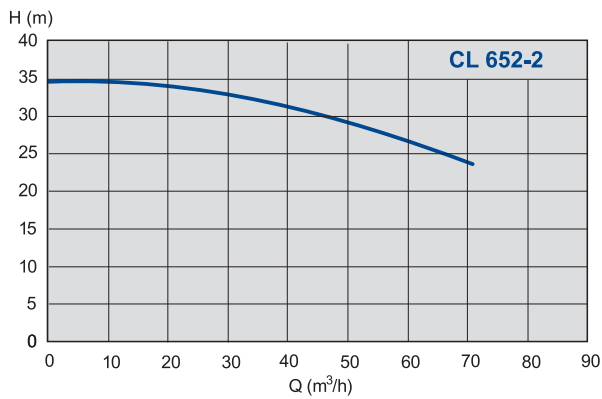
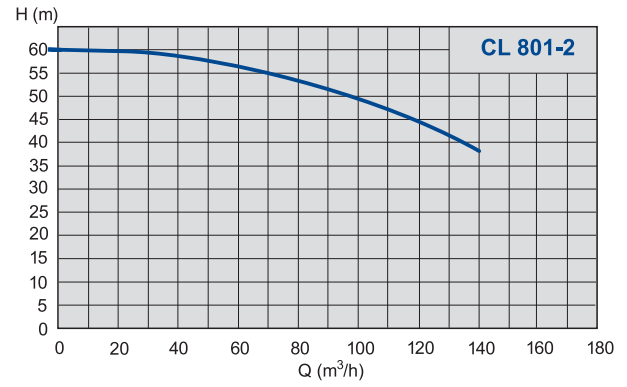
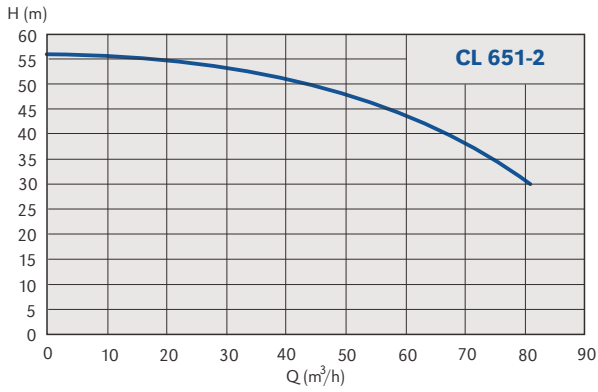
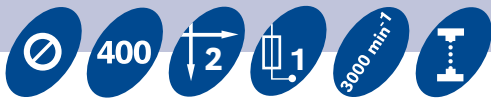

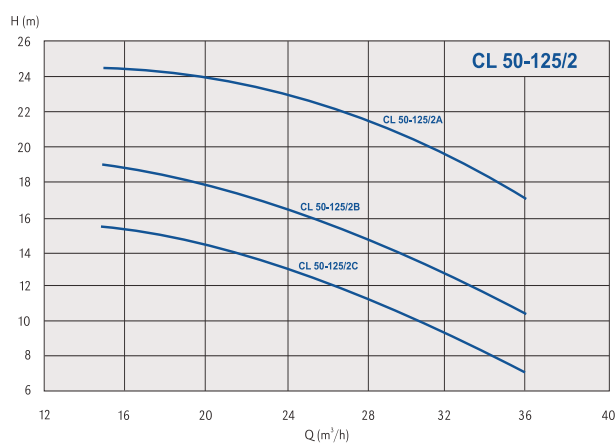
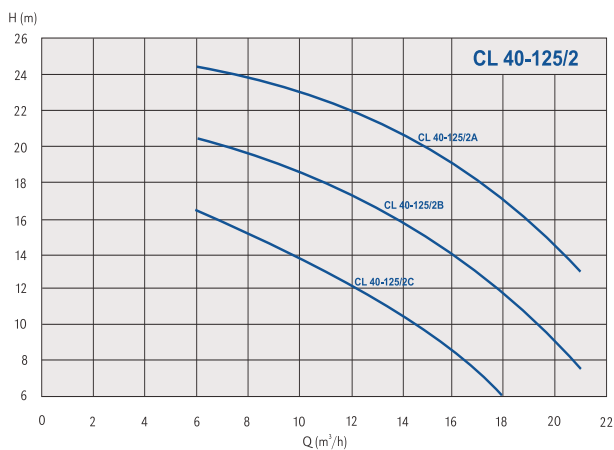
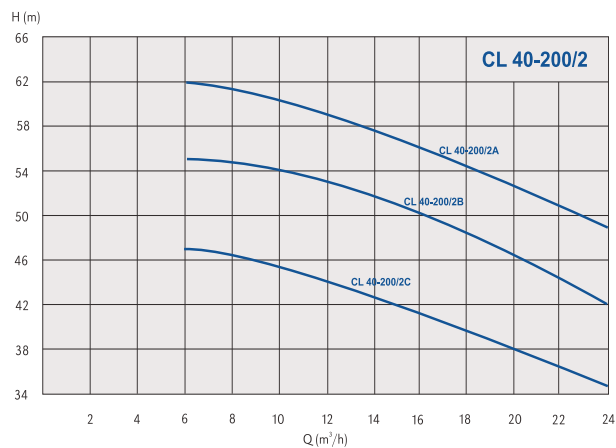
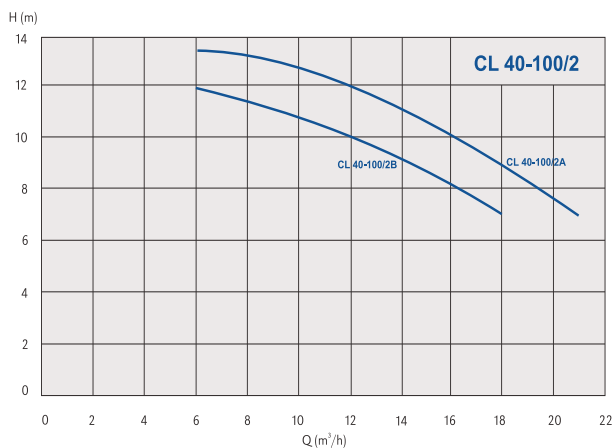
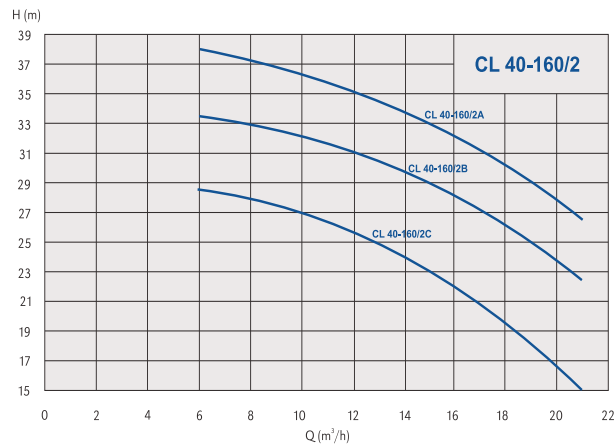
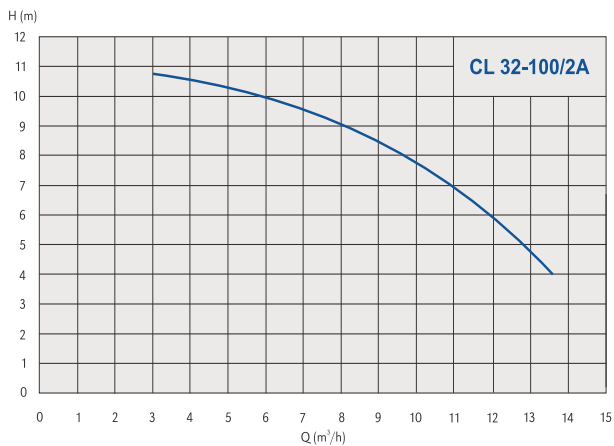

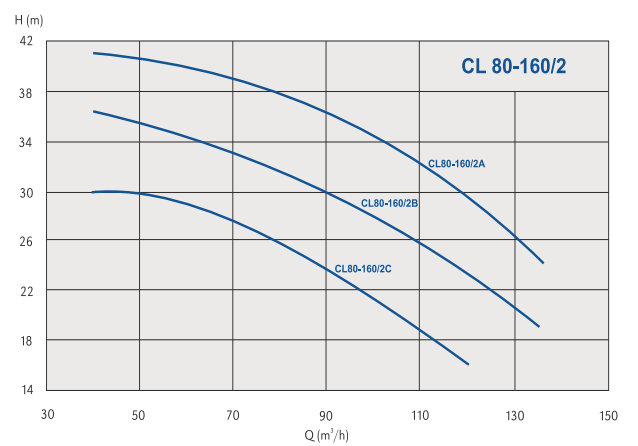
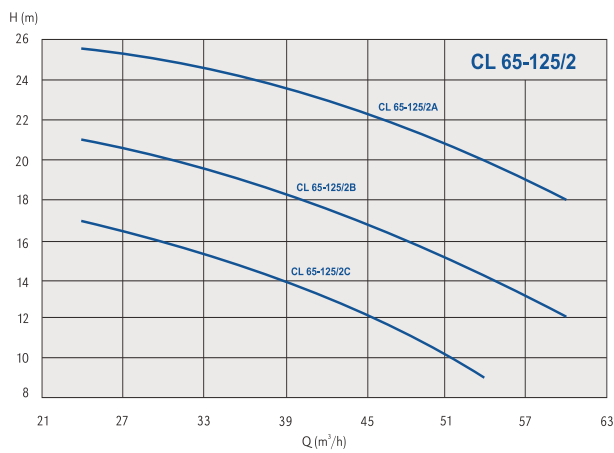
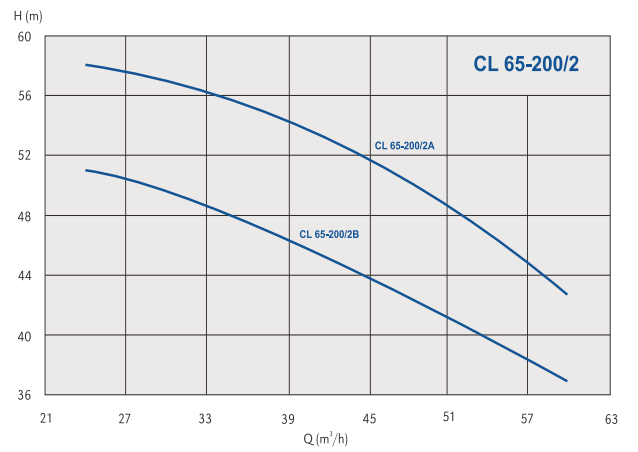
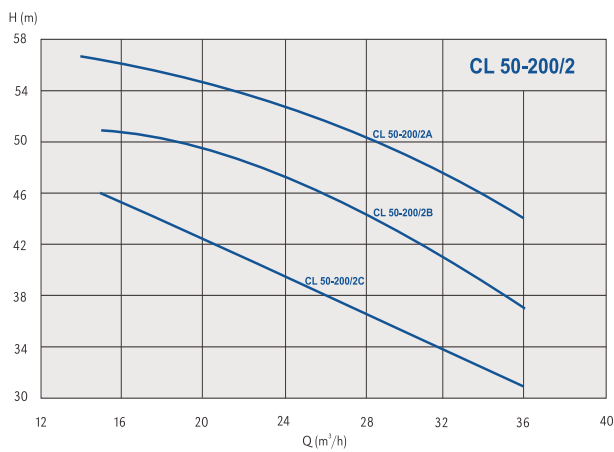
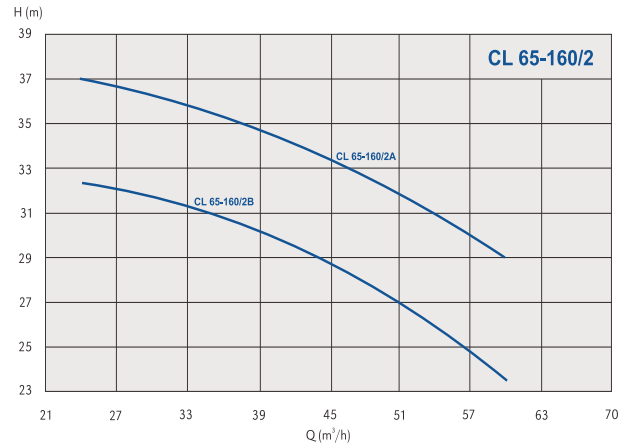
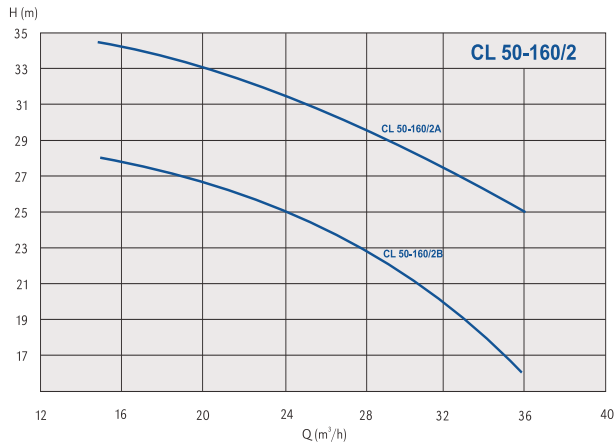
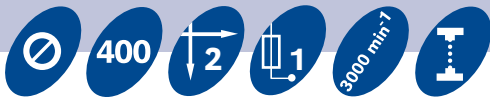

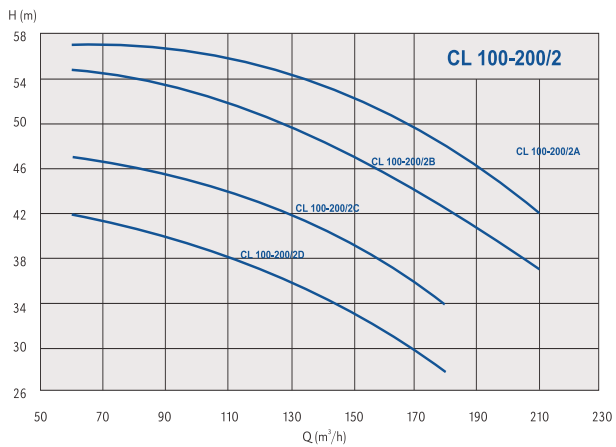
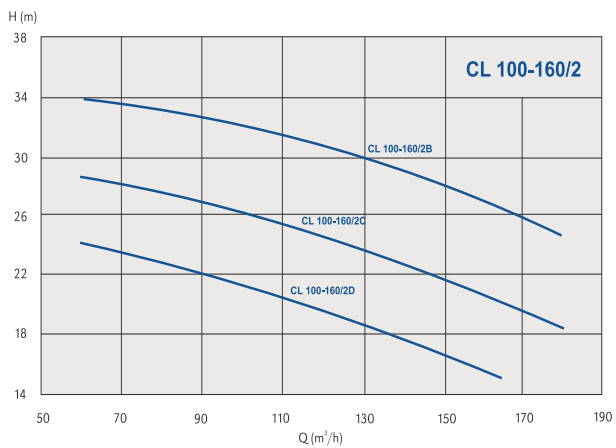
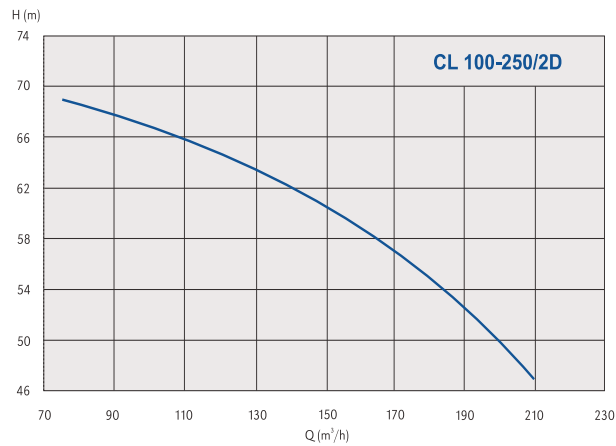
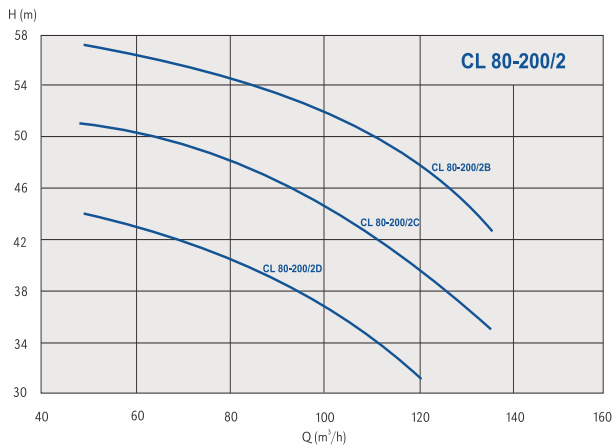

Standard double in-line pumps
Standard - Inline Pumpen - Doppelauslegung

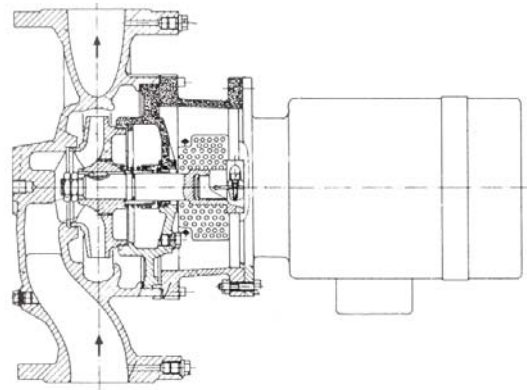
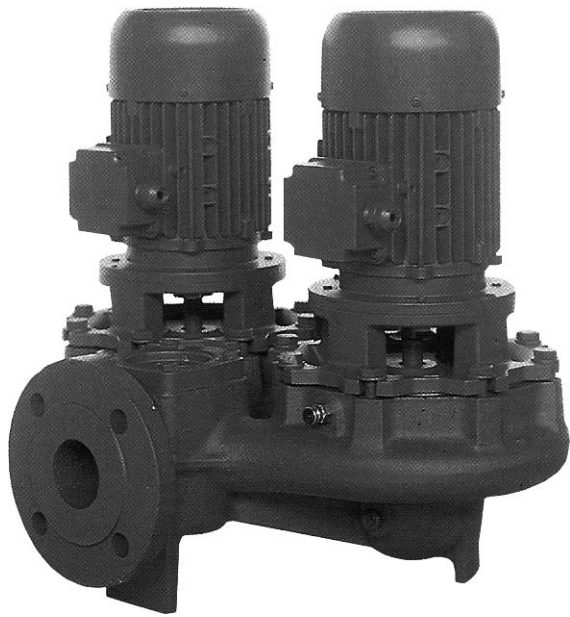

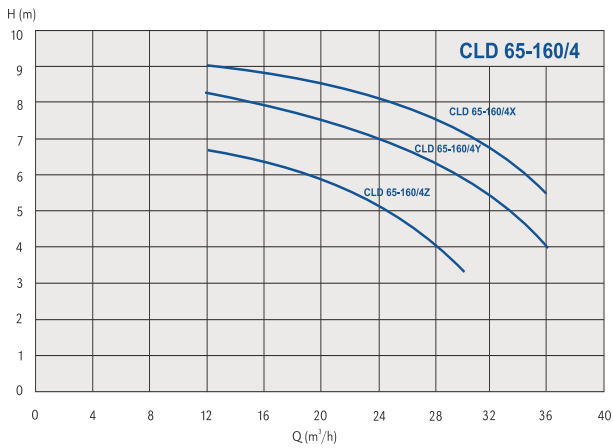
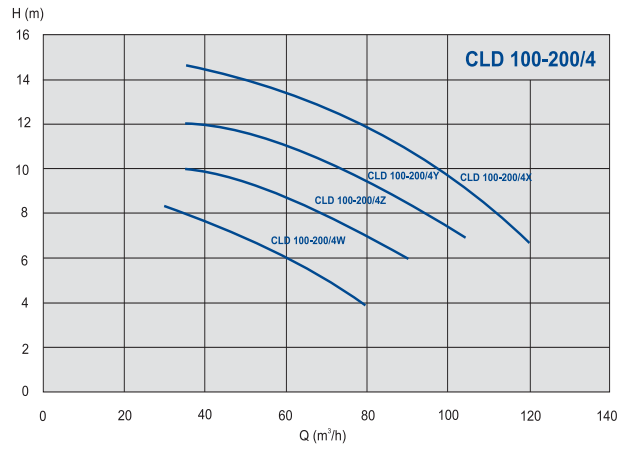
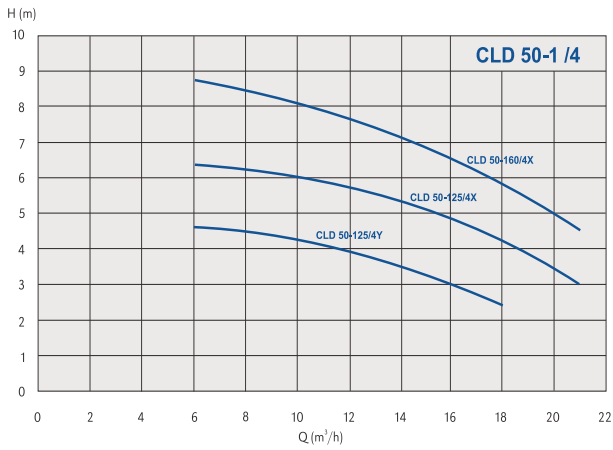
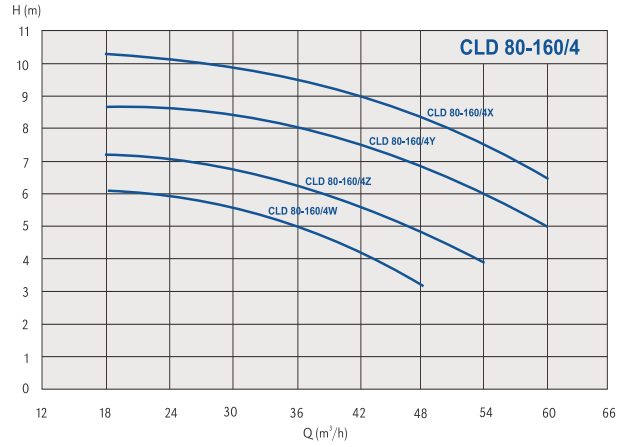
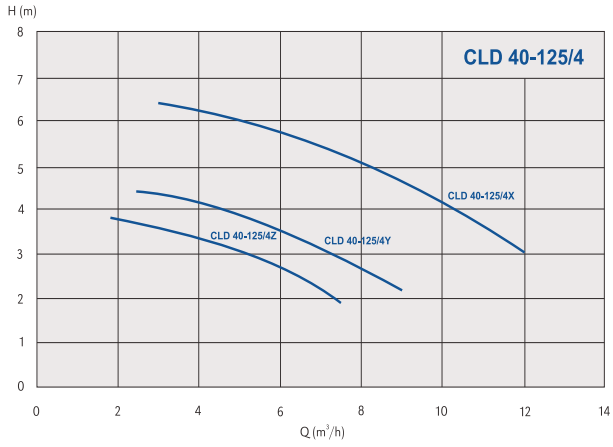

Standard double in-line pumps
Standard - Inline Pumpen - Doppelauslegung

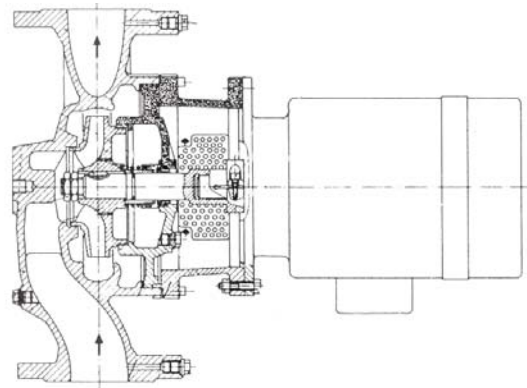
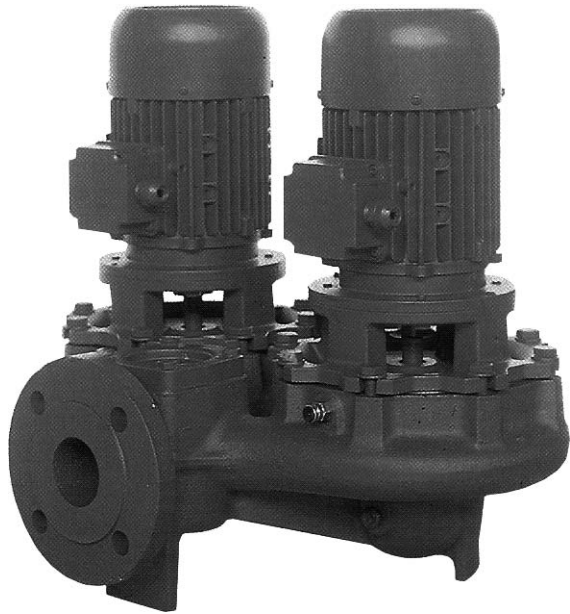

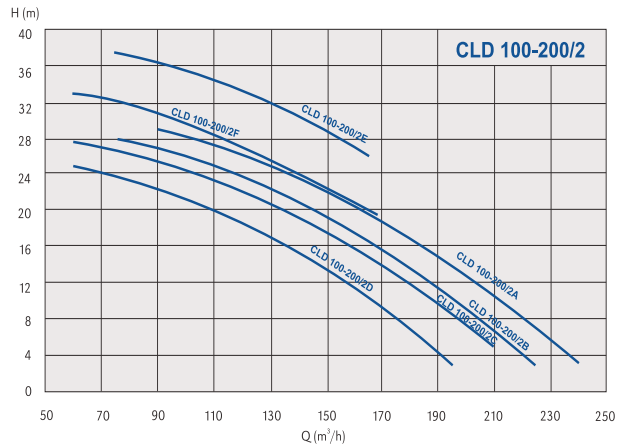
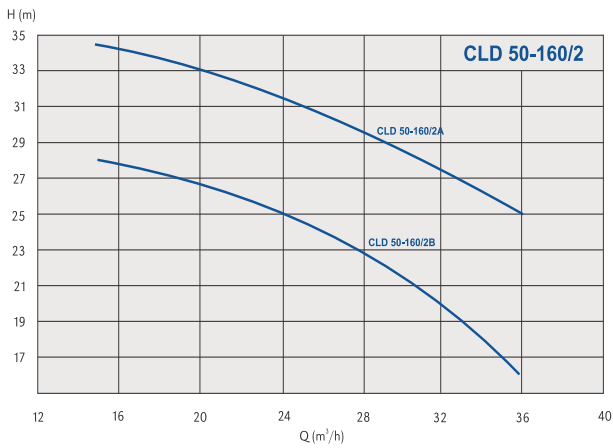
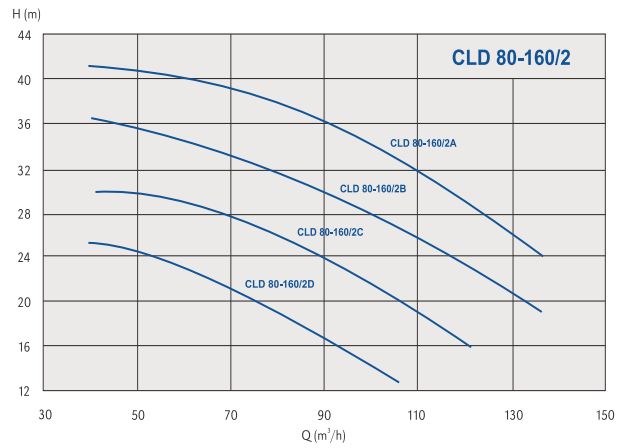
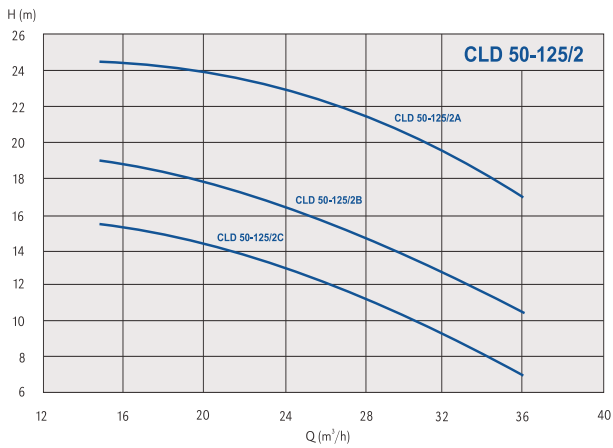
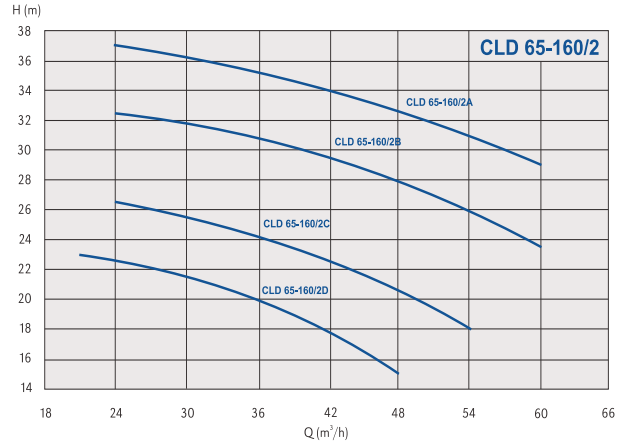
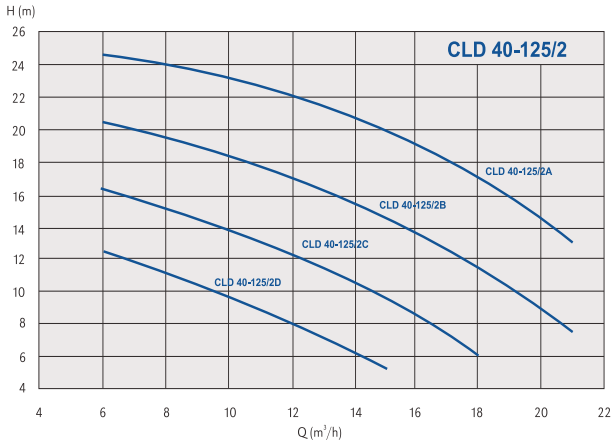

TEHNICAL DATA / TECHNISCHE DATEN

pump type pumpentyp	code artikelnummer	connection size rohranschluss DN (")	connection type rohranschluss	max. flow durchfluss Q (m ³ /h)	max. pressure druck H (m)	system pressure systemdruck PN (bar)	min. media temp. des medius T min. °C	max. media temp. des medius T max. °C	casing type werkstoffe GG / Cast iron	single-S, double-D einzelne-E, zwillings- bauform-Z	net weight Rein- gewicht (kg)	regulation geregelt yes /ja no /nein	degree of protection schutzart IP
CV 32 - 4 / 60	979521532	DN 32	flanges/flansche	4	0,6	PN 16	-10	110	GG/CI	S/E	15	no/nein	54
CV 32 - 4 / 70	979521531	DN 32	flanges/flansche	5	0,9	PN 16	-10	110	GG/CI	S/E	15	no/nein	54
CV 32 - 4 / 80	979521530	DN 32	flanges/flansche	7	1,5	PN 16	-10	110	GG/CI	S/E	15	no/nein	54
CV 32 - 2 / 60	979521529	DN 32	flanges/flansche	8	3	PN 16	-10	110	GG/CI	S/E	15	no/nein	54
CV 32 - 2 / 70	979521528	DN 32	flanges/flansche	9,5	4	PN 16	-10	110	GG/CI	S/E	15	no/nein	54
CV 32 - 2 / 80	979521527	DN 32	flanges/flansche	13	6	PN 16	-10	110	GG/CI	S/E	15	no/nein	54

TEHNIICAL DATA / TECHNISCHE DATEN

pump type pumpentyp	code artikelnummer	connection size rohranschluss DN (")	connection type rohranschluss	max. flow durchfluss Q (m ³ /h)	max. pressure druck H (m)	system pressure systemdruck PN (bar)	min. media temp. des medius T min. °C	max. media temp. des medius T max. °C	casing type werkstoffe GG/ Cast iron	single-S, double-D einzelne-E, zwillings- bauform-Z	net weight Reinge- wicht (kg)	regulation geregelt yes / ja no / nein	degree of protection schutzart IP
CL 40-140/4	979522775	DN 40	flanges/flansche	20	14	PN 16	-10	140	GG/CI	S/E	45	optional	55
CL 40-110/4	979521582	DN 40	flanges/flansche	15	11	PN 16	-10	140	GG/CI	S/E	41	optional	55
CL 40-90/4	979522606	DN 40	flanges/flansche	16	9	PN 16	-10	140	GG/CI	S/E	39	optional	55
CL 40-60/4	979522774	DN 40	flanges/flansche	17	6	PN 16	-10	140	GG/CI	S/E	22	optional	55
CL 50-140.1/4	979521584	DN 50	flanges/flansche	15	14	PN 16	-10	140	GG/CI	S/E	44	optional	55
CL 50-140.2/4	979522778	DN 50	flanges/flansche	28	14	PN 16	-10	140	GG/CI	S/E	47	optional	55
CL 50-120.1/4	979521586	DN 50	flanges/flansche	8	12	PN 16	-10	140	GG/CI	S/E	40	optional	55
CL 50-120.2/4	979521585	DN 50	flanges/flansche	20	12	PN 16	-10	140	GG/CI	S/E	44	optional	55
CL 50-110.1/4	979521588	DN 50	flanges/flansche	10	11	PN 16	-10	140	GG/CI	S/E	47,5	optional	55
CL 50-110.2/4	979521587	DN 50	flanges/flansche	25	11	PN 16	-10	140	GG/CI	S/E	44	optional	55
CL 50-100/4	979521589	DN 50	flanges/flansche	14	10	PN 16	-10	140	GG/CI	S/E	40	optional	55
CL 50-90/4	979521590	DN 50	flanges/flansche	14	9	PN 16	-10	140	GG/CI	S/E	39	optional	55
CL 50-80/4	979522777	DN 50	flanges/flansche	35	8	PN 16	-10	140	GG/CI	S/E	44	optional	55
CL 50-70/4	979521591	DN 50	flanges/flansche	23	7	PN 16	-10	140	GG/CI	S/E	39	optional	55
CL 50-50/4	979522776	DN 50	flanges/flansche	30	5	PN 16	-10	140	GG/CI	S/E	42	optional	55
CL 65-150/4	979522780	DN 65	flanges/flansche	50	15	PN 16	-10	140	GG/CI	S/E	60	optional	55
CL 65-120/4	979522773	DN 65	flanges/flansche	35	12	PN 16	-10	140	GG/CI	S/E	55	optional	55
CL 65-90.1/4	979522772	DN 65	flanges/flansche	18	9	PN 16	-10	140	GG/CI	S/E	44	optional	55
CL 65-90.2/4	979522779	DN 65	flanges/flansche	40	9	PN 16	-10	140	GG/CI	S/E	48	optional	55
CL 65-70/4	979521617	DN 65	flanges/flansche	30	7	PN 16	-10	140	GG/CI	S/E	44	optional	55
CL 65-50/4	979522771	DN 65	flanges/flansche	28	5	PN 16	-10	140	GG/CI	S/E	39	optional	55
CL 80-140.1/4	979521594	DN 80	flanges/flansche	30	14	PN 16	-10	140	GG/CI	S/E	72	optional	55
CL 80-140.2/4	979522783	DN 80	flanges/flansche	80	14	PN 16	-10	140	GG/CI	S/E	79,5	optional	55
CL 80-120/4	979522770	DN 80	flanges/flansche	51	12	PN 16	-10	140	GG/CI	S/E	72	optional	55
CL 80-110/4	979521595	DN 80	flanges/flansche	50	11	PN 16	-10	140	GG/CI	S/E	72	optional	55
CL 80-100.1/4	979522768	DN 80	flanges/flansche	40	10	PN 16	-10	140	GG/CI	S/E	67	optional	55
CL 80-100.2/4	979522769	DN 80	flanges/flansche	80	10	PN 16	-10	140	GG/CI	S/E	72	optional	55
CL 80-90/4	979522782	DN 80	flanges/flansche	75	9	PN 16	-10	140	GG/CI	S/E	66	optional	55
CL 80-80.1/4	979522766	DN 80	flanges/flansche	45	8	PN 16	-10	140	GG/CI	S/E	61	optional	55
CL 80-80.2/4	979522767	DN 80	flanges/flansche	90	8	PN 16	-10	140	GG/CI	S/E	66	optional	55
CL 80-60.1/4	979521596	DN 80	flanges/flansche	20	6	PN 16	-10	140	GG/CI	S/E	47	optional	55
CL 80-60.2/4	979522781	DN 80	flanges/flansche	45	6	PN 16	-10	140	GG/CI	S/E	51	optional	55
CL 80-60.3/4	979522765	DN 80	flanges/flansche	80	6	PN 16	-10	140	GG/CI	S/E	53	optional	55
CL 80-40.1/4	979521599	DN 80	flanges/flansche	28	4	PN 16	-10	140	GG/CI	S/E	46	optional	55
CL 80-40.2/4	979522764	DN 80	flanges/flansche	50	4	PN 16	-10	140	GG/CI	S/E	47	optional	55
CL 100-140.1/4	979521600	DN 100	flanges/flansche	50	14	PN 16	-10	140	GG/CI	S/E	74	optional	55
CL 100-140.2/4	979522785	DN 100	flanges/flansche	105	14	PN 16	-10	140	GG/CI	S/E	80	optional	55
CL 100-130.1/4	979521602	DN 100	flanges/flansche	50	13	PN 16	-10	140	GG/CI	S/E	72	optional	55
CL 100-130.2/4	979521601	DN 100	flanges/flansche	80	13	PN 16	-10	140	GG/CI	S/E	74	optional	55
CL 100-110/4	979521603	DN 100	flanges/flansche	70	11	PN 16	-10	140	GG/CI	S/E	72	optional	55
CL 100-90/4	979522784	DN 100	flanges/flansche	86	9	PN 16	-10	140	GG/CI	S/E	79	optional	55
CL 125-250/4W		DN 125	flanges/flansche	130	13	PN 16	-10	130	GG/CI	S/E	132	optional	55
CL 125-250/4Z		DN 125	flanges/flansche	150	16	PN 16	-10	130	GG/CI	S/E	132	optional	55
CL 125-250/4Y		DN 125	flanges/flansche	170	21	PN 16	-10	130	GG/CI	S/E	135	optional	55
CL 125-250/4X		DN 125	flanges/flansche	180	22	PN 16	-10	130	GG/CI	S/E	136	optional	55
CL 150-250/4W		DN 150	flanges/flansche	250	15	PN 16	-10	130	GG/CI	S/E	154	optional	55
CL 150-250/4V		DN 150	flanges/flansche	270	16,5	PN 16	-10	130	GG/CI	S/E	158	optional	55
CL 150-250/4Z		DN 150	flanges/flansche	280	18,5	PN 16	-10	130	GG/CI	S/E	162	optional	55
CL 150-250/4Y		DN 150	flanges/flansche	300	20	PN 16	-10	130	GG/CI	S/E	201	optional	55
CL 150-250/4		DN 150	flanges/flansche	310	21,5	PN 16	-10	130	GG/CI	S/E	201	optional	55

TECHNICAL DATA / TECHNISCHE DATEN

pump type pumpentyp	code artikelnummer	connection size rohranschluss DN (")	connection type rohranschluss	max. flow durchfluss Q (m ³ /h)	max. pressure druck H (m)	system pressure systemdruck PN (bar)	min. media temp. des medius T min. °C	max. media temp. des medius T max. °C	casing type werkstoffe GG / Cast iron	single-S, double-D einzelne-E, zwillings- bauform-Z	net weight Rein- gewicht (kg)	regulation geregelt yes / ja no / nein	degree of protection schutzart IP
CL 401 - 2	979520867	DN 40	flanges/flansche	18	57	PN 16	-15	140	GG/CI	S/E	76	optional	54
CL 402 - 2	979520868	DN 40	flanges/flansche	32	32	PN 16	-15	140	GG/CI	S/E	70	optional	54
CL 403 - 2	979520869	DN 40	flanges/flansche	27	26	PN 16	-15	140	GG/CI	S/E	38	optional	54
CL 501 - 2	979520870	DN 50	flanges/flansche	54	57	PN 16	-15	140	GG/CI	S/E	130	optional	54
CL 502 - 2	979520871	DN 50	flanges/flansche	50	32	PN 16	-15	140	GG/CI	S/E	70	optional	54
CL 503 - 2	979520872	DN 50	flanges/flansche	43	21	PN 16	-15	140	GG/CI	S/E	66	optional	54
CL 651 - 2	979520873	DN 65	flanges/flansche	80	57	PN 16	-15	140	GG/CI	S/E	157	optional	54
CL 652 - 2	979520874	DN 65	flanges/flansche	72	34	PN 16	-15	140	GG/CI	S/E	99	optional	54
CL 653 - 2	979520875	DN 65	flanges/flansche	72	24	PN 16	-15	140	GG/CI	S/E	76	optional	54
CL 801 - 2	979520876	DN 80	flanges/flansche	140	60	PN 16	-15	140	GG/CI	S/E	210	optional	54
CL 802 - 2	979520877	DN 80	flanges/flansche	140	38	PN 16	-15	140	GG/CI	S/E	175	optional	54
CL 803 - 2	979520878	DN 80	flanges/flansche	90	22	PN 16	-15	140	GG/CI	S/E	103	optional	54
CL 32-100/2A		DN 32	flanges/flansche	14	11	PN 16	-10	130			12	optional	55
CL 40-100/2B		DN 40	flanges/flansche	18	12	PN 16	-10	130	GG/CI	S/E	16	optional	55
CL 40-100/2A		DN 40	flanges/flansche	21	13,5	PN 16	-10	130	GG/CI	S/E	16	optional	55
CL 40-125/2C		DN 40	flanges/flansche	18	17	PN 16	-10	130	GG/CI	S/E	24	optional	55
CL 40-125/2B		DN 40	flanges/flansche	21	21	PN 16	-10	130	GG/CI	S/E	25	optional	55
CL 40-125/2A		DN 40	flanges/flansche	23	24,5	PN 16	-10	130	GG/CI	S/E	26	optional	55
CL 40-160/2C		DN 40	flanges/flansche	21	28,5	PN 16	-10	130	GG/CI	S/E	30	optional	55
CL 40-160/2B		DN 40	flanges/flansche	22	33,5	PN 16	-10	130	GG/CI	S/E	35	optional	55
CL 40-160/2A		DN 40	flanges/flansche	23	38	PN 16	-10	130	GG/CI	S/E	37	optional	55
CL 40-200/2C		DN 40	flanges/flansche	24	47	PN 16	-10	130	GG/CI	S/E	50	optional	55
CL 40-200/2B		DN 40	flanges/flansche	28	55	PN 16	-10	130	GG/CI	S/E	50	optional	55
CL 40-200/2A		DN 40	flanges/flansche	32	62	PN 16	-10	130	GG/CI	S/E	50	optional	55
CL 50-125/2C		DN 50	flanges/flansche	36	15,5	PN 16	-10	130	GG/CI	S/E	27	optional	55
CL 50-125/2B		DN 50	flanges/flansche	39	19	PN 16	-10	130	GG/CI	S/E	28	optional	55
CL 50-125/2A		DN 50	flanges/flansche	42	24,5	PN 16	-10	130	GG/CI	S/E	32	optional	55
CL 50-160/2B		DN 50	flanges/flansche	35	28	PN 16	-10	130	GG/CI	S/E	32	optional	55
CL 50-160/2A		DN 50	flanges/flansche	42	35	PN 16	-10	130	GG/CI	S/E	42	optional	55
CL 50-200/2C		DN 50	flanges/flansche	36	46	PN 16	-10	130	GG/CI	S/E	56	optional	55
CL 50-200/2B		DN 50	flanges/flansche	40	51	PN 16	-10	130	GG/CI	S/E	57	optional	55
CL 50-200/2A		DN 50	flanges/flansche	42	57	PN 16	-10	130	GG/CI	S/E	64	optional	55
CL 65-125/2C		DN 65	flanges/flansche	52	17	PN 16	-10	130	GG/CI	S/E	35	optional	55
CL 65-125/2B		DN 65	flanges/flansche	60	21	PN 16	-10	130	GG/CI	S/E	39	optional	55
CL 65-125/2A		DN 65	flanges/flansche	68	25,5	PN 16	-10	130	GG/CI	S/E	43	optional	55
CL 65-160/2B		DN 65	flanges/flansche	58	32	PN 16	-10	130	GG/CI	S/E	54	optional	55
CL 65-160/2A		DN 65	flanges/flansche	70	37	PN 16	-10	130	GG/CI	S/E	61	optional	55
CL 65-200/2B		DN 65	flanges/flansche	58	51	PN 16	-10	130	GG/CI	S/E	70	optional	55
CL 65-200/2A		DN 65	flanges/flansche	63	58	PN 16	-10	130	GG/CI	S/E	77	optional	55
CL 80-160/2C		DN 80	flanges/flansche	120	30	PN 16	-10	130	GG/CI	S/E	72	optional	55
CL 80-160/2B		DN 80	flanges/flansche	140	37	PN 16	-10	130	GG/CI	S/E	79	optional	55
CL 80-160/2A		DN 80	flanges/flansche	150	41	PN 16	-10	130	GG/CI	S/E	85	optional	55
CL 80-200/2D		DN 80	flanges/flansche	120	44	PN 16	-10	130	GG/CI	S/E	91	optional	55
CL 80-200/2C		DN 80	flanges/flansche	140	51	PN 16	-10	130	GG/CI	S/E	124	optional	55
CL 80-200/2B		DN 80	flanges/flansche	150	57	PN 16	-10	130	GG/CI	S/E	142	optional	55
CL 100-160/2D		DN 100	flanges/flansche	160	24	PN 16	-10	130	GG/CI	S/E	76	optional	55
CL 100-160/2C		DN 100	flanges/flansche	180	29	PN 16	-10	130	GG/CI	S/E	84	optional	55
CL 100-160/2B		DN 100	flanges/flansche	210	34	PN 16	-10	130	GG/CI	S/E	91	optional	55

TEHNICAL DATA / TECHNISCHE DATEN

pump type pumpentyp	code artikelnummer	connection size rohranschluss DN (")	connection type rohranschluss	max. flow durchfluss Q (m ³ /h)	max. pressure druck H (m)	system pressure systemdruck PN (bar)	min. media temp. des mediums T min. °C	max. media temp. des mediums T max. °C	casing type werkstoffe GG / Cast iron	single-S, double-D, einzelne-E, zwillings- bauform-Z	net Reinge- wicht (kg)	regulation geregelt yes / ja no / nein	degree of protection schutzart IP
CL 100-200/2D		DN 100	flanges/flansche	180	42	PN 16	-10	130	GG/CI	S/E	153	optional	55
CL 100-200/2C		DN 100	flanges/flansche	190	47	PN 16	-10	130	GG/CI	S/E	195	optional	55
CL 100-200/2B		DN 100	flanges/flansche	220	55	PN 16	-10	130	GG/CI	S/E	213	optional	55
CL 100-200/2A		DN 100	flanges/flansche	230	57	PN 16	-10	130	GG/CI	S/E	220	optional	55
CL 100-250/2D		DN 100	flanges/flansche	210	69	PN 16	-10	130	GG/CI	S/E	135	optional	55

TEHNICAL DATA / TECHNISCHE DATEN

pump type pumpentyp	code artikelnummer	connection size rohranschluss DN (")	connection type rohranschluss	max. flow durchfluss Q (m ³ /h)	max. pressure druck H (m)	system pressure systemdruck PN (bar)	min. media temp. des medius T min. °C	max. media temp. des medius T max. °C	casing type werkstoffe GG / Cast iron	single-S, double-D einzelne-E, zwillings- bauform-Z	net weight Rein- gewicht (kg)	regulation geregelt yes /ja no /nein	degree of protection schutzart IP
CLD 40-125 /4Z		DN 40	flanges/flansche	7,5	4	PN 16	-10	130	GG/CI	D/Z	41	optional	55
CLD 40-125 /4Y		DN 40	flanges/flansche	9	4,5	PN 16	-10	130	GG/CI	D/Z	41	optional	55
CLD 40-125 /4X		DN 40	flanges/flansche	13	6,5	PN 16	-10	130	GG/CI	D/Z	41	optional	55
CLD 50-125 /4Y		DN 50	flanges/flansche	18	4,5	PN 16	-10	130	GG/CI	D/Z	44	optional	55
CLD 50-125 /4X		DN 50	flanges/flansche	21	6,5	PN 16	-10	130	GG/CI	D/Z	46	optional	55
CLD 50-160 /4X		DN 50	flanges/flansche	22	9	PN 16	-10	130	GG/CI	D/Z	52	optional	55
CLD 65-160 /4Z		DN 65	flanges/flansche	30	6,5	PN 16	-10	130	GG/CI	D/Z	65	optional	55
CLD 65-160 /4Y		DN 65	flanges/flansche	36	8,5	PN 16	-10	130	GG/CI	D/Z	65	optional	55
CLD 65-160 /4X		DN 65	flanges/flansche	39	9	PN 16	-10	130	GG/CI	D/Z	67	optional	55
CLD 80-160 /4W		DN 80	flanges/flansche	48	6	PN 16	-10	130	GG/CI	D/Z	72	optional	55
CLD 80-160 /4Z		DN 80	flanges/flansche	54	7,2	PN 16	-10	130	GG/CI	D/Z	74	optional	55
CLD 80-160 /4Y		DN 80	flanges/flansche	62	8,7	PN 16	-10	130	GG/CI	D/Z	79	optional	55
CLD 80-160 /4X		DN 80	flanges/flansche	68	10,3	PN 16	-10	130	GG/CI	D/Z	83	optional	55
CLD 100-200 /4W		DN 100	flanges/flansche	80	8,5	PN 16	-10	130	GG/CI	D/Z	130	optional	55
CLD 100-200 /4Z		DN 100	flanges/flansche	95	10	PN 16	-10	130	GG/CI	D/Z	150	optional	55
CLD 100-200 /4Y		DN 100	flanges/flansche	110	12	PN 16	-10	130	GG/CI	D/Z	140	optional	55
CLD 100-200 /4X		DN 100	flanges/flansche	125	15	PN 16	-10	130	GG/CI	D/Z	170	optional	55
CLD 40-125/2D		DN 40	flanges/flansche	15	13	PN 16	-10	130	GG/CI	D/Z	50	optional	55
CLD 40-125/2C		DN 40	flanges/flansche	18	17	PN 16	-10	130	GG/CI	D/Z	50	optional	55
CLD 40-125/2B		DN 40	flanges/flansche	21	21	PN 16	-10	130	GG/CI	D/Z	52	optional	55
CLD 40-125/2A		DN 40	flanges/flansche	23	24,5	PN 16	-10	130	GG/CI	D/Z	54	optional	55
CLD 50-125/2C		DN 50	flanges/flansche	36	15,5	PN 16	-10	130	GG/CI	D/Z	66	optional	55
CLD 50-125/2B		DN 50	flanges/flansche	39	19	PN 16	-10	130	GG/CI	D/Z	66	optional	55
CLD 50-125/2A		DN 50	flanges/flansche	42	24,5	PN 16	-10	130	GG/CI	D/Z	66	optional	55
CLD 50-160/2B		DN 50	flanges/flansche	35	28	PN 16	-10	130	GG/CI	D/Z	67	optional	55
CLD 50-160/2A		DN 50	flanges/flansche	42	35	PN 16	-10	130	GG/CI	D/Z	86	optional	55
CLD 65-160/2D		DN 65	flanges/flansche	48	21	PN 16	-10	130	GG/CI	D/Z	81	optional	55
CLD 65-160/2C		DN 65	flanges/flansche	54	27	PN 16	-10	130	GG/CI	D/Z	101	optional	55
CLD 65-160/2B		DN 65	flanges/flansche	58	32	PN 16	-10	130	GG/CI	D/Z	108	optional	55
CLD 65-160/2A		DN 65	flanges/flansche	70	37	PN 16	-10	130	GG/CI	D/Z	125	optional	55
CLD 80-160/2D		DN 80	flanges/flansche	105	25	PN 16	-10	130	GG/CI	D/Z	187	optional	55
CLD 80-160/2C		DN 80	flanges/flansche	120	30	PN 16	-10	130	GG/CI	D/Z	175	optional	55
CLD 80-160/2B		DN 80	flanges/flansche	140	37	PN 16	-10	130	GG/CI	D/Z	162	optional	55
CLD 80-160/2A		DN 80	flanges/flansche	150	41	PN 16	-10	130	GG/CI	D/Z	148	optional	55
CLD 100-200/2F		DN 100	flanges/flansche	240	33	PN 16	-10	130	GG/CI	D/Z	230	optional	55
CLD 100-200/2E		DN 100	flanges/flansche	260	38	PN 16	-10	130	GG/CI	D/Z	214	optional	55
CLD 100-200/2D		DN 100	flanges/flansche	180	42	PN 16	-10	130	GG/CI	D/Z	200	optional	55
CLD 100-200/2C		DN 100	flanges/flansche	190	47	PN 16	-10	130	GG/CI	D/Z	214	optional	55
CLD 100-200/2B		DN 100	flanges/flansche	220	55	PN 16	-10	130	GG/CI	D/Z	230	optional	55
CLD 100-200/2A		DN 100	flanges/flansche	230	57	PN 16	-10	130	GG/CI	D/Z	230	optional	55

DIMENSIONS / MAßE

	pump type pumpentyp	code artikelnummer	length einbaulänge L (mm)	DN	L	L1	a	b	c	d
1	CV 32 - 4 / 60	979521532	200	32	200	100	277	164,5	70,5	42
	CV 32 - 4 / 70	979521531	200	32	200	100	277	164,5	70,5	42
	CV 32 - 4 / 80	979521530	200	32	200	100	277	164,5	70,5	42
	CV 32 - 2 / 60	979521529	200	32	200	100	277	164,5	70,5	42
	CV 32 - 2 / 70	979521528	200	32	200	100	277	164,5	70,5	42
	CV 32 - 2 / 80	979521527	200	200	32	200	100	277	164,5	70,5

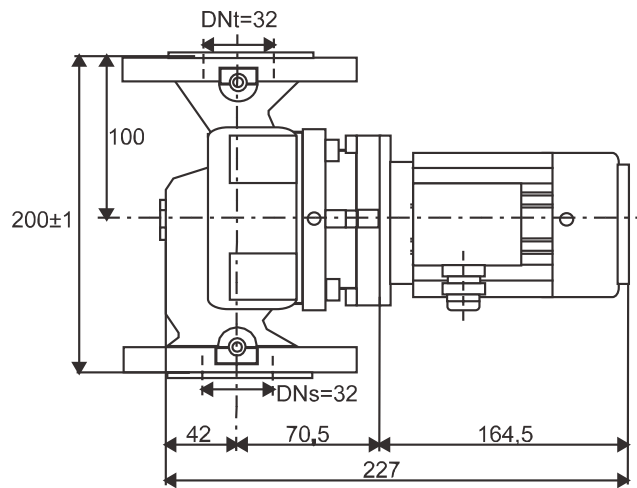

DIMENSIONS / MAßE

2

pump type pumpentyp	code artikelnummer	length einbaulänge L/A (mm)	DN	a/B	f	b1/E	b2/F	h1/I	h2/H	d	h3	l1/C	Pg	l	x
CL 40-140/4	979520775	390	40	90	163	145	135	190	200	200	138	249	16	502	100
CL 40-110/4	979521582	390	40	90	163	145	135	190	200	200	138	249	13,5	487	100
CL 40-90/4	979522606	360	40	90	155	133	127	180	180	200	130	234	13,5	479	100
CL 40-60/4	979520774	340	40	90	155	113	106	160	180	200	130	234	13,5	479	100
CL 50-140.1/4	979521584	425	50	96	159	150	135	205	220	200	138	274	16	512	100
CL 50-140.2/4	979522778	425	50	96	159	150	135	205	220	200	138	274	16	527	100
CL 50-120.1/4	979521586	425	50	96	159	150	135	205	220	200	138	274	13,5	489	100
CL 50-120.2/4	979521585	425	50	96	159	150	135	205	220	200	138	274	16	512	100
CL 50-110.1/4	979521588	425	50	96	159	150	135	205	220	200	138	274	13,5	489	100
CL 50-110.2/4	979521587	425	50	96	159	150	135	205	220	200	138	274	16	512	100
CL 50-100/4	979521589	425	50	96	159	150	135	205	220	200	138	274	13,5	489	100
CL 50-90/4	979521590	425	50	96	159	150	135	205	220	200	138	274	13,5	489	100
CL 50-80/4	979522777	380	50	96	159	138	126	180	200	200	138	249	16	512	100
CL 50-70/4	979521591	380	50	96	159	138	126	180	200	200	138	249	13,5	489	100
CL 50-50/4	979522776	340	50	96	159	240	107	160	180	200	130	234	13,5	489	100
CL 65-150/4	979522780	480	65	95	164	160	140	225	255	250	147	307	16	569	110
CL 65-120/4	979522773	480	65	95	164	160	140	225	255	250	147	307	16	531	110
CL 65-90.1/4	979522772	420	65	95	164	138	125	200	220	200	138	249	13,5	493	110
CL 65-90.2/4	979522779	420	65	95	164	138	125	200	220	200	138	249	16	516	110
CL 65-70/4	979521617	420	65	95	164	138	125	200	220	200	138	249	13,5	493	110
CL 65-50/4	979522771	390	65	95	164	135	110	180	210	200	130	234	13,5	493	110
CL 80-140.1/4	979521594	530	80	103	168	183	148	245	285	250	147	307	16	581	120
CL 80-140.2/4	979522783	530	80	103	168	183	148	245	285	250	147	307	16	581	120
CL 80-120/4	979522770	530	80	103	168	183	148	245	285	250	147	307	16	581	120
CL 80-110/4	979521595	530	80	103	168	183	148	245	285	250	147	307	16	581	120
CL 80-100.1/4	979522768	530	80	103	168	183	148	245	285	250	147	307	16	543	120
CL 80-100.2/4	979522769	530	80	103	168	183	148	245	285	250	147	307	16	581	120
CL 80-90/4	979522782	480	80	103	168	172	138	220	260	250	157	310	16	581	120
CL 80-80.1/4	979522766	480	80	103	168	172	138	220	260	250	147	307	16	543	120
CL 80-80.2/4	979522767	480	80	103	168	172	138	220	260	250	147	307	16	581	120
CL 80-60.1/4	979521596	440	80	103	168	158	124	200	240	200	138	249	13,5	505	120
CL 80-60.2/4	979522781	440	80	103	168	158	124	200	240	200	138	249	16	528	120
CL 80-60.3/4	979522765	440	80	103	168	185	124	200	240	200	121	272	16	543	120
CL 80-40.1/4	979521599	440	80	103	168	158	124	200	240	200	138	249	13,5	505	120
CL 80-40.2/4	979522764	440	80	103	168	158	124	200	240	200	138	249	13,5	505	120
CL 100-140.1/4	979521600	560	100	113	169	187	152	270	290	250	162	320	16	592	125
CL 100-140.2/4	979522785	560	100	113	169	187	152	270	290	250	162	320	16	602	125
CL 100-130.1/4	979521602	560	100	113	169	187	152	270	290	250	162	320	16	592	125
CL 100-130.2/4	979521601	560	100	113	169	187	152	270	290	250	162	320	16	592	125
CL 100-110/4	979521603	560	100	113	169	187	152	270	290	250	162	320	16	592	125
CL 100-90/4	979522784	520	100	113	169	180	140	245	275	250	147	307	16	592	125
CL 125-250/4W		620	125	195		195	195	280	340			550			
CL 125-250/4Z		620	125	195		195	195	280	340			550			
CL 125-250/4Y		620	125	195		195	195	280	340			550			
CL 125-250/4X		620	125	195		195	195	280	340			550			
CL 150-250/4W		700	150	220		210	210	330	370			555			
CL 150-250/4V		700	150	220		210	210	330	370			555			
CL 150-250/4Z		700	150	220		210	210	330	370			555			
CL 150-250/4Y		700	150	220		210	210	330	370			755			
CL 150-250/4X		700	150	220		210	210	330	370			755			

DIMENSIONS / MAßE

pump type pumpentyp	code artikelnummer	length einbaulänge L/A (mm)	DN	α/B	f	b1/E	b2/F	h1/I	h2/H	d	h3	l1/C	Pg	l	x
CL 401 - 2	979520867	390	40	90	188	145	135	190	200	300	200	361	21	639	100
CL 402 - 2	979520868	360	40	90	155	133	127	180	180	250	162	314	16	559	100
CL 403 - 2	979520869	340	40	90	155	113	106	160	180	250	147	314	16	559	100
CL 501 - 2	979520870	425	50	96	214	150	135	205	220	350	236	479	29	789	100
CL 502 - 2	979520871	380	50	96	184	138	126	180	200	300	200	361	21	641	100
CL 503 - 2	979520872	340	50	96	159	124	107	160	180	250	147	314	16	569	100
CL 651 - 2	979520873	480	65	95	219	160	140	225	255	350	236	521	29	835	110
CL 652 - 2	979520874	420	65	95	189	138	125	200	220	300	200	361	21	611	110
CL 653 - 2	979520875	390	65	95	189	135	110	180	210	300	200	361	21	611	110
CL 801 - 2	979520876	530	80	103	223	183	148	245	285	350	235	550	29	876	120
CL 802 - 2	979520877	480	80	103	223	172	138	225	255	350	236	521	29	847	120
CL 803 - 2	979520878	440	80	103	193	158	124	200	240	300	200	357	21	653	120
CL 32-100/2A		220	65	65		65	107	110	110			330			
CL 40-100/2B		240	65	75		77	107	110	130			330			
CL 40-100/2A		240	65	75		77	107	110	130			330			
CL 40-125/2C		300	65	100		93	107	140	160			325			
CL 40-125/2B		300	65	100		93	118	140	160			345			
CL 40-125/2A		300	65	100		93	118	140	160			345			
CL 40-160/2C		320	80	100		108	149	150	170			385			
CL 40-160/2B		320	80	100		108	149	150	170			385			
CL 40-160/2A		320	80	100		108	149	150	170			385			
CL 40-200/2C		380	80	100		127	159	180	200			425			
CL 40-200/2B		380	80	100		127	159	180	200			425			
CL 40-200/2A		380	80	100		127	159	180	200			425			
CL 50-125/2C		320	80	110		103	118	140	180			345			
CL 50-125/2B		320	80	110		103	118	140	180			345			
CL 50-125/2A		320	80	110		103	118	140	180			385			
CL 50-160/2B		340	80	110		113	149	160	180			385			
CL 50-160/2A		340	80	110		113	149	160	180			385			
CL 50-200/2C		400	80	110		131	159	180	220			435			
CL 50-200/2B		400	100	110		131	159	180	220			435			
CL 50-200/2A		400	100	110		131	184	180	220			540			
CL 65-125/2C		360	100	140		108	149	155	205			385			
CL 65-125/2B		360	100	140		108	149	155	205			385			
CL 65-125/2A		360	100	140		108	159	155	205			425			
CL 65-160/2B		400	100	140		122	159	180	220			435			
CL 65-160/2A		400	125	140		122	184	180	220			540			
CL 65-200/2B		440	125	140		136	184	200	240			540			
CL 65-200/2A		440	125	140		136	184	200	240			540			
CL 80-160/2C		440	125	160		131	184	200	240			540			
CL 80-160/2B		440	150	160		131	184	200	240			540			
CL 80-160/2A		440	150	160		131	184	200	240			540			
CL 80-200/2D		500	150	160		146	184	225	275			540			
CL 80-200/2C		500	150	160		146	229	225	275			700			
CL 80-200/2B		500	150	160		146	229	225	275			700			
CL 100-160/2D		525	100	190		136	184	225	300			540			
CL 100-160/2C		525	100	190		136	184	225	300			540			
CL 100-160/2B		525	100	190		136	184	225	300			540			

DIMENSIONS / MAßE

pump type pumpentyp	code artikelnummer	length einbaulänge L/A (mm)	DN	a/B	f	b1/E	b2/F	h1/l	h2/H	d	h3	l1/C	Pg	l	x
CL 100-200/2D		550	100	190		156	230	250	300			700			
CL 100-200/2C		550	100	190		156	257	250	300			805			
CL 100-200/2B		550	100	190		156	257	250	300			805			
CL 100-200/2A		570	100	190		176	257	250	320			805			
CL 100-250/2D		580	100	190		156	230	280	300			700			

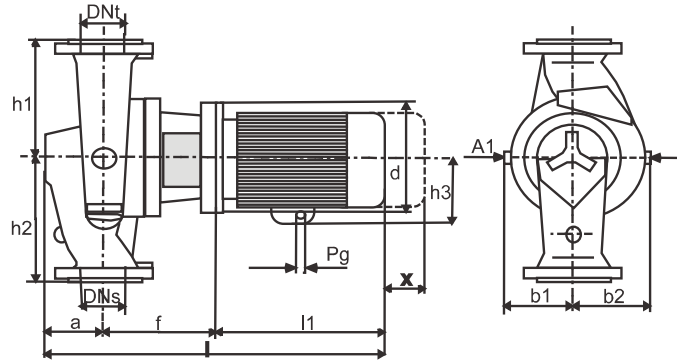

DIMENSIONS / MAßE

3

pump type pumpentyp	code artikelnummer	DN	A	B	C	D	E	F	G	H	I	L	M
CLD 40-125 /4Z		DN 40	425	100	345	397	200	197	340	130	210	20	100
CLD 40-125 /4Y		DN 40	425	100	345	397	200	197	340	130	210	20	100
CLD 40-125 /4X		DN 40	425	100	345	397	200	197	340	130	210	20	100
CLD 50-125 /4Y		DN 50	435	110	325	427	217	210	365	145	220	22	105
CLD 50-125 /4X		DN 50	435	110	325	427	217	210	365	145	220	22	105
CLD 50-160 /4X		DN 50	435	110	325	480	245	235	410	170	240	22	120
CLD 65-160 /4Z		DN 65	475	130	345	543	275	268	450	180	270	22	140
CLD 65-160 /4Y		DN 65	475	130	345	543	275	268	450	180	270	22	140
CLD 65-160 /4X		DN 65	475	130	345	543	275	268	450	180	270	22	140
CLD 80-160 /4W		DN 80	485	150	385	550	280	270	510	205	305	24	135
CLD 80-160 /4Z		DN 80	485	150	385	550	280	270	510	205	305	24	135
CLD 80-160 /4Y		DN 80	535	150	385	550	280	270	510	205	305	24	135
CLD 80-160 /4X		DN 80	535	150	385	550	280	270	510	205	305	24	135
CLD 100-200 /4W		DN 100	535	180	435	670	325	345	630	240	390	26	165
CLD 100-200 /4Z		DN 100	615	180	435	670	325	345	630	240	390	26	165
CLD 100-200 /4Y		DN 100	615	180	435	670	325	345	630	240	390	26	165
CLD 100-200 /4X		DN 100	615	180	435	670	325	345	630	240	390	26	165
CLD 40-125/2D		DN 40	445	100	345	397	200	197	340	130	210	20	100
CLD 40-125/2C		DN 40	445	100	345	397	200	197	340	130	210	20	100
CLD 40-125/2B		DN 40	425	100	345	397	200	197	340	130	210	20	100
CLD 40-125/2A		DN 40	425	100	345	397	200	197	340	130	210	20	100
CLD 50-125/2C		DN 50	495	110	385	427	217	210	365	145	220	22	105
CLD 50-125/2B		DN 50	495	110	385	427	217	210	365	145	220	22	105
CLD 50-125/2A		DN 50	495	110	385	427	217	210	365	145	220	22	105
CLD 50-160/2B		DN 50	495	110	385	480	245	235	410	170	240	22	120
CLD 50-160/2A		DN 50	535	110	425	480	245	235	410	170	240	22	120
CLD 65-160/2D		DN 65	515	130	385	543	275	268	450	180	270	22	140
CLD 65-160/2C		DN 65	565	130	435	543	275	268	450	180	270	22	140
CLD 65-160/2B		DN 65	565	130	435	543	275	268	450	180	270	22	140
CLD 65-160/2A		DN 65	670	130	540	543	275	268	450	180	270	22	140
CLD 80-160/2D		DN 80	640	150	540	550	280	270	510	205	305	24	135
CLD 80-160/2C		DN 80	690	150	540	550	280	270	510	205	305	24	135
CLD 80-160/2B		DN 80	690	150	540	550	280	270	510	205	305	24	135
CLD 80-160/2A		DN 80	690	150	540	550	280	270	510	205	305	24	135
CLD 100-200/2F		DN 100	720	180	540	670	325	345	630	240	390	26	165
CLD 100-200/2E		DN 100	720	180	540	670	325	345	630	240	390	26	165
CLD 100-200/2D		DN 100	720	180	540	670	325	345	630	240	390	26	165
CLD 100-200/2C		DN 100	720	180	540	670	325	345	630	240	390	26	165
CLD 100-200/2B		DN 100	720	180	540	670	325	345	630	240	390	26	165
CLD 100-200/2A		DN 100	720	180	540	670	325	345	630	240	390	26	165

3

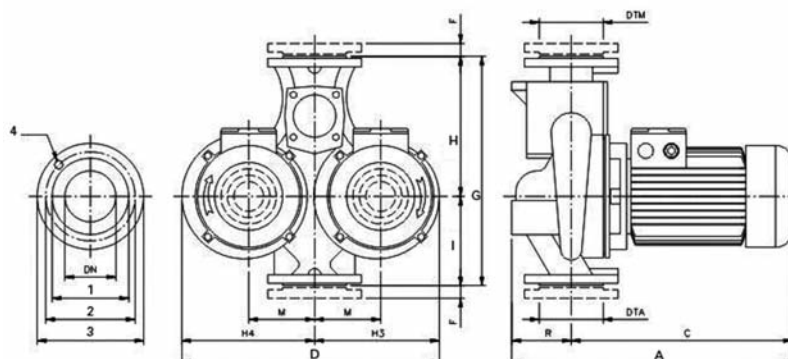

ELECTRICAL DATA / ELEKTRISCHE DATEN



pump type pumpentyp	code artikelnummer	power max. leistungsaufnahme P (W)	speed range drehzahlstufe (min-1)	FLC I nennstrom In (A)	electrical voltage elektroanschluss U (V)	insulating class isoliationsklasse
CV 32 - 4 / 60	979521532	120	1340	0,41	3 ~ 400 V	F
CV 32 - 4 / 70	979521531	120	1340	0,41	3 ~ 400 V	F
CV 32 - 4 / 80	979521530	120	1340	0,41	3 ~ 400 V	F
CV 32 - 2 / 60	979521529	250	2750	0,64	3 ~ 400 V	F
CV 32 - 2 / 70	979521528	250	2750	0,64	3 ~ 400 V	F
CV 32 - 2 / 80	979521527	250	2750	0,64	3 ~ 400 V	F

ELECTRICAL DATA / ELEKTRISCHE DATEN



pump type pumpentyp	code artikelnummer	power max. leistungsaufnahme P (W)	speed range drehzahlstufe (min ⁻¹)	FLC I nennstrom I _n (A)	electrical voltage elektroanschluss U (V)	insulating class isoliationsklasse
CL 40-140/4	979522775	1100	1500	2,4	3 ~ 400 V	F
CL 40-110/4	979521582	750	1500	1,63	3 ~ 400 V	F
CL 40-90/4	979522606	550	1500	1,27	3 ~ 400 V	F
CL 40-60/4	979522774	550	1500	1,27	3 ~ 400 V	F
CL 50-140.1/4	979521584	1100	1500	2,4	3 ~ 400 V	F
CL 50-140.2/4	979522778	1500	1500	3,26	3 ~ 400 V	F
CL 50-120.1/4	979521586	750	1500	1,63	3 ~ 400 V	F
CL 50-120.2/4	979521585	1100	1500	2,4	3 ~ 400 V	F
CL 50-110.1/4	979521588	750	1500	1,63	3 ~ 400 V	F
CL 50-110.2/4	979521587	1100	1500	2,4	3 ~ 400 V	F
CL 50-100/4	979521589	750	1500	1,63	3 ~ 400 V	F
CL 50-90/4	979521590	550	1500	1,27	3 ~ 400 V	F
CL 50-80/4	979522777	1100	1500	2,4	3 ~ 400 V	F
CL 50-70/4	979521591	550	1500	1,27	3 ~ 400 V	F
CL 50-50/4	979522776	550	1500	1,27	3 ~ 400 V	F
CL 65-150/4	979522780	2200	1500	4,64	3 ~ 400 V	F
CL 65-120/4	979522773	1500	1500	3,26	3 ~ 400 V	F
CL 65-90.1/4	979522772	750	1500	1,63	3 ~ 400 V	F
CL 65-90.2/4	979522779	1100	1500	2,4	3 ~ 400 V	F
CL 65-70/4	979521617	750	1500	1,63	3 ~ 400 V	F
CL 65-50/4	979522771	550	1500	1,27	3 ~ 400 V	F
CL 80-140.1/4	979521594	2200	1500	4,64	3 ~ 400 V	F
CL 80-140.2/4	979522783	3000	1500	6,17	3 ~ 400 V	F
CL 80-120/4	979522770	2200	1500	4,64	3 ~ 400 V	F
CL 80-110/4	979521595	2200	1500	4,64	3 ~ 400 V	F
CL 80-100.1/4	979522768	1500	1500	3,26	3 ~ 400 V	F
CL 80-100.2/4	979522769	2200	1500	4,64	3 ~ 400 V	F
CL 80-90/4	979522782	2200	1500	4,64	3 ~ 400 V	F
CL 80-80.1/4	979522766	1500	1500	3,26	3 ~ 400 V	F
CL 80-80.2/4	979522767	2200	1500	4,64	3 ~ 400 V	F
CL 80-60.1/4	979521596	750	1500	1,63	3 ~ 400 V	F
CL 80-60.2/4	979522781	1100	1500	2,4	3 ~ 400 V	F
CL 80-60.3/4	979522765	1500	1500	3,26	3 ~ 400 V	F
CL 80-40.1/4	979521599	550	1500	1,27	3 ~ 400 V	F
CL 80-40.2/4	979522764	750	1500	1,63	3 ~ 400 V	F
CL 100-140.1/4	979521600	3000	1500	6,17	3 ~ 400 V	F
CL 100-140.2/4	979522785	4000	1500	8,11	3 ~ 400 V	F
CL 100-130.1/4	979521602	2200	1500	4,64	3 ~ 400 V	F
CL 100-130.2/4	979521601	3000	1500	6,17	3 ~ 400 V	F
CL 100-110/4	979521603	2200	1500	4,64	3 ~ 400 V	F
CL 100-90/4	979522784	3000	1500	6,17	3 ~ 400 V	F
CL 125-250/4W		5500	1500	11	3 ~ 400 V	F
CL 125-250/4Z		5500	1500	11	3 ~ 400 V	F
CL 125-250/4Y		7500	1500	15	3 ~ 400 V	F
CL 125-250/4X		9200	1500	19	3 ~ 400 V	F
CL 150-250/4W		7500	1500	15	3 ~ 400 V	F
CL 150-250/4V		9200	1500	19	3 ~ 400 V	F
CL 150-250/4Z		11000	1500	22	3 ~ 400 V	F
CL 150-250/4Y		15000	1500	30	3 ~ 400 V	F
CL 150-250/4X		15000	1500	30	3 ~ 400 V	F

ELECTRICAL DATA / ELEKTRISCHE DATEN



pump type pumpentyp	code artikelnummer	power max. leistungsaufnahme P (W)	speed range drehzahlstufe (min-1)	FLC I nennstrom In (A)	electrical voltage elektroanschluss U (V)	insulating class isoliationsklasse
CL 401 - 2	979520867	5500	3000	10,6	3 ~ 400 V	F
CL 402 - 2	979520868	4000	3000	7,72	3 ~ 400 V	F
CL 403 - 2	979520869	3000	3000	5,92	3 ~ 400 V	F
CL 501 - 2	979520870	11000	3000	20,4	3 ~ 400 V	F
CL 502 - 2	979520871	5500	3000	10,6	3 ~ 400 V	F
CL 503 - 2	979520872	3000	3000	5,92	3 ~ 400 V	F
CL 651 - 2	979520873	15000	3000	27,6	3 ~ 400 V	F
CL 652 - 2	979520874	7500	3000	14,1	3 ~ 400 V	F
CL 653 - 2	979520875	5500	3000	10,6	3 ~ 400 V	F
CL 801 - 2	979520876	22000	3000	39,1	3 ~ 400 V	F
CL 802 - 2	979520877	18500	3000	33,7	3 ~ 400 V	F
CL 803 - 2	979520878	7500	3000	14,1	3 ~ 400 V	F
CL 32-100/2A		370	3000	0,8	3 ~ 400 V	F
CL 40-100/2B		550	3000	1,1	3 ~ 400 V	F
CL 40-100/2A		750	3000	1,5	3 ~ 400 V	F
CL 40-125/2C		750	3000	1,5	3 ~ 400 V	F
CL 40-125/2B		1000	3000	2	3 ~ 400 V	F
CL 40-125/2A		1500	3000	3	3 ~ 400 V	F
CL 40-160/2C		2000	3000	4	3 ~ 400 V	F
CL 40-160/2B		3000	3000	6	3 ~ 400 V	F
CL 40-160/2A		3000	3000	6	3 ~ 400 V	F
CL 40-200/2C		4000	3000	8	3 ~ 400 V	F
CL 40-200/2B		5500	3000	11	3 ~ 400 V	F
CL 40-200/2A		6300	3000	13	3 ~ 400 V	F
CL 50-125/2C		1500	3000	3	3 ~ 400 V	F
CL 50-125/2B		2000	3000	4	3 ~ 400 V	F
CL 50-125/2A		3000	3000	6	3 ~ 400 V	F
CL 50-160/2B		3000	3000	6	3 ~ 400 V	F
CL 50-160/2A		4000	3000	8	3 ~ 400 V	F
CL 50-200/2C		5500	3000	11	3 ~ 400 V	F
CL 50-200/2B		6300	3000	13	3 ~ 400 V	F
CL 50-200/2A		7500	3000	15	3 ~ 400 V	F
CL 65-125/2C		2000	3000	4	3 ~ 400 V	F
CL 65-125/2B		3000	3000	6	3 ~ 400 V	F
CL 65-125/2A		4000	3000	8	3 ~ 400 V	F
CL 65-160/2B		5500	3000	11	3 ~ 400 V	F
CL 65-160/2A		7500	3000	15	3 ~ 400 V	F
CL 65-200/2B		10000	3000	20	3 ~ 400 V	F
CL 65-200/2A		12500	3000	25	3 ~ 400 V	F
CL 80-160/2C		10000	3000	20	3 ~ 400 V	F
CL 80-160/2B		12500	3000	25	3 ~ 400 V	F
CL 80-160/2A		15000	3000	30	3 ~ 400 V	F
CL 80-200/2D		15000	3000	30	3 ~ 400 V	F
CL 80-200/2C		18500	3000	37	3 ~ 400 V	F
CL 80-200/2B		22000	3000	44	3 ~ 400 V	F
CL 100-160/2D		10000	3000	20	3 ~ 400 V	F
CL 100-160/2C		12500	3000	25	3 ~ 400 V	F
CL 100-160/2B		15000	3000	30	3 ~ 400 V	F

ELECTRICAL DATA / ELEKTRISCHE DATEN



pump type pumpentyp	code artikelnummer	power max. leistungsaufnahme P (W)	speed range drehzahlstufe (min ⁻¹)	FLC I nennstrom I _n (A)	electrical voltage elektroanschluss U (V)	insulating class isoliationsklasse
CL 100-200/2D		18500	3000	37	3 ~ 400 V	F
CL 100-200/2C		22000	3000	44	3 ~ 400 V	F
CL 100-200/2B		30000	3000	60	3 ~ 400 V	F
CL 100-200/2A		37000	3000	74	3 ~ 400 V	F
CL 100-250/2D		37000	3000	74	3 ~ 400 V	F

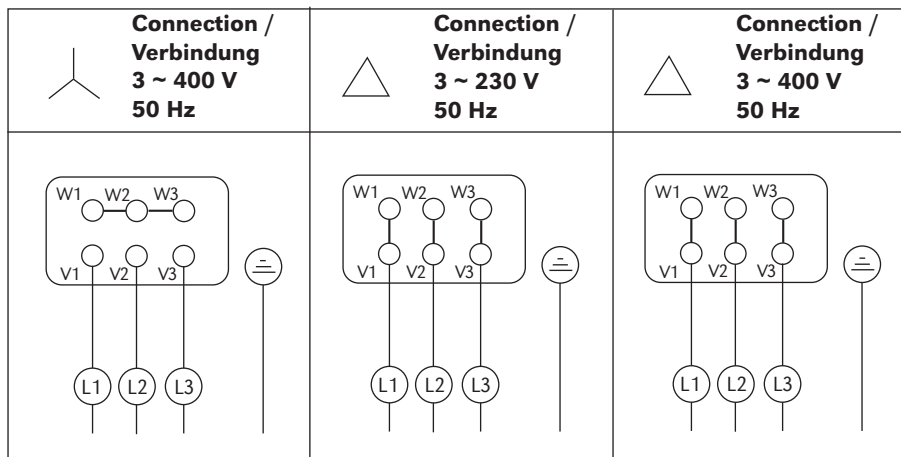

ELECTRICAL DATA / ELEKTRISCHE DATEN



pump type pumpentyp	code artikelnummer	power max. leistungsaufnahme P (W)	speed range drehzahlstufe (min ⁻¹)	FLC I nennstrom I _n (A)	electrical voltage elektroanschluss U (V)	insulating class isolationsklasse
CLD 40-125 /4Z		250	1500	0,5	3 ~ 400 V	F
CLD 40-125 /4Y		250	1500	0,5	3 ~ 400 V	F
CLD 40-125 /4X		250	1500	0,5	3 ~ 400 V	F
CLD 50-125 /4Y		250	1500	0,5	3 ~ 400 V	F
CLD 50-125 /4X		370	1500	0,8	3 ~ 400 V	F
CLD 50-160 /4X		500	1500	1	3 ~ 400 V	F
CLD 65-160 /4Z		550	1500	1,1	3 ~ 400 V	F
CLD 65-160 /4Y		750	1500	1,5	3 ~ 400 V	F
CLD 65-160 /4X		900	1500	1,8	3 ~ 400 V	F
CLD 80-160 /4W		750	1500	1,5	3 ~ 400 V	F
CLD 80-160 /4Z		900	1500	1,8	3 ~ 400 V	F
CLD 80-160 /4Y		1100	1500	2,2	3 ~ 400 V	F
CLD 80-160 /4X		1500	1500	3	3 ~ 400 V	F
CLD 100-200 /4W		1500	1500	3	3 ~ 400 V	F
CLD 100-200 /4Z		2200	1500	4,4	3 ~ 400 V	F
CLD 100-200 /4Y		3000	1500	6	3 ~ 400 V	F
CLD 100-200 /4X		4000	1500	8	3 ~ 400 V	F
CLD 40-125/2D		550	3000	1,1	3 ~ 400 V	F
CLD 40-125/2C		750	3000	1,5	3 ~ 400 V	F
CLD 40-125/2B		1000	3000	2	3 ~ 400 V	F
CLD 40-125/2A		1500	3000	3	3 ~ 400 V	F
CLD 50-125/2C		1500	3000	3	3 ~ 400 V	F
CLD 50-125/2B		2000	3000	4	3 ~ 400 V	F
CLD 50-125/2A		3000	3000	6	3 ~ 400 V	F
CLD 50-160/2B		3000	3000	6	3 ~ 400 V	F
CLD 50-160/2A		4000	3000	8	3 ~ 400 V	F
CLD 65-160/2D		3000	3000	6	3 ~ 400 V	F
CLD 65-160/2C		4000	3000	8	3 ~ 400 V	F
CLD 65-160/2B		5500	3000	11	3 ~ 400 V	F
CLD 65-160/2A		7500	3000	15	3 ~ 400 V	F
CLD 80-160/2D		7500	3000	15	3 ~ 400 V	F
CLD 80-160/2C		10000	3000	20	3 ~ 400 V	F
CLD 80-160/2B		12500	3000	25	3 ~ 400 V	F
CLD 80-160/2A		15000	3000	30	3 ~ 400 V	F
CLD 100-200/2F		12500	3000	25	3 ~ 400 V	F
CLD 100-200/2E		15000	3000	30	3 ~ 400 V	F
CLD 100-200/2D		10000	3000	20	3 ~ 400 V	F
CLD 100-200/2C		12500	3000	25	3 ~ 400 V	F
CLD 100-200/2B		15000	3000	30	3 ~ 400 V	F
CLD 100-200/2A		15000	3000	30	3 ~ 400 V	F

CB

CB



Block pumps / Trockenläuferpumpen



Block pumps Blockpumpen

TEHNICAL FEATURES / TECHNISCHE MERKMALE		CB
Connections / Nenweite	DN (")	40 do 80
Connection type / Rohranschluss		Flanges / Flansche
Flow max / Förderstrom max	Q (m ³ /h)	160
Pressure max / Förderhöhe	H (m)	60
Pressure rated / Betriebsdruck	PN (bar)	8 / 10
Power max / Leistungsaufnahme max	P (W)	22000
Electrical voltage / Elektroanschluss	V	3 ~ 400 V
Degree of protection / Schutzart	IP	54
Regulation / Regelung		optional
Media temperature / Temperaturbereich	T(°C)	-15 do +140
Insulating class / Isolationsklasse		F
Casing type / Werkstoffe		GG / Cast iron
Duble pump / Zwillingspumpe		no / nein
APPLICATIONS / EINSATZGEBIETE		
Heating / Warmwasserheizungen		✓
Cooling / Kaltwasseranlagen		✓
Sanitary water / Brauchwasser		
Climate appliances / Klimaanlage		✓
Industry / Industrieanlagen		✓
Process technique / Verfahrenstechnik		✓
Condensation / Kondensat		✓
Salt water / Meerwasser		

Pump markings / Typenschlüssel

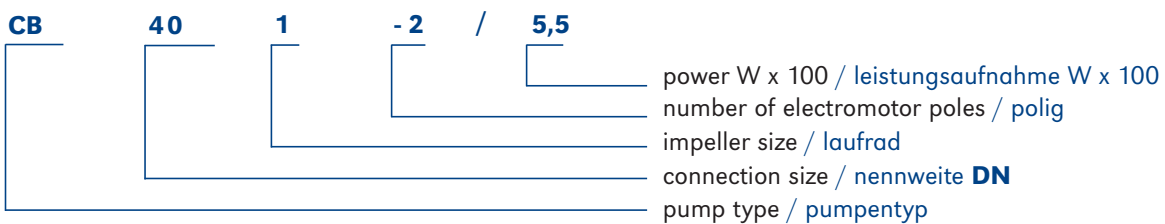

Permitted mounting positions / Einbaumöglichkeiten

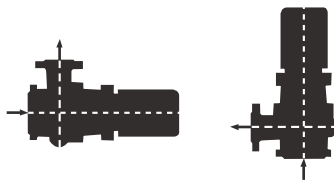

Block pumps
Blockpumpen

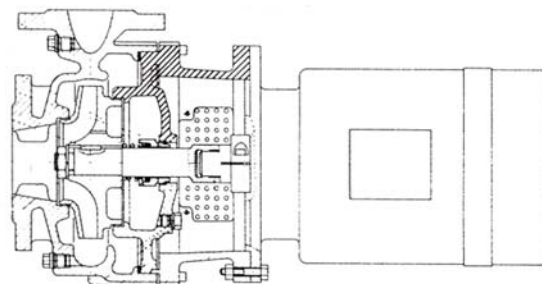
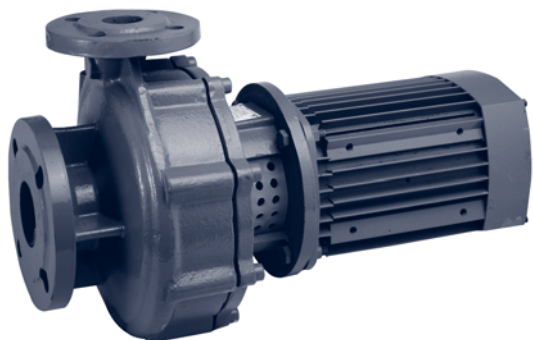

H (m)

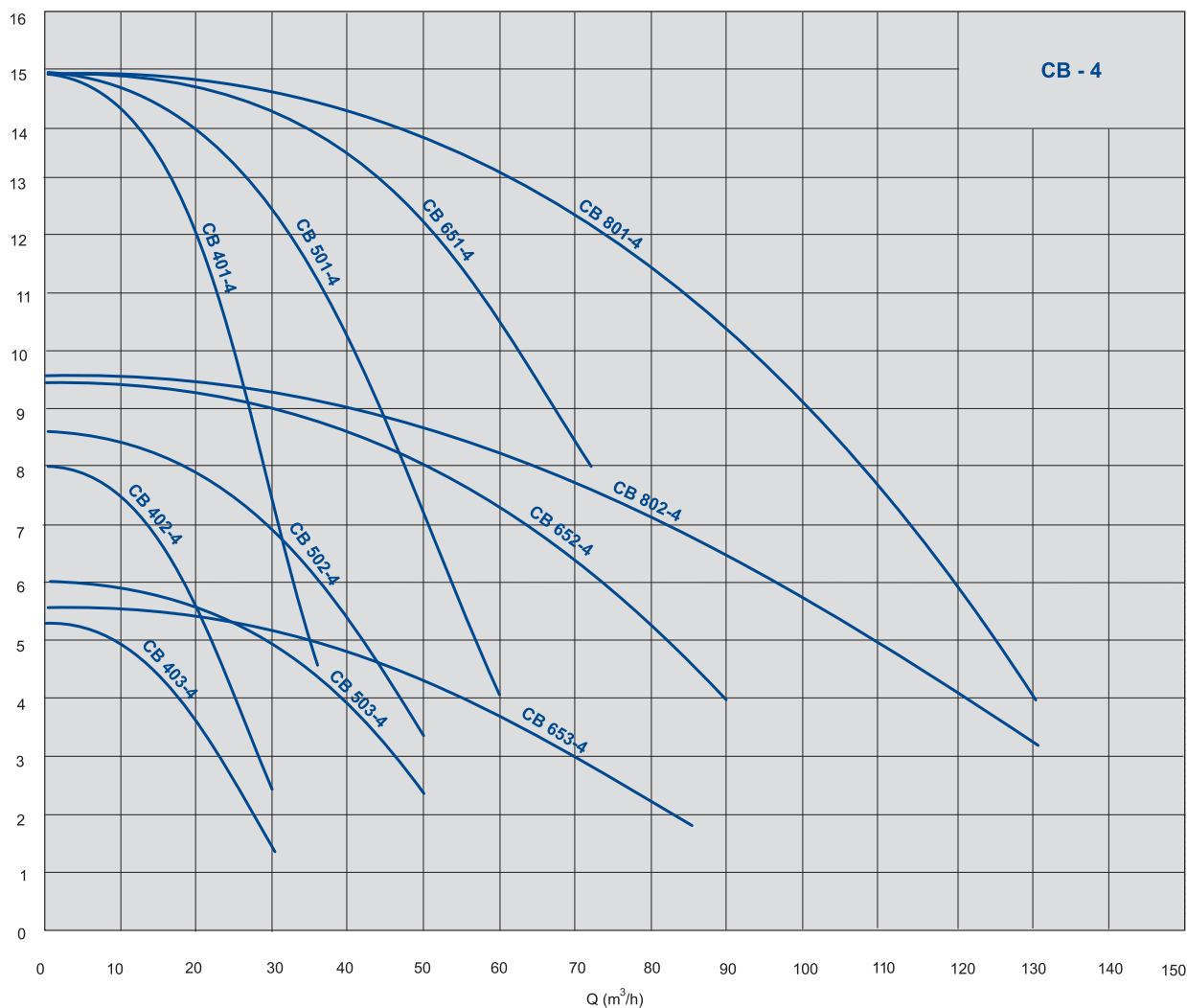

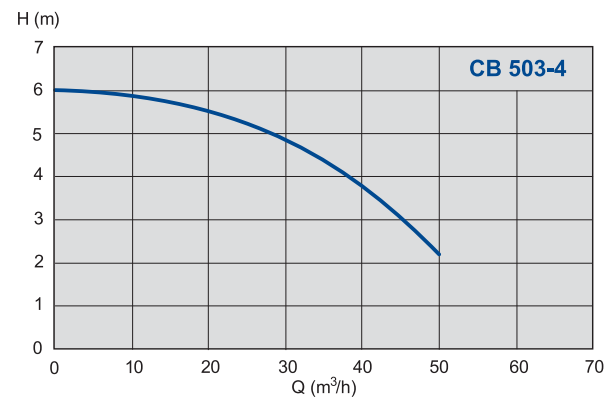
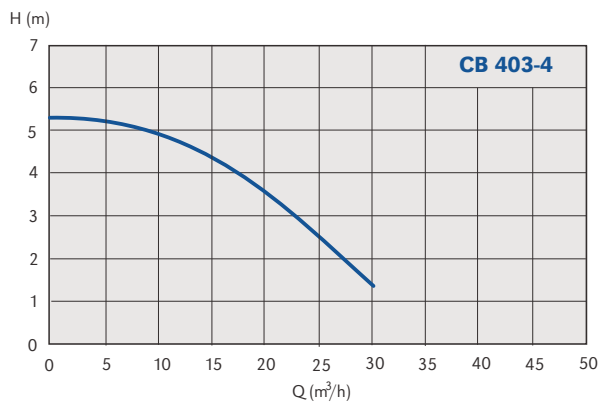
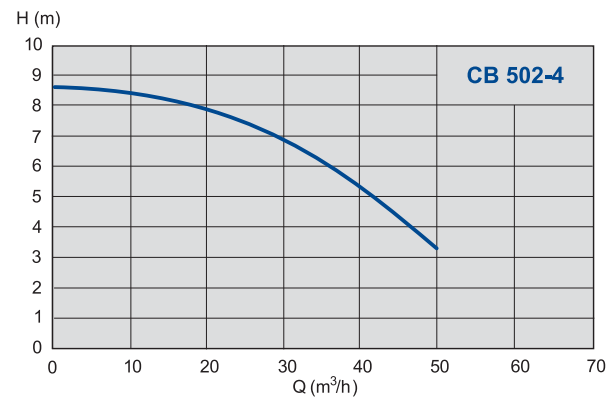
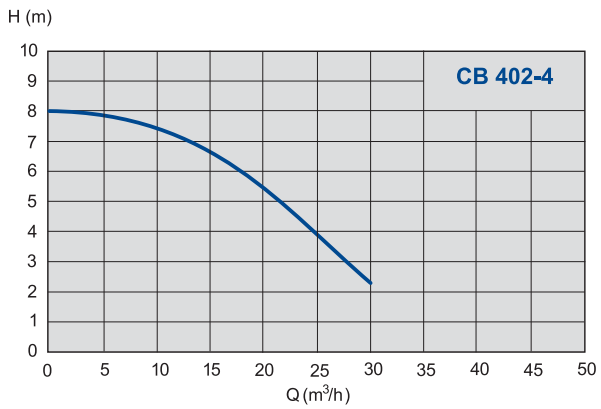
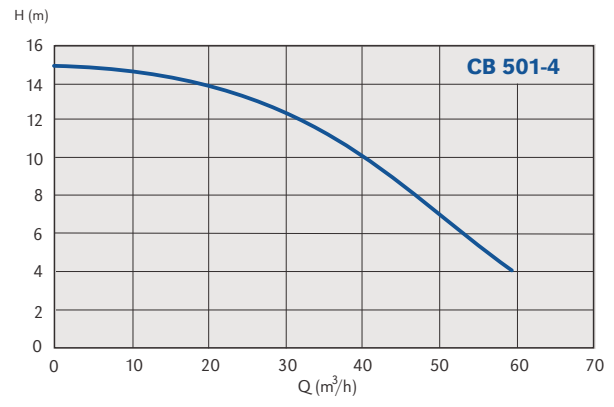
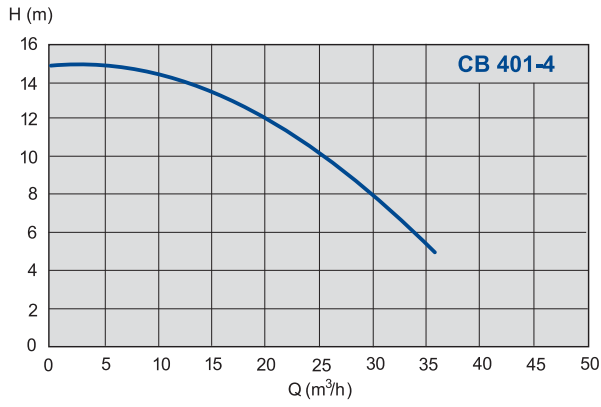

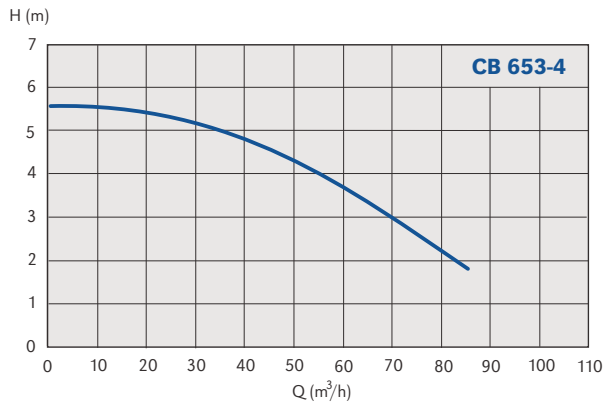
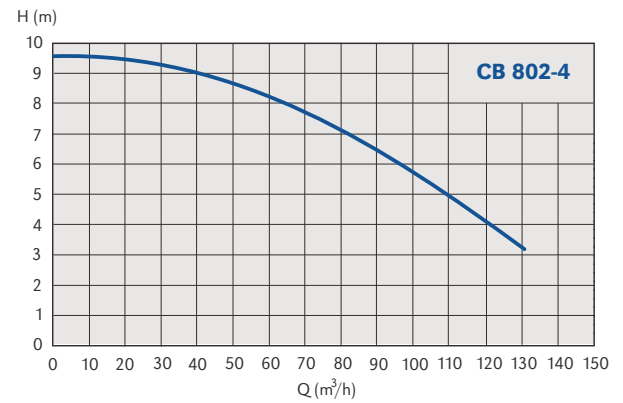
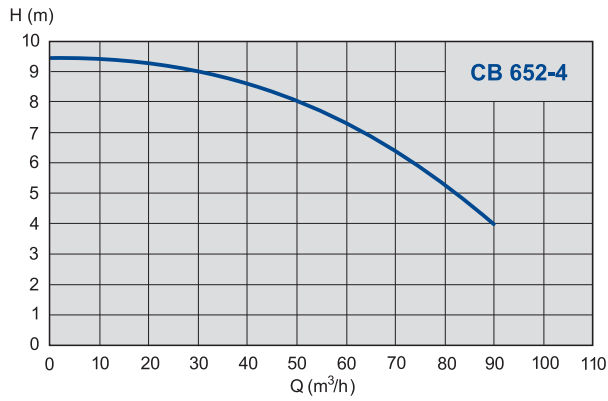
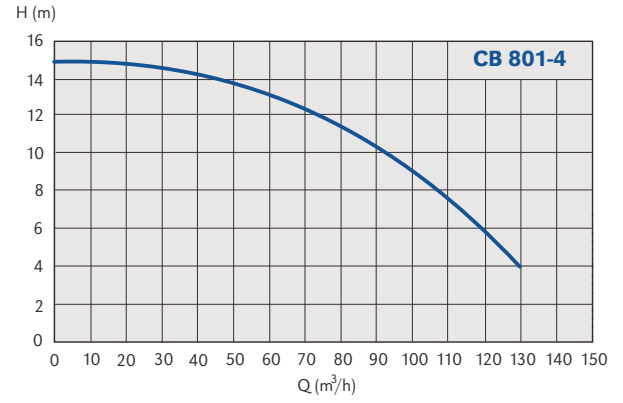
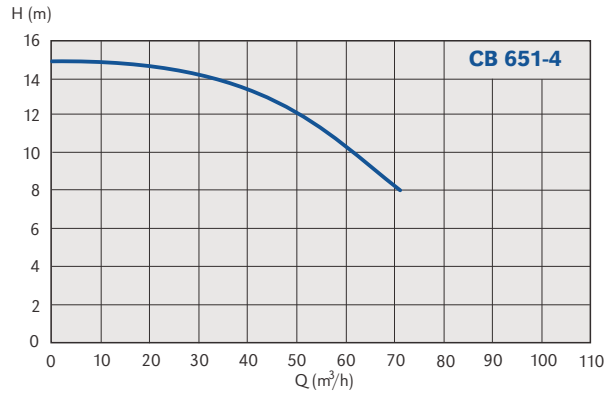

Block pumps
Blockpumpen

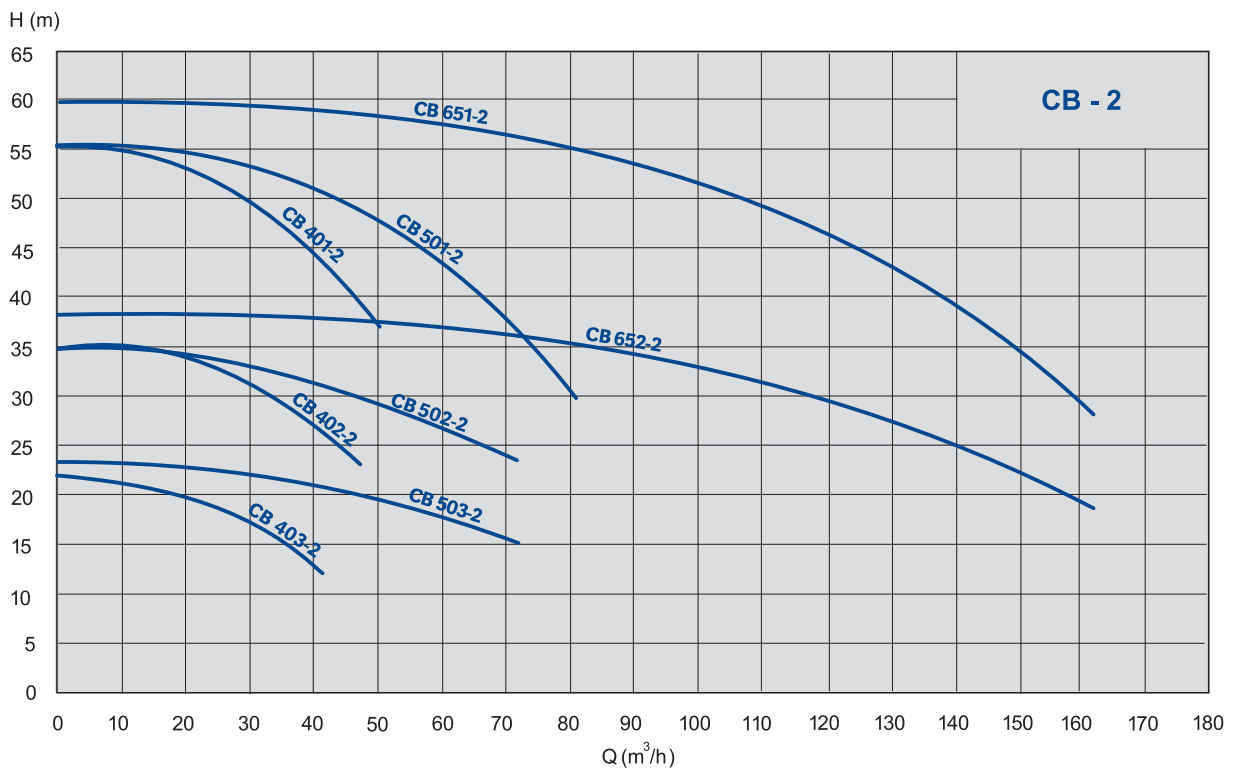
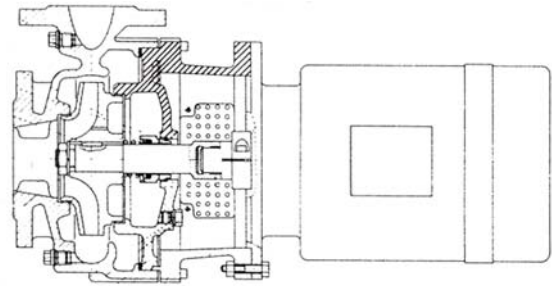
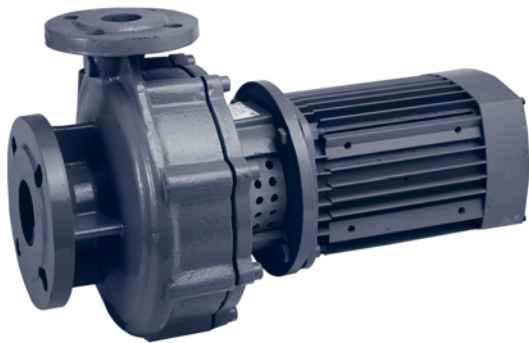

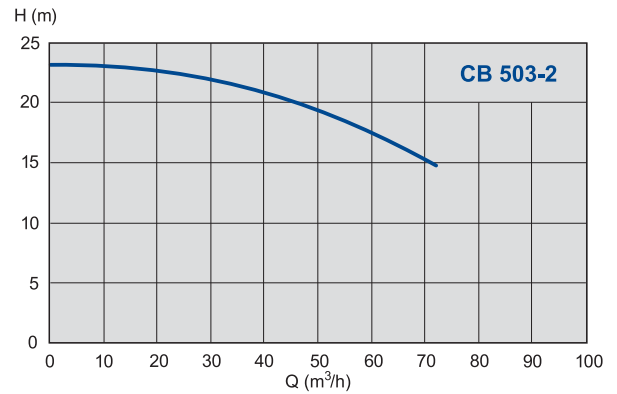
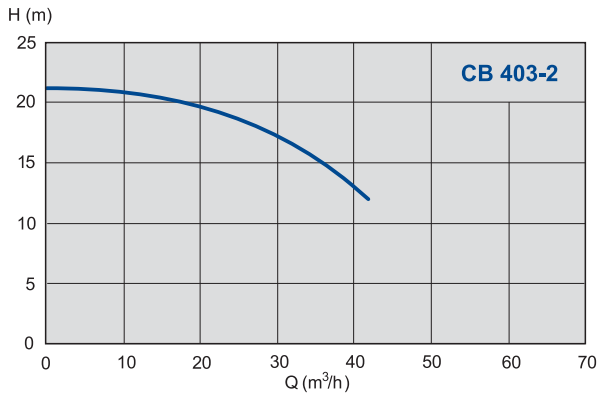
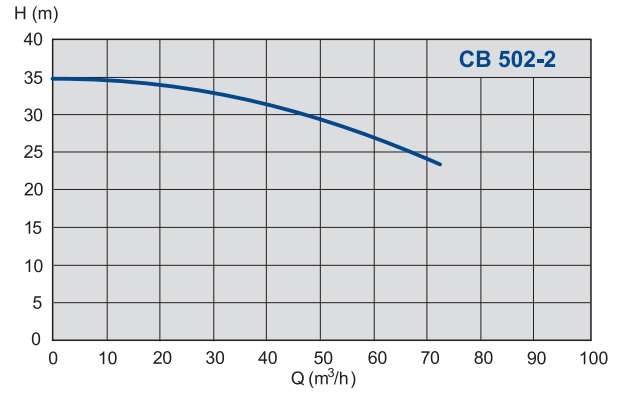
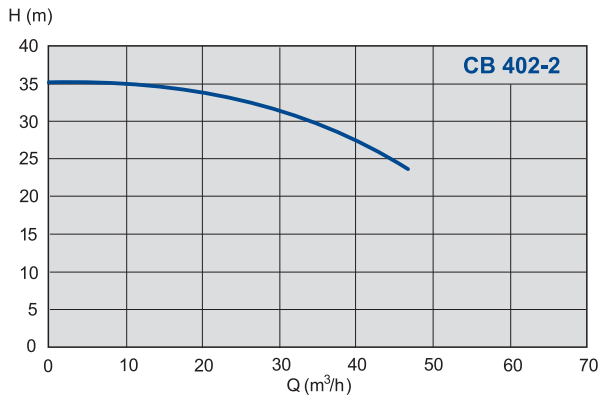
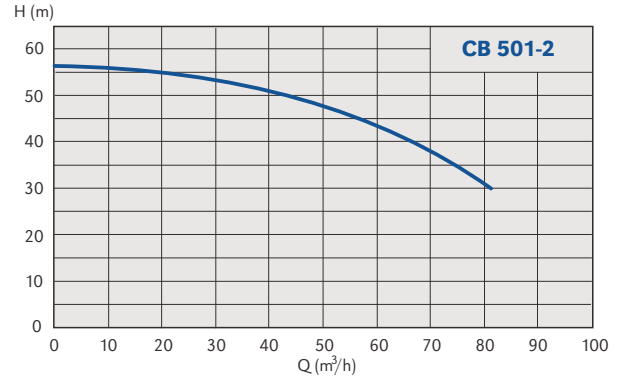
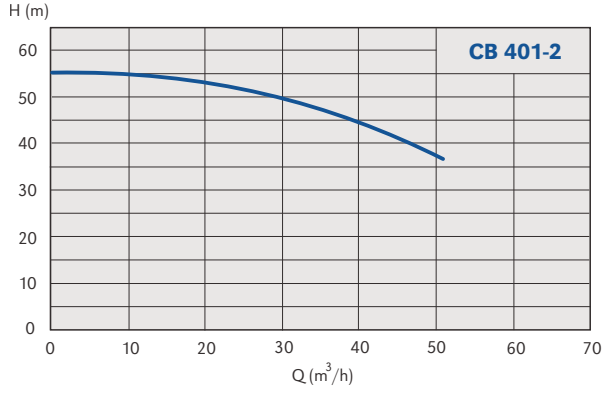

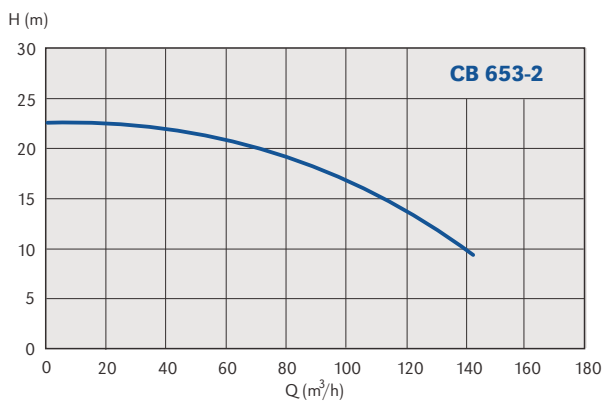
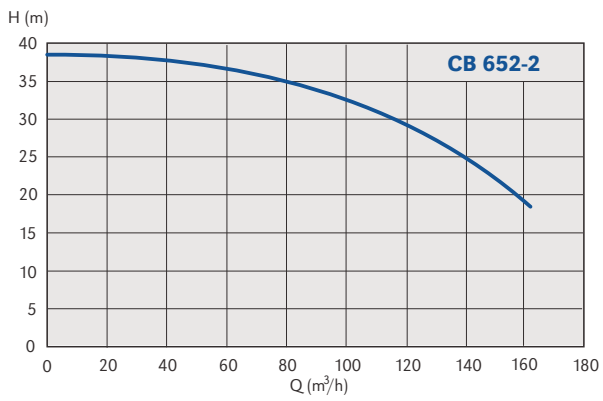
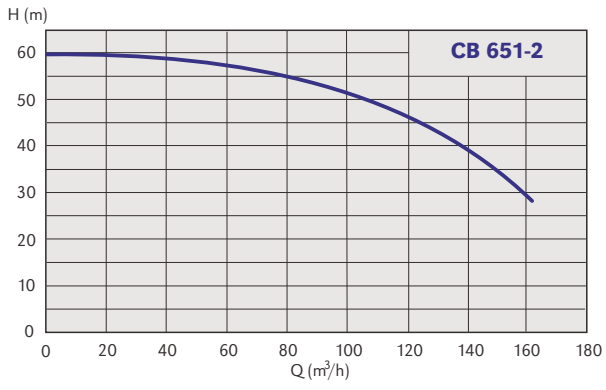

TEHNICAL DATA / TECHNISCHE DATEN

pump type pumpentyp	code artikelnummer	connection size rohranschluss DN (")	connection type rohranschluss	max. flow durchfluss Q (m ³ /h)	max. pressure druck H (m)	system pressure systemdruck PN (bar)	min. media temp. des medius T min. °C	max. media temp. des medius T max. °C	casing type werkstoffe GG / Cast iron	single-S, double-D einzelne-E, zwillings- bauform-Z	net weight Reinge- wicht (kg)	regulation geregelt yes /ja no /nein	degree of protection schutzart IP
CB 401 - 4	979520710	DN 40	flanges/flansche	36	15	PN 16	-15	140	GG/CI	S/E	42,5	optional	54
CB 402 - 4	979520711	DN 40	flanges/flansche	30	8	PN 16	-15	140	GG/CI	S/E	31	optional	54
CB 403 - 4	979520712	DN 40	flanges/flansche	30	5	PN 16	-15	140	GG/CI	S/E	39	optional	54
CB 501 - 4	979520713	DN 50	flanges/flansche	60	15	PN 16	-15	140	GG/CI	S/E	54	optional	54
CB 502 - 4	979520714	DN 50	flanges/flansche	50	8	PN 16	-15	140	GG/CI	S/E	44	optional	54
CB 503 - 4	979520715	DN 50	flanges/flansche	50	6	PN 16	-15	140	GG/CI	S/E	36	optional	54
CB 651 - 4	979520716	DN 65	flanges/flansche	70	15	PN 16	-15	140	GG/CI	S/E	64	optional	54
CB 652 - 4	979520717	DN 65	flanges/flansche	90	9	PN 16	-15	140	GG/CI	S/E	60	optional	54
CB 653 - 4	979520718	DN 65	flanges/flansche	85	5,5	PN 16	-15	140	GG/CI	S/E	42	optional	54
CB 801 - 4	979520719	DN 80	flanges/flansche	130	15	PN 16	-15	140	GG/CI	S/E	71	optional	54
CB 802 - 4	979520720	DN 80	flanges/flansche	130	9	PN 16	-15	140	GG/CI	S/E	72	optional	54
CB 401 - 2	979520471	DN 40	flanges/flansche	51	57	PN 16	-15	140	GG/CI	S/E	125	optional	54
CB 402 - 2	979520472	DN 40	flanges/flansche	47	32	PN 16	-15	140	GG/CI	S/E	68	optional	54
CB 403 - 2	979520473	DN 40	flanges/flansche	42	22	PN 16	-15	140	GG/CI	S/E	63	optional	54
CB 501 - 2	979520474	DN 50	flanges/flansche	80	57	PN 16	-15	140	GG/CI	S/E	151	optional	54
CB 502 - 2	979520475	DN 50	flanges/flansche	72	32	PN 16	-15	140	GG/CI	S/E	95	optional	54
CB 503 - 2	979520476	DN 50	flanges/flansche	72	25	PN 16	-15	140	GG/CI	S/E	72	optional	54
CB 651 - 2	979520477	DN 65	flanges/flansche	160	57	PN 16	-15	140	GG/CI	S/E	200	optional	54
CB 652 - 2	979520478	DN 65	flanges/flansche	160	37	PN 16	-15	140	GG/CI	S/E	170	optional	54
CB 653 - 2	979520479	DN 65	flanges/flansche	140	23	PN 16	-15	140	GG/CI	S/E	100	optional	54

DIMENSIONS / MAßE

pump type pumpentyp	code artikelnummer	DN	DNt	a	f	b1	b2	h1	h2	a1	d	h3	l1	Pg	l	x
CB 401 - 4	979520710	65	40	100	158	128	135	182	180	200	180	138	274	16	532	100
CB 402 - 4	979520711	65	40	80	158	123	123	182	160	200	180	138	249	16	487	100
CB 403 - 4	979520712	65	40	80	158	99	105	182	140	200	157	130	234	13,5	472	100
CB 501 - 4	979520713	65	50	100	163	127	143	182	200	250	200	147	307	16	570	110
CB 502 - 4	979520714	65	50	100	163	123	130	182	180	200	180	138	249	16	511	110
CB 503 - 4	979520715	65	50	100	163	100	117	182	160	200	157	130	234	13,5	497	110
CB 651 - 4	979520716	80	65	100	167	133	152	182	225	250	200	147	307	16	574	120
CB 652 - 4	979520717	80	65	100	167	123	130	182	200	250	200	147	307	16	574	120
CB 653 - 4	979520718	80	65	100	167	105	129	182	180	200	180	138	249	16	516	120
CB 801 - 4	979520719	100	80	125	168	144	178	182	250	250	222	162	320	16	613	125
CB 802 - 4	979520720	100	80	125	170	131	154	182	225	250	200	147	307	16	602	125
CB 401 - 2	979520471	65	40	100	214	128	135	182	180	350	319	236	479	29	793	100
CB 402 - 2	979520472	65	40	80	184	123	123	182	160	300	260	200	361	21	625	100
CB 403 - 2	979520473	65	40	80	159	99	105	182	140	250	198	147	314	16	553	100
CB 501 - 2	979520474	65	50	100	219	127	143	182	225	350	318	236	523	29	842	110
CB 502 - 2	979520475	65	50	100	189	123	130	182	200	350	260	200	361	21	650	110
CB 503 - 2	979520476	65	50	100	189	100	117	182	180	300	260	200	361	21	650	110
CB 651 - 2	979520477	80	65	100	223	133	152	182	250	350	318	235	523	29	846	120
CB 652 - 2	979520478	80	65	100	223	123	130	182	225	350	318	236	479	29	802	120
CB 653 - 2	979520479	80	65	103	193	105	129	182	180	300	318	200	361	21	657	120

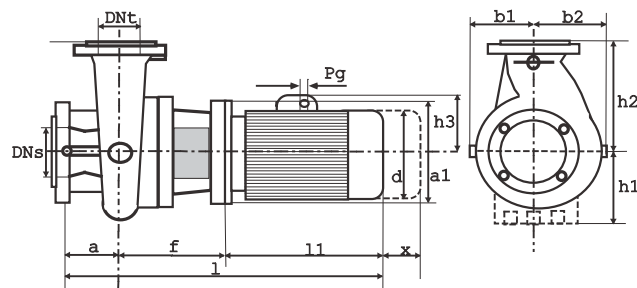

ELECTRICAL DATA / ELEKTRISCHE DATEN

pump type pumpentyp	code artikelnummer	power max. leistungsaufnahme P (W)	speed range drehzahlstufe (min ⁻¹)	FLC I nennstrom I _n (A)	electrical voltage elektroanschluss U (V)	insulating class isoliationsklasse
CB 401 - 4	979520710	1500	1500	3,26	3 ~ 400 V	F
CB 402 - 4	979520711	1100	1500	2,4	3 ~ 400 V	F
CB 403 - 4	979520712	550	1500	1,27	3 ~ 400 V	F
CB 501 - 4	979520713	2200	1500	4,64	3 ~ 400 V	F
CB 502 - 4	979520714	1100	1500	2,4	3 ~ 400 V	F
CB 503 - 4	979520715	750	1500	1,63	3 ~ 400 V	F
CB 651 - 4	979520716	3000	1500	6,17	3 ~ 400 V	F
CB 652 - 4	979520717	2200	1500	4,64	3 ~ 400 V	F
CB 653 - 4	979520718	1100	1500	2,4	3 ~ 400 V	F
CB 801 - 4	979520719	4000	1500	8,11	3 ~ 400 V	F
CB 802 - 4	979520720	3000	1500	6,17	3 ~ 400 V	F
CB 401 - 2	979520471	11000	3000	20,4	3 ~ 400 V	F
CB 402 - 2	979520472	5500	3000	10,6	3 ~ 400 V	F
CB 403 - 2	979520473	3000	3000	5,92	3 ~ 400 V	F
CB 501 - 2	979520474	15000	3000	27,6	3 ~ 400 V	F
CB 502 - 2	979520475	7500	3000	14,1	3 ~ 400 V	F
CB 503 - 2	979520476	5500	3000	10,6	3 ~ 400 V	F
CB 651 - 2	979520477	22000	3000	39,1	3 ~ 400 V	F
CB 652 - 2	979520478	18500	3000	33,7	3 ~ 400 V	F
CB 653 - 2	979520479	7500	3000	14,1	3 ~ 400 V	F

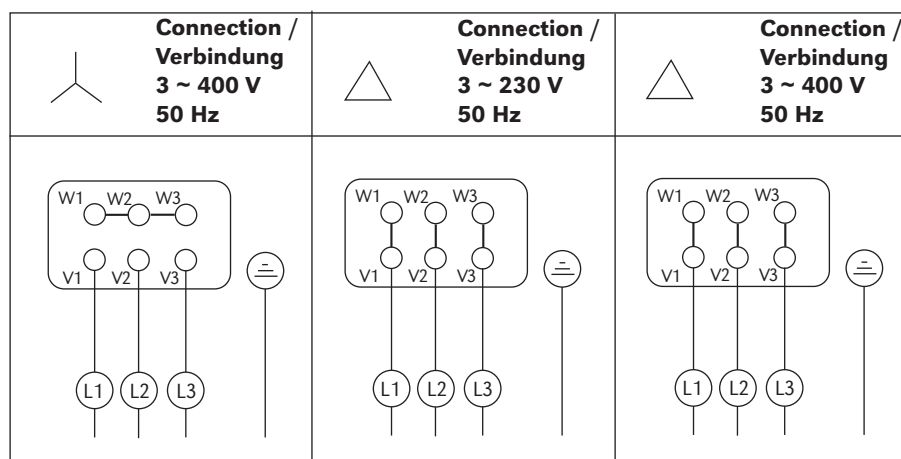



IMPPUMPS

THE HONEST PRODUCT FOR THE HONEST PRICE

GHN



CIRCULATING
PUMP

UMWÄLZPUMPE

PV

PV



Circulating pumps for sanitary water /
Brauchwasser Zirkulationspumpen



Circulating pumps for sanitary water Brauchwasser

TEHNIICAL FEATURES / TECHNISCHE MERKMALE		PV
Connections / Nenweite	DN (")	32
Connection type / Rohranschluss		Flanges / Flansche
Flow max / Förderstrom max	Q (m ³ /h)	14
Pressure max / Förderhöhe	H (m)	6
Pressure rated / Betriebsdruck	PN (bar)	10 / 16
Power max / Leistungsaufnahme max	P (W)	250
Electrical voltage / Elektroanschluss	V	3 ~ 400 V
Degree of protection / Schutzart	IP	54
Regulation / Regelung		no / nien
Media temperature / Temperaturbereich	T(°C)	-10 do +110
Insulating class / Isolationsklasse		F
Casing type / Werkstoffe		Bronze / Bronze
Duble pump / Zwilingspumpe		no / nien
APPLICATIONS / EINSATZGEBIETE		
Heating / Warmwasserheizungen		✓
Cooling / Kaltwasseranlagen		✓
Sanitary water / Brauchwasser		✓
Climate appliances / Klimaanlage		✓
Industry / Industrieanlagen		
Process technique / Verfahrenstechnik		
Condensation / Kondensat		✓
Salt water / Meerwasser		

Pump markings / Typenschlüssel

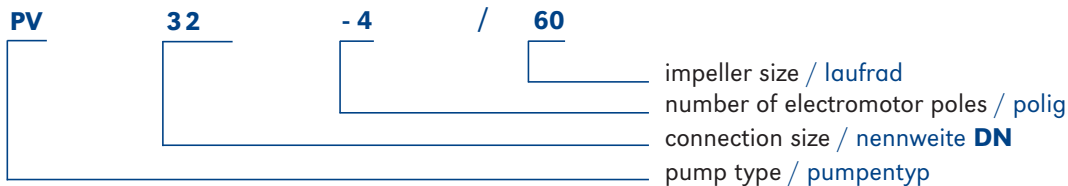

Permitted mounting positions / Einbaumöglichkeiten

PV

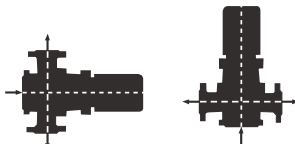

In-line pumps for circulation of sanitary water
Trockenläufer - Inline - Brauchwasserpumpen

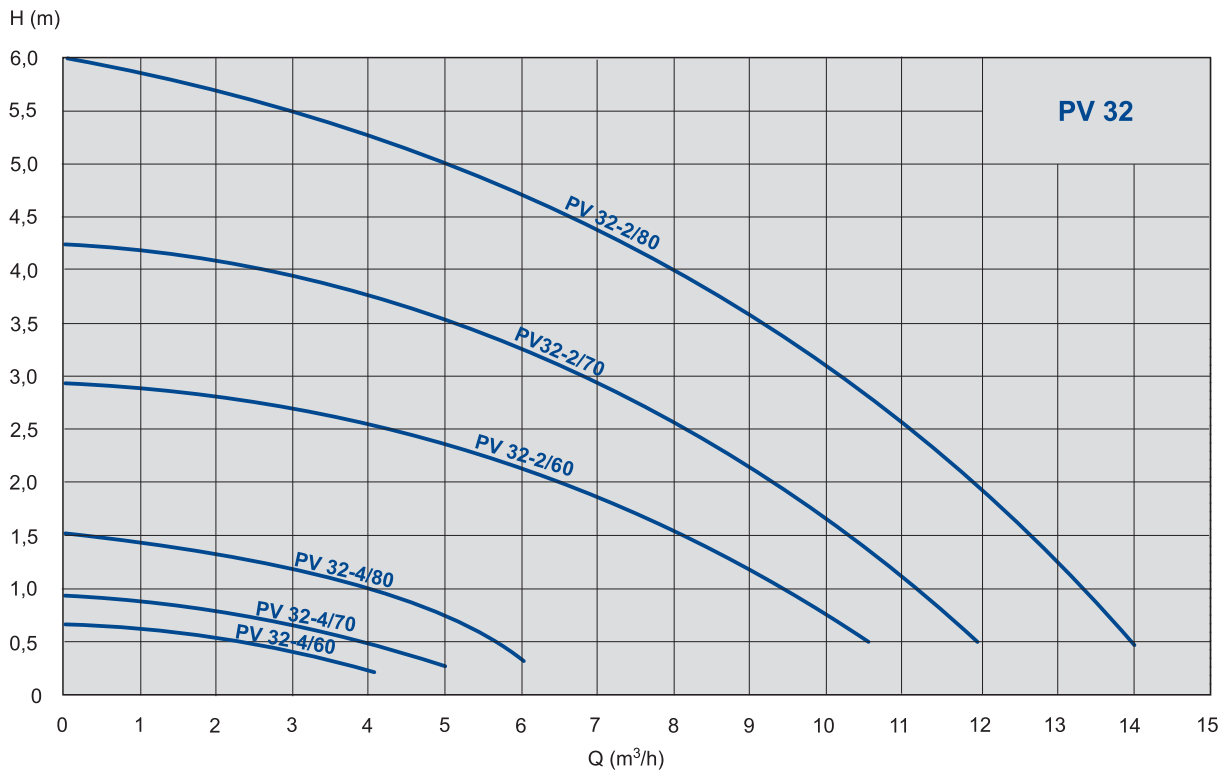
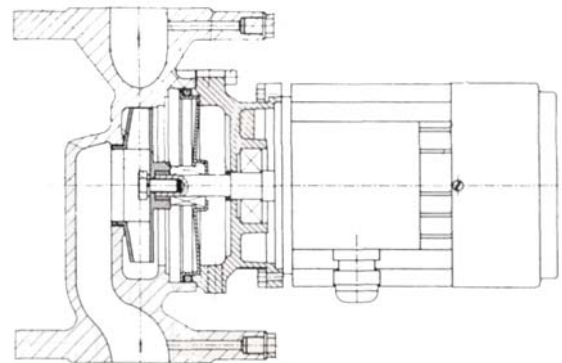
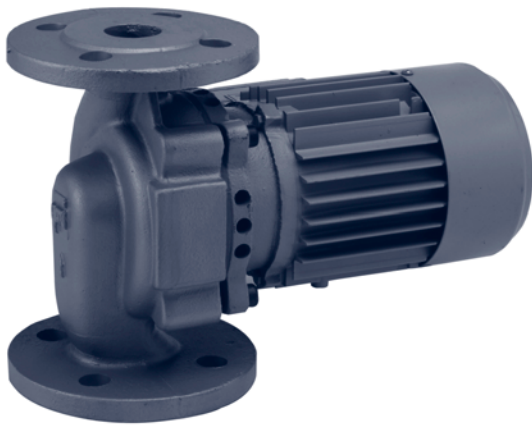

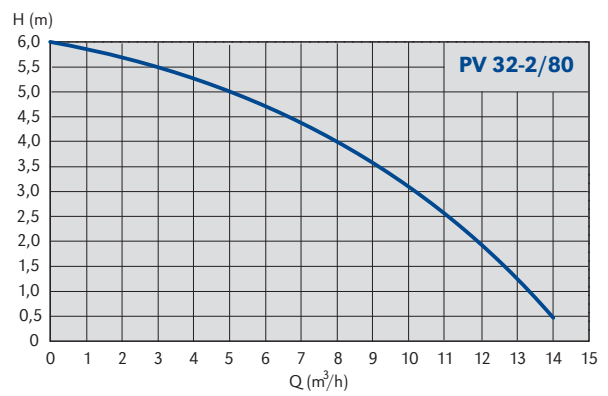
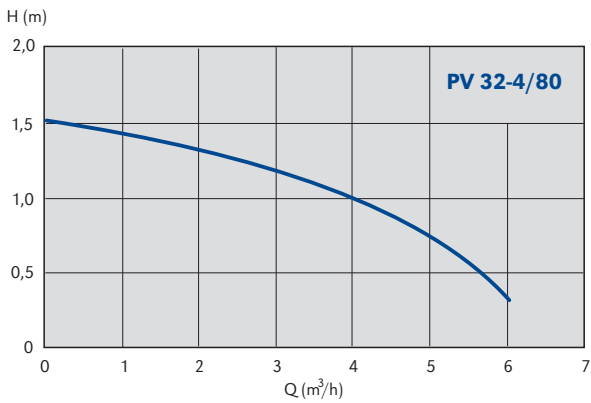
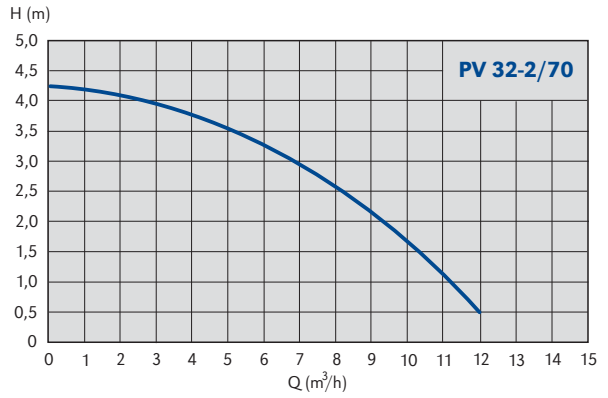
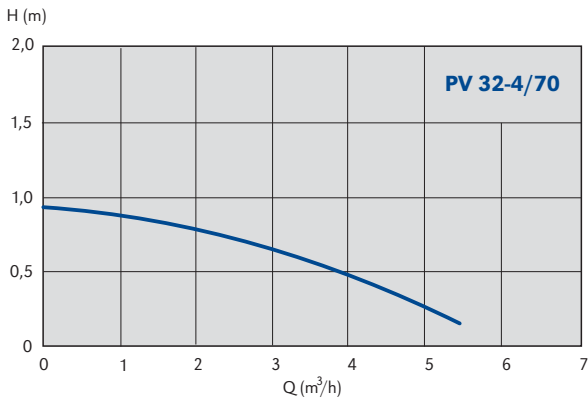
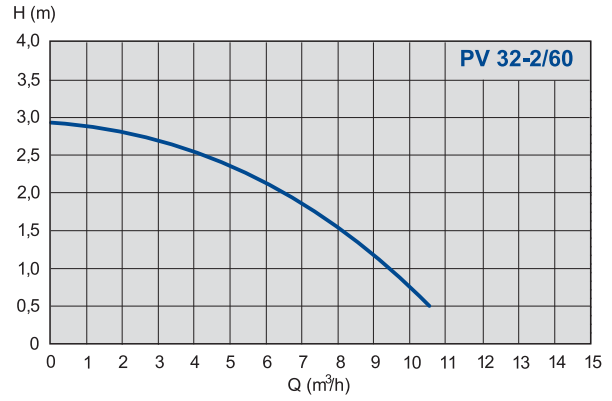
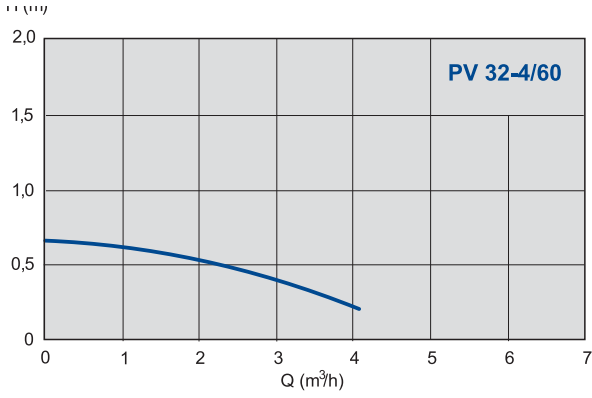

TEHNIICAL DATA / TECHNISCHE DATEN

pump type pumpentyp	code artikelnummer	connection size rohranschluss DN (")	connection type rohranschluss	max. flow durchfluss Q (m ³ /h)	max. pressure druck H (m)	system pressure systemdruck PN (bar)	min. media temp. des mediums T min. °C	max. media temp. des mediums T max. °C	casing type werkstoffe	single-S, double-D einzelne-E, zwillings- bauform-Z	net weight Reinige- wicht (kg)	regulation geregelt yes /ja no /nein	degree of protection schutzart IP
PV 32 - 4 / 60	979521526	DN 32	flanges/flansche	4	0,6	PN 16	-10	110	bronze	S/E	15	no/nein	54
PV 32 - 4 / 70	979521525	DN 32	flanges/flansche	5	0,9	PN 16	-10	110	bronze	S/E	15	no/nein	54
PV 32 - 4 / 80	979521524	DN 32	flanges/flansche	7	1,5	PN 16	-10	110	bronze	S/E	15	no/nein	54
PV 32 - 2 / 60	979521523	DN 32	flanges/flansche	8	3	PN 16	-10	110	bronze	S/E	15	no/nein	54
PV 32 - 2 / 70	979521522	DN 32	flanges/flansche	9,5	4	PN 16	-10	110	bronze	S/E	15	no/nein	54
PV 32 - 2 / 80	979521521	DN 32	flanges/flansche	13	6	PN 16	-10	110	bronze	S/E	15	no/nein	54

DIMENSIONS / MAÖE







pump type pumpentyp	code artikelnummer	length einbaulänge L (mm)	DN	L	L1	a	b	c	d
PV 32 - 4 / 60	979521526	200	32	200	100	277	164,5	70,5	42
PV 32 - 4 / 70	979521525	200	32	200	100	277	164,5	70,5	42
PV 32 - 4 / 80	979521524	200	32	200	100	277	164,5	70,5	42
PV 32 - 2 / 60	979521523	200	32	200	100	277	164,5	70,5	42
PV 32 - 2 / 70	979521522	200	32	200	100	277	164,5	70,5	42
PV 32 - 2 / 80	979521521	200	32	200	100	277	164,5	70,5	42

ELECTRICAL DATA / ELEKTRISCHE DATEN

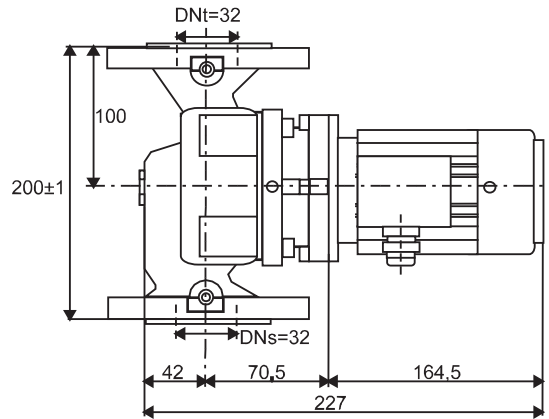

pump type pumpentyp	code artikelnummer	power max. leistungsaufnahme P (W)	speed range drehzahlstufe (min-1)	FLC I nennstrom In (A)	electrical voltage elektroanschluss U (V)	insulating class isoliationsklasse
PV 32 - 4 / 60	979521526	120	1340	0,41	3 ~ 400 V	F
PV 32 - 4 / 70	979521525	120	1340	0,41	3 ~ 400 V	F
PV 32 - 4 / 80	979521524	120	1340	0,41	3 ~ 400 V	F
PV 32 - 2 / 60	979521523	250	2750	0,64	3 ~ 400 V	F
PV 32 - 2 / 70	979521522	250	2750	0,64	3 ~ 400 V	F
PV 32 - 2 / 80	979521521	250	2750	0,64	3 ~ 400 V	F

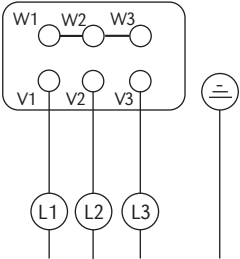
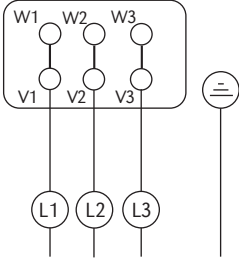
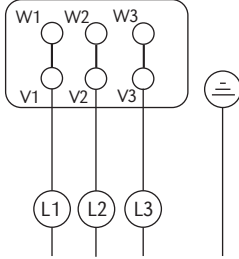

 Connection / Verbindung 3 ~ 400 V 50 Hz	 Connection / Verbindung 3 ~ 230 V 50 Hz	 Connection / Verbindung 3 ~ 400 V 50 Hz
		



IMPPUMPS[®]
Intelligent Motor Pumps

GHNbasic F

CONTACT / KONTAKT

DAMIR POPOVIČ

DIRECTOR / GESCHÄFTSFÜHRUNG

TEL.: +386 (0)1 2806 400

FAX: +386 (0)1 2806 460

E-MAIL: damir.popovic@imp-pumps.com

MATJAŽ KUMP

SALES MANAGER / VERKAUFSLEITUNG

TEL.: +386 (0)1 2806 418

FAX: +386 (0)1 2806 460

GSM: +386 (0)31 670 634

E-MAIL: matjaz.kump@imp-pumps.com

MATJAŽ HRIBAR

REGIONAL SALES MANAGER / GEBIETSVERKAUFSLEITER

TEL.: +386 (0)1 2806 412

FAX: +386 (0)1 2806 460

GSM: +386 (0)41 623 836

E-MAIL: matjaz.hribar@imp-pumps.com

DEJAN STANKOVIĆ

REGIONAL SALES MANAGER / GEBIETSVERKAUFSLEITER

TEL.: +386 (0)1 2806 410

FAX: +386 (0)1 2806 460

GSM: +386 (0)31 687 277

E-MAIL: dejan.stankovic@imp-pumps.com

JANEZ KRAJNER

REGIONAL SALES MANAGER / GEBIETSVERKAUFSLEITER

TEL.: +386 (0)1 2806 401

FAX: +386 (0)1 2806 460

GSM: +49 (0)162 841 73 16, +386 (0)31 697 783

E-MAIL: janez.krajner@imp-pumps.com

SAMI AYARI

REGIONAL SALES MANAGER / GEBIETSVERKAUFSLEITER

TEL.: +386 (0)1 2806 463

FAX: +386 (0)1 2806 460

GSM: +386 (0)51 250 852

E-MAIL: sami.ayari@imp-pumps.com

THE HONEST PRODUCT FOR THE HONEST PRICE



IMPPUMPS®

IMP PUMPS, d.o.o.

SI - 1218 Komenda

info@imp-pumps.com

www.imp-pumps.com

Your IMP Pumps representative / Ihr Ansprechpartner