



**IT**

**Istruzioni per l'installazione, l'uso e la  
manutenzione**

**USA**

**Instructions for Installation, Use and  
Maintenance**

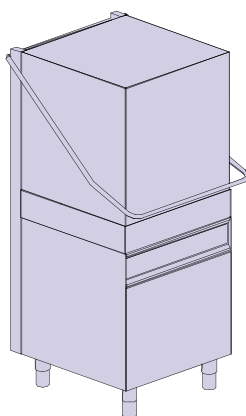

**HOOD-TYPE  
D-18**





Thank you for choosing our appliance.

The installation, use and maintenance instructions given in this manual have been prepared to ensure the long life and correct operation of your appliance.

Follow these instructions carefully.

We have designed and manufactured this appliance according to the latest technological developments. Now, it is in your care.

Your satisfaction is our greatest reward.

SUMMARY	Page
<b>IMPORTANT INFORMATION</b>	<b>20</b>
<b>1. SERIAL NUMBER DATA</b>	<b>22</b>
<b>INSTALLER SECTION</b>	
<b>2. MACHINE INSTALLATION</b>	<b>23</b>
2.1 Receiving the machine	23
2.2 Water connections	23
2.3 Electrical connection	24
2.4 Temperature adjustment	24
2.5 Rinse aid dispenser operation	24
<b>3. DETERGENT DISPENSER INSTALLATION</b>	<b>26</b>
3.1 Electrical connection	26
3.2 Water connection	26
3.3 Dispensing the detergent	26
<b>4. TECHNICAL DATA AND USEFUL INFORMATION ON PUMPS</b>	<b>26</b>
4.1 Drain pump (optional)	26
<b>USER SECTION</b>	
<b>5. CONTROL PANEL AND RELATIVE SYMBOLS</b>	<b>27</b>
<b>6. OPERATION</b>	<b>27</b>
6.1 Cutlery and crockery loading	27
6.2 Detergent use	28
6.3 Rinse aid use	28
6.4 Compliance with hygiene regulations, H.A.C.C.P. and NSF	29
6.5 Drain pump (optional)	29
<b>7. MAINTENANCE</b>	<b>29</b>
7.1 Routine maintenance	29
7.2 Extraordinary maintenance	29
<b>8. THE ENVIRONMENT</b>	<b>30</b>
8.1 Packing	30
8.2 Disposal	30
<b>9. ECOLOGICAL ASPECTS</b>	<b>30</b>
9.1 Recommendations for optimal use of energy, water and additives	30
<b>10. TROUBLESHOOTING</b>	<b>31</b>



**READ THE INSTRUCTIONS CAREFULLY BEFORE INSTALLING THE MACHINE.**



**WARNING: FAILURE TO COMPLY (EVEN PARTIALLY) WITH THE RULES GIVEN IN THIS MANUAL WILL INVALIDATE THE PRODUCT WARRANTY AND RELIEVES THE MANUFACTURER OF ANY RESPONSIBILITY.**



## IMPORTANT INFORMATION

Always keep this instruction manual near the dishwasher for future consultation. If the appliance is sold or transferred to another User, make sure this manual always remains with the machine to enable the new owner to be informed about operation of the appliance and the relative warnings. The dishwasher shall be installed in accordance with local codes, or in the absence of local codes, installed in accordance with the applicable requirements in the National Electrical Code, NFPA 70, Canadian Electrical Code (CEC), Part 1, CSA C22.1, and Standard for Ventilation Control and Fire Protection of Commercial Cooking Operations, NFPA 96.

These warnings are provided to safeguard the user in conformity with technical standards UL 921 and NSF.

They must be read carefully before installation and use of the dishwasher.

- The electrical and plumbing connections for installing the dishwasher must only be made by qualified and authorized person who will comply with all available Federal, State, and Local Health, Electrical, Plumbing and Safety codes.
- This dishwasher must be used by adults only. This is a professional machine to be used by qualified personnel, and installed and repaired exclusively by a qualified technical assistance service. The Manufacturer declines any responsibility for improper use, maintenance or repair.
- The appliance is not to be used by children or persons with reduced physical, sensory or mental capabilities, or lack of experience and knowledge, unless they have been given supervision or instruction.
- Children being supervised not to play with the appliance.
- Accompany the door in opening and closing.
- Make sure the dishwasher is not resting on the electrical feed cables or the filling and emptying pipes, otherwise adjust the feet of the appliance and make sure that it is perfectly level.
- Do not use the appliance or any part of it as a stepladder or means of support as it has been designed exclusively to bear the weight of the dishrack containing dishes to be washed.
- **The dishwasher is designed only and exclusively for washing plates, glasses and crockery in general with residuals of foodstuffs. Never wash any unspecified item, anything overly fragile or unable to withstand the washing process. Do not use acidic corrosive chemical products or alkaline and solvents or chlorine based detergents.**
- Never open the dishwasher door and never switch it off during operation. Always switch it off before accessing the inside. The dishwasher has a safety device which immediately stops it if the door is accidentally opened, preventing water spillage.
- **This machine must be disconnected from the main electrical supply after use at the end of the day and for any service/maintenance operation. Switch off the main**

**switch located on the wall, which shall be installed by a professional installer. Shut the water supply valve(s). Disregarding the aforesaid prescriptions is a serious misuse and can cause damages and injures to property an people, and will relieve the manufacturer from whatever liability.**

- Under no circumstances should the user attempt to carry out repairs. Contact a qualified and authorized technician.
- Technical assistance for this dishwasher must only be carried out by qualified and authorized operators.

**Note: Only use original replacement parts. Otherwise the product warranty is invalidated and the manufacturer is no longer responsible.**

- **Do not use old load pipe, but only new ones.**
- Some important rules must be followed for using this appliance:
  - 1) never touch the appliance with wet hands or feet
  - 2) never use the appliance when barefoot
  - 3) do not install the appliance in places exposed to water sprays.
- Do not dip bare hands into water containing detergent. If this should occur, wash them immediately with plenty of water.
- Only follow the instructions given in the manufacturer's booklet for cleaning operations (chap. 7).
- Minimum room temperature for operation is 50°F (10°C).
- Do not use water to put out fires on electrical parts.
- Do not clog the intake or dissipation grids.
- Only qualified personnel can access the control panel after power is switched off.
- The machine has an IPX3 rating of protection against accidental splashes of water. It is not protected against pressurized jets of water, so it is recommended that pressure cleaning systems not be used.

**NOTICE: This machine must be operated with an automatic detergent dosing pump and, if applicable, an automatic chemical sanitizer dosing pump, including a visual means to verify that detergents and sanitizers are delivered or a visual or audible alarm to signal if detergents and sanitizers are not available for delivery to the respective washing and sanitizing systems. Please see instructions for electrical and plumbing connections located in this manual.**

**N.B.: The Manufacturer declines any responsible for damage or injury caused by failure to follow the above rules.**



**IMPORTANT: WAIT AT LEAST 10 MINUTES AFTER THE MACHINE HAS BEEN SWITCHED OFF BEFORE CLEANING INSIDE IT.**

**DO NOT INSERT HANDS AND/OR TOUCH THE PARTS AT THE BOTTOM OF THE TANK WITH THE MACHINE ON AND/OR HOT.**

# 1. SERIAL NUMBER DATA

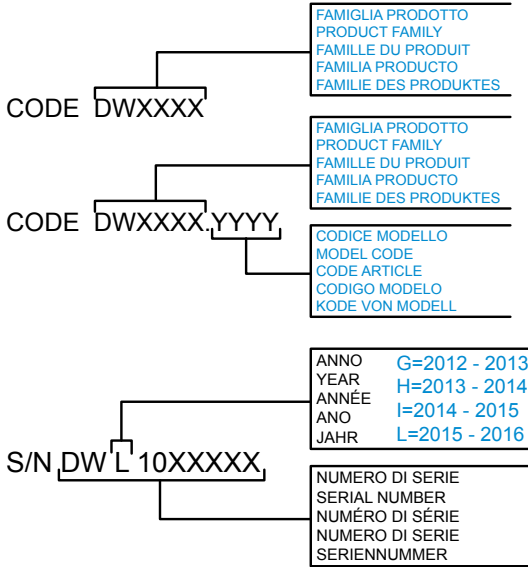

**A** → 400V 3N 50HZ  
**B** → xxxkW  
**C** → IPXX  
**D** → ANNO PROD.: 2016  
**E** → xxxW  
**F** → xxA  
**G** → 200-500 kPa

Code DWXXXX.YYYY CL/Part  
 Model DESCRIPTION  
 S/N DWL10XXXXXX Type .....  
 400V 3N 50HZ  
 xxxkW  
 IPXX  
 Pressione dinamica alimentazione idrica / Pression dynamique arrivée d'eau / Dynamic pressure water supply / Fließdruck Wasserzulauf  
 200-500 kPa  
 ANNO PROD.: 2016  
 xxA  
 Pressione dinamica vapore saturo / Pression dynamique vapeur saturée / Saturated steam dynamic pressure / Dynamischer Dampfdruck  
 xxxkPa  
 Temperatura massima acqua in ingresso / Temperature max eau à l'entrée / Maximum water-infeed temperature / Maximale Zulaufwassertemperatur  
 xx°C  
 MADE IN ITALY

Model [Barcode] S/N [Barcode]

- A** Power source
- B** Total power installed
- C** Envelope protection degree
- D** Total electricity absorption
- E** Total motors power
- F** Electrical protection index
- G** Dynamic pressure

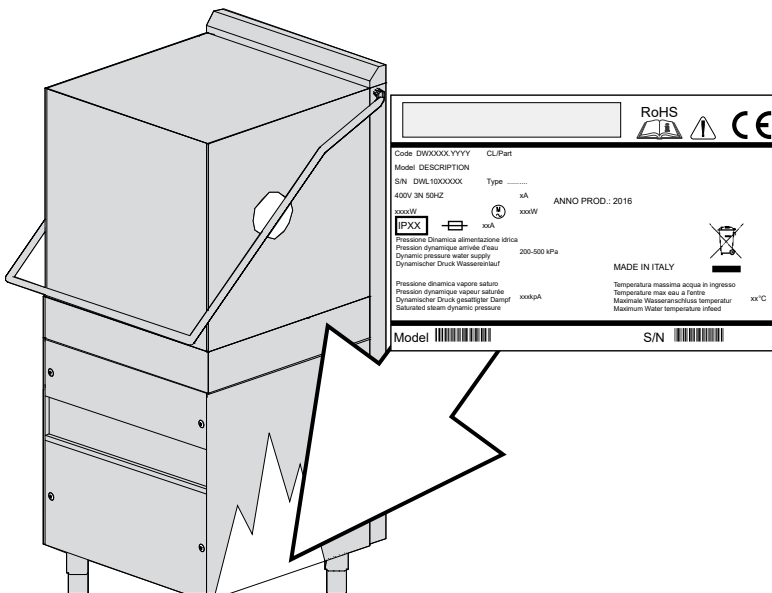

**ATTENTION:**

At the end of installation make sure to remove the parts of this booklet relevant to the installer, for future consultation.

**2. MACHINE INSTALLATION**

**2.1 Receiving the machine**

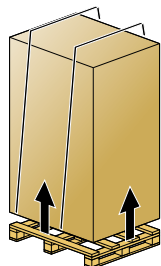

After unpacking, make sure the machine has not been damaged during transportation. If so, do notify the seller immediately about the problem. If the damage might question the machine safety, do not install it.

**Double check the firm tightness of all hose-clamps on piping, nuts, bolts and electrical connection that might have come loose during transportation, to prevent water dripping leakages, or other damages, during the machine operation.**

See chap. 8 for disposing the packing material.

**2.2 Water connections**

Connect the machine's water supply with an interrupt valve capable of quickly and completely shutting off water intake. The Water system must have characteristics between the parameters specified in table 1.

Pressure table	Min.	Max.
	Psi (kPa)	Psi (kPa)
Static Pressure	30 (200)	60 (400)
Dynamic Pressure	30 (200)	50 (350)
Water Hardness	2°f	10°f

table 1

H <sub>2</sub> O supply temperature table
H <sub>2</sub> O Hot
140°F ≤ t ≤ 150°F
60°C ≤ t ≤ 65.5°C

table 2

If it is less than 30 Psi dynamic pressure (200kPa) a pressure pump must be installed to guarantee optimal machine operation. If, however, the water supply pressure is greater than 60 Psi (400 kPa), a pressure reducing device must be installed. For water with average hardness greater than 10°f, a water softener must be used. This will result in cleaner dishes and longer life of the appliance.

Each machine is provided with a rubber tube with a 3/4" threaded attachment for water filling.

It is advisable to connect the hose to a water supply not above 150°F (65,5°C), if connected to the hot water.

Connect the emptying tube, supplied with the appliance, to the union elbow located under the tub so that water flows freely. If it is not possible to empty the water at a level lower than the drain of the appliance, it is advisable to install an emptying pump, which can be provided by request.

The emptying tube should always be connected to a siphon to prevent odor back-up from the screen.

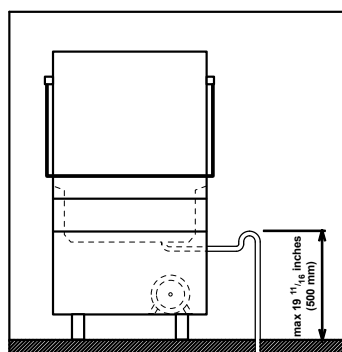

pict. 1



## 2.3 Electrical connection

The electrical connection must be made according to current technical standards.

Ensure that the mains voltage corresponds to the value given on the machine dataplate.

Install a suitable omnipolar thermal magnetic circuit breaker, dimensioned according to absorption, with opening contact, in according to current standards.

This circuit breaker must be exclusively used for this purpose and installed in the immediate vicinity.

The machine must be turned off with this switch.

Make sure that the electrical systems are suitably earthed.

On the back of the appliance there is a terminal marked with the symbol  which is provided for equipotential connection between different appliances. The special dataplate gives the max. power value in watts (W), amperes (A) and fuse, for dimensioning of the line, cable and switches.



The dealer/importer/installer must adapt the power cable insulation class according to the work environment, in conformity with current Technical Standards.

**Cable characteristics:** Use copper cables only, correctly dimensioned for the amperage indicated on the machine and made to operate at minimum 167°F (75°C).

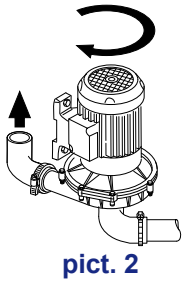

**Warning:** some versions of this machine can dissipate more than 10mA to earth.

If the machine is fitted with a three-phase pump, check correct motor rotation (direction of arrows on the casing - see pict. 2). The problem does not exist if the pump is single-phase (standard).

## 2.4 Temperature adjustment

If necessary, the water temperature of the wash and rinse cycles can be adjusted by means the respective thermostats.

The recommended temperatures are 160°F (71°C) for the wash cycle (tub) and 185°F (85°C) for the rinse cycle (boiler).

## 2.5 Rinse aid dispenser operation

### Technical characteristics:

**Operation:** it utilizes the wash pump starting pressure and the water circuit pressure in the rinse phase. Min. water pressure 30 Psi (200 kPa).

### Water connection:

- 1) Connect the dispenser tube fitting **A** to the pump, by means of the rubber tube installed in the appliance (pump pressure).
- 2) Connect the small black rubber tube by the brass delivery fitting **B** to the connection near the boiler (injector).
- 3) Make sure that the green product suction tube is inserted on the special fitting **C** and that the small filter and the ballast are inserted in the rinse aid tank.

**Priming:** To carry out priming, start the machine and carry out a few complete wash and rinse cycles. To speed up restoration press the adjustment screw **D** during the wash cycle and open the hood; press pin **D** again and close the hood; press pin **D** again and close the hood for a few seconds, open the hood again and press pin **D** again and close the hood. Repeat this operation until the green tube is completely filled.

**Adjustment:** With every rinse the dispenser draws a quantity of rinse aid adjustable from 0 to 2 cubic inches (from 0 to 4 cm<sup>3</sup>), equivalent to a length of 0 to 11 inches (from 0 to 30 cm).

Min. delivery is obtained by turning the adjustment screw **D** clockwise all the way, whereas max. delivery is obtained by turning the adjustment screw approx. 20 turns anticlockwise.

For the right amount of product see the paragraph **Rinse aid use**.

**Note:** for every turn of the screw the amount of rinse aid drawn in the tube varies by 5/8 inches (1,6 cm) equal to 13/16 cubic inches/run (0,2 cm<sup>3</sup>/turn - approx 0,01 ounces/run - 0,21 gr/turn with rinse aid density of 0,60 ounces/cubic inches - 1,05 g/cm<sup>3</sup>). The rinse aid dispenser cannot work correctly if the difference in level between the bottom of the machine and the tank is more than 31 inches (80 cm).

THE DISPENSERS ARE PRESET FOR DRAWING 2" (5 cm) FOLLOWING A FUNCTIONAL CHECK DURING THE TESTING PHASE. THIS VALUE MUST ALWAYS BE MODIFIED ACCORDING TO THE TYPE OF RINSE AID AND THE HARDNESS OF THE WATER.



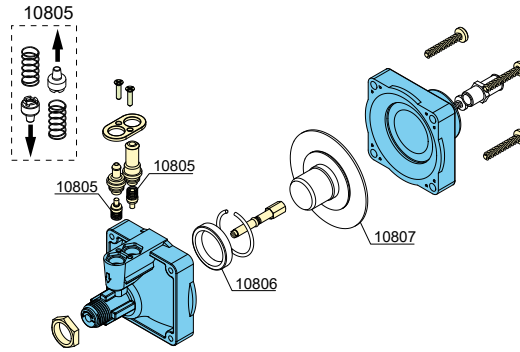
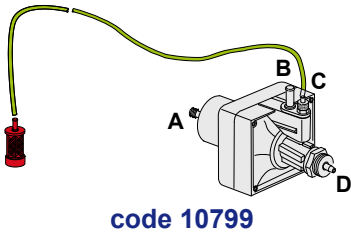

PROBLEMS	CAUSES AND SOLUTIONS
Water exits from the rinse aid suction tube	The suction valves 10805 and delivery do not seal due to foreign bodies in the closing seats. Clean the valves 10805, check that the rinse aid suction filter is present, and filter the water entering the dishwasher
The dispenser does not draw rinse aid	a) The delivery valve 10805 does not seal due to foreign bodies in the closing seats. Clean the valve 10805, check that the rinse aid suction filter is present and filter the water entering the dishwasher
	b) The piston seal 10806 does not hold because it is damaged. Replace the seal 10806 with an original
	c) Check the diaphragm 10807

### 3. DETERGENT DISPENSER INSTALLATION

#### 3.1 Electrical connection

Follow the wiring diagram attached to the machine.

#### 3.2 Water connection

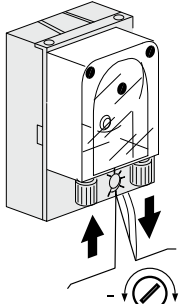

- Remove the cap from the hole and fit the delivery connection.
- Correctly mount the injector **C** using the appropriate fixtures.
- Connect the suction tube to the suction attachment of the dispenser (see pict. 4 - point **A**).
- Connect the delivery tube to the other attachment of the dispenser, and the delivery fitting (see pict. 4 point **B**).
- Insert the suction tube with filter in the detergent tank.
- Prime the detergent and proceed to dispense.

#### 3.3 Dispensing the detergent

The detergent dispenser capacity can be adjusted using a screwdriver as shown in picture 3.

Every  $\frac{13}{16}$  (2 cm) of product drawn into the tube corresponds to  $\frac{1}{64}$  cubic inches (0,25 cm<sup>3</sup>) equivalent to 0,01 oz (0.3 g - th a concentration of  $\frac{1}{16}$  oz/cubic inches - 1,2g/cm<sup>3</sup>). For proper dispensing see paragraph 6.2.

fig. 3

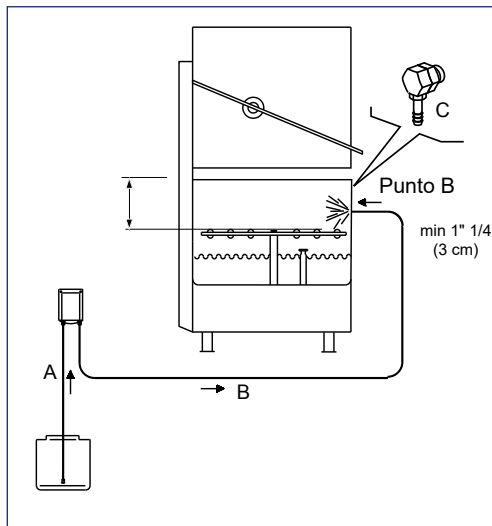

**IMPORTANT:** DO NOT INVERT THE TUBES IN THE PRODUCTS; IF THIS OCCURS IT WOULD RUIN THE METERING PUMPS AND COMPROMISE DISHWASHER OPERATION.

CONNECTION DIAGRAM

pict. 4

### 4. TECHNICAL DATA AND USEFUL INFORMATION ON PUMPS

#### 4.1 Drain pump (optional)

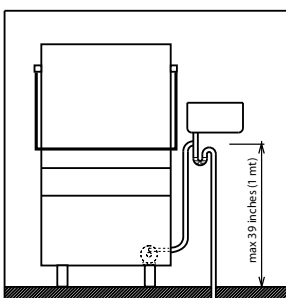

pict. 5

When installing, pay particular attention to the position of the emptying tube (see pict. 5).

Max. drain height <39 inches (<1mt), there must be a trap downstream of the drain.

For the electrical connection see the wiring diagram notes.

## 5. CONTROL PANEL AND RELATIVE SYMBOLS

### CONTROLS

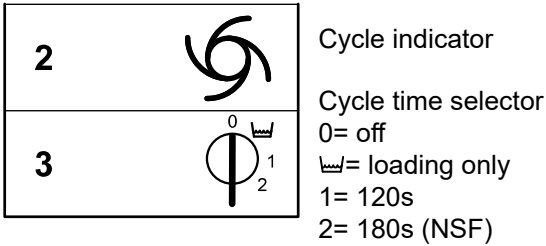

### INDICATORS

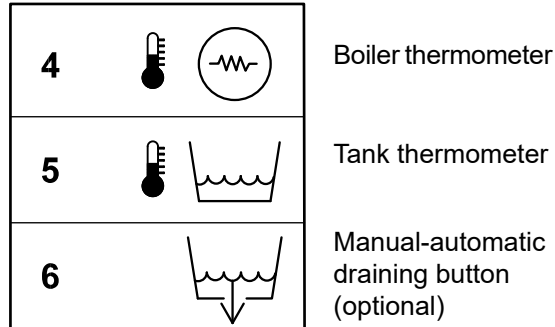

## 6. OPERATION

- Insert the overflow pipe in the special seat inside the tank.  
Make sure all the filters are properly fitted in their seats. The filters must be cleaned every 40-50 wash cycles and whenever necessary.  
**Do not operate the machine without filters, and in particular the pump suction filters.**
- Open the water valve.
- Turn on the main wall switch and put the selector on (it is not a total disconnecting switch).
- Insert the special green rinse aid dispenser tube in the liquid rinse aid container and check that the quantity is sufficient for the daily requirement.
- Make sure that the selector is on .
- Using the handle, lower the machine hood and the tank filling phase automatically starts. The automatic electric detergent dispenser supplies to the dosage of the detergent.
- After filling, the machine automatically starts the heating phase.
- The machine will be ready for washing only when the boiler thermometer **4** and tank thermometer **5** indicate that the required temperatures have been reached, which are 185°F (80-85°C) for boiler and 160°F (71°C) for the tank.
- Select the wash time with the selector **3**.  
Pos. 1= short  
Pos. 2= long (NSF)  
This in machines equipped with thermostop, in order to guarantee the exact rinse temperature, the washing time can increase to allow the boiler water temperature to reach the set temperature (185°F / 80°-85°C)
- Insert the basket with dishes or various articles to be washed and close the hood (see par. **6.1**). The wash cycle starts automatically, immediately followed by the rinse cycle. The cycle is signalled by the indicator **2**.
- The cycle is finished when the indicator goes off.
- The appliance is ready for another cycle.

**Note:** It is advisable to change the tank water, by means of another filling, at least every 40-50 washes or twice a day. Clean the machine at the end of the day (see chap. **7 Maintenance**).

Position the selector **3** on the position **0**.

Switch the machine off and close the water valve.

**N.B.:** the first cycle carried out after changing the time with the mechanical timer will not yet be like the one set previously: the timer requires a complete washing cycle in order to realign the cams according to the set time. Selecting the cycle won't start by closing the hood.

### 6.1 Cutlery and crockery loading

Before cutlery and crockery loading in the machine, coarsely clean them from the leftover food.

It isn't necessary to rinse the cutlery and crockery under water.

**ATTENTION: Do not wash articles polluted with petrol, paint, chips of steel or iron, ash, sand, wax, lubricant grease. These substances damage the machine. Do not wash fragile objects or material not resistant to the washing process.**

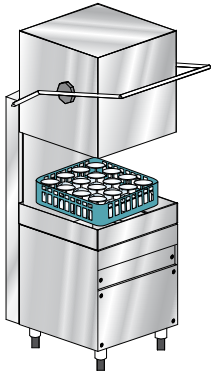

Note the following recommendations:

- Crockery and cutlery should not be inserted inside one another, covering each other.
- Place the crockery in order to all surfaces can be reached by water; otherwise the dishes are not washed.
- Make sure all the crockery are in a stable position and that the hollow containers don't overturn (cups, glasses, bowls, etc.) .
- Place in the rack all the hollow containers such as cups, glass, etc. **upside-down**.
- Place the crockery with deep hollow with upper face downwards, so that water can flow out.
- Make sure the smaller crockery do not fall from the rack.
- Check all the wash arms runs freely and they are not blocked by too tall or too prominent crockery. Eventually, run a manual rotation of the arms to check it.

Some foods, such as carrots, tomatoes, and others, may contain some natural dyes substances, that in large amounts, can alter the crockery and plastic parts colors.

Any discoloration does not mean that the plastic is not heat resistant.

### Crockery and cutlery not suitable for dishwasher

Not suitable for dishwasher:

- Wooden crockery and cutlery or with wooden parts; water at high temperature causes deformation to wood. Also the adhesives used are not suitable for treatment in the dishwasher; a consequence could be the handles detachment.
- Crafts, precious vases or decorated glasses.
- Not heat-resistant plastic crockery.
- Copper, brass, pewter or aluminum objects: they may become discolored or opaque.
- The decorations on glass, after a certain number of washes, can lose gloss.
- Fragile glasses or crystal items, if often washed, can become opaque.

We recommend to buy exclusively crockery and cutlery suitable for dishwashing.

After several washes, the glass can become opaque.

**It is mandatory to repeat the washing cycle if at the end of the cycle the crockery are not well clean or if there are washing residues (glasses, cups, bowls, etc. with liquid inside).**

## 6.2 Detergent use



The detergent shall be the NO FOAM type, suitable for industrial dishwashers. The use of good quality liquid detergents is recommended.

Put the detergent directly in the tub. Follow the manufacturer's recommendations for chemical dosage. By request, the dishwasher can be equipped with an electric detergent dispenser .

$\frac{3}{8}$  inches (1cm) of the product drawn into the tube is equal to about  $\frac{3}{32}$  Dramme (0,15g). A correct amount of detergent is very important for a successful wash.

This machine must be operated with an automatic detergent dosing pump. Verify the correct operation by checking the detergent flow in the transparent suction hose from the detergent canister. Make the check during the tank filling or rinse phase.

## 6.3 Rinse aid use



The machine is equipped with a rinse aid dispenser. The machine automatically draws the product. The amount dispensed can be regulated by operating the fine-adjustment screw on the dispenser. Reduce the amount by turning the screw clockwise, increase by turning it anticlockwise.

The recommended amount is  $\frac{7}{8}$  -  $1 \frac{15}{16}$  inches (2-5cm) of product measured on the suction tube.

$\frac{3}{8}$  inches (1cm) of the product drawn into the tube is equal to about  $\frac{1}{16}$  Dramme (0,13g). A correct amount of rinse aid is very important for a quick and clean drying.

**N.B.:** too much product, or foam, reduces the efficiency of the wash pump.

### 6.4 Compliance with hygiene regulations, H.A.C.C.P. and NSF

- The machines are equipped with a temperature indicator to indicate the boiler and tank temperature. Wait until the set temperatures are fully reached: at least 160°F for the washing tub and 185°F for the rinse. Verify that the pressure of the rinsing is between 15 and 25 Psi.
- Remove solids from the crockery, not clog filters, nozzles and pipes.
- Drain the wash tanks and clean the filters at least twice a day.
- Check that detergent and rinse aid dosing is correct (as recommended by the supplier). Before starting the machine make sure the amount of chemicals in the tanks is sufficient for the daily requirement.
- Keep the tables surfaces clean.
- Remove the basket from the machine with clean hands or gloves, not to contaminate the cutlery.
- Do not dry or polish the crockery with unsterile cloths, brushes or rags.

### 6.5 Drain pump (optional)

To empty the tank: remove the overflow and leave the hood open, then press the key **6** to start the automatic total emptying time.

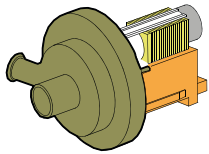

For another load, insert the overflow and switch the machine on again. During the wash-rinse cycle the excess water is automatically discharged.

## 7. MAINTENANCE



### 7.1 Routine maintenance

**ATTENTION: The machine is not protected against pressure water jets, therefore do not use such cleaning systems on the cabinet.**

**It is also advisable to contact cleaning product dealers for detailed information on methods and products for periodical sanitizing of the machine.**

**Do not use bleach or chlorine-based detergents to clean the dishwasher.**

Perfect machine operation depends on careful cleaning, which must be carried out at least once a day, in the following way:

- Turn off the ON/OFF switch to **0**.
- Turn off the water valve.
- Drain the water removing the overflow pipe.  
For appliances provided with emptying pump, see par. **6.5**.
- Remove the filters and clean them with a brush under a strong jet of water.
- Remove the impellers by undoing the fixing screws and carefully clean the nozzles, wash arms, and rinse under running water.
- Refit all the parts and arrange the impellers in their seats, securing them with the relative fixing screw.
- Carefully clean the tank; do not use chlorine-based detergents.
- At the end of the day it is advisable to leave the machine hood open.



**Note: It is advisable to change the tank water, by new filling, at least every 40-50 washes or twice a day. Do not use metal scouring pads and/or corrosive products for cleaning the dishwasher.**

### 7.2 Extraordinary maintenance



Once or twice a year have the machine checked by a qualified technician, to:

- 1 Clean the solenoid valve filter;
- 2 Remove scale from the heating elements;
- 3 Check the tightness of seals;
- 4 Check the integrity and/or wear of components;
- 5 Check the functionality of the dispensers.
- 6 Have the electrical connection terminals tightened at least once a year by Technical Assistance.

## 8. THE ENVIRONMENT



### 8.1 Packing

The packing consists of the following:

- a wooden pallet
- a nylon (LDPE) bag
- a multilayer cardboard box
- polystyrene foam (PS)
- polypropylene (PP) straps.

**Please dispose of the materials listed above, according to the current regulations.**

### 8.2 Disposal



The machine must be disposed of according to current regulations: contact the Municipalized Firm responsible for collection of urban solid waste.

Before disposing of the appliance, disconnect all water and electrical connections.

Cut the electrical cable in such a way as to prevent further use.

As all metal parts are stainless steel, they are therefore recyclable.

Recyclable plastic parts are identified by the plastic symbol.

## 9. ECOLOGICAL ASPECTS

### 9.1 Recommendations for optimal use of energy, water and additives



Use the machine fully loaded when possible

This shall prevent detergent, rinse aid, water and energy waste.

Detergent and rinse-aid

Use detergent and rinse-aid chemicals with high biodegradability, to respect the environment best. Verify the proper dosage in relation to water hardness at least once a year. Excess of product pollutes rivers and seas while an insufficient dosing will cause unsatisfactory dish washing and/or hygiene.

Tank and boiler temperatures

The tank and boiler temperatures are set by the manufacturer in order to obtain the best washing results with detergents on the market. These may be re-set by the installer according to your detergent (see paragraph 2.5).

Cleaning off

Carefully remove solids off the kitchenware using water at room temperature so as to make removal of animal fats easier. To remove encrusted matter, soaking in hot water is recommended.

Notes:

Wash the objects as soon as possible in order to prevent the deposits from drying and jeopardizing the effectiveness of the washing. To get an efficient wash, it is advisable to regularly clean and maintain the machine (see chap. 7).

**Disregarding the points listed above and any information contained in this manual can cause energy, water and detergent waste with a subsequent increase in running costs and/or performance reduction.**



10. TROUBLESHOOTING

Type of problem	Possible causes	Cure
The machine does not turn on	Main switch not ON.	Turn switch ON.
The machine does not load water.	Water valve shut.	Open the water valve.
	The spray arm nozzles or the solenoid filter are clogged and/or caked with lime deposits	Clean the rinsing arm nozzles, the pipes and the filter. Check that the water hardness is <10°f. Equip the machine with an external water softener
	Faulty pressure switch	Replace the pressure switch (call the Technical Assistance service)
Washing results are unsatisfactory.	The washing nozzles are obstructed or the rack does not rotate.	Unscrew and clean the nozzles and the rotation shaft carefully, refit them correctly in their seats
	Filters are dirty.	Remove filters, clean with brush under a jet of water and replace in original position.
	Presence of foam	Use a non-foaming detergent or reduce the amount of that used. Check the rinse aid dispenser
	Fats or starches are not removed	Detergent concentration too low
	Check the tank temperature (it must be about 160°F - 71°C)	Adjust the thermostat or check correct heating element operation
	Length of washing cycle inadequate for type of grime build-up	Choose a longer cycle if possible, otherwise repeat wash cycle
	Wash water too dirty	Empty water from the tank, clean filters; refill the tank and correctly refit the filters
Glasses or dishes are not completely dried	Insufficient rinse aid	Increase the amount of rinse aid by turning the screw on the dispenser (see paragraph <a href="#">Rinse aid use</a> )
	The rack is unsuitable for the glasses and dishes	Use a suitable rack enabling the dishes to be tilted so water can run off
	The dishes have been too long in the tank	As soon as the wash cycle is finished, pull the rack out immediately, allowing the air to dry the glasses and dishes more quickly
	Rinse water temperature is less than 185°F (85°C)	Check the temperature of the booster thermostat. Call the Technical Assistance service to adjust
	Surface of dishes and glasses too rough or porous for material wear.	Replace type of dishes and glasses used
Streaks and spots on glasses and dishes.	Too much rinse-aid chemical.	Reduce the rinse aid amount by turning the micrometric dispenser screw (see par <a href="#">Rinse aid use</a> )
	Too hard water.	Check the water quality. Water must not exceed 10°f in hardness. Equip the machine with an external water softener
	Salt present in dishwasher tub	Thoroughly clean and rinse the appliance, and avoid spilling salt when filling the container.
The machine suddenly stops during the cycle	The machine is connected to an overloaded circuit	Connect the machine separately (call the Technical Assistance service)
	A safety device has been activated	Check safety devices (call the Technical Assistance service)
During wash cycle the machine stops and draws water	Water from the previous day has not been replaced	Empty the tank and refill it
	Faulty pressure switch	Have the Technical Assistance service check the thermostat and the pressure switch
	The overflow tube is incorrectly positioned	Remove the overflow tube and correctly reposition it

**Note For any other problems, contact the Technical Assistance service.**  
**The manufacturer reserves the right to alter the technical characteristics without prior notice.**