

AGES 14+

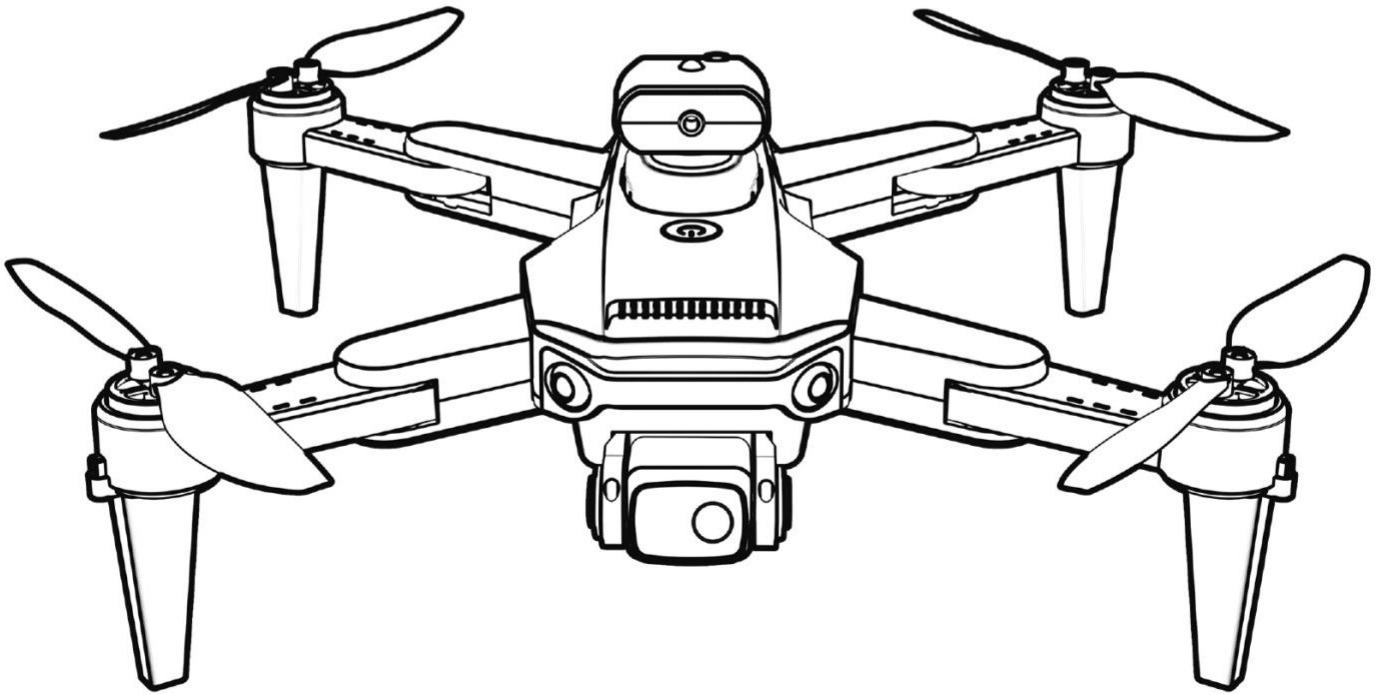

Phantom 9 PRO 4K GPS



Gesture
Photography

GPS
Precise
Positioning



Photo/video

Smart Image
Following

One Key Return

Automatic Beauty

FPV

Optical flow positioning

Phone App Rc

Longer Battery Life

Gesture Control

HD pixel

Gesture
Video

Headless Mode

Video Following

Speed Adjustable

Trajectory Flight

One Key Take-off

One Key Landing

⚠WARNING

In order to ensure the electromagnetic environment requirements for aeronautical radio navigation stations, it is forbidden to use various remote control and drones within 10 km on both sides of the airport runway center line, 20 km from both ends of the runway, on civil aviation's air routes or air line. During the period of the management of radio operation orders by the relevant state departments, the various remote control and drones shall be stopped as required.

DISCLAIMER AND SAFETY INSTRUCTIONS

In order to make it easier and safer to use this product, please read all the contents of this manual carefully before using this product, and save this manual for future reference.

DISCLAIMER

1. In order to protect the legitimate rights and interests of users, please carefully read the instructions, disclaimers and safety instructions provided with this product before using this product.
2. This product is not suitable for people under the age of 14. People under the age of 14 need to use it under the supervision and guidance of adults with aircraft flight experience.
3. Once you start using the product, you are deemed to have read, understood, recognized and accepted all terms and contents of the product's instructions, disclaimers and safety instructions.
4. In the process of using this product, please be sure to strictly abide by and implement the requirements including but not limited to the instructions and safety instructions. For all personal injuries, accidents, property losses, legal disputes and all other adverse time resulting in conflict of interest caused by using behaviors or irresistible factors in violation of safety instructions, the user shall bear relevant responsibilities and losses, and the company will not bear any responsibilities.
5. The company will not be liable for any direct or indirect violation of laws and regulations caused by the user's use of the product.

SAFETY INSTRUCTIONS

1. This product is not suitable for people under the age of 14 and other people without full civil capacity.
2. The product has high-speed rotating blades and powerful flight power, and has certain danger in operation. Do not approach or touch the product while it is working.
3. When using this product, please keep away from dangerous environment such as airport, railway, highway, high building, electric wire, etc.
4. When using this product, please keep away from the high electromagnetic interference environment such as mobile base station, high-power transmitting equipment, etc.
5. When using this product, please keep away from all kinds of manned aircraft.
6. Please do not use this product in rain, thunder, dust, fog, snow, strong wind, low temperature and other harsh environment
7. This product is non waterproof design, please do not operate this product near the water area.
8. When operating this product, please always keep a safe distance of about 10 meters between the aircraft and people or animals.
9. Always keep the aircraft flying within the operator's visual range.
10. Do not hover or fly over the crowd, please don't take pleasure in frightening others
11. Do not operate this product near the place where children play.
12. Do not use this product to chase vehicles or affect the normal operation of vehicles.
13. Do not turn off the aircraft when the product is flying in the air without emergency.
14. This product can not be used under the circumstances of drinking, fatigue, taking drugs, physical discomfort, etc.
15. Please check the product before each use, including but not limited to the firmness of parts, cracks and wear of engine body and propeller. Battery capacity, validity of indicator, etc. In case of any abnormality, please stop using and replace the corresponding accessories immediately.
16. The aircraft in abnormal working condition may have accidents. Do not start the blade or barely fly.
17. Do not attempt to block any moving parts in the operation of this product.
18. Do not modify this product or use it for non original design purposes.
19. Do not operate this product in the no fly zone of laws and regulations.

20. Due to the variety of materials used in the aircraft, high temperature will damage the internal structure of the aircraft, and lead to unpredictable consequences. Therefore, please keep the aircraft away from the heat source and avoid exposing to direct sunlight for a long time.
21. Please follow the product instruction manual.
22. Please use original accessories for maintenance and replacement.
23. Please make sure that other operator understands and abides by the safety instructions.
24. Do not mix different types of batteries.
25. Do not use expanded, leaking or damaged batteries.
26. Keep away from inflammables when charging the battery (such as blankets, solid wood furniture, wooden boards, etc.)
27. Please use the original charging line. Do not use other brands or damaged charging lines.
28. Please keep a safe distance from the high-speed rotating blades to avoid the risk of strangulation and cutting.
29. Do not use the aircraft close to the ear! Misuse may cause hearing loss.
30. Aircraft should be used as far away from other electrical equipment and magnetic objects as possible, which may cause mutual interference.
31. Please do not short circuit or squeeze the battery to avoid explosion.
32. The motor is a hot part. Please do not touch it to avoid scalding.

CHARGING PRECAUTIONS

1. There are certain risks in using lithium battery, which may cause significant losses to people and property. Please use it carefully and bear all relevant responsibilities by yourself.
2. If the battery leaks, avoid contact with skin and eyes. If you touch the skin, please wash it immediately with soap and clear water. In case of contact with eyes, wash immediately with plenty of water and see the doctor immediately.
3. If the charger emits odor, noise or smoke, please unplug the power supply immediately.

CHARGING INSTRUCTIONS

1. Please use the original special charger for charging. Do not use damaged or other brand chargers.
2. Do not charge batteries that are swollen, leaking or damaged.
3. Do not overcharge the battery. Once the battery is fully charged, please dial out the charger.
4. Do not charge on the surface near inflammables (blankets, wood floor, solid wood furniture, etc.) or conductive objects. Please keep the battery in the view range when charging.
5. Do not charge the battery immediately after using the product and wait for the battery to cool down for 10-15 minutes.
6. The charging temperature of the battery should be between 0 °C and 40 °C.

RECOVERY

The device consists of electronic components and batteries. For electronic waste, please carry out special treatment according to the local waste treatment requirements.

PRODUCT INTRODUCTION

AIRCRAFT INTRODUCTION

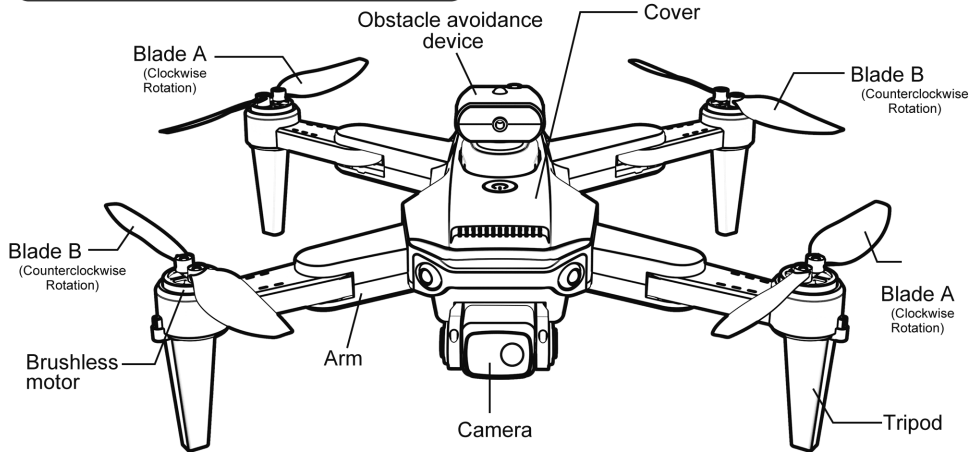

NOTE

Note: Photos are for reference only, please in kind prevail.

When replacing the blades, ensure that the blades a / b installed on each shaft are consistent.

REMOTE CONTROL INTRODUCTION

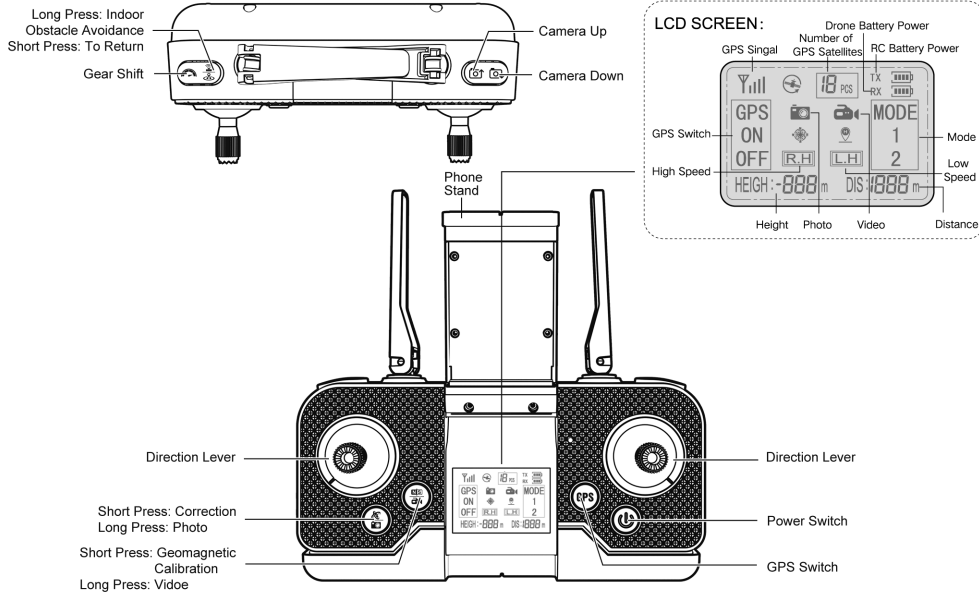

RC low power prompt: When the power supply of the remote control is lower than 3.5V, it will deliver a low power prompt sounds of Di, Di. It prompts the user to charge the charger.

CHARGING AND BATTERY INSTALLATION

CHARGING

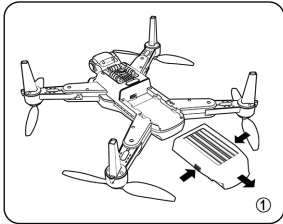

1. Pressing and holding two sides of the battery and pushing it down to remove the batteries from the aircraft. (Figure 1)

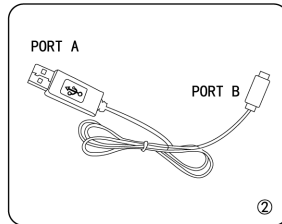

2. Connect the original charging line for charging. (as shown in Figure 2)

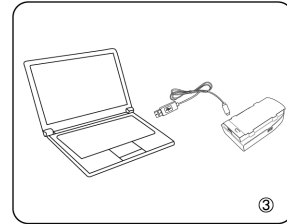

3. Plug in the power adapter (Figure 3)

As shown in the figure above, after disconnection, connect the interface A to the USB of the computer, while connect the interface B to the lithium battery, the red light will be on for a long time. And the red light will go out when fully charged with the charging time about 180 minutes.

Note: Please use the factory charger for charging. It is forbidden to use the damaged or other brand chargers for charging.

REMOTE CONTROL INSTALLATION BATTERY

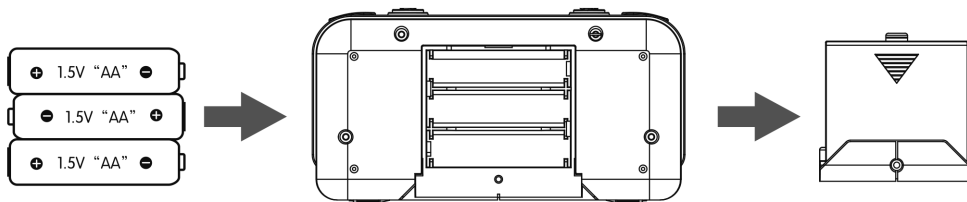

(Remote control installation battery)

Open the battery cover and insert 3 AA batteries correctly according to the electrode instructions.

- When installing the battery, the positive and negative poles of the remote control and the battery must be identified, and the battery must not be installed reversely.
- Do not mix old and new batteries or different types of batteries.

MOBILE PHONE INSTALLATION

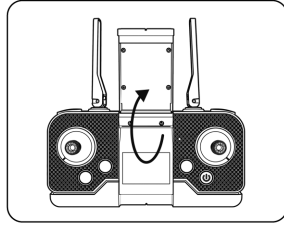

1. Open the mobile phone bracket on the remote control.

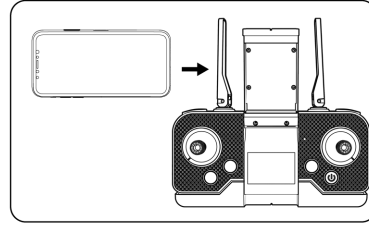

2. Install the mobile phone on the mobile phone bracket.

FUNCTION INSTALLATION

LEVER INTRODUCTION

1. Left (Throttle) Lever (The left lever controls the flight height and left and right directions)

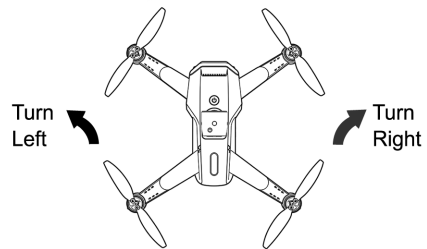
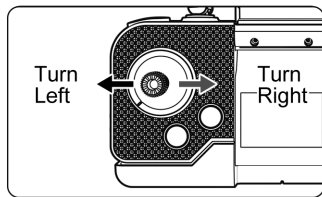
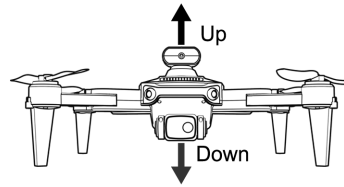
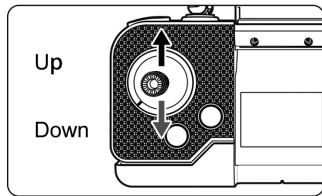

1. Right (Direction) Lever (The right joystick controls the forward, backward, and Left/right-side flight directions)

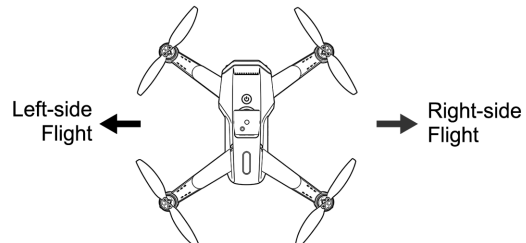
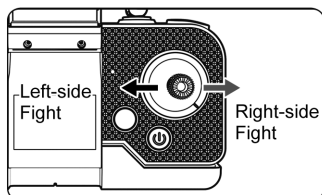
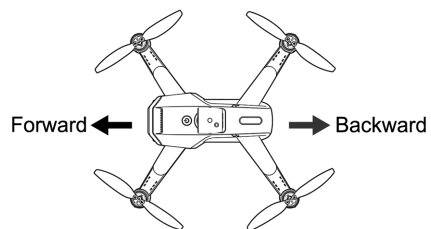
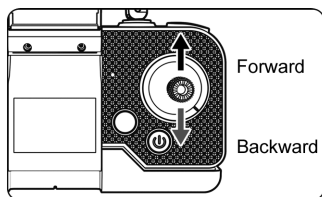

INTRODUCTION TO GPS FIXED POINT

1. After the frequency matching of the aircraft is successful, it will take 1-3 minutes in the open and unobstructed environment, the remote control delivery sounds of Di Di, and the front and rear lights of the aircraft will be on for a long time, it means the fixed point is successful.
2. When the front and rear lights of the aircraft flicker, it indicates that the current position is disturbed by signals, thus it is suggested to change the play site of the open areas such as in the roof, square, river side and seaside, etc.
3. Long press the "GPS Switch" button to turn off the GPS function. And when the screen displays "OFF", that is entering the indoor mode.

ONE KEY RETURN

- ① One key return: When you press One key return, the RC will continue to deliver alarm sound of Di, Di, and the aircraft will start to return to the take-off position for landing. After the end of One key return, the sounds of Di will automatically cancel after 3 seconds from the remote control.
- ② Automatic return: when the aircraft detects the first level low voltage, the front and rear lights of the aircraft will flash slowly, and the aircraft will automatically return to a height of about 20 meters within the radius of the take-off point and the altitude will automatically land on the ground; at this time, the aircraft can fly for about 2-4 minutes. When the secondary low voltage is detected and the aircraft is less than 10 meters high, it will automatically rise 10-20 meters high, return to the take-off point and automatically land on the ground and stop flying.

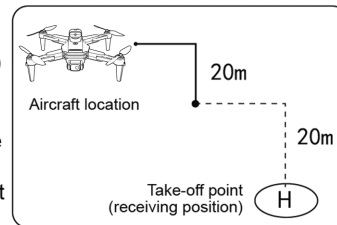

PHOTO AND VIDEO

1. Short press the photo button on the remote control, or click the photo icon on the app interface to take photos.
2. Long press the video button on the remote control, or click the video icon on the app interface to record. Press the key again or click the icon to stop recording, and the video will be saved on the app and mobile phone.

NOTE

1. When the aircraft is connected to the mobile phone and the aircraft is not insert with a SD card, the photos and videos will be saved to the mobile phone.
2. There are 3 gears for speed.

SPEED

Move the high and low speed switch buttons on the remote control to control the flight speed.

(One sound of "Di" is slow speed, and two sounds of "Di" "Di" are high speed.
Power on is slow speed by default)

Speed switch

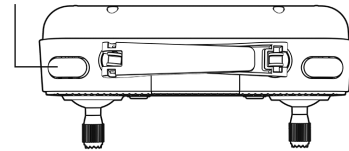

LIGHT

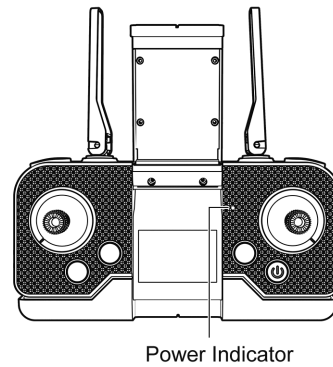
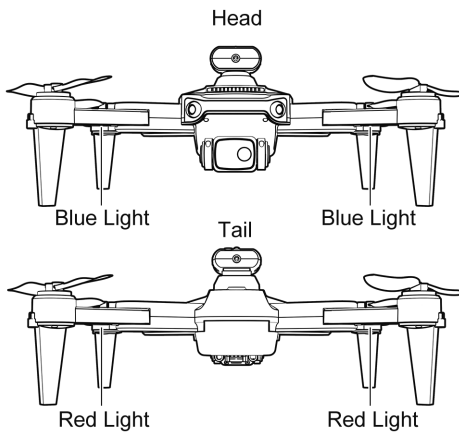

SAFE FLIGHT GUIDE

It is recommended to fly under the following conditions:

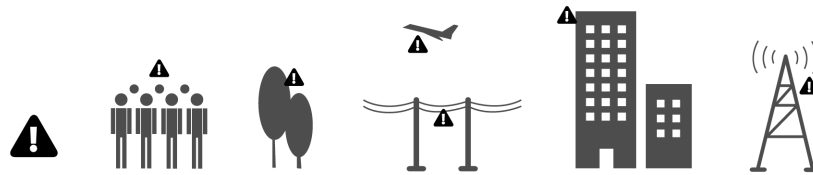

It is recommended to avoid flying over or near people, trees, high-voltage power lines, buildings, airports or water, as well as high-intensity power or base stations, because it may affect the compass on the aircraft.



Do not use this product under severe weather conditions, such as rain, snow, fog and wind speed exceeding 10m / s or 22mph.

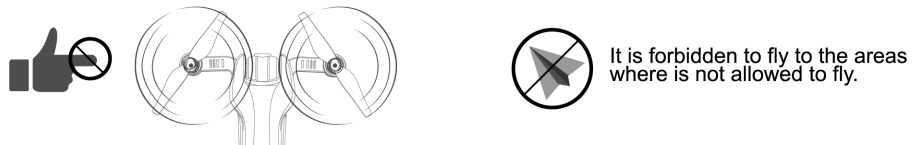

Keep away from rotating blades and motors.

It is very important to understand safety guidelines for safe flight. Please read them carefully before flight.

PREPARATION BEFORE TAKE-OFF

FREQUENCY

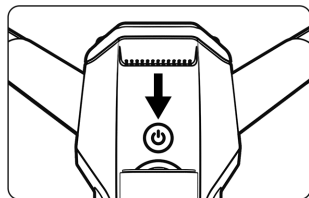

Install the battery in the aircraft, then press and hold the aircraft Power switch for more than 3 seconds, the aircraft will beep. The lights on the front and rear tripods of the aircraft flash slowly.

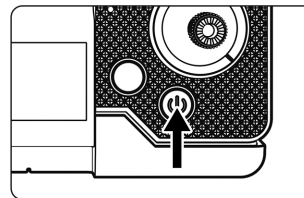

Turn on the power switch of the remote control and hear "di". With a beep, the remote control indicator light is on, flying. The front tripod light of the device is on continuously, and the rear tripod light flashes slowly. At this time, the was successfully matched.

CORRECTION GEOMAGNETIC

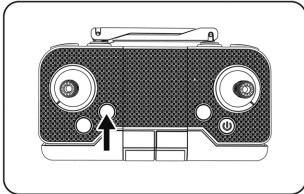

Short press one key to correct the geomagnetic field with the remote control deliver out a sound of Di and the four tripod lights in front and back of the aircraft flash regularly.

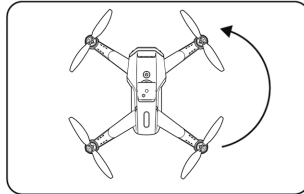

Pick up the aircraft horizontally and turn it three times with the remote control deliver out a sound of Di and the green light of the aircraft is long term on.

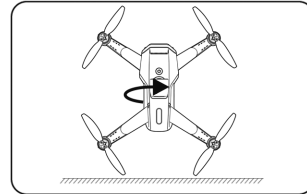

Pick up the aircraft vertically and turn for three times with the remote control deliver out two sounds of Di. And the four lights of the aircraft flash slowly, after the four lights of the aircraft are on, it indicating that the geomagnetic correction is successful.

CORRECTION GYRO

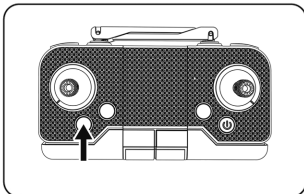

Short press the correction gyro button, and hear "DI" sound. The front and rear lights change from fast flashing to the front light stays on, The back light flashes slowly. The gyroscope is calibrated successfully.

TAKE-OFF

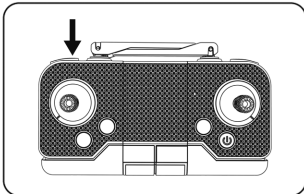

After completing the above operations, the aircraft will automatically search for GPS signals. When the inner grille is unlocked, the aircraft motor starts to rotate, and the unlocking is successful at this time.

(When the front and rear lights of the aircraft flicker, it indicating that the current position is disturbed by signals, thus it is suggested to change the play site of the open areas such as in the roof, square, river side and seaside, etc.)

TAKE OFF INDOOR

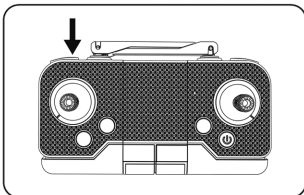

After completing the above operations, long press the "GPS Switch" button on the remote control to turn off the GPS function. When the screen shows OFF means that the aircraft entering the indoor mode. Long press the button of gyroscope calibrate from the remote control and then pull inside to unlock. The aircraft motor starts to rotate, and the unlock succeeds.

ONE KEY TAKE-OFF/LANDING

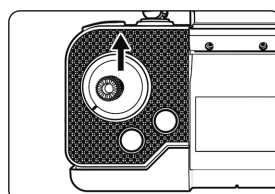
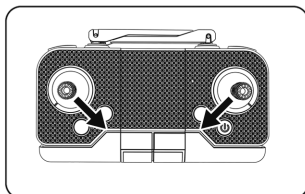

1. One Key Take-off/Long press emergency stop

After unlocking (as shown in the figure), short press the take-off / landing button, or click the take-off icon on the app interface to control the aircraft to take-off.

2. One Key Landing/Long press emergency stop

When the aircraft needs to land in flight, press the take-off / landing button again, the aircraft will automatically land on the ground and stop flying. During the descent, the course can be controlled by the lever. During the descent, press the take-off / landing button, and the descent will stop.

PROBLEM SOLVING GUIDE

problems	causes	solutions
Power off of the remote controller	1 The switch is on the position of "OFF"	1 Move to the position of "ON"
	2 Power off	2 Checking and change the new batteries
Remote controller has no response	1 No turning on the energy	1 Move to the position of "ON"
	2 No connecting the aircraft' s batteries	2 Checking and correct connect the power on
	3 Strong wind	3 Please play indoors where is spacious.
Aircraft can not be up	1 Rotor speed is too low	1 Push up the accelerator
	2 The aircraft' s power is not enough	2 Please make the aircraft' s batteries fully charged
Out of control	Accelerator operated no return the aircraft upward	when you do the frequency modulation, the accelerator operated should be back to the original position
	Out of the control distance	Please play within the effective distance
Excessive landing	The speed of accelerator pulling is too fast.	Please pull the control lever slowly, maintain a smooth landing.

ACCESSORY DRAWING

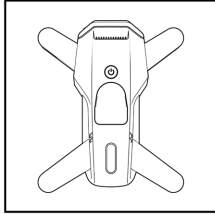

01.upper body

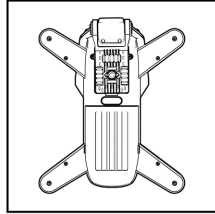

02.lower body

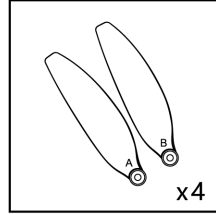

03.protecting frame

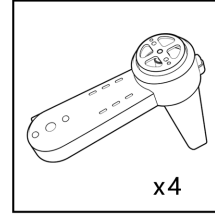

04.axis

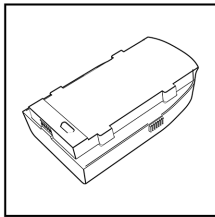

05.battery

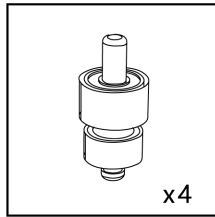

06. motor

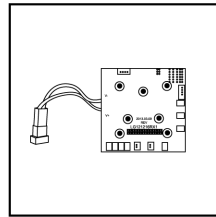

07. receiver board

Note: photos are for reference only, please in kind prevail.

