

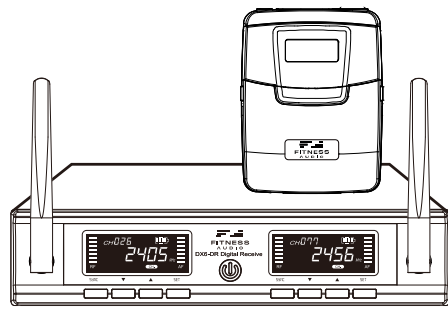

Operation manual

DX6-DR / DX6-TF Dual Channel Frequency Hopping Digital Wireless Microphone System



Important safety instructions

- READ, KEEP and HEED these instructions.
- CLEAN ONLY with dry cloth.
- DO NOT block any ventilation openings. Allow sufficient distances for adequate ventilation and install in accordance with the manufacturer's instructions.
- DO NOT install or place near any heat sources such as open flames, radiators, heat registers, stoves, or other apparatus (including amplifiers) that produce heat.
- DO NOT defeat the safety purpose of the polarized or grounding type plug. A polarized plug has two blades with one wider than the other. A grounding type plug has two blades and a third grounding prong. The wider blade or the third prong are provided for your safety. If the provided plug does not fit into your outlet, consult an electrician for replacement of the obsolete outlet.
- PROTECT the power cord from being walked on or pinched, particularly at plugs, convenience receptacles, and the point where they exit from the apparatus.
- ONLY USE attachments/accessories specified by the manufacturer.
- USE only with a cart, stand, tripod, bracket, or table specified by the manufacturer, or sold with the apparatus. When a cart is used, use caution when moving the cart/apparatus combination to avoid injury from tip-over.
- UNPLUG this apparatus during lightning storms or when unused for long periods of time.
- REFER all servicing to qualified service personnel. Servicing is required when the apparatus has been damaged in any way, such as power supply cord or plug is damaged, liquid has been spilled or objects have fallen into the apparatus, the apparatus has been exposed to rain or moisture, or does not operate normally.
- To reduce the risk of fire or electric shock, do not expose this apparatus to rain or moisture.
- Do not attempt to modify this product. Doing so could result in personal injury and/or product failure.

Federal Communication Commission Interference Statement

This equipment has been tested and found to comply with the limits for a Class B digital device, pursuant to Part 15 of the FCC Rules. These limits are designed to provide reasonable protection against harmful interference in a residential installation.

This equipment generates, uses and can radiate radio frequency energy and, if not installed and used in accordance with the instructions, may cause harmful interference to radio communications. However, there is no guarantee that interference will not occur in a particular installation. If this equipment does cause harmful interference to radio or television reception, which can be determined by turning the equipment off and on, the user is encouraged to try to correct the interference by one of the following measures:

- Reorient or relocate the receiving antenna.
- Increase the separation between the equipment and receiver.
- Connect the equipment into an outlet on a circuit different from that to which the receiver is connected.
- Consult the dealer or an experienced radio/TV technician for help.

FCC Caution: To assure continued compliance, any changes or modifications not expressly approved by the party responsible for compliance could void the user's authority to operate this equipment. (Example - use only shielded interface cables when connecting to computer or peripheral devices).

FCC Radiation Exposure Statement

This equipment complies with FCC RF radiation exposure limits set forth for an uncontrolled environment. This equipment should be installed and operated with a minimum distance of 0.5 centimeters between the radiator and your body.

This transmitter must not be co-located or operating in conjunction with any other antenna or transmitter.

The antennas used for this transmitter must be installed to provide a separation distance of at least 0.5 cm from all persons and must not be co-located or operating in conjunction with any other antenna or transmitter.

This device complies with Part 15 of the FCC Rules. Operation is subject to the following two conditions:

- (1) This device may not cause harmful interference, and
- (2) This device must accept any interference received, including interference that may cause undesired operation



■ Frequency: 2402~2480MHz, Maximal power: 20 mW (DX6-TF)
■ CE declaration info: www.chiayo.com.tw/declaration.html

Thank you for choosing FITNESS AUDIO digital wireless microphone system!
 For more details, please take a few moments to read this operating manual for thorough understanding of the function and operation of both transmitter and receiver.

In the box

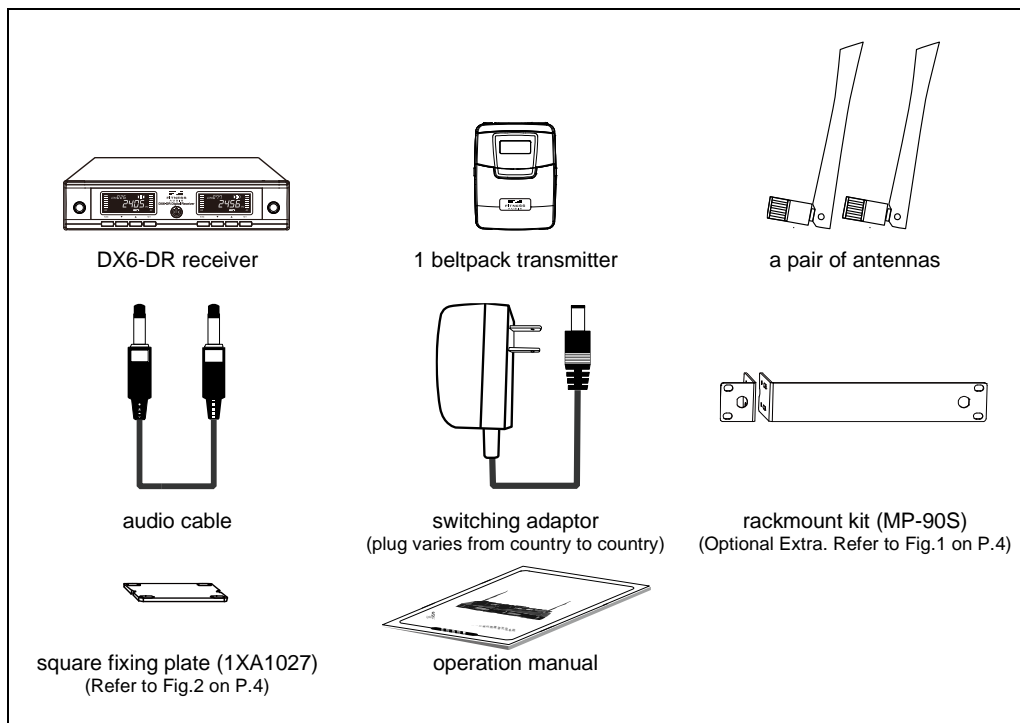

**The above specifications are subject to change without prior notice.

Important usage instructions

- To cope with the complicated 2.4GHz wireless environment, the line-of-sight distance between the microphone and the receiver should be shortened to ensure that the signal is not blocked.
- When one receiver is used with two microphones, it is recommended that the microphones be set to A-SCAN mode. (Please refer to P5)
- When two receivers are used with four microphones, the microphones should be set in F-CH01~F-CH04 modes respectively and the modes cannot be repeated. (Please refer to P5)
- The A-SCAN mode and F-CH01~F-CH04 mode cannot be mixed in the same system.
- When the system encounters interference or signal interruption, try the following:
 - The microphone enters the A-SCAN function page and scans to search for the best available channel.
 - The receiver should be kept at least 5 meters away from other WiFi, Bluetooth or 2.4GHz devices in use.
 - Keep the distance between the microphone and the receiver at least 2 meters.

Parts and functions of DX6-DR receiver

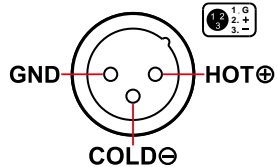
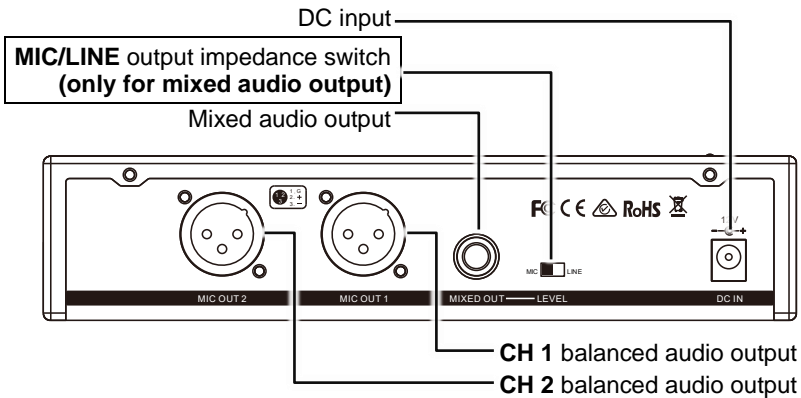
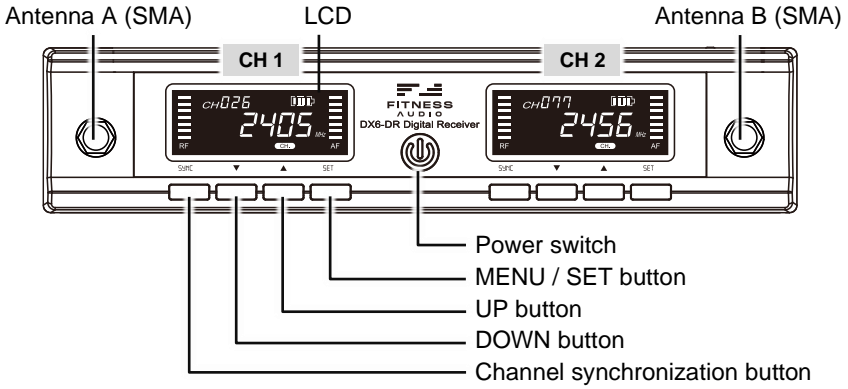

Antenna installation

Install supplied 2.4GHz receiver SMA antenna A and B at SMA connectors on the front panel. Please make sure the antennas being firmly tightened otherwise the reception quality might be affected.

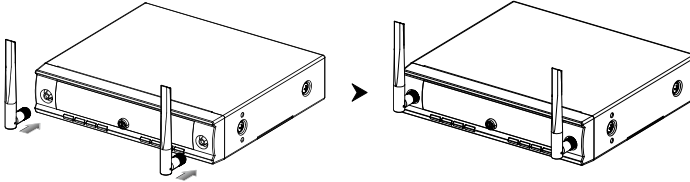

Receiver placement

1. The receiver should be at least 1m above the ground and 1m away from a wall or metal surface to minimize reflections.
2. The transmitter should also be at least 1m away from a wall or metal surface to minimize reflections.
3. The transmitter should also be at least 1m away from the receiver. Keep antennas away from noise source such as motors, automobiles, neon light as well as large metal objects.
4. The receiver should be at least 5m away from 2.4GHz wifi or other 2.4GHz transmitting devices.
5. Power voltage should not below 12V DC or above 15V DC. Deficient current causes unstable operating voltage or malfunction and over current shortens the product life and possibly damages circuits.

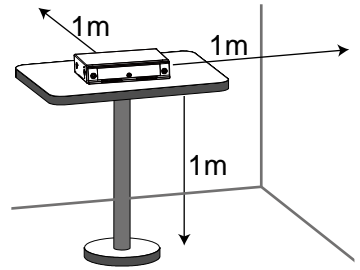

Rack mounting

The receiver can be cabinet-mounted by either one or two units. If only one receiver is to be mounted, an optional kit is available and it's installed as shown in Fig 1. If two receivers are to be mounted, they can be assembled by another kit and installed as shown in Fig 2.

■ Rack mounting one receiver

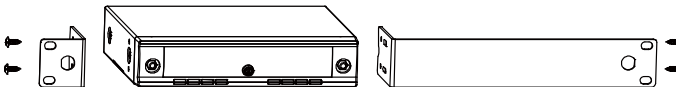

Fig 1

■ Rack mounting two receivers

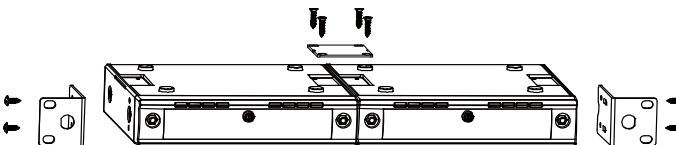

Fig 2

SCAN mode setting

There are five scan modes for selection: **A-SCAN**, **F-CH01**, **F-CH02**, **F-CH03** and **F-CH04**.

Mode	A-SCAN	F-CH01	F-CH02	F-CH03	F-CH04
Function	The microphone will automatically operate radio scanning to find and locate a group of clear, interference-free channels after entering A-SCAN page and holding SET button.	There are four modes for selection. Each mode includes several working channels which are different from those in any other mode.			
When to choose	<ul style="list-style-type: none"> ■ First-time operation. ■ Obvious environmental interference exists / happens. ■ Only one DX6-DR system (two transmitters) in the room. 	<ul style="list-style-type: none"> ■ Two DX6-DR systems (four transmitters) to operate simultaneously in the same room. ■ One system operates on F-CH01 and F-CH02 modes and the other system on F-CH03 and F-CH04. 			
Auto freq hopping	Yes	Yes			

1 Use **MENU** button to go to the SCAN mode page.

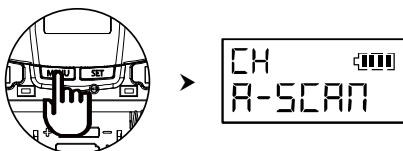

2 Press and hold **SET** button until the scan mode flashes to denote readiness for setting.

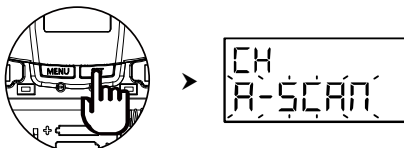

3 Press **SET** or **MENU** button to select a scan mode between **A-SCAN**, **F-CH01**, **F-CH02**, **F-CH03** and **F-CH04**. 6 seconds after selecting a scan mode, it will be automatically saved and the mode will not change after reboot until the setting is changed again.

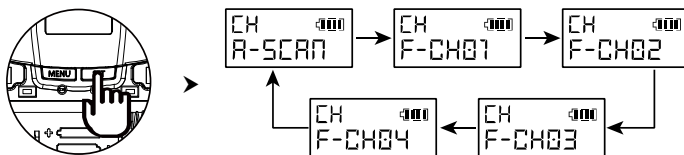

4 Without any button pressed, the transmitter will operate scanning and then change to **A-SCAN** mode.

Channel synchronization of the receiver and transmitter

- 1 Open the cover and hold the synchronization button until “SYNC” on the LCD flashes.

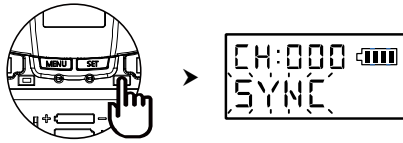

- 2 Hold the receiver's SYNC button until the LCD displays “-Sync-” and the channel number becomes the same as the transmitter indicative of successful channel synchronization.



Setting microphone's sensitivity from the receiver

- 1 Press SET button to make the sensitivity level flashes

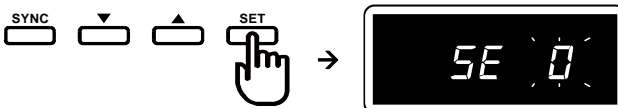

- 2 Press DOWN(▼) and UP(▲) button to adjust the sensitivity level between -1, 0 and 1.

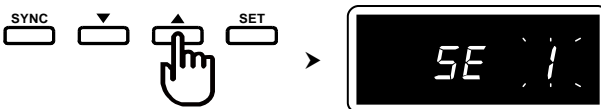

- 3 After a level is chosen, wait about 5 seconds to save the setting and the level will not change after reboot until the setting is changed again.

Setting the sensitivity of the **Aeromic**, **Cyclemic**, **EMic** or **Fitness Mic** headset microphones to the Fitness Audio **DX6-TF** beltpack transmitter:

Sensitivity value	-1	0	1
Dynamic range	high	middle	low
Noise & feedback	low	middle	high
Mic cartridge to mouth	< 3 cm	3 cm to 5 cm	> 5 cm

Important:

- The closer the distance to the mouth, the lower the sensitivity is required. The default gain level is **0**.
- Higher sensitivity will change the dynamic range of input signals which may result in feedback.
- Please set the sensitivity at the best level when setting up the microphone system.

Volume adjustment

- 1** Press **SET** button to make the volume icon  appear and flash.



- 2** Press **DOWN**(▼) and **UP**(▲) button to adjust the volume by 1dB / step, from -8dB (min) to +8dB (max). The default volume is 0dB.



- 3** After a level is chosen, wait about 5 seconds to save the setting and the level will not change after reboot until the setting is changed again.

Notch filter

When noise signals are picked up by the microphone, notch filter can prevent these signals entering the receiver. Its default status is ON.

- If using belt-pack transmitter, it's advised to turn on the notch filter.
- If using handheld transmitter, it's advised to turn off the notch filter.

1 Press **SET** button to make the text **NF** appear with ON / OFF flashing.

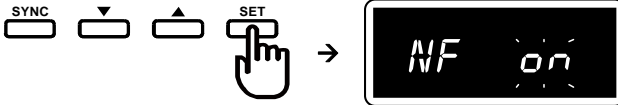

2 Press DOWN(▼) and UP(▲) button to turn ON / OFF the notch filter.

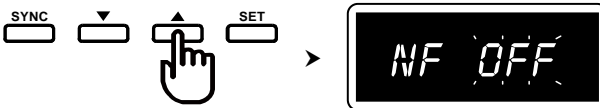



3 After a status is chosen, wait about 5 seconds to save the setting and the status will not change after reboot until the setting is changed again.

Equalizer setting

Equalizer adjustment is actually used to increase or reduce the high/mid/low frequency component of the speaker's restored sound. It is so-called raising or attenuating treble/bass via frequency-specific volume controls to improve human voices or make musical instruments' sound more prominent. According to the scale values on the screen, UP button is to increase and boost and DOWN button to decrease and attenuate.

Adjust the level of high frequency (Treble), mid frequency (Mid), and low frequency (Bass) respectively. All signals have been balanced by the high and low sounds after entering the receiver so it is not necessary to adjust the equalizer during the output to the speaker. It is recommended to maintain the value of BASS, MID and TREBLE at 0 dB.

DISPLAY	 BASS	 MID	 TREBLE
FUNCTION	increase or decrease the low frequencies	increase or decrease the mid frequencies	increase or decrease the high frequencies
RANGE	-8 dB ~ +8 dB		
DEFAULT	0 dB		

- 1 Press **SET** button to make the frequency icon (FREQ) appear with EQ value flashing. Then press **SET** to choose your target EQ band between 300 (BASS), 1000 (MID) and 3000 (TREBLE) (Hz).

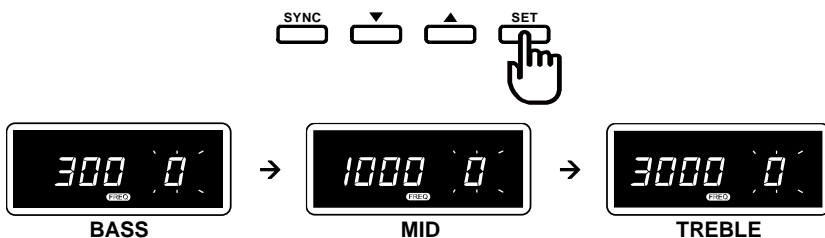

- 2 Press DOWN(▼) and UP(▲) button to adjust the EQ value by 2dB / step, from -8 (min) to 8 (max). The default BASS/MID/TREBLE level is 0 (dB).



- 3 After a level is chosen, wait about 5 seconds to save the setting and the level will not change after reboot until the setting is changed again.

Audio output connection

INDIVIDUAL balanced output

XLR connector provides balanced audio output signal from this jack to the mixer/amplifier. Use an audio output cable with “XLR” or “Cannon” connector, connect one end to the balanced output jack of the receiver, and the other end to the “**MIC IN**” jack of the mixer/ amplifier. (Fig 3)

MIXED unbalanced output

¼" PHONE PLUG connector provides unbalanced audio output signal from this jack to the mixer/amplifier. Use an audio output cable with ¼" PHONE PLUG connectors. Connect one end from the unbalanced output jack of the receiver, and the other end to the “**LINE IN**” or “**MIC IN**” jack of the mixer/ amplifier.

Level switch setting

- When connecting to the **LINE /AUX IN** of a mixer/amplifier, switch to “**LINE**” position (Fig 4). DO NOT use the “**MIC**” position as they may not deliver a sufficient high output level.
- When connecting to the “**MIC IN**” jack of a mixer/amplifier, switch to “**MIC**” position (Fig 5). Overload distortion may occur at the wrong level position.

INDIVIDUAL output to MIC IN

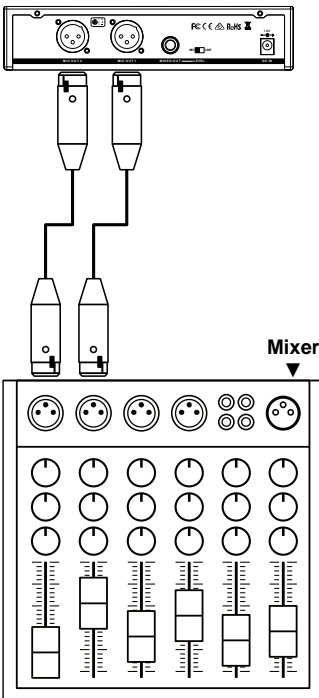

Fig 3

MIXED output to LINE/AUX IN

Slide LEVEL switch to LINE

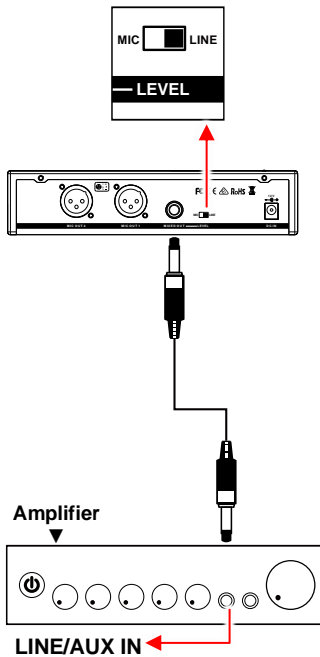

Fig 4

MIXED output to MIC IN

Slide LEVEL switch to MIC

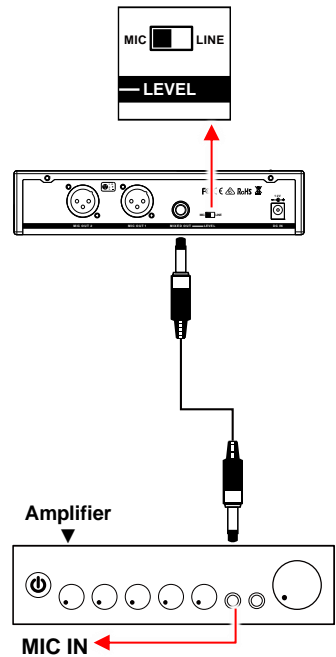
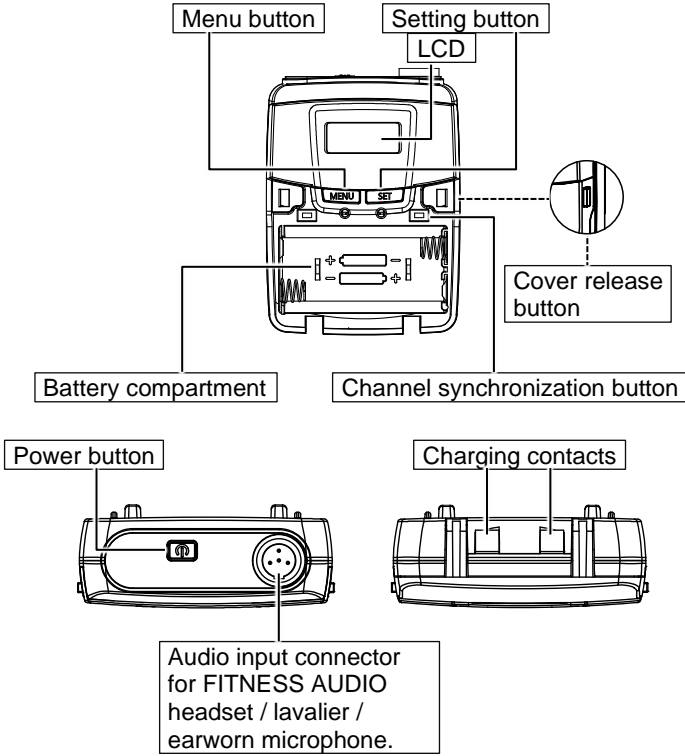

Fig 5

Parts and functions of DX6-TF transmitter



Battery installation & indicator

- 1 This transmitter requires two AA batteries to operate. To install, remove the battery cover and insert the batteries into the compartment.



- 2 Press the power button to turn on the transmitter. Press and hold the button for 2 seconds to turn off.

- 3 The battery status can be monitored by the transmitter's LCD

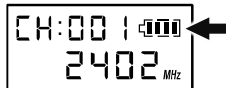

IMPORTANT: Batteries contain corrosive acid that may leak and damage the transmitter when stored for a long period. Batteries should be removed from the transmitter before storing without use for more than 4 weeks.

Audio mute setting

- 1** Press the power button to enable MUTE mode and the signal of microphone will not enter the transmitter. Press again to disable MUTE.

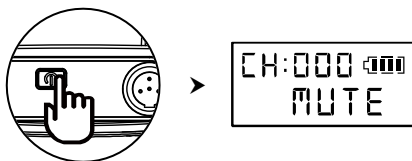

- 2** Under MUTE mode, the transmitter automatically turns off after 5 minutes.

Battery type setting

1 Use **MENU** button to go to the BATTERY TYPE page.

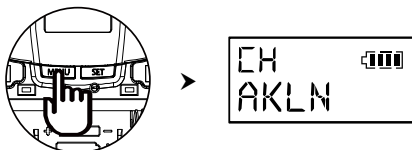

2 Press and hold **SET** button until **NIMH** or **AKLN** flashes to denote readiness for setting.

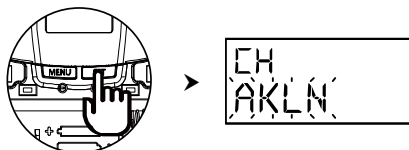

3 Press **SET** button to select either **NIMH** (rechargeable battery) or **AKLN** (alkaline battery).

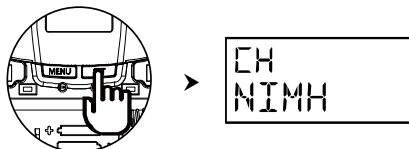

4 6 seconds after selecting a battery type, it will be automatically saved and the type will not change after reboot until the setting is changed again.

Important:

- To avoid dangers from overcharging, please turn off the transmitter before charging
- Do not charge primary batteries such as zink-carbon and alkaline batteries to avoid risks of leakage or dangers.
- Be sure to install the batteries by correct polarity to prevent device damages due to short circuit.
- Batteries of the same brand offer better quality consistency. Do not use batteries of different brands as possible.
- Do not mix new, old and different-brand batteries to prevent short circuit or malfunction.
- If the transmitter will not be used for a long period of time, the batteries should be removed and kept dry to avoid leakage and damage to the device due to battery self-discharge.
- If the battery leaks, cracks or deforms, stop using and take it out immediately.

FITNESS AUDIO PRODUCTS

ALSO INCLUDE:

Fitness Audio U-Series UHF Wireless System

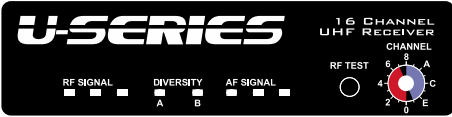

Fitness Audio Aerolink AL3.0 Bluetooth Receiver



Fitness Audio Aeromix AMX-32.2 Voice-over-Music Mixer

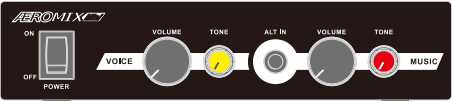

Fitness Audio Aeromix 2+2SR Voice-over-Music Mixer

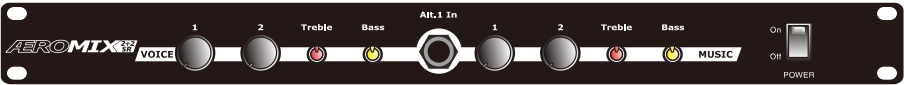

Fitness Audio LM-30 Loudness Monitor

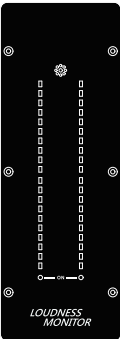

Fitness Audio SPL2 Sound Pressure Limiter



Fitness Audio products are distributed worldwide by Fitness Audio Network. They are manufactured to our specifications in Taiwan. Your DX-6 Wireless System is covered against manufacturing defects by a 12 month warranty commencing from your date of purchase.

Warranty Information

(Please retain for your records)

This product was purchased by:

(Your Business)

on (date).../... /... from (Company)

of (address)

Model Number(s)

Serial Number(s)

⚠ WARNING: This product can expose you to chemicals known to the State of California to cause cancer and birth defects or other reproductive harm. For more information go to www.P65Warnings.ca.gov.

Fitness Audio

Website: www.fitnessaudionetwork.com



Manufactured for Fitness Audio Network P/L
Unit 17 The Bourke Centre, 110 -116 Bourke Road, ALEXANDRIA, NSW 2015
AUSTRALIA

Made in Taiwan

