

# PHILIPS

## RESPIRONICS

### Amara View minimal contact full-face mask

## Instructions for Use

---

### Intended Use

This mask is intended to provide an interface for application of CPAP or bi-level therapy to patients. The mask is for single patient use in the home or multi-patient use in the hospital/institutional environment. The mask is to be used on patients (>66lbs/30kg) for whom CPAP and bi-level therapy has been prescribed.

---

**⚠Caution:** U.S. Federal law restricts this device to sale by or on the order of a physician.

---

### 🚫Note:

- An exhalation port is built into this mask so a separate exhalation port is not required.
  - This mask is not made with natural rubber latex or DEHP.
- 

### Symbols

 Warning or Caution

 Note

 Tip

 Consult Instructions for Use

 Not Made with Natural Rubber Latex

X1 System One Resistance Control

---

### ⚠Warnings

- This mask is not suitable for providing life support ventilation.
- This mask is designed for use with CPAP or bi-level systems recommended by your health care professional or respiratory therapist. Do not wear this mask unless the CPAP or bi-level system is turned on and operating properly. Do not block or try to seal the exhalation port. **Explanation of the Warning:** CPAP systems are intended to be used with special masks with connectors which have vent holes to allow continuous flow of air out of the mask. When the CPAP machine is turned on and functioning properly, new air from the CPAP machine flushes the exhaled air out through the attached mask exhalation port. However, when the CPAP machine is not operating, enough fresh air will not be provided through the mask, and exhaled air may be rebreathed. Rebreathing of exhaled air for longer than several minutes can in some circumstances lead to suffocation. This warning applies to most models of CPAP systems.

- If oxygen is used with the device, the oxygen flow must be turned off when the device is not operating. Explanation of the Warning: When the device is not in operation, and the oxygen flow is left on, oxygen delivered into the ventilator tubing may accumulate within the device enclosure. Oxygen accumulated in the device enclosure will create a risk of fire.
- At a fixed flow rate of supplemental oxygen flow, the inhaled oxygen concentration will vary, depending on the pressure settings, patient breathing pattern, mask selection, and the leak rate. This warning applies to most types of CPAP and bi-level machines.
- At low CPAP or EPAP pressures the flow through the exhalation port may be inadequate to clear all exhaled gas from the tubing. Some rebreathing may occur.
- Some users may experience skin redness, irritation, or discomfort. If this happens, discontinue use and contact your healthcare professional.
- Consult a physician if any of the following symptoms occur: Unusual chest discomfort, shortness of breath, stomach distension, belching, severe headache, blurred vision, drying of the eyes, eye pain or eye infections.
- This mask should not be used on patients who are uncooperative, obtunded, unresponsive, or unable to remove the mask.
- This mask is not recommended if the patient is taking a prescription drug that may cause vomiting.
- Consult a physician or dentist if you encounter tooth, gum, or jaw soreness. Use of a mask may aggravate an existing dental condition.
- A minimum of 3cm H<sub>2</sub>O (hPa) must be maintained when using this mask.
- Attaching an exhalation device requires therapy pressure level adjustment to compensate for increased leak.
- Do not overtighten the headgear straps. Watch for signs of overtightening, such as excessive redness, sores or bulging skin around the edges of the mask. Loosen the headgear straps to alleviate symptoms.
- Do not block or seal the anti-asphyxia valve or exhalation ports.

## Figure 1

- (A) Mask Cushion with Exhalation Ports  
(Do not block)
- (B) Mask Frame
- (C) Elbow with Anti-Asphyxia Valve  
(Do not block)
- (D) Quick Release Tabs
- (E) Quick Release Tube with swivel
- (F) Headgear Crown Strap
- (G) Headgear Top Side Strap
- (H) Headgear Bottom Side Strap
- (I) Headgear Clip

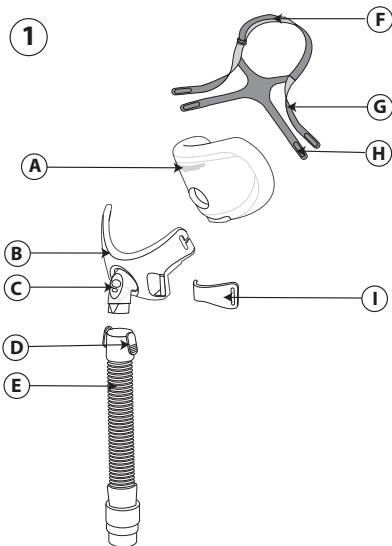

## Verify the Anti-Asphyxia Valve

The anti-asphyxia valve consists of an air inlet and a flapper (2). With the airflow turned off, verify that the elbow with the flapper is lying flat (a) so that room air can flow in and out through the air inlet. Next, with the airflow on, the flapper should now cover the air inlet and air from the CPAP or bi-level device should flow into the mask (b). If the flapper does not close or does not function properly, replace the mask.

**⚠Warning:** Do not block or seal the anti-asphyxia valve.

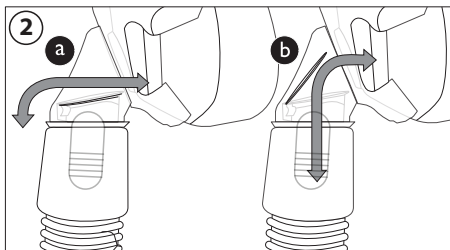

## Contraindications

This mask may not be suitable for use on patients with the following conditions: recent eye surgery or dry eyes, hiatal hernia, excessive reflux, impaired cough reflex, impaired cardiac sphincter function; or on patients unable to remove the mask by themselves.

---

## Before Use Read and Understand the Instructions Completely.

- Hand wash the mask.
  - Wash your face. Do not use moisturizer/lotion on your hands or face.
  - Inspect the mask and replace if the cushion has hardened or is torn, or if any parts are broken.
  - Verify that the therapy device, i.e., ventilator, including the alarms and safety systems, has been validated prior to use.
  - Verify therapy device pressure(s).
- 

## Cleaning Instructions

Hand wash the mask before first use and daily. The headgear should be hand washed weekly. The headgear does not need to be removed for daily cleaning of the mask.

1. Hand wash mask and headgear in warm water with liquid dishwashing detergent.
2. Rinse thoroughly. Air dry completely before use. Make sure the mask is dry before use. Lay the headgear flat or line dry. Do not place the headgear into the dryer.

**⚠Caution:** Do not use bleach, alcohol, cleaning solutions containing bleach or alcohol, or cleaning solutions containing conditioners or moisturizers.

**⚠Caution:** Any deviation from these instructions may impact the performance of the product.

**⚠Caution:** Inspect the mask for damage or wear (cracking, crazing, tears, etc). Discard and replace any components as necessary.

---

## Institutional Disinfection

Refer to the Disinfection Guide for Professional Users to reprocess between patients in a clinical setting. Access the latest version of the Disinfection Guide at [www.healthcare.philips.com](http://www.healthcare.philips.com) or by contacting customer service at 1-800-345-6443 (USA or Canada only) or +1-724-387-4000.

## Achieving the Right Fit

### Sizing the Mask

The mask should rest comfortably against your face. The cushion nostril opening goes under your nostrils (3). The headgear should be away from your eyes. The bottom of the mask cushion should rest just above your chin with your mouth slightly open.

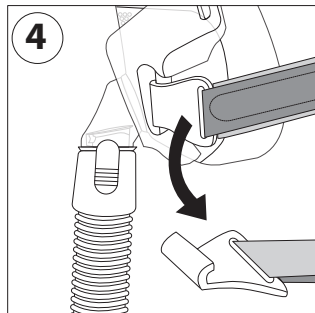
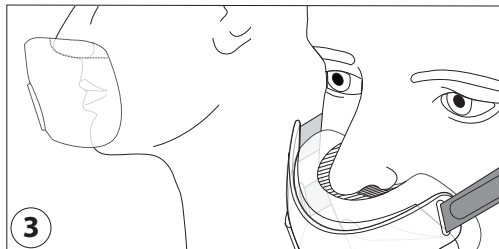

### Before putting on the mask:

1. Headgear - Loosen to a large setting.
2. Headgear clips - Grip and twist away from the frame to disconnect (4).

### Adjusting the mask:

1. Hold the mask against your face. Pull the headgear over your head (5).
2. Mask cushion - Place your nose over the cushion nostril opening. Push the mask cushion up.

**Note:** Do not place your nose in the cushion nostril opening.

3. Headgear clips - Press into place to connect.
4. Headgear - Pull back the tabs to adjust the top and bottom side straps. The headgear should fit loosely against your face. Do not overtighten.
5. Headgear - Pull the crown strap tab over to reduce leaks around your nose (6).
6. Headgear - Make final adjustments by pulling back the tabs to evenly adjust the top and bottom side straps. The headgear should feel snug, but not uncomfortably tight (7)(8).

**Note:** You should be able to fit one of your fingers underneath the top and bottom side straps.

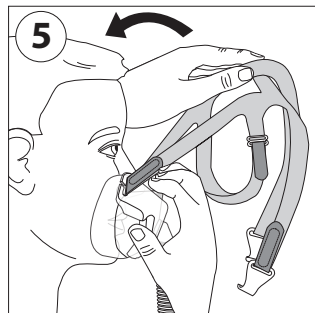

## Using the mask:

1. Connect the flexible tubing (included with your CPAP or bi-level device) to the quick release tube.
2. Lie down. Turn the therapy device on. Breathe normally. Keep your mouth slightly open.
3. Assume different sleeping positions. Move around until comfortable. If there are any excessive air leaks, make final adjustments. If there are any excessive air leaks around the nose, adjust the crown strap first. This will move the mask closer or further away from the bottom of your nose. Some air leaking is normal.

## \* Comfort Tips

- The most common mistake is overtightening the headgear. The headgear should fit loose and comfortable. If your skin bulges around the mask or if you see red marks on your face, loosen the headgear.
- Adjust the crown headgear strap to reduce leaks around your nose and to lift the straps off of your ears (6).
- Adjust the top and bottom side straps to reduce leaks at the sides or bottom of the mask cushion (7)(8).

## Removing the Mask

Disconnect the headgear clips and pull over the top of your head.

## Disassembly

1. Headgear clips - Grip and twist away from the frame to disconnect.
2. Headgear - Undo the straps. Pull out of headgear clips and mask frame slots.

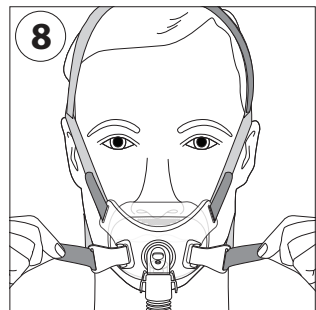
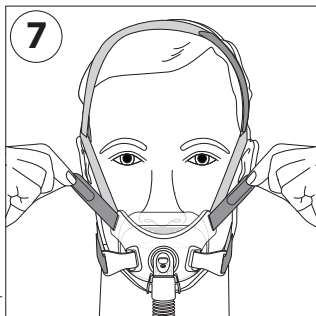
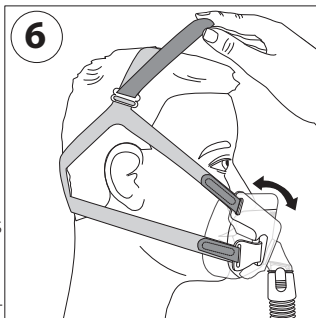

3. Mask Cushion - Grasp the top and the bottom of the mask cushion, and pull it off the mask frame ⑨.

ⓘ **Note:** Do not pull the mask cushion by the nostril cushion opening.

4. Quick Release Tube - Squeeze the quick release tabs. Pull the tube away from the mask frame ⑩.

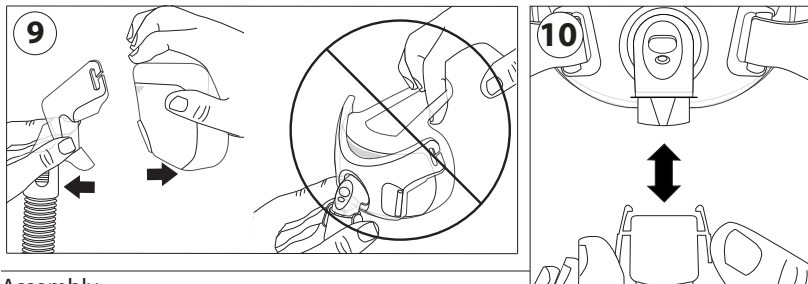

### Assembly

1. Headgear - Thread the headgear straps through the mask frame slots and headgear clips.

2. Headgear clips - Push the headgear clips onto the mask frame.

3. Mask Cushion - Grasp both sides and push it onto the mask frame.

4. Quick Release Tube - Push onto the elbow until the quick release tabs click into place.

### Philips Respironics System One Resistance Control

Your mask when combined with a Philips Respironics System One device, provides optimal resistance compensation. This mask value is X1 and should be set by your provider. Notes:

- Compare the mask to the device. See your device manual if the values do not match.
- System One is not compatible with masks that use a separate exhalation device.

## Specifications

**⚠ Warning:** The technical specifications of the mask are provided for your healthcare professional to determine if it is compatible with your CPAP or bi-level therapy device. If used outside these specifications, or if used with incompatible devices, the mask may be uncomfortable, the seal of the mask may not be effective, optimum therapy may not be achieved, disconnect alarms may not be detected, and leak, or variation in the rate of leak, may affect device function. The pressure flow curve shown below is an approximation of expected performance. Exact measurements may vary.

### Pressure Flow Curve

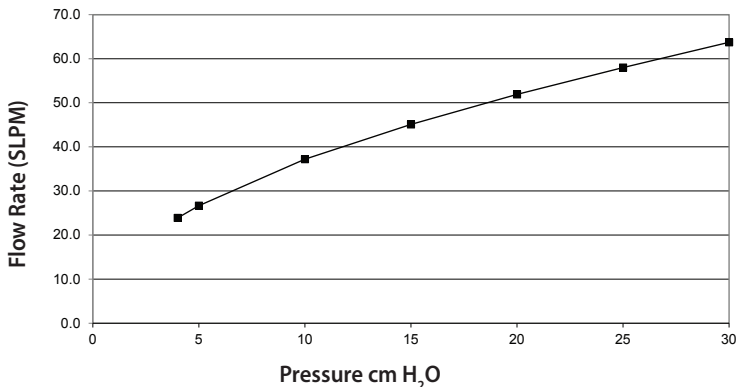

### Resistance with Anti-Asphyxia Valve Closed to Atmosphere

#### Drop in Pressure at

	50 SLPM	100 SLPM
All sizes	0.8 cm H <sub>2</sub> O	2.0 cm H <sub>2</sub> O

**Closed to Atmosphere:** A minimum of 3 cm H<sub>2</sub>O must be maintained to ensure that the anti-asphyxia valve closes.

**Open to Atmosphere:** In the absence of positive airway pressure, the anti-asphyxia valve will open.

### Inspiratory and Expiratory Resistance with Anti-Asphyxia Valve Open to Atmosphere at 50 SLPM

Inspiratory Resistance	1.0 cm H <sub>2</sub> O
Expiratory Resistance	1.5 cm H <sub>2</sub> O



## Deadspace

S	150.4 mL
M	148.8 mL
L	167.8 mL

---

## Sound Levels

A-weighted Sound Power Level	32.5 dBA
A-weighted Sound Pressure Level at 1m	24.2 dBA

---

## Disposal

Dispose of in accordance with local regulations.

---

## Storage Conditions

Temperature: -4° F to 140° F (-20° C to 60° C)

Relative Humidity: 15% to 95%, non-condensing

---

## LIMITED WARRANTY

Respironics, Inc. warrants that its mask systems (including mask frame and cushion) (the "Product") shall be free from defects of workmanship and materials for a period of ninety (90) days from the date of purchase (the "Warranty Period").

If the Product fails under normal conditions of use during the Warranty Period and the Product is returned to Respironics within the Warranty Period, Respironics will replace the Product. This warranty is non-transferable and only applies to the original owner of the Product. The foregoing replacement remedy will be the sole remedy for breach of the foregoing warranty. This warranty does not cover damage caused by accident, misuse, abuse, negligence, alteration, failure to use or maintain the Product under conditions of normal use and in accordance with the terms of the product literature, and other defects not related to materials or workmanship. This warranty does not apply to any Product that may have been repaired or altered by anyone other than Respironics.

Respironics disclaims all liability for economic loss, loss of profits, overhead, or indirect, consequential, special or incidental damages which may be claimed to arise from any sale or use of the Product. Some states do not allow the exclusion or limitation of incidental or consequential damages, so the above limitation or exclusion may not apply to you.

THIS WARRANTY IS GIVEN IN LIEU OF ALL OTHER EXPRESS WARRANTIES. IN ADDITION, ANY IMPLIED WARRANTY, INCLUDING ANY WARRANTY OF MERCHANTABILITY OR FITNESS FOR A PARTICULAR PURPOSE, IS SPECIFICALLY DISCLAIMED. SOME STATES DO NOT ALLOW DISCLAIMERS OF IMPLIED WARRANTIES, SO THE ABOVE LIMITATION MAY NOT APPLY TO YOU. THIS WARRANTY GIVES YOU SPECIFIC LEGAL RIGHTS, AND YOU MAY ALSO HAVE OTHER RIGHTS, WHICH VARY FROM STATE TO STATE.

To exercise your rights under this limited warranty, contact your local authorized Respironics, Inc. dealer or Respironics, Inc. at 1001 Murry Ridge Lane, Murrysville, Pennsylvania 15668, 1-800-345-6443 (USA and Canada only) or 1-724-387-4000.





Respironics Inc.  
1001 Murry Ridge Lane  
Murrysville, PA 15668 USA



1112274 R05  
AD 8/26/2016  
© 2016 Koninklijke Philips N.V. All rights reserved.