

Best doors PS 90 Sliding Fire Door Set Installation

WALL TYPE: **TIMBER STUD**

FRAME TYPE: **SLIDER**

CONSTRUCTION OF TIMBER FRAMED DRYWALL

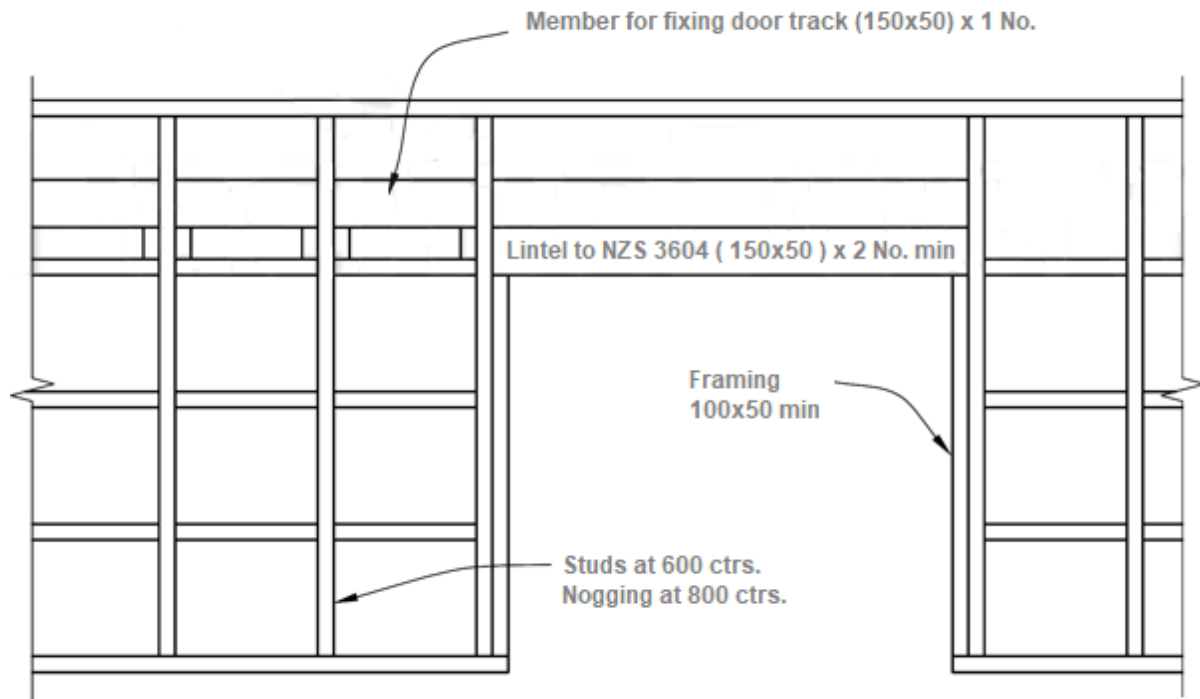

Elevation of typical framing at lintel

WALL TYPE: **MASONRY**

FRAME TYPE: **SLIDER**

MAGNETIC HOLD OPEN GENERAL SETUP

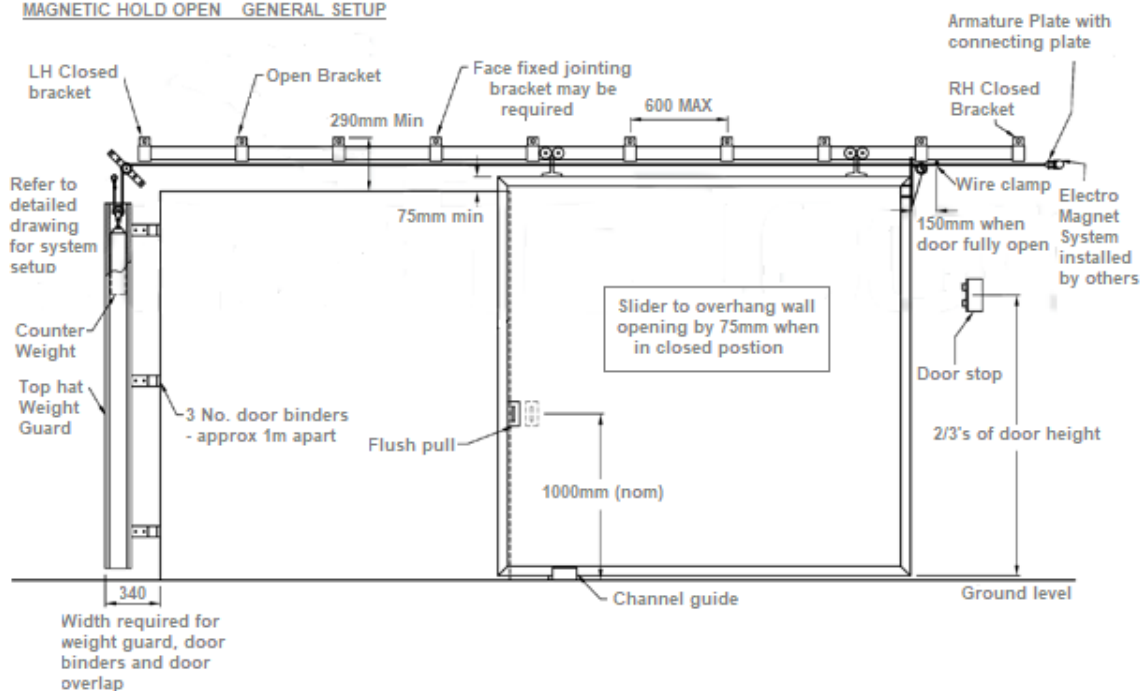

WALL TYPE: MASONRY

FRAME TYPE: SLIDER

MAGNETIC HOLD OPEN SYSTEM
-counterweight near to closed side

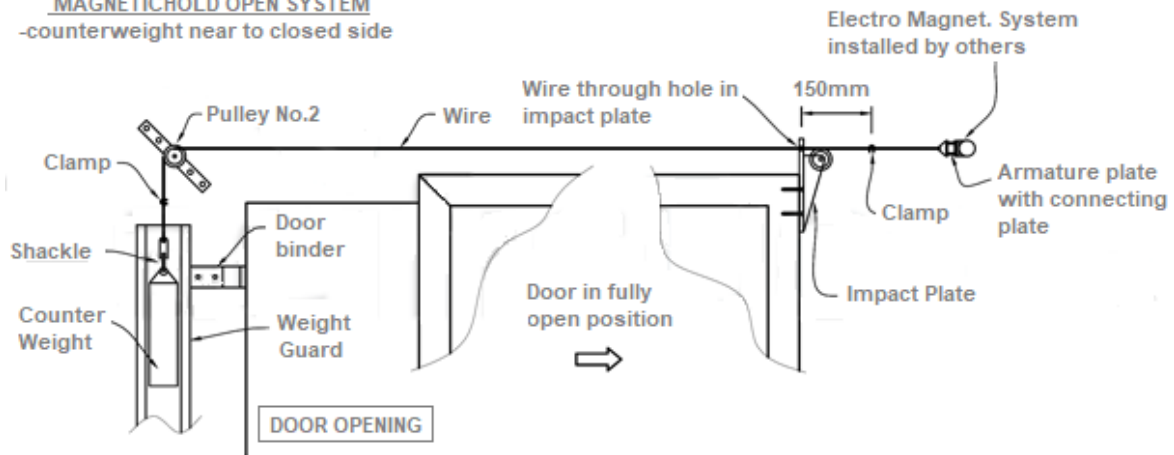

WALL TYPE: MASONRY

FRAME TYPE: SLIDER

MAGNETIC HOLD OPEN SYSTEM
-counterweight near to closed side

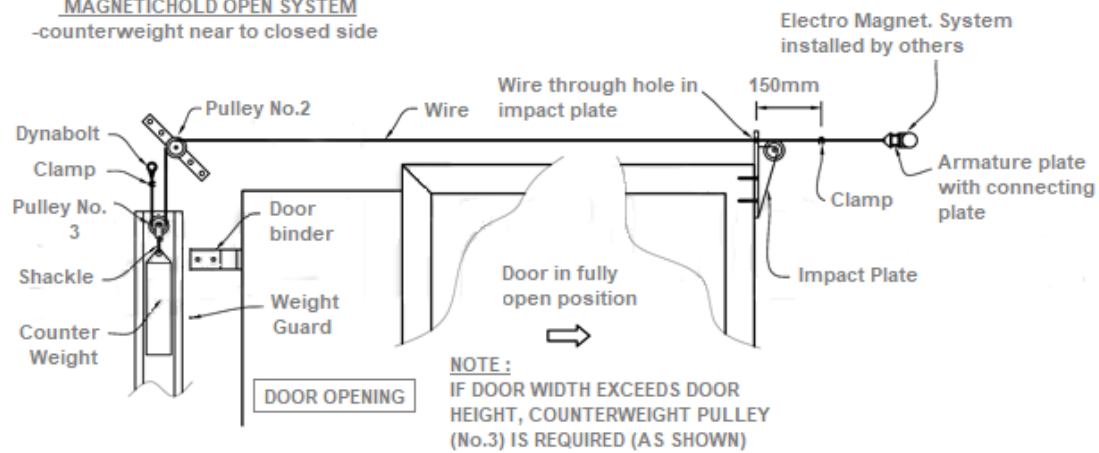

WALL TYPE: MASONRY

FRAME TYPE: SLIDER

MAGNETIC HOLD OPEN SYSTEM
-counterweight near to open side

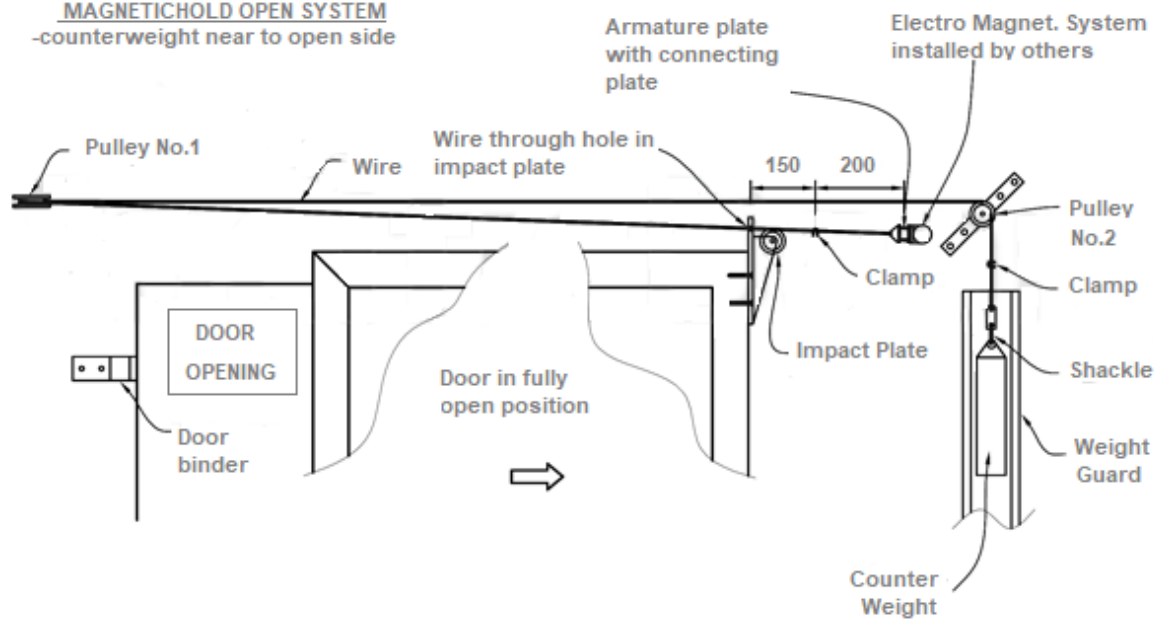

WALL TYPE: MASONRY

FRAME TYPE: SLIDER

MAGNETIC HOLD OPEN SYSTEM
-counterweight near to open side

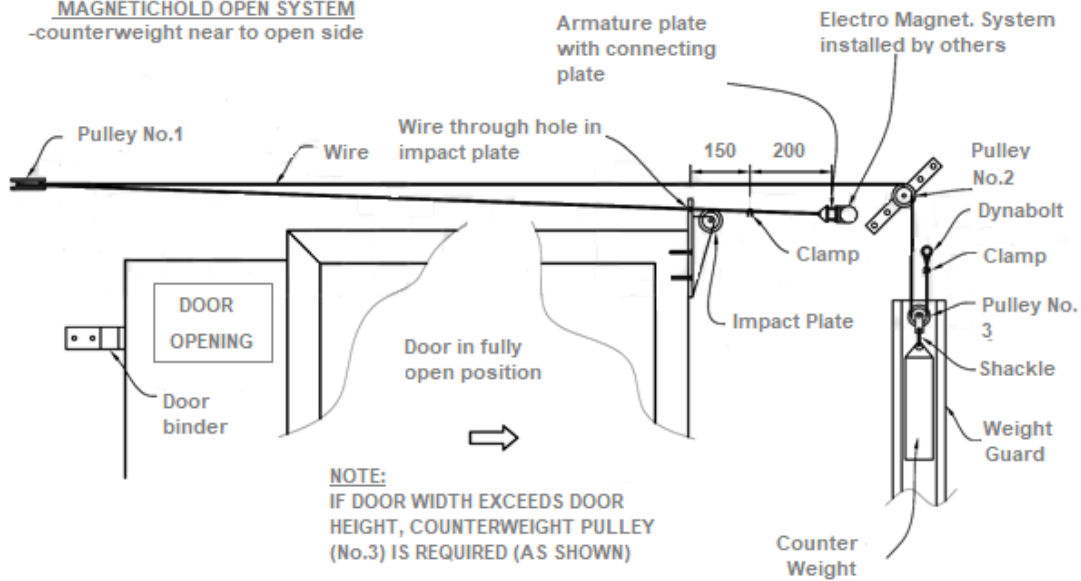

WALL TYPE: MASONRY

FRAME TYPE: SLIDER

FUSIBLE LINK GENERAL SETUP

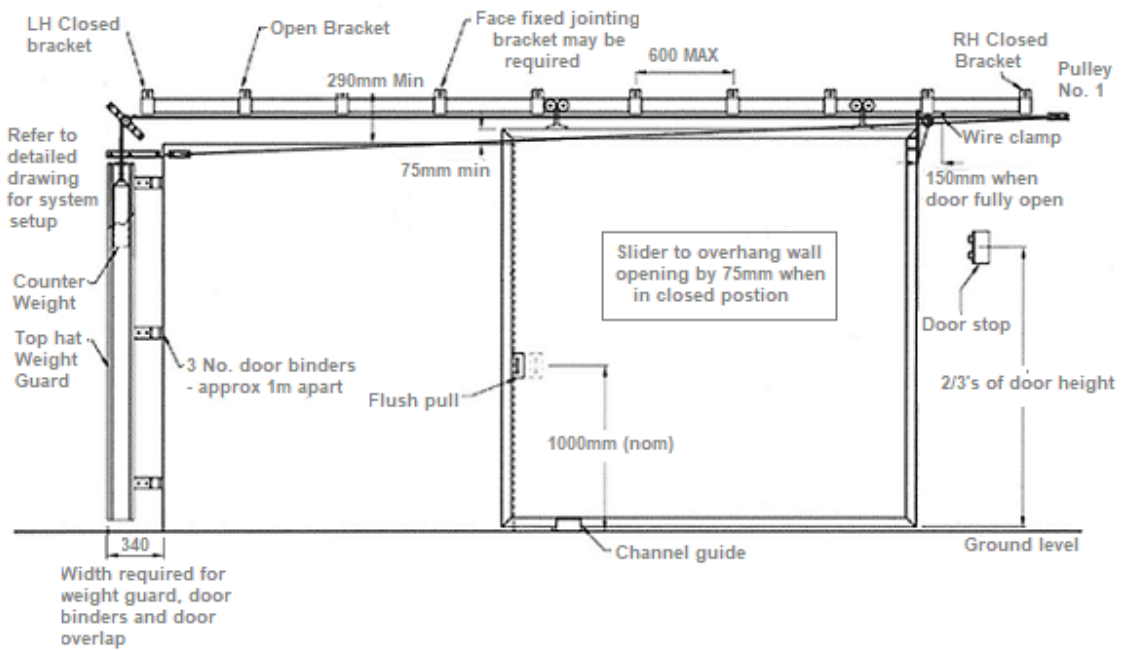

WALL TYPE: MASONRY

FRAME TYPE: SLIDER

FUSIBLE LINK SYSTEM

-counterweight near to closed side

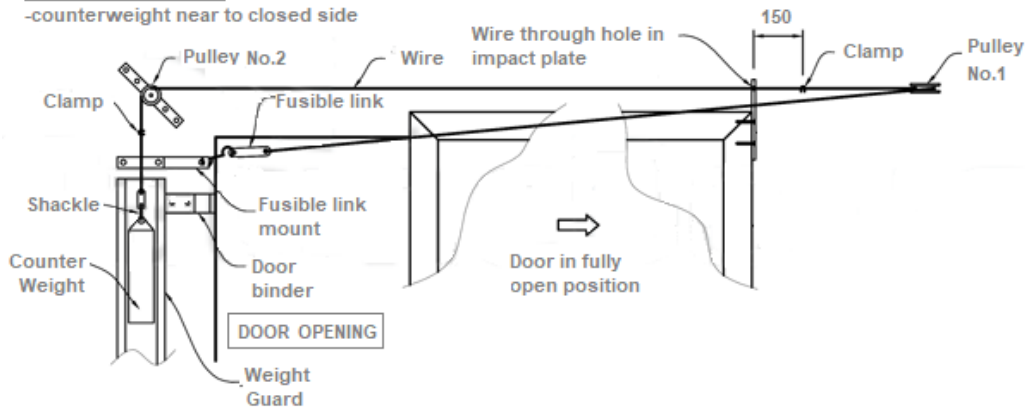

WALL TYPE: MASONRY

FRAME TYPE: SLIDER

FUSIBLE LINK SYSTEM

-counterweight near to closed side

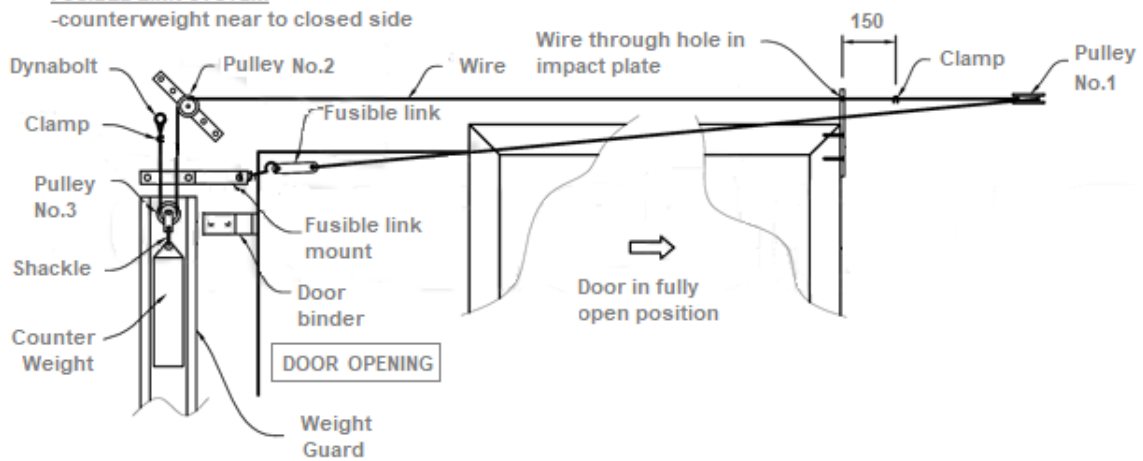

WALL TYPE: MASONRY

FRAME TYPE: SLIDER

FUSIBLE LINK SYSTEM

-counterweight near to open side

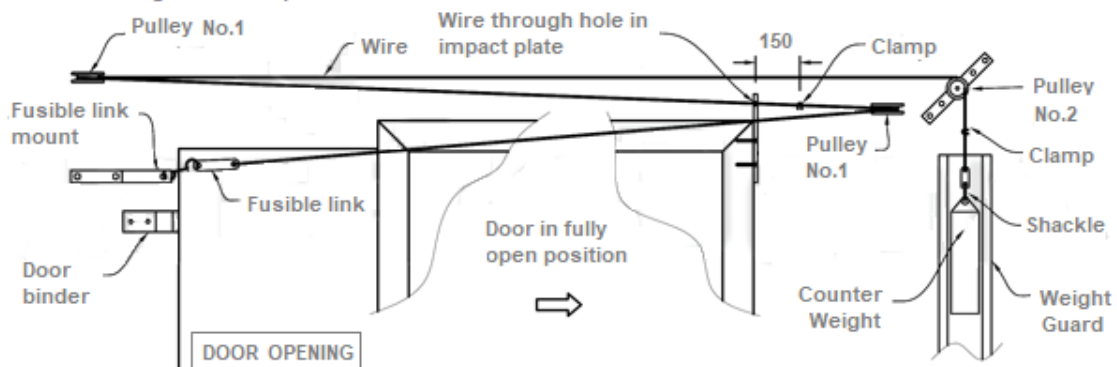

WALL TYPE: MASONRY

FRAME TYPE: SLIDER

FUSIBLE LINK SYSTEM

-counterweight near to open side

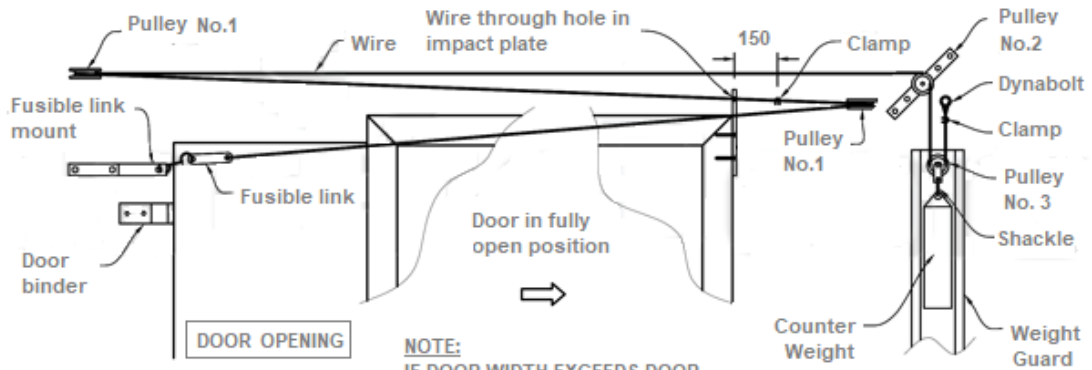

NOTE:
IF DOOR WIDTH EXCEEDS DOOR
HEIGHT, COUNTERWEIGHT PULLEY
(No. 3) IS REQUIRED (AS SHOWN)