

Fundo Primo (Nautilo, Trollo, Borgo)

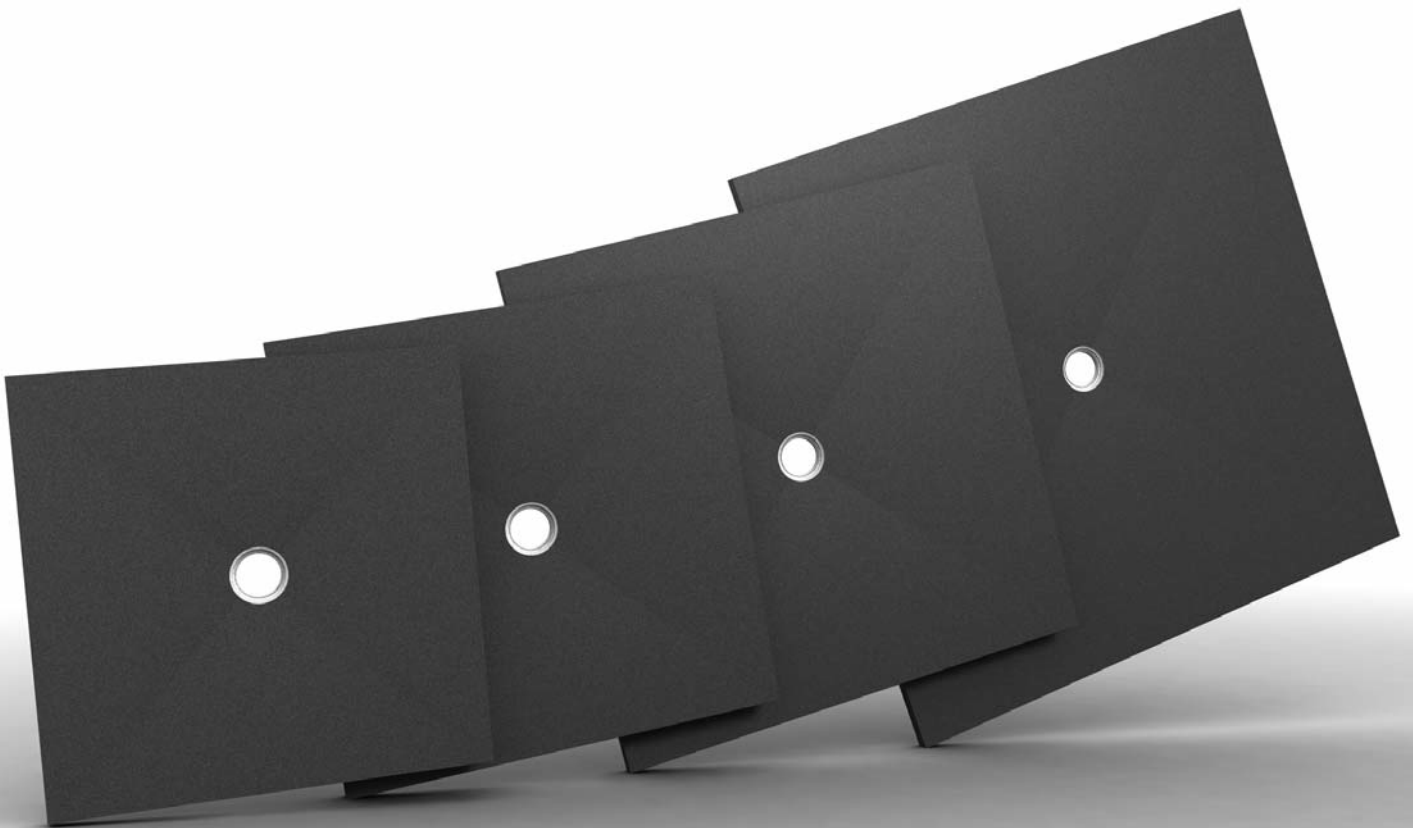

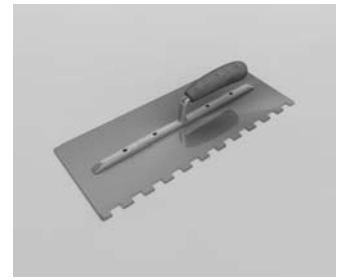

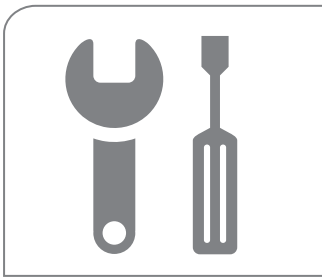
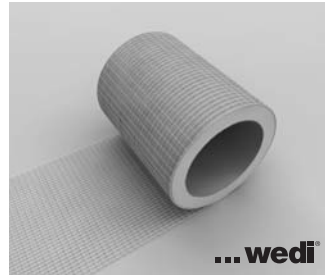
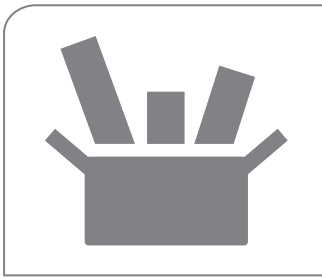
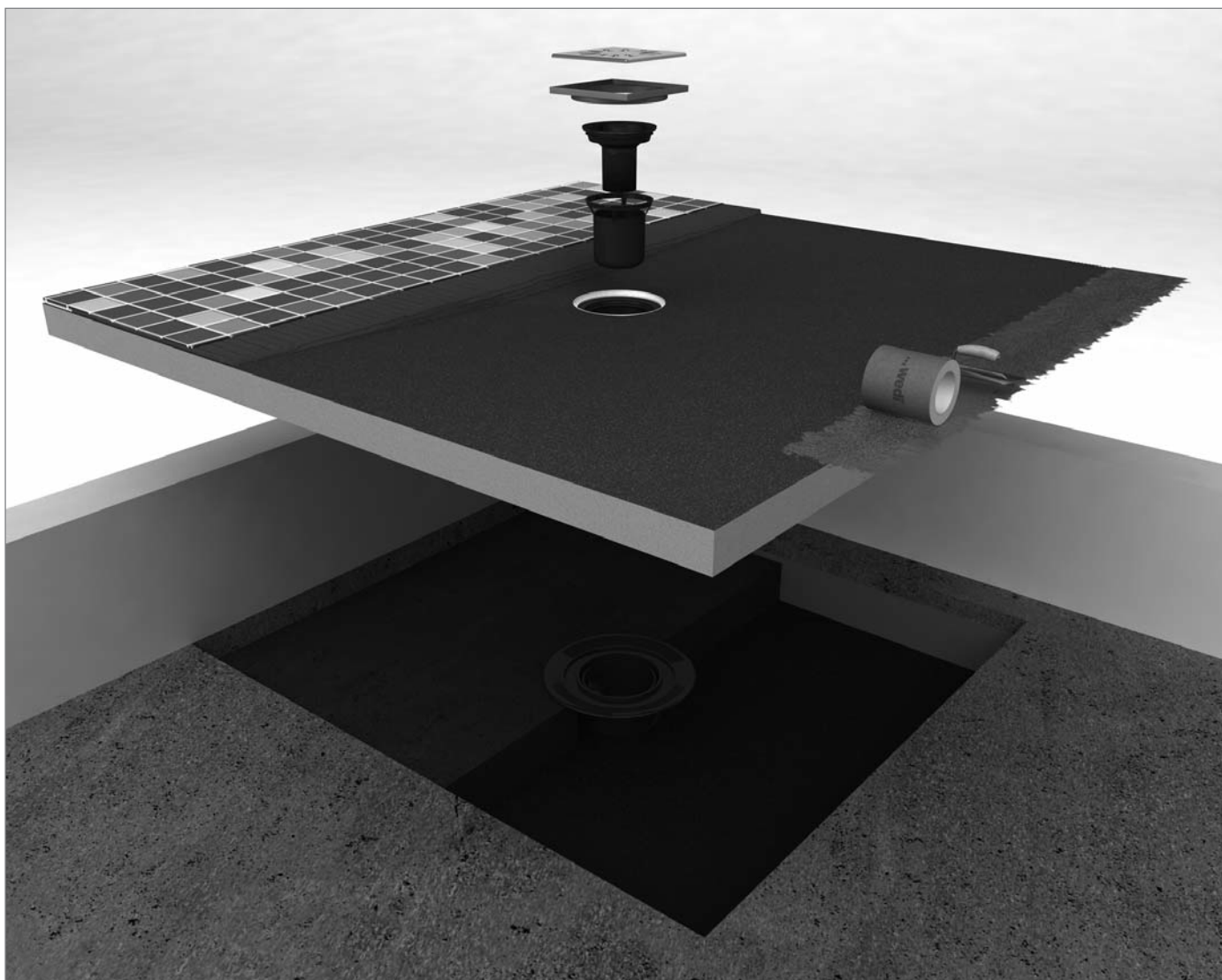

0799 (System 2+)

wedi GmbH
Hollefeldstraße 51
48282 Ermsdetten
13
0799-CPD-132
DoP 0001

ETA-13/0385
ETAG 022 Teil 3

Bausatz mit wasserdichten Platten und weiteren Komponenten zur Herstellung einer Abdichtung unter einer Nutzschrift für die Verwendung in innen liegenden Nassbereichen
Klassifizierung des Systems und deklarierte Produkt- und Systemeigenschaften siehe Anhang 1 der ETA-13/0385

A

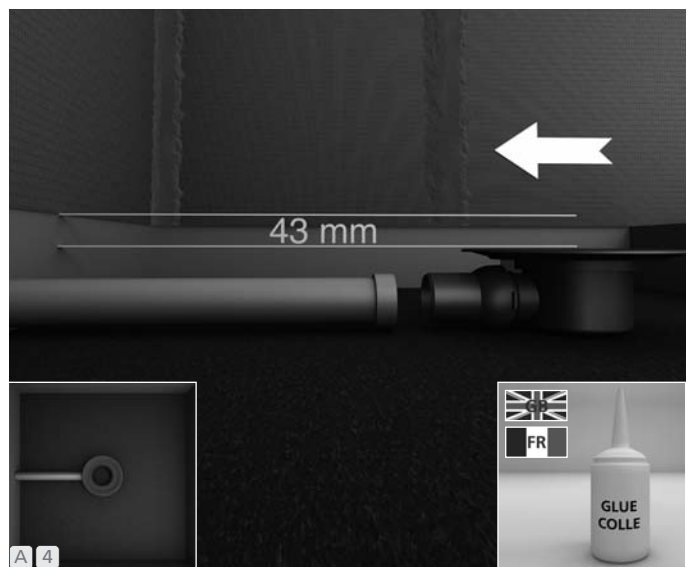
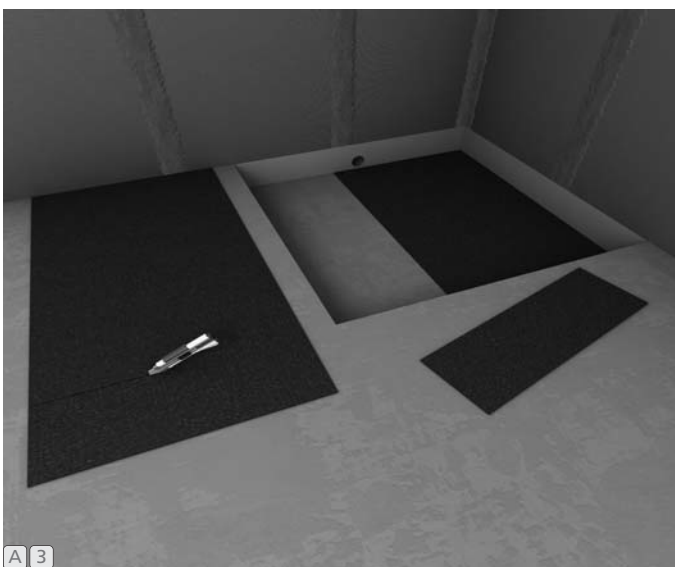
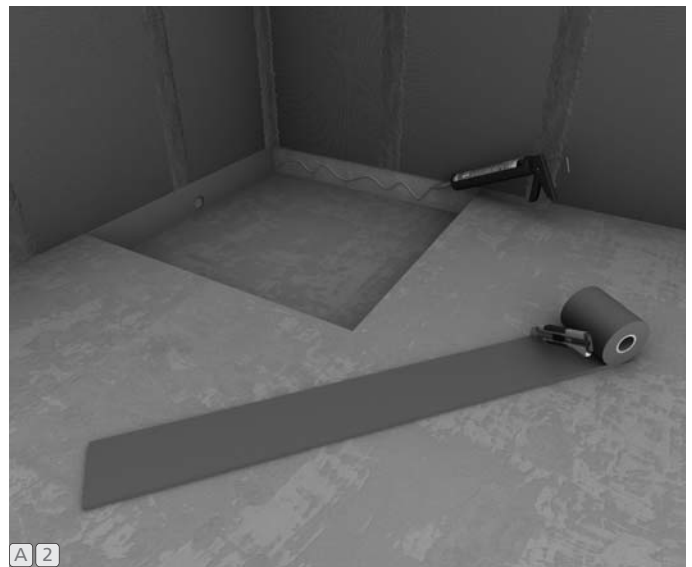
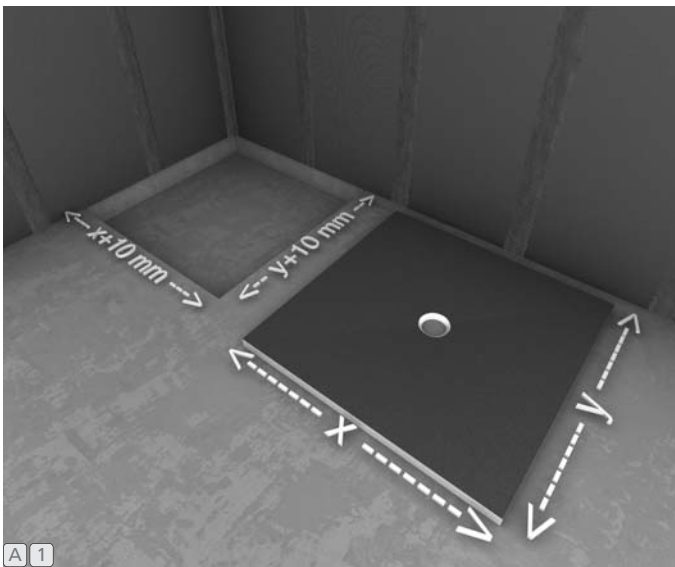
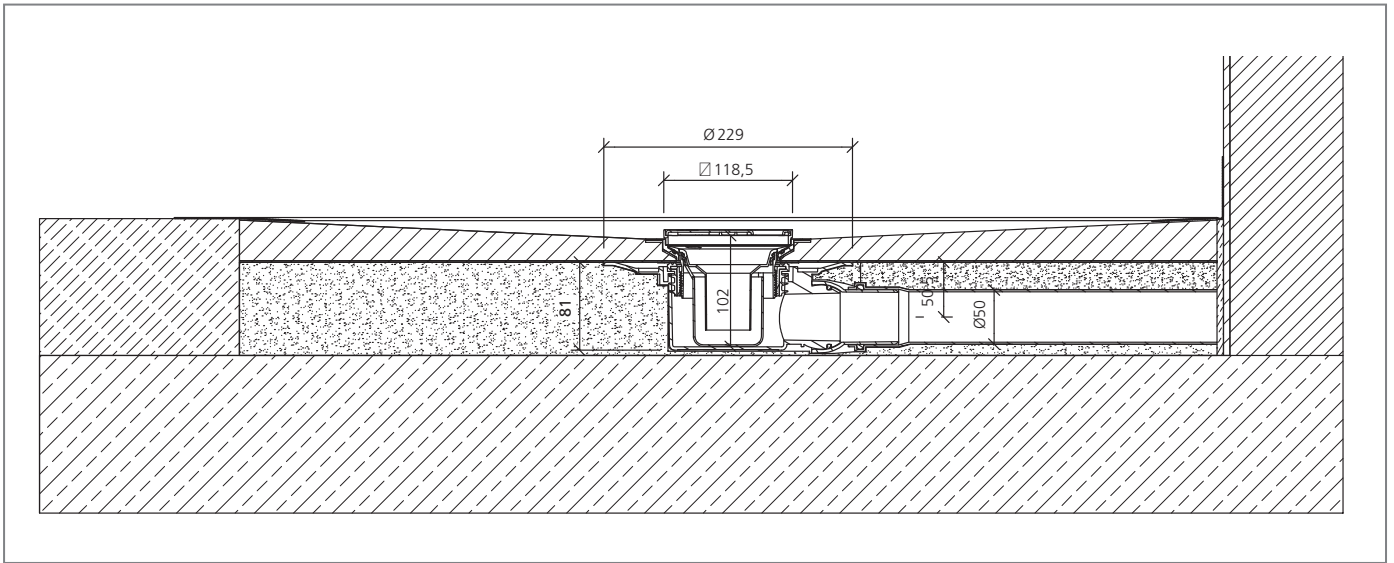

B

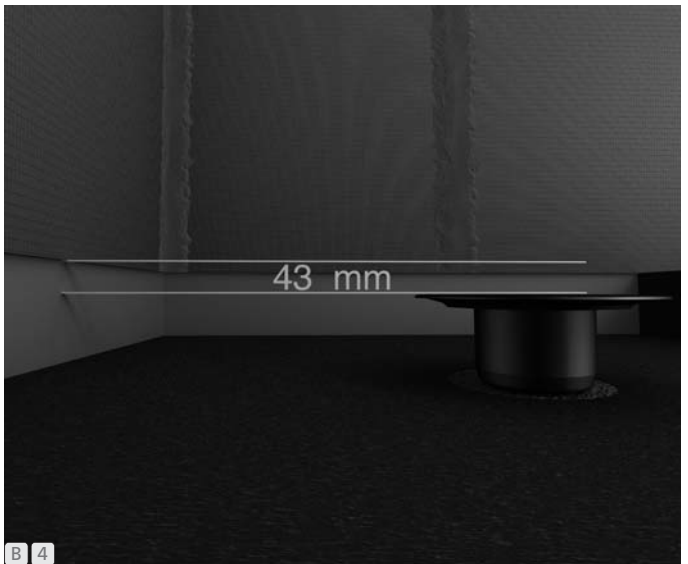
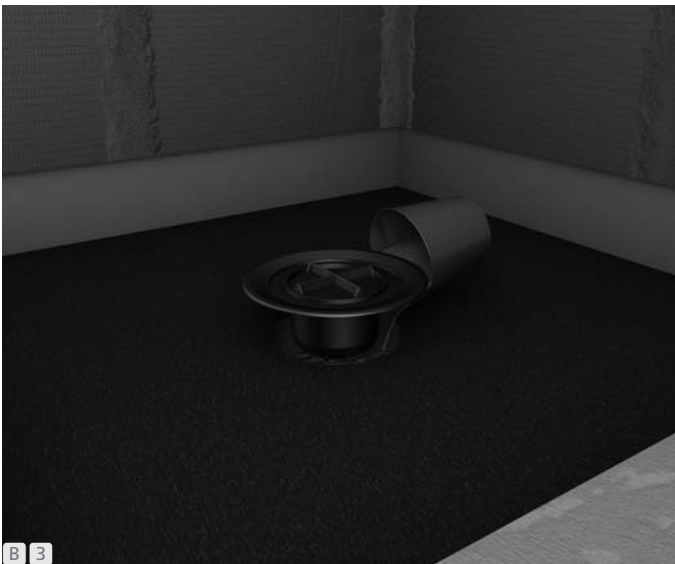
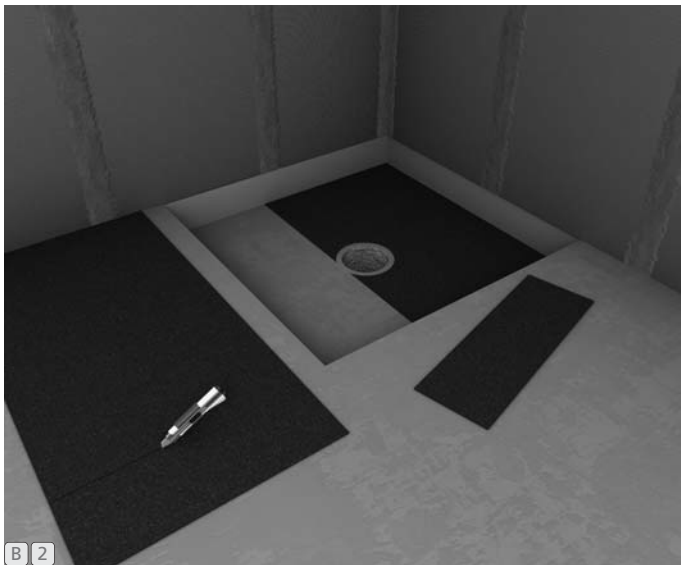
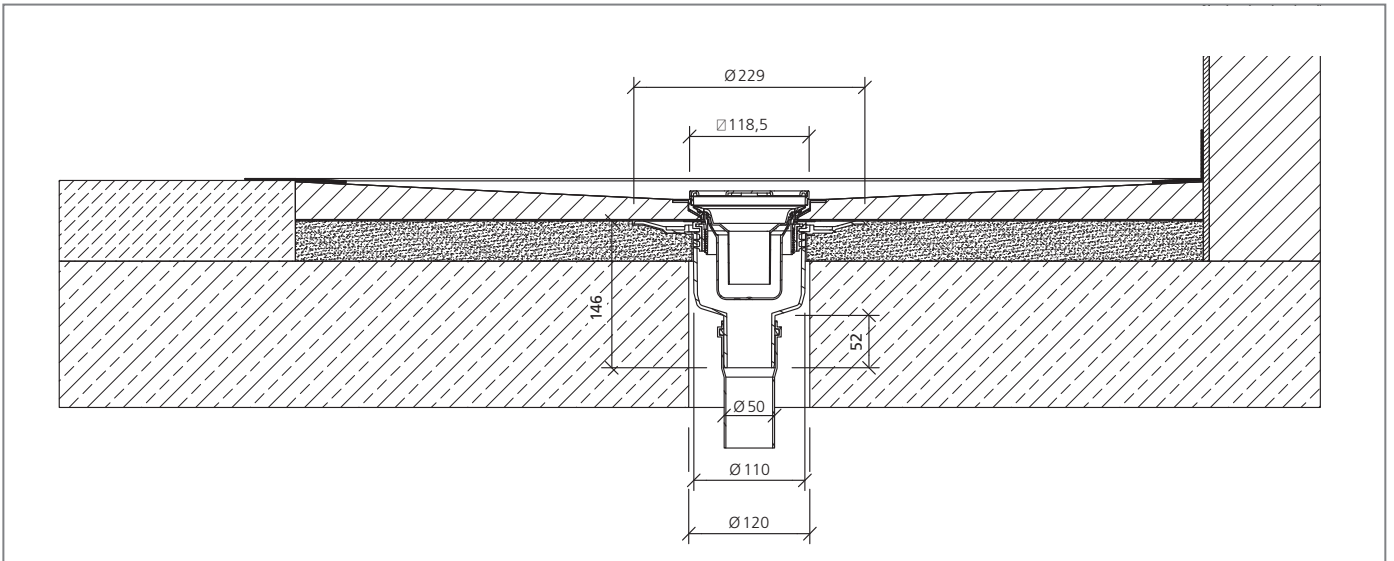

C

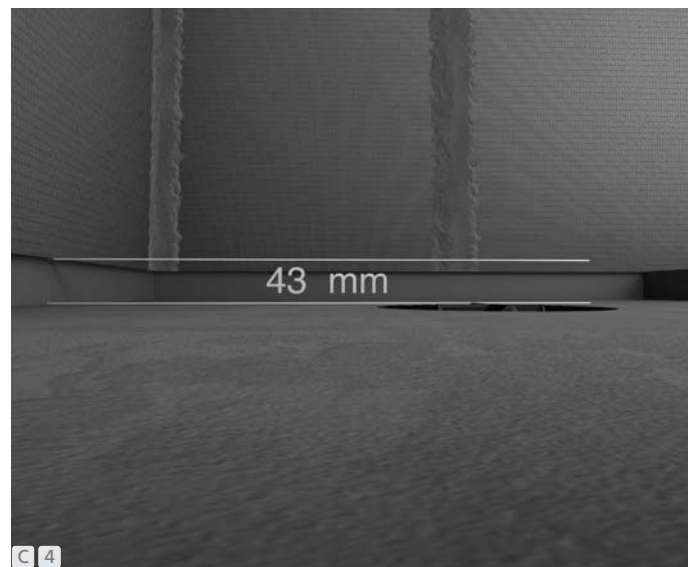
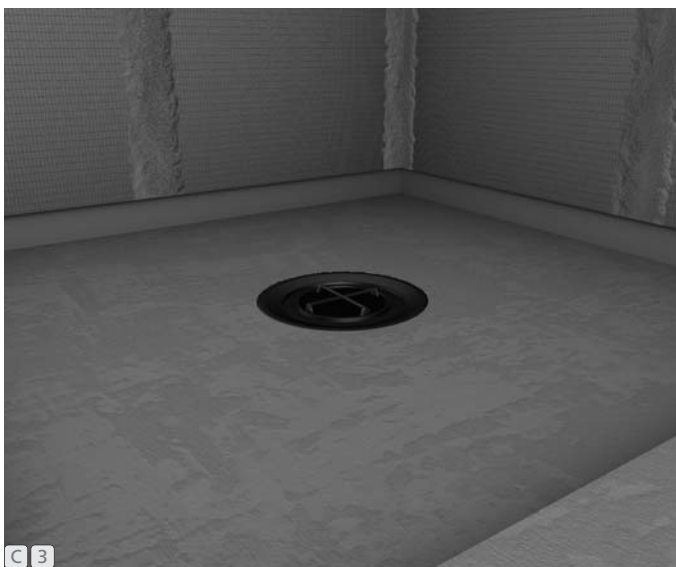
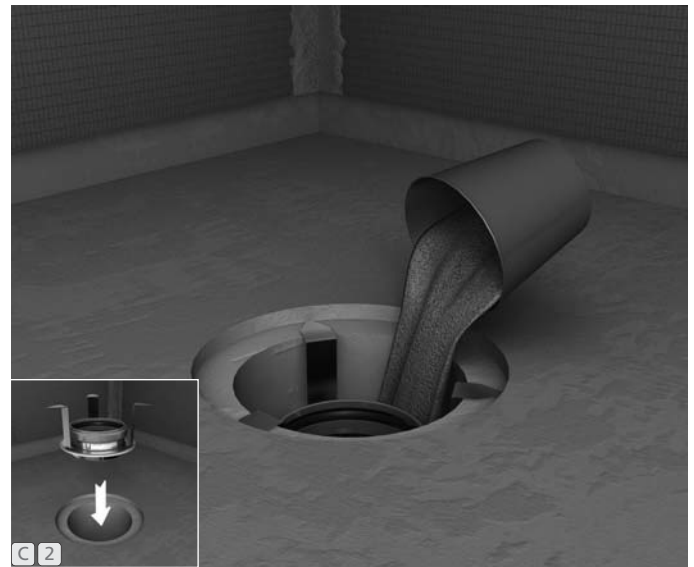
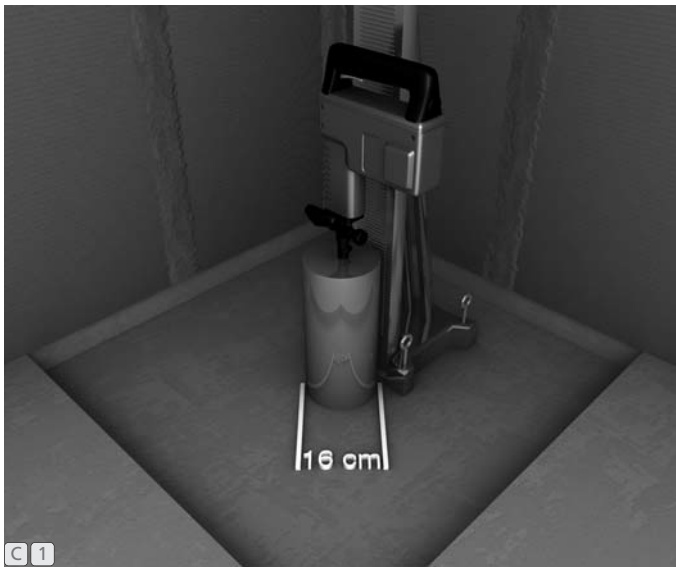
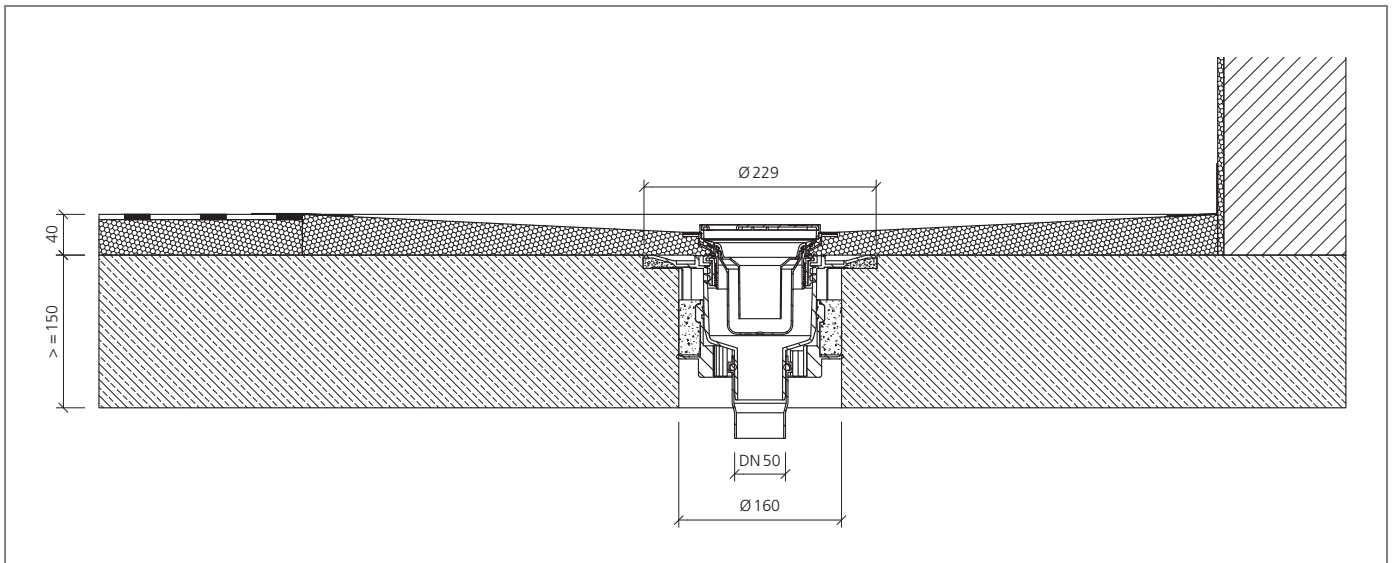

A, B, C

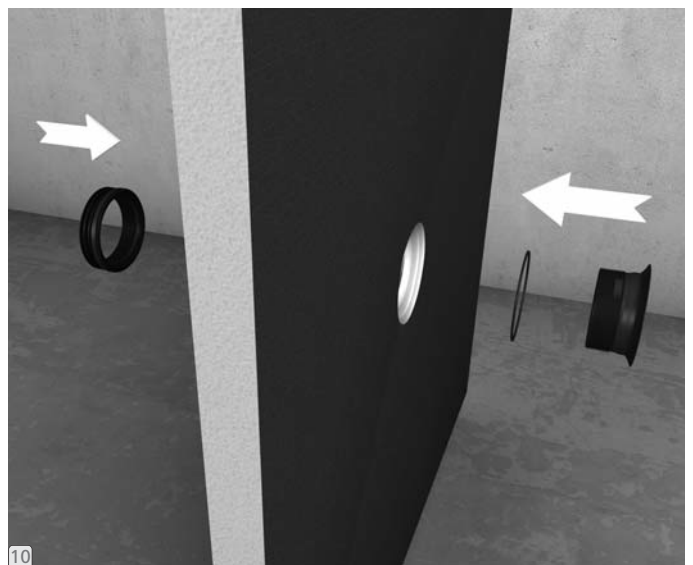
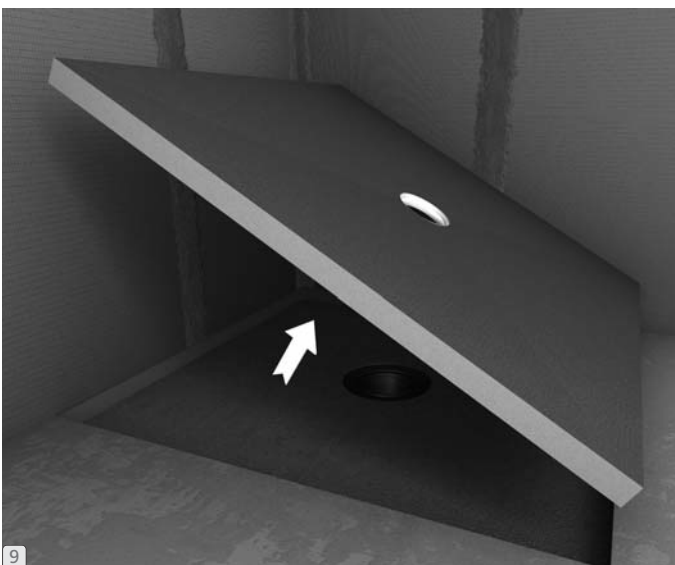
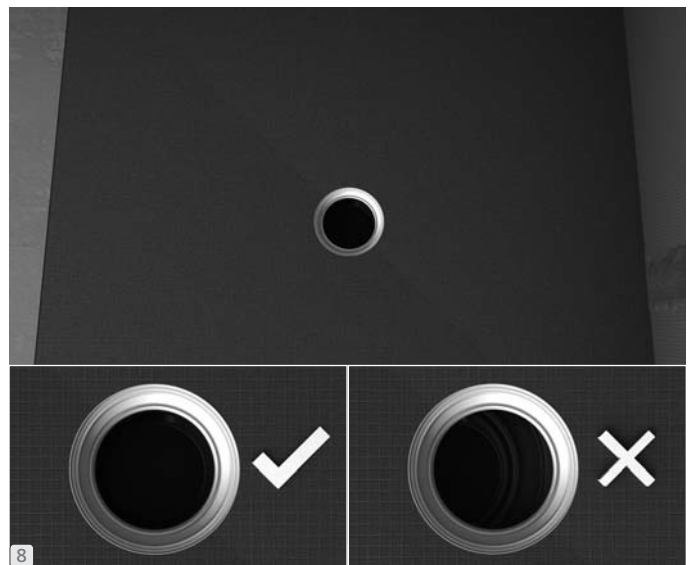
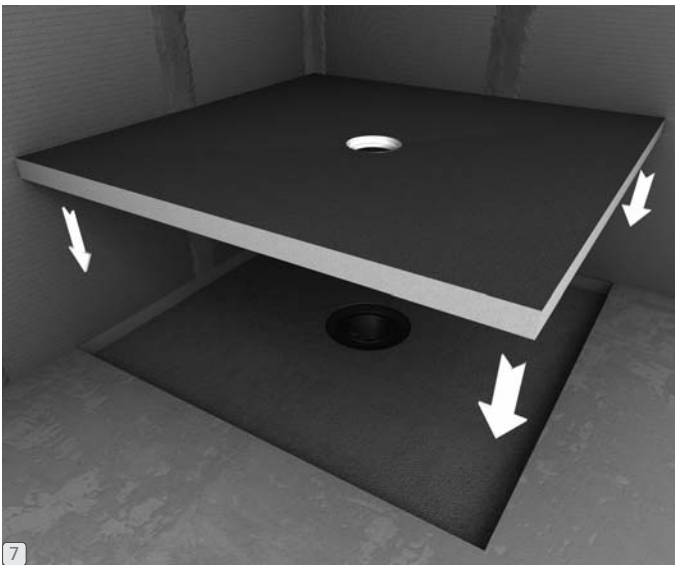
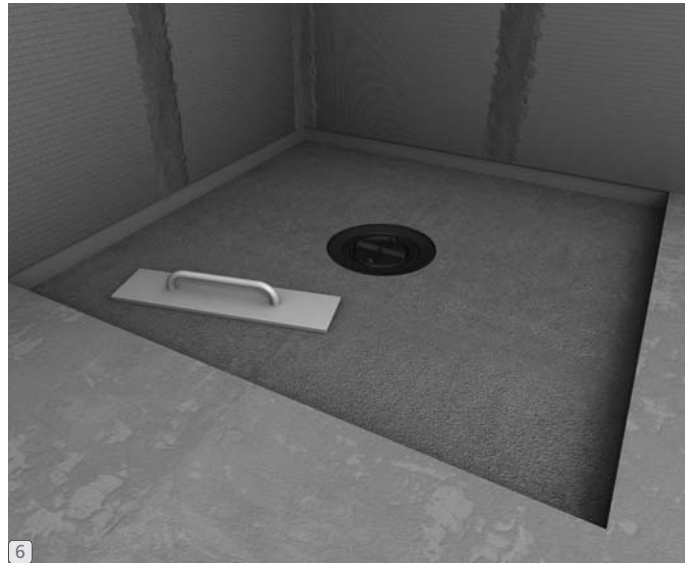
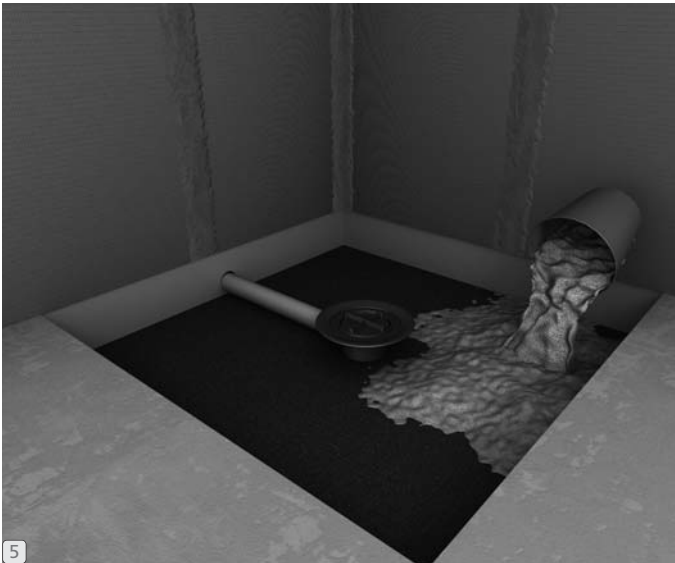

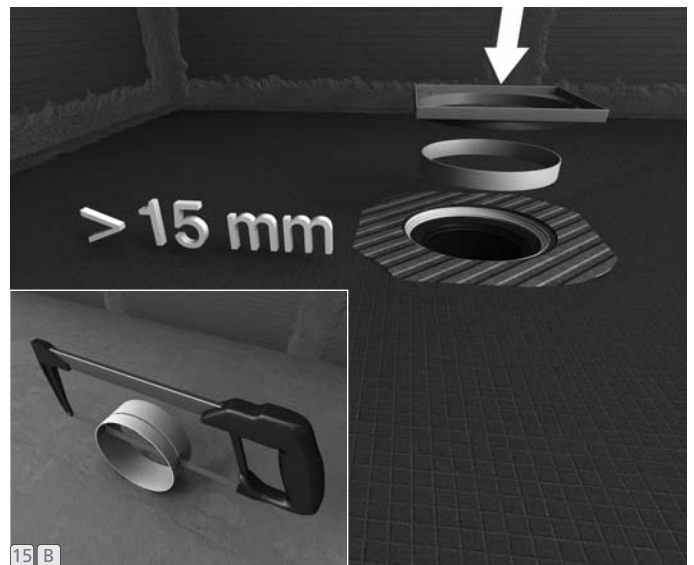
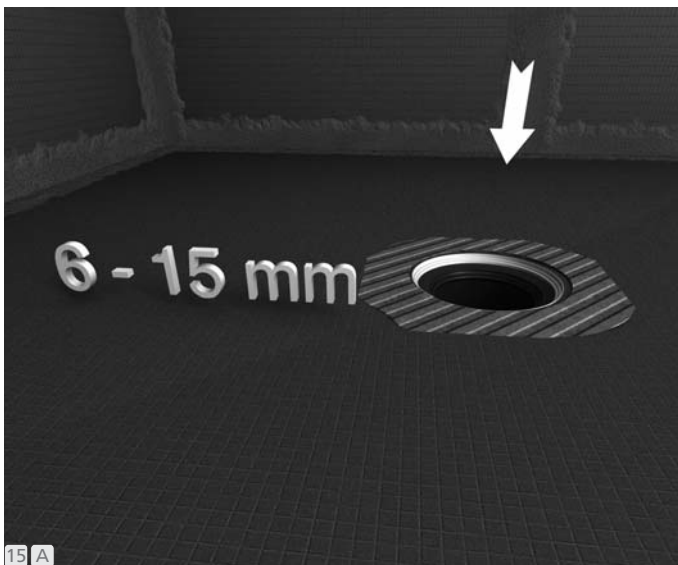
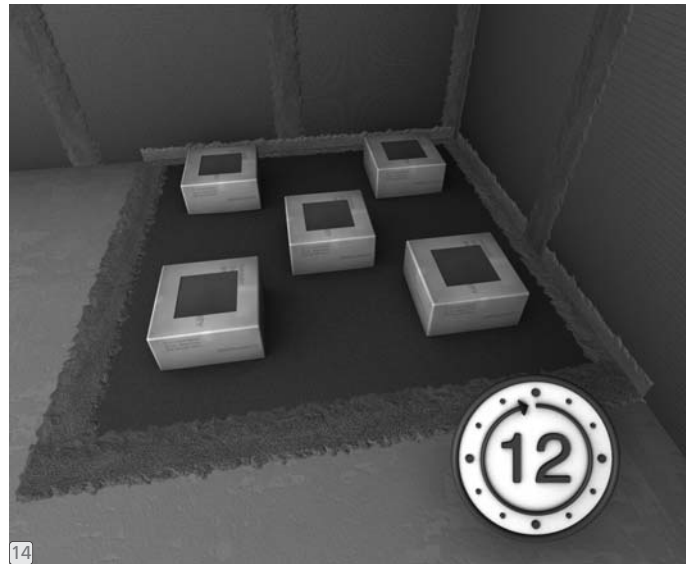
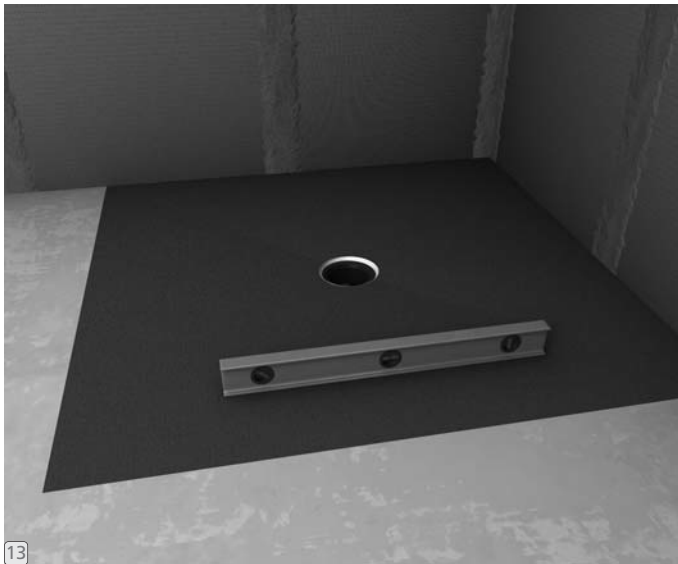
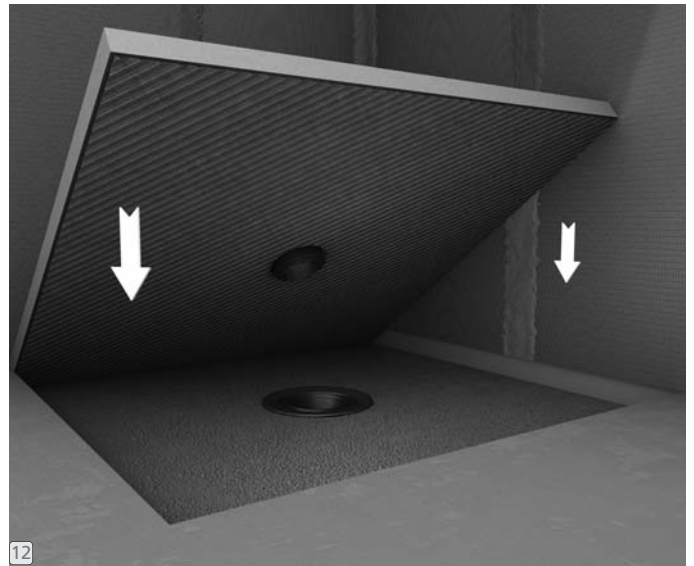
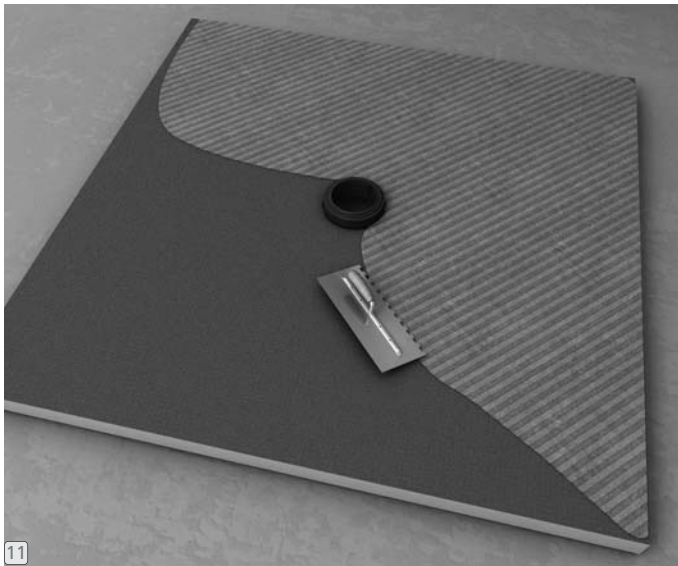

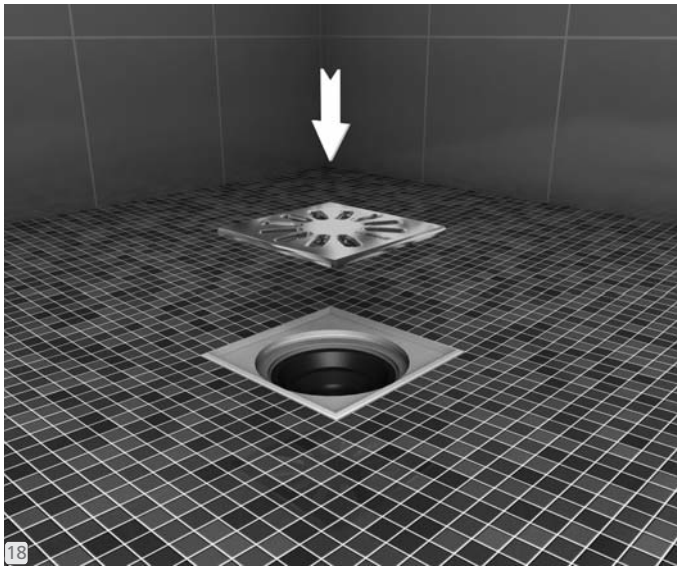
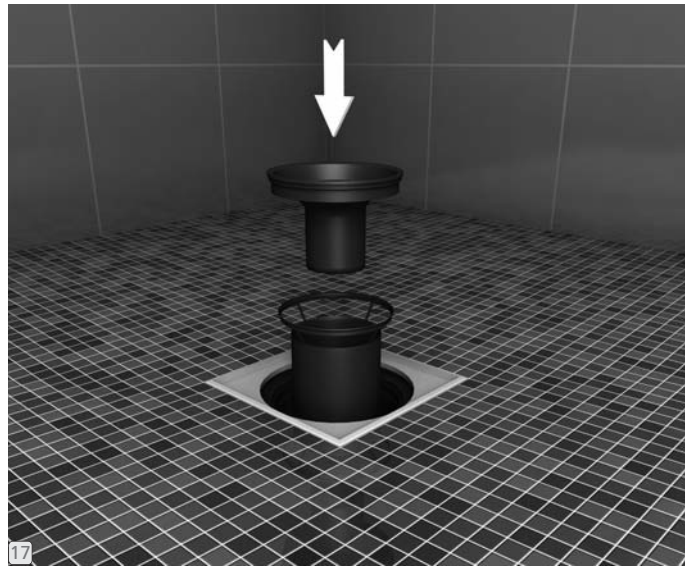
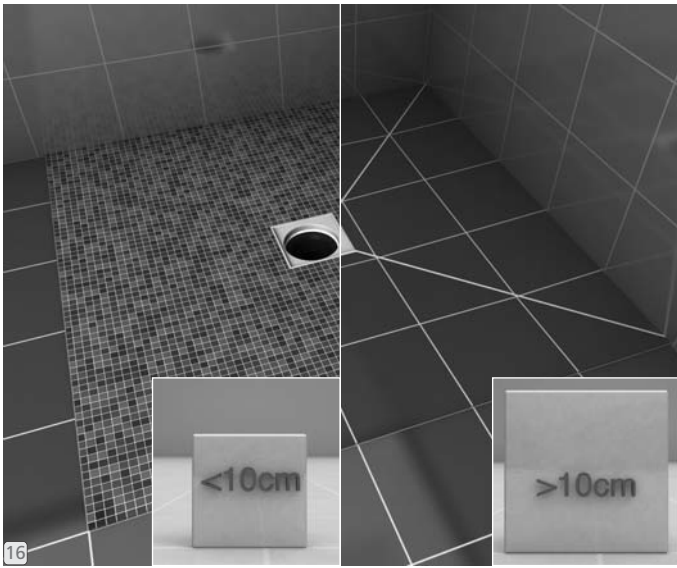

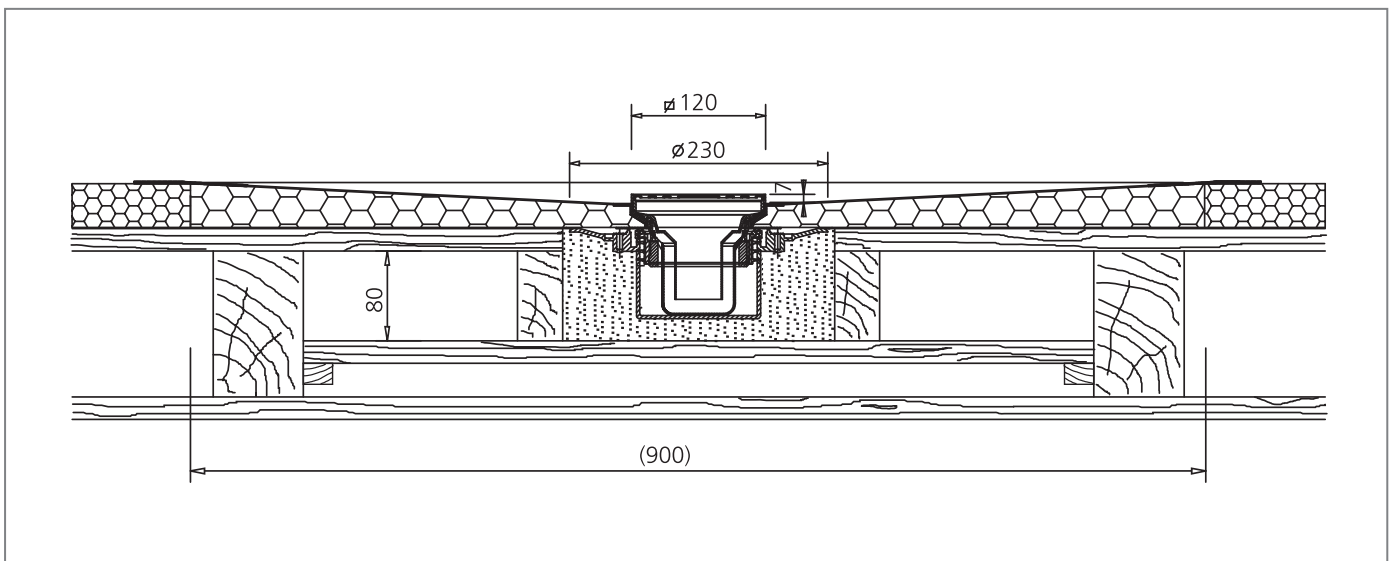
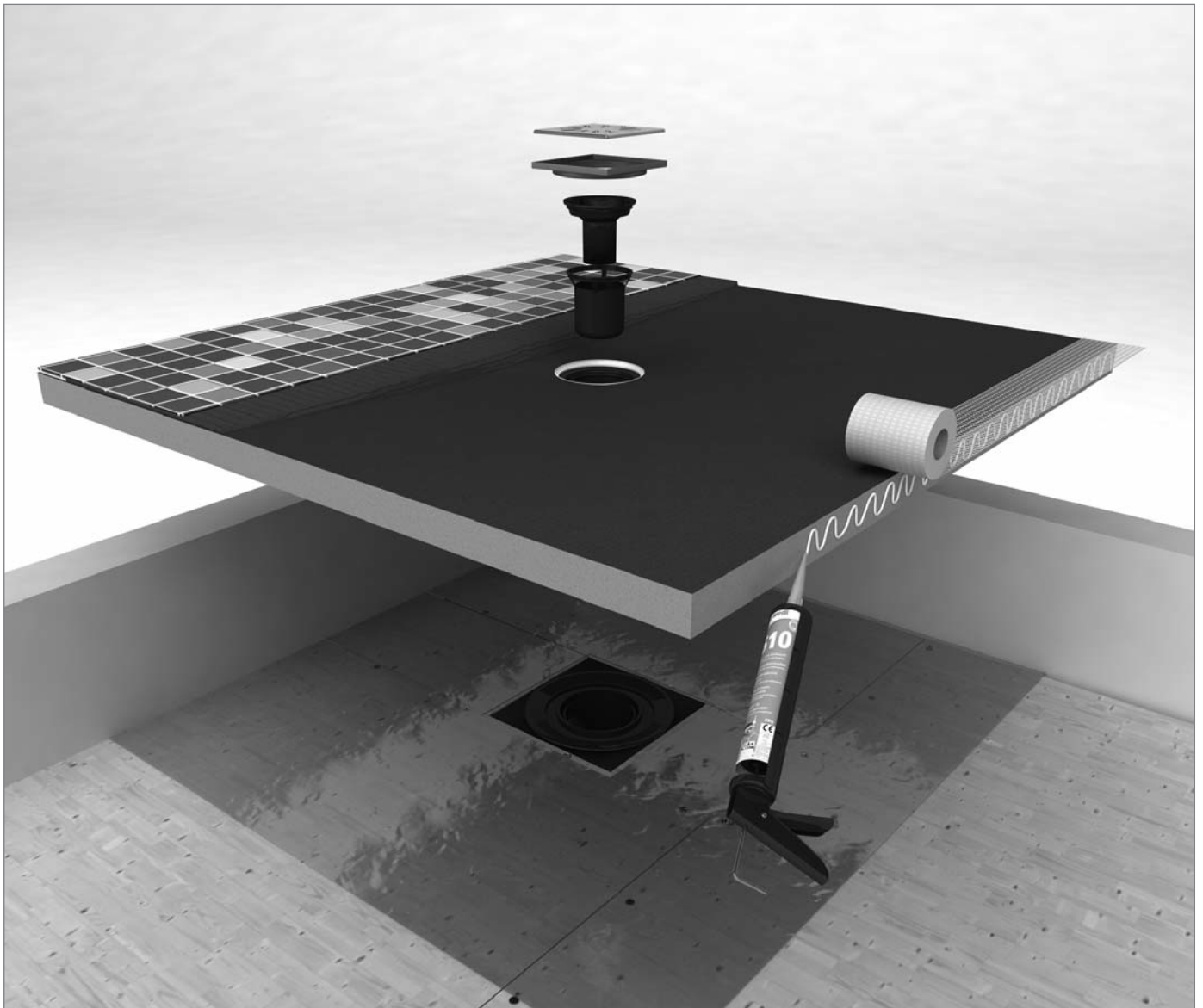

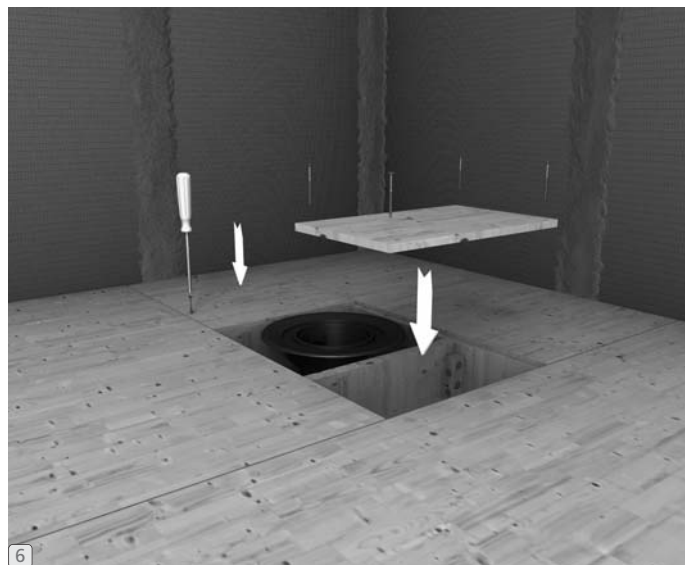
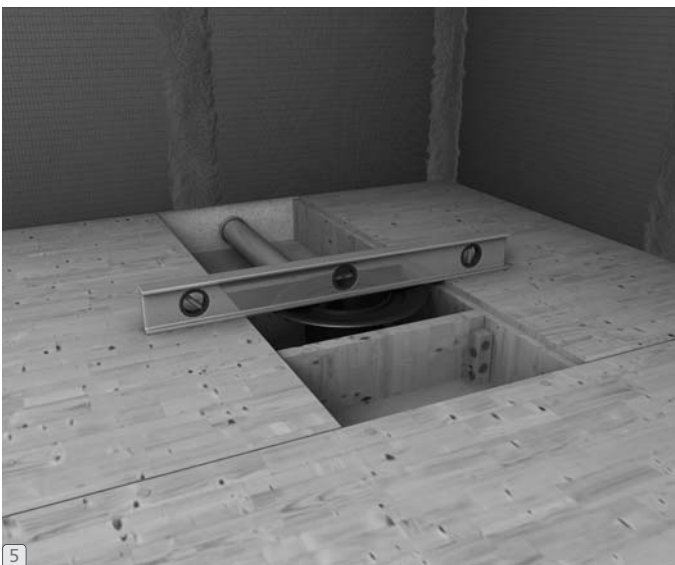
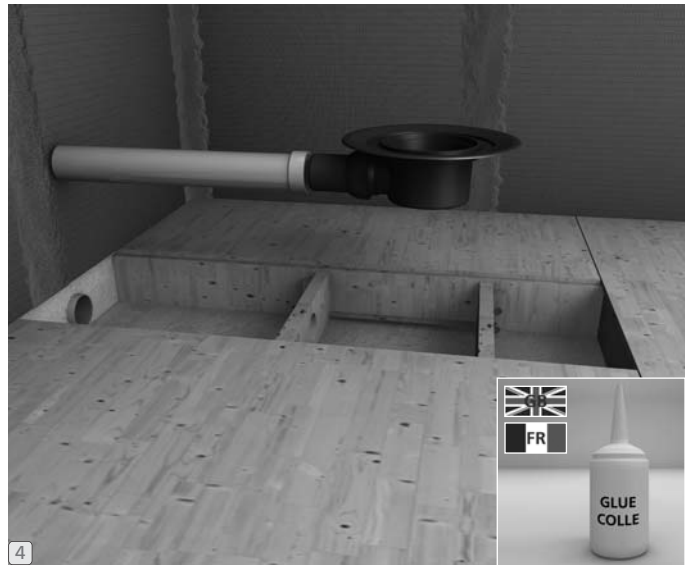
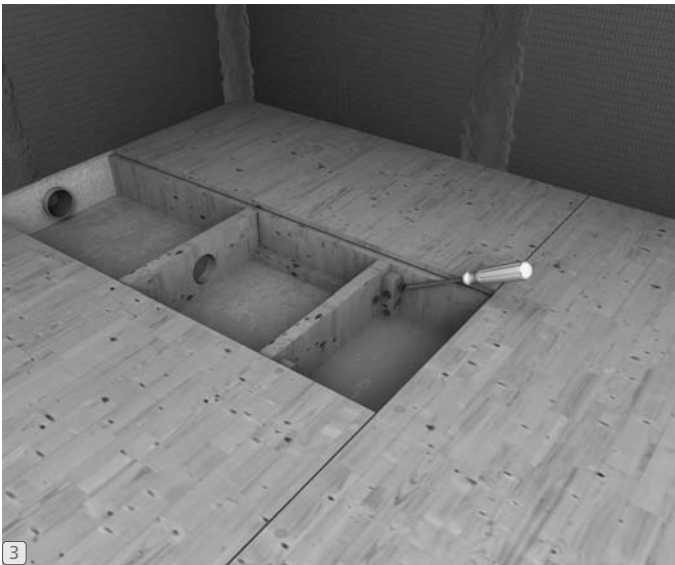
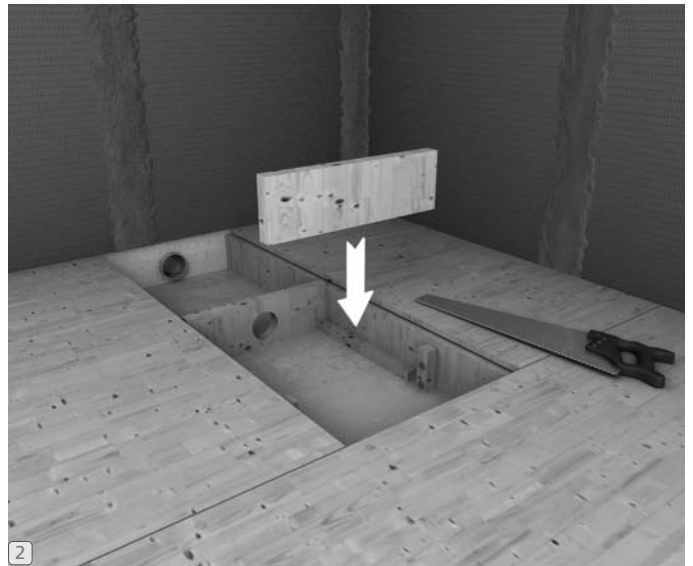
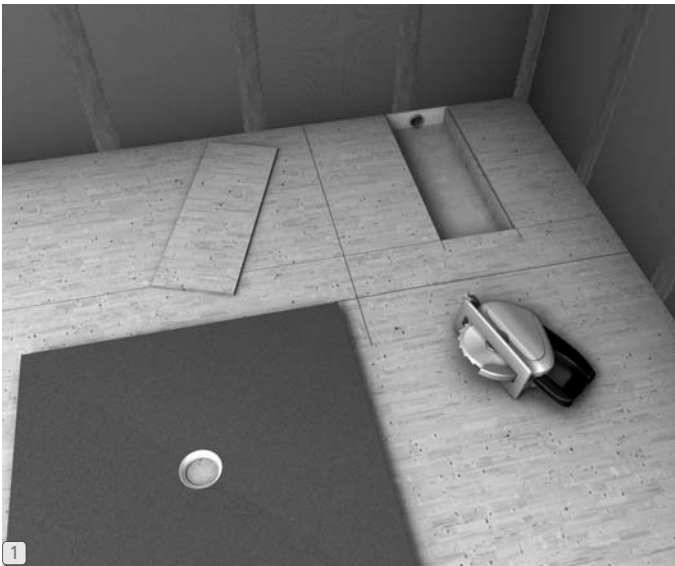

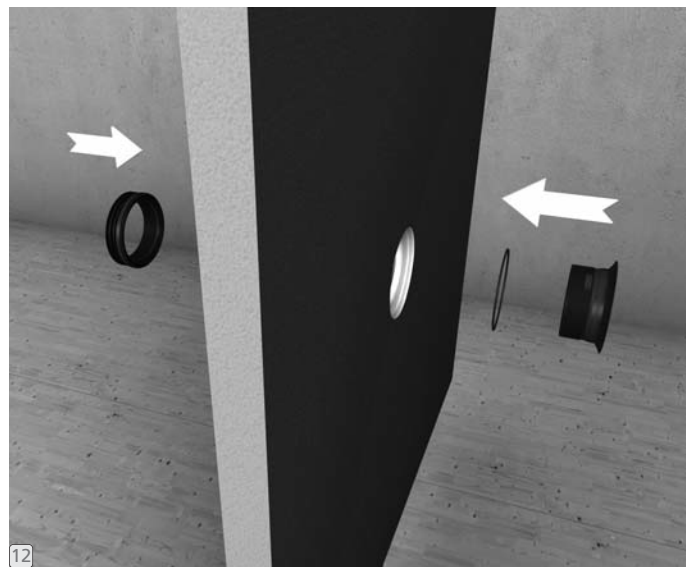
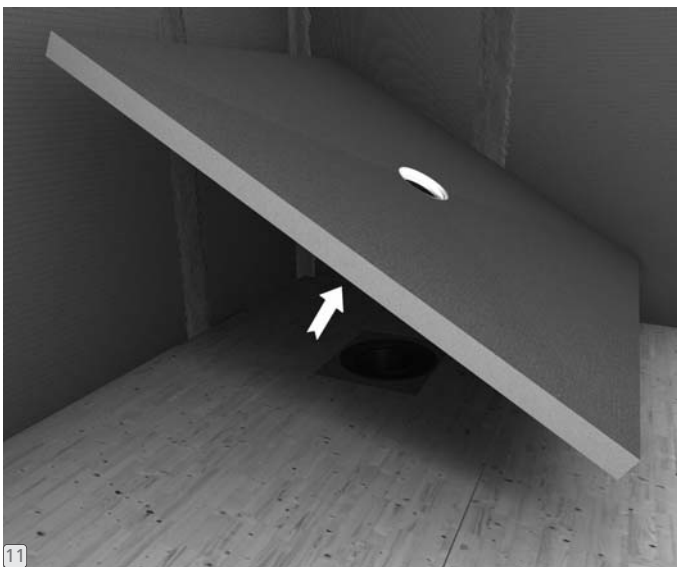
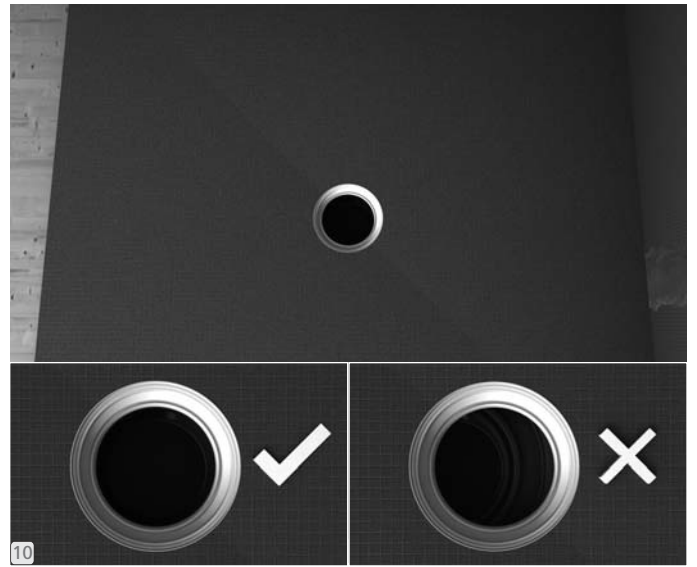
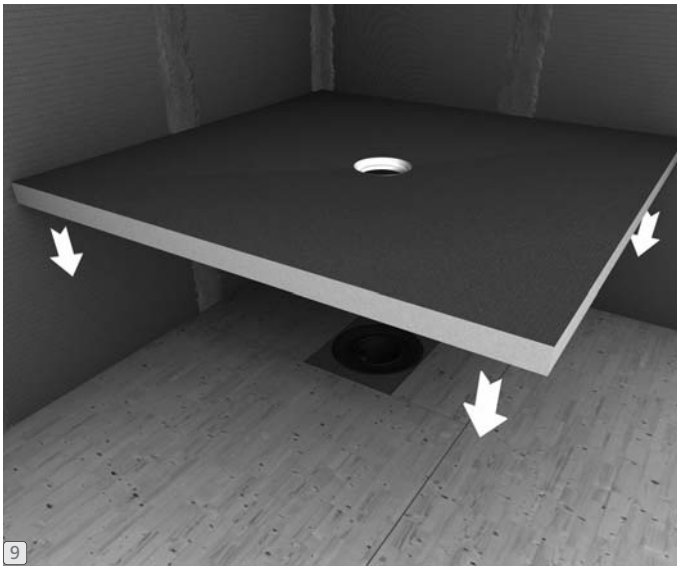
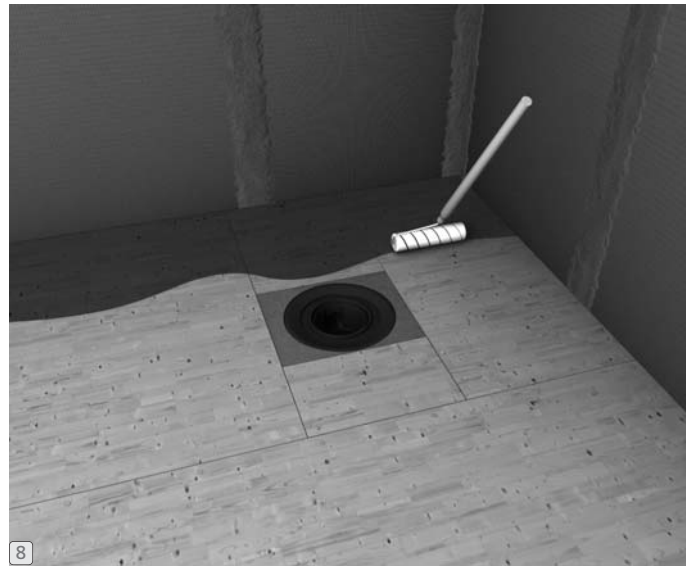

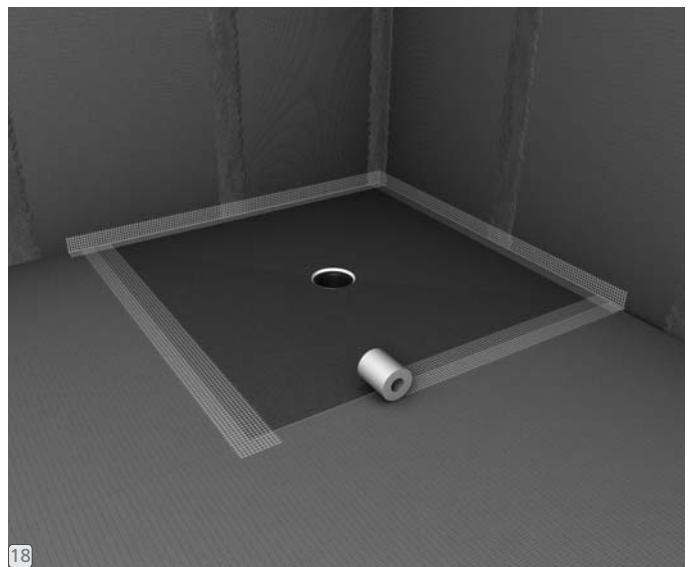
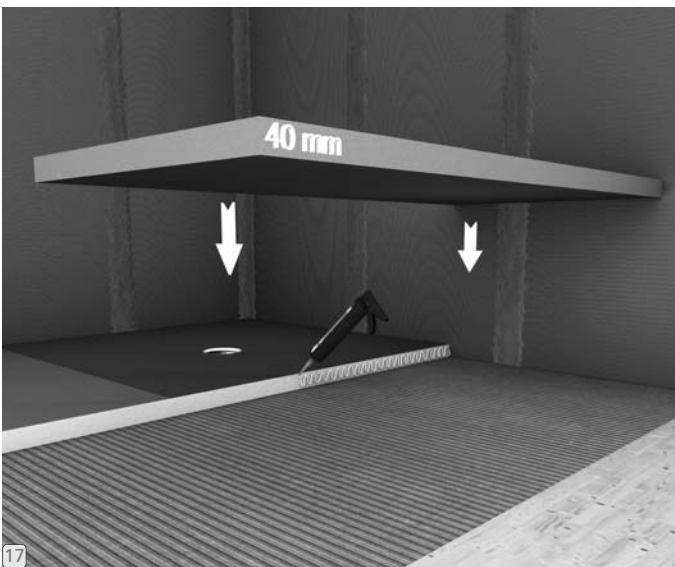
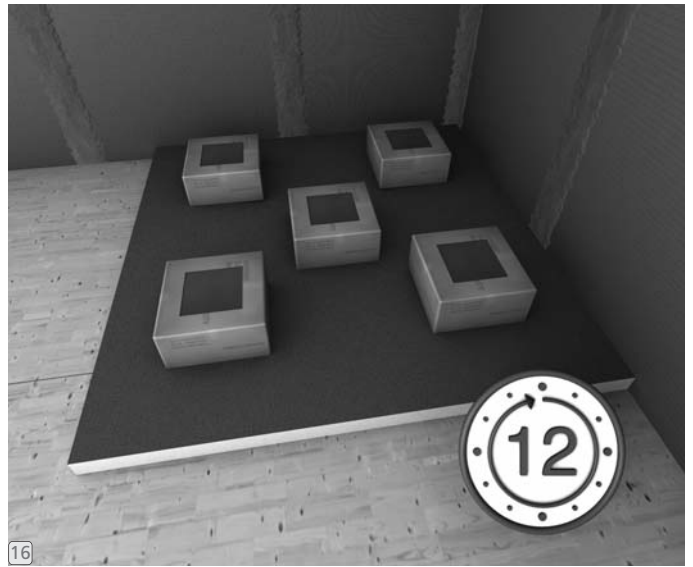
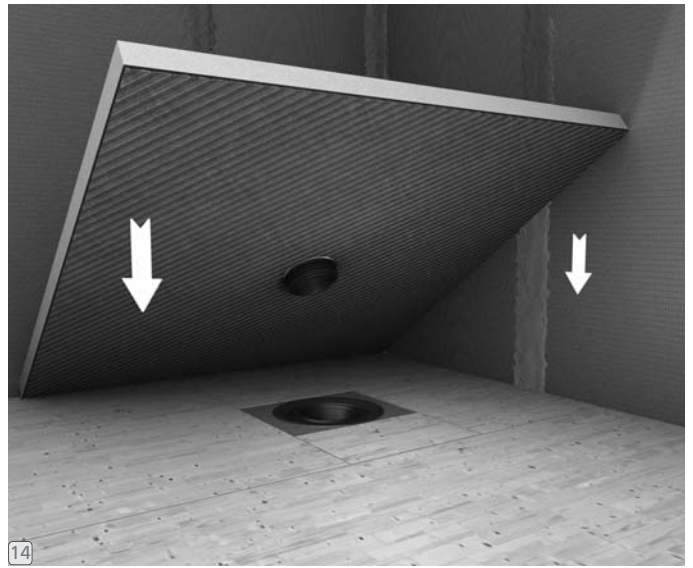
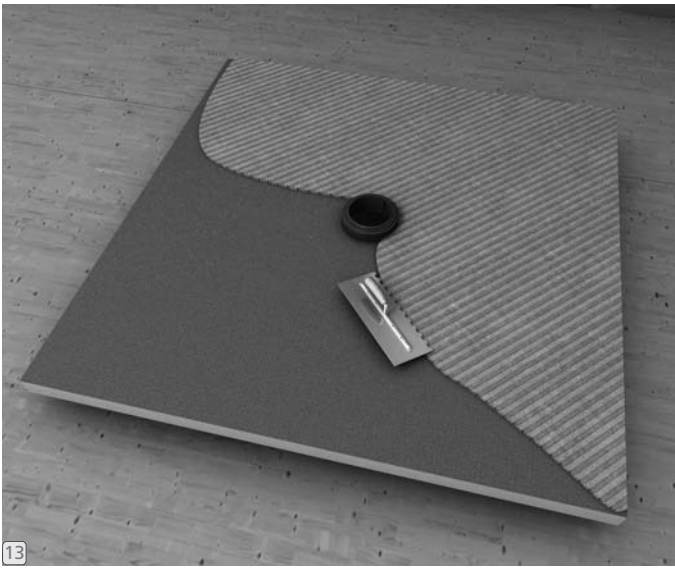

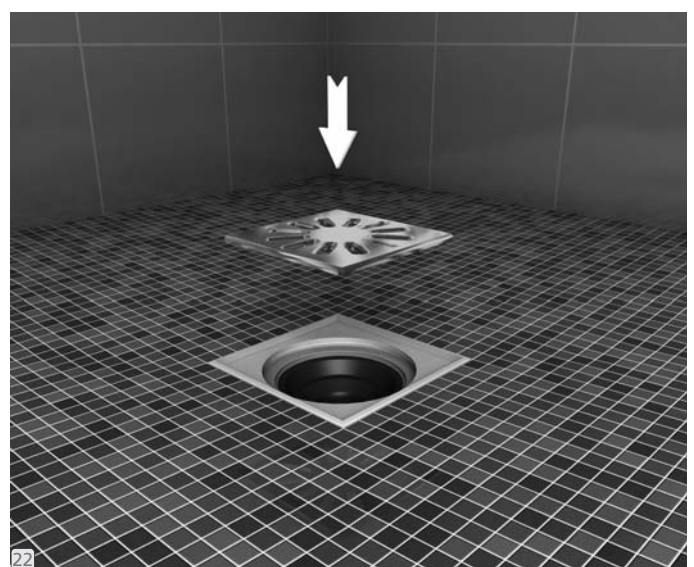
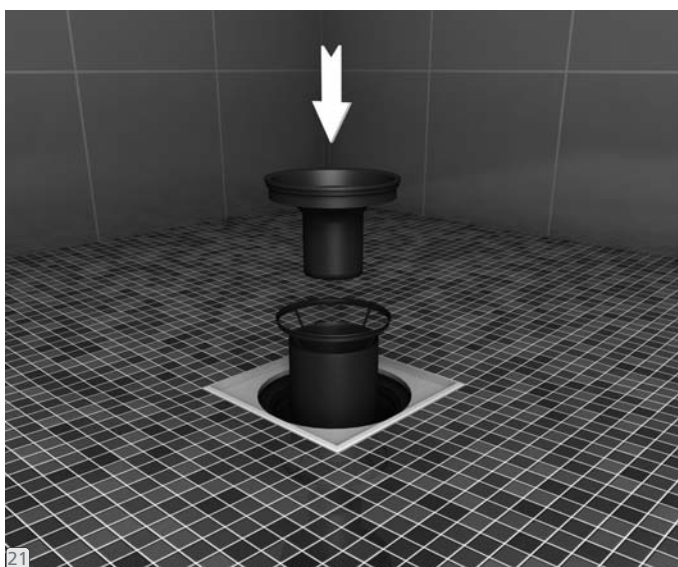
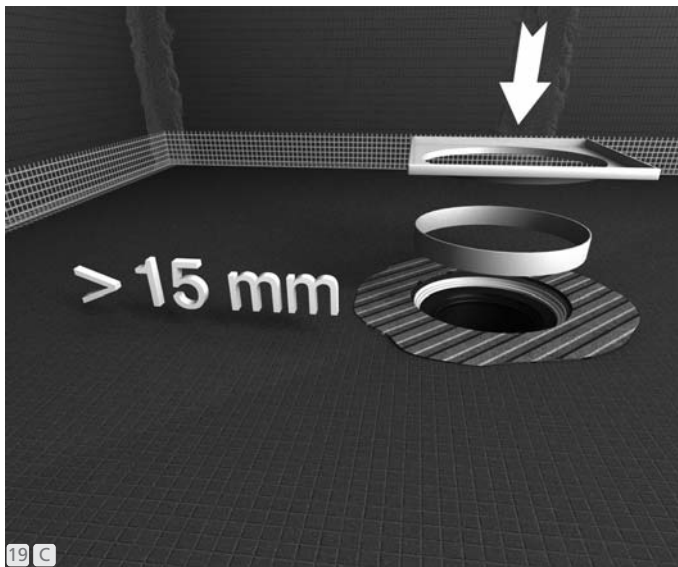
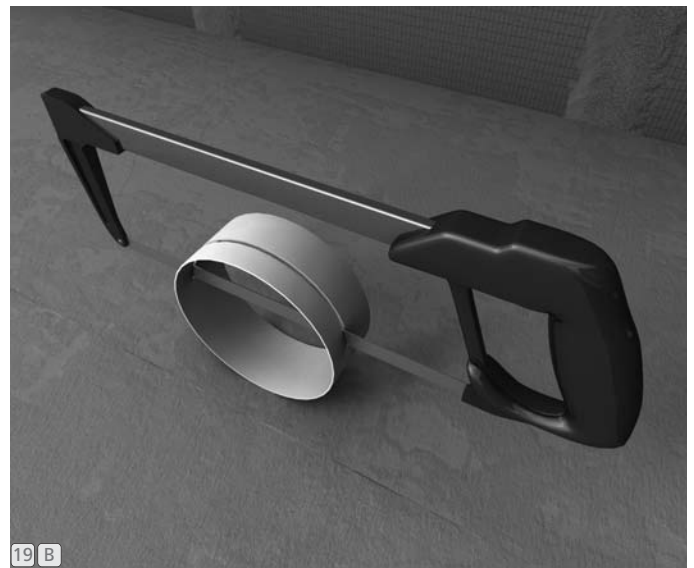
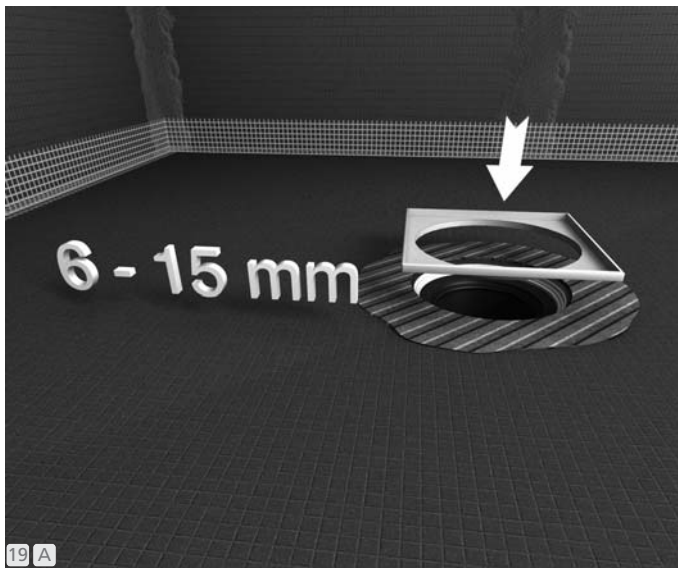

... **wedi**[®]

wedi GmbH
Hollefeldstraße 51 · D-48282 Emsdetten
Tel. +49 2572 156-0 · Fax +49 2572 156-133
info@wedi.de · www.wedi.eu