



Cisco Unified IP Phone 6921, 6941, 6945, and 6961 User Guide for Cisco Unified Communications Manager Express Version 9.0 (SIP)

First Published: November 11, 2011

Last Modified: December 08, 2011

Americas Headquarters

Cisco Systems, Inc.
170 West Tasman Drive
San Jose, CA 95134-1706
USA
<http://www.cisco.com>
Tel: 408 526-4000
800 553-NETS (6387)
Fax: 408 527-0883

Text Part Number: OL-25524-01

Cisco and the Cisco logo are trademarks or registered trademarks of Cisco and/or its affiliates in the U.S. and other countries. To view a list of Cisco trademarks, go to this URL: <http://www.cisco.com/go/trademarks>. Third-party trademarks mentioned are the property of their respective owners. The use of the word partner does not imply a partnership relationship between Cisco and any other company. (1110R)

© 2011 Cisco Systems, Inc. All rights reserved.



CONTENTS

Overview 1

Physical Description of Cisco Unified IP Phone 6921 2

Physical Description of Cisco Unified IP Phone 6941 4

Phone Screen 6

Phone Connections 7

Footstand 8

Adjusting the Handset Rest 9

Physical Description of Cisco Unified IP Phone 6945 10

Phone Screen 13

Phone Connections 14

Footstand 15

Higher Viewing Angle 15

Lower Viewing Angle 16

Adjusting the Handset Rest 17

Physical Description of Cisco Unified IP Phone 6961 18

Phone Screen 20

Phone Connections 20

Footstand 21

Adjusting the Handset Rest 22

Operating Your Phone 25

Soft Key Descriptions 26

Access Services 28

Ad-hoc Conference 28

Adjust the Display Contrast 29

Adjust the Ring Volume 29

Answer a Call 30

Auto Answer 30

cBarge 30

Call History 30

Clear Call History	31
Edit Number From Call History	31
Delete a Call Record From Call History	32
Filter Call History	32
Place a Call from Call History	32
View Call History	33
View Call Record Details	33
Call Forward All	33
Call Park	34
Park and Retrieve a Call Using Call Park	34
Park and Retrieve a Call using Assisted Direct Call Park	35
Park and Retrieve a Call Using Manual Directed Call Park	36
Call Pickup	36
Answer a Call Using Pickup	37
End a Call	37
Extension Mobility	37
Enable Extension Mobility	38
Establish/End a Conference Call	38
Forward All Calls	39
Hold/Resume a Call	39
Intercom	39
Place an Intercom Call	40
Receive an Intercom Call	40
Manage Call Waiting	40
Mobility	40
Mute a Call	41
My Phone Apps	41
Phone Applications	42
Phone Directory	42
Search for and Dial a Contact	42
Search for and Dial a Contact while on a Call	43
Place a Call	43
Place a MeetMe Conference Call	44
Privacy	44
Redial a Number	44

Select the Ringtone	44
Shared Lines	45
Sign In and Out of a Hunt Group	46
Speed Dial	46
Set up Speed-Dial Buttons	46
Speed-Dial Button	47
Transfer a Call	47
Consultative Transfer	47
Cancel Transfer	47
View Phone Information	48
Voice Messages	48
Check for Voice Messages	48
Listen to Voice Messages	49
Personalize Your Voicemail	49



CHAPTER 1



Overview





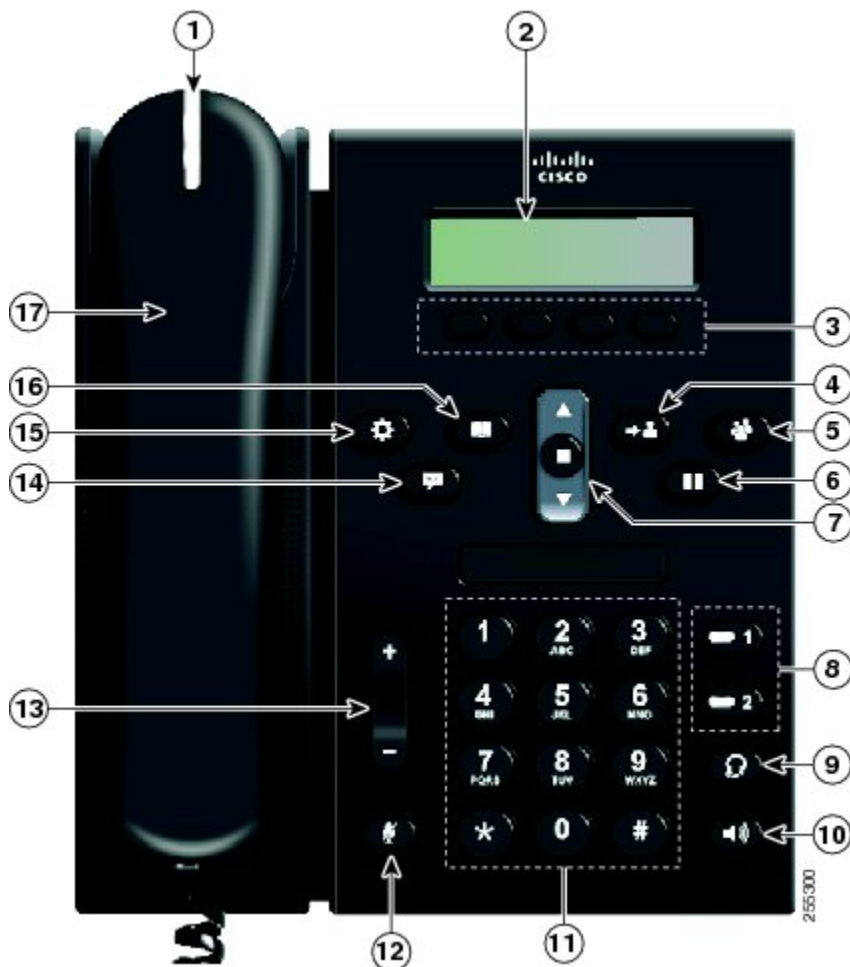

This guide provides phone operating instructions and feature descriptions for the Cisco IP Phone multiline models 6921, 6941, 6945, and 6961. The Cisco IP Phone 6921 has two lines, the Cisco IP Phone 6941 and 6945 have four lines, and the Cisco IP Phone 6961 has twelve lines.





- [Physical Description of Cisco Unified IP Phone 6921, page 2](#)
- [Physical Description of Cisco Unified IP Phone 6941, page 4](#)
- [Physical Description of Cisco Unified IP Phone 6945, page 10](#)
- [Physical Description of Cisco Unified IP Phone 6961, page 18](#)

Physical Description of Cisco Unified IP Phone 6921







	Name	Description
1	Handset with indicator light	Functions as traditional handset and indicates an incoming call (flashing red) or new voice message (steady red).
2	LCD screen	Displays information such as incoming/outgoing call status, directories, line status, phone configuration options, and soft key tabs. Also, shows dedicated phone line labels.
3	Soft key buttons 	Depending on how your system administrator sets up the phone, enable soft key options displayed on your phone screen.
4	Transfer button 	Transfers active calls to another extension.









	Name	Description
5	Conference button 	Initiates the conference call.
6	Hold button 	Places the call on hold.
7	Navigation Bar and Select (center) button 	The navigation bar allows you to scroll up and down on the LCD screen. Allows you to scroll through menus, highlight items, and display speed dials list if you press down when the phone is on-hook. Display phone numbers from your Placed Calls if you press up when the phone is on-hook.
8	Line buttons 	Depending on configuration, programmable buttons provide access to: <ul style="list-style-type: none"> • Phone lines and intercom lines (line buttons) • Speed-dial numbers (speed-dial buttons, including the BLF speed-dial features) • Call features (for example, a Privacy button) Buttons light to indicate status: <ul style="list-style-type: none"> • Green, steady: Active call, answering call or two-way intercom call • Green, flashing: Held call • Amber, steady: Privacy in use, one-way intercom call, or DND active • Amber, flashing: Incoming call or reverting call • Red, steady: Remote line in use or parked • Red, flashing: Remote line on hold
9	Headset button 	Toggles headset on and off. When the headset is on, the button is lit.
10	Speaker button 	Toggles speaker on and off. When the speakerphone is on, the button is lit.
11	Dial pad	Functions as traditional telephone keypad.
12	Mute button 	Toggles mute on and off.

	Name	Description
13	Volume button 	Increases or decreases handset, headset, ringer, or speakerphone volume.
14	Messages button 	Provides access to message (voice mail) system.
15	Application button 	Provides access to phone settings such as call history, user preferences, phone configuration (including administration settings, device configuration, network configuration, and other common configurations), and phone model information.
16	Contacts button 	Provides access to phone directories.
17	Handset	Phone handset.

Physical Description of Cisco Unified IP Phone 6941



	Name	Description
1	Handset with indicator light	Functions as traditional handset and indicates an incoming call (flashing red) or new voice message (steady red).
2	LCD screen	Displays information such as incoming/outgoing call status, directories, line status, phone configuration options, and soft key tabs. Also, shows dedicated phone line labels.
3	Line buttons 	Depending on configuration, programmable buttons provide access to: <ul style="list-style-type: none"> • Phone lines and intercom lines (line buttons) • Speed-dial numbers (speed-dial buttons, including the BLF speed-dial features) • Call features (for example, a Privacy button) Buttons light to indicate status: <ul style="list-style-type: none"> • Green, steady: Active call, answering call or two-way intercom call • Green, flashing: Held call • Amber, steady: Privacy in use, one-way intercom call, or DND active • Amber, flashing: Incoming call or reverting call • Red, steady: Remote line in use or parked • Red, flashing: Remote line on hold
4	Soft key buttons 	Depending on how your system administrator sets up the phone, enable soft key options displayed on your phone screen.
5	Transfer button 	Transfers active calls to another extension.
6	Conference button 	Initiates the conference call.
7	Hold button 	Places the call on hold.

	Name	Description
8	Navigation Bar and Select (center) button 	The navigation bar allows you to scroll up and down on the LCD screen. Allows you to scroll through menus, highlight items, and display speed dials list if you press down when the phone is on-hook. Display phone numbers from your Placed Calls if you press up when the phone is on-hook.
9	Headset button 	Toggles headset on and off. When the headset is on, the button is lit.
10	Speaker button 	Toggles speaker on and off. When the speakerphone is on, the button is lit.
11	Dial pad	Functions as traditional telephone keypad.
12	Mute button 	Toggles mute on and off.
13	Volume button 	Increases or decreases handset, headset, ringer, or speakerphone volume.
14	Messages button 	Provides access to message (voice mail) system.
15	Application button 	Provides access to phone settings such as call history, user preferences, phone configuration (including administration settings, device configuration, network configuration, and other common configurations), and phone model information.
16	Contacts button 	Provides access to phone directories.
17	Handset	Phone handset.

Phone Screen

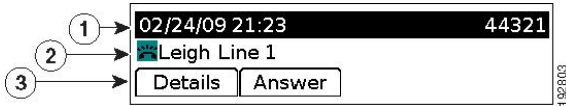

1	Header	Displays date, time, and directory number.
2	Line details and other phone information	Displays details for the active line during a call. If not on a call, displays line text label and other information such as placed calls, speed dials, and phone menu listings.
3	Soft key labels	Displays soft keys for available features or actions.

Phone Connections

This section shows and describes the connectors on your Cisco Unified IP Phones 6921 and 6941.

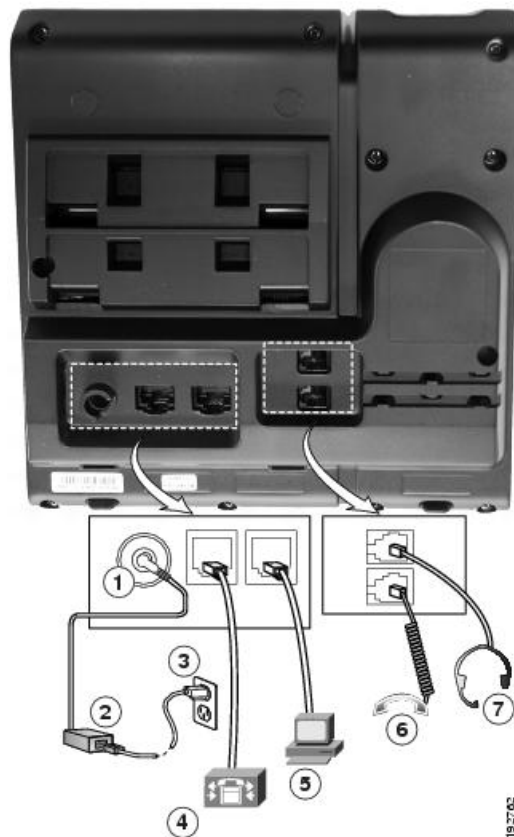

1	DC adapter port (DC48V) for phones not provided with inline power
---	---

2	AC-to-DC power supply
3	AC power cord
4	Network port (10/100 SW) for connecting to the network
5	Access port (10/100 PC) for connecting your phone to your computer
6	Handset port
7	Analog headset port

Footstand

If your phone is placed on a table or desk, the footstand can be connected to the back of the phone for a higher or lower viewing angle, depending on your preference.

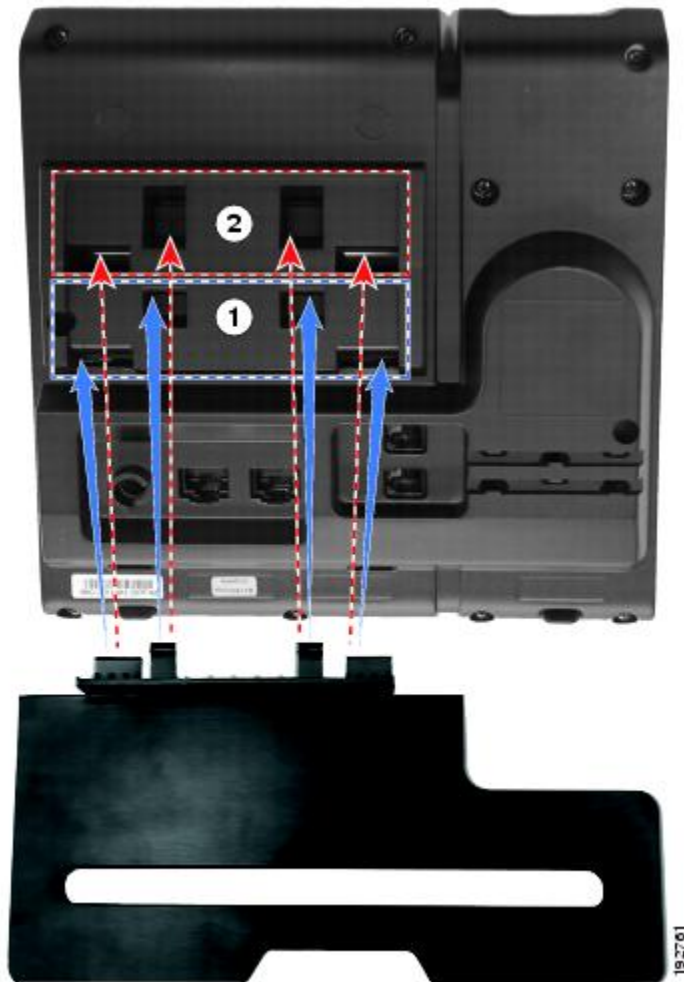

1	Footstand slots for a higher viewing angle	2	Footstand slots for a lower viewing angle
---	--	---	---

Adjusting the Handset Rest

You can adjust the handset rest of a wall-mounted phone so that the receiver does not slip out of the cradle.

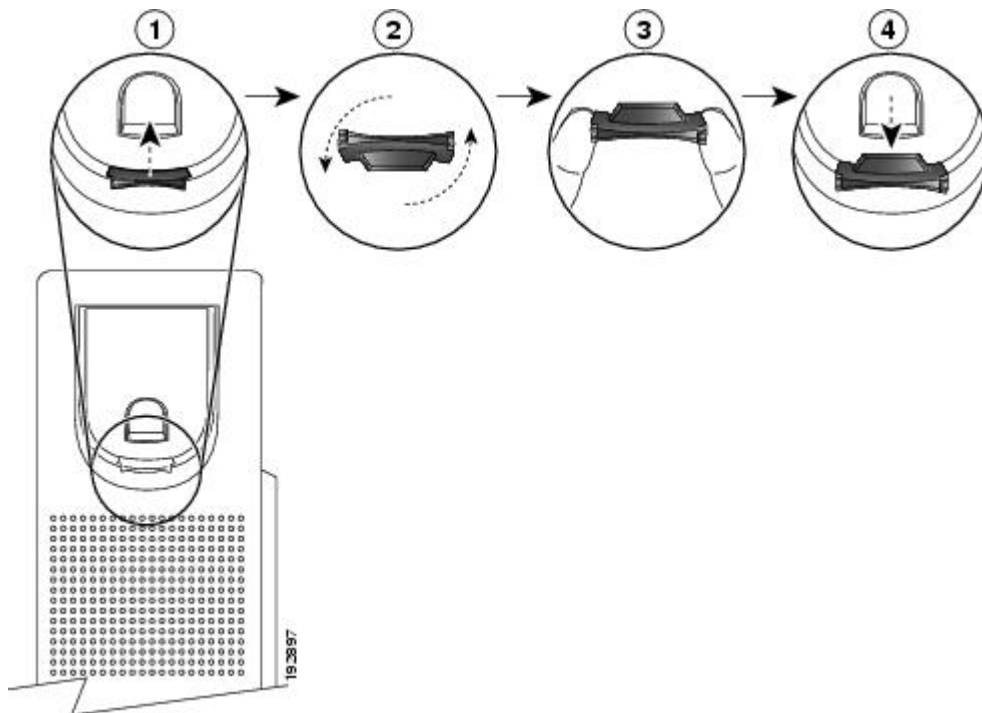







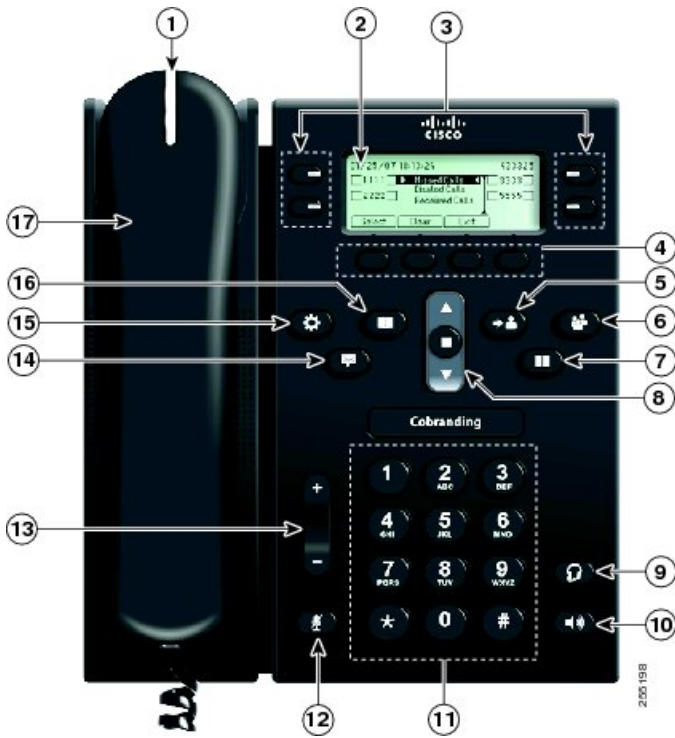

Procedure





-
- Step 1** Set the handset aside and pull the square plastic tab from the handset rest.
 - Step 2** Rotate the tab halfway (180 degrees).
 - Step 3** Hold the tab between two fingers, with the small notches (in the corners) facing you.
 - Step 4** Make sure the tab lines up evenly with the slot in the cradle.
 - Step 5** Slide the tab back into the handset rest. An extension protrudes from the top of the rotated tab. Return the handset to the handset rest.
-

Physical Description of Cisco Unified IP Phone 6945



	Name	Description
1	Handset with indicator light	Functions as traditional handset and indicates an incoming call (flashing red) or new voice message (steady red).
2	LCD screen	Displays information such as incoming/outgoing call status, directories, line status, phone configuration options, and soft key tabs. Also, shows dedicated phone line labels.

	Name	Description
3	Line buttons 	Depending on configuration, programmable buttons provide access to: <ul style="list-style-type: none"> • Phone lines and intercom lines (line buttons) • Speed-dial numbers (speed-dial buttons, including the BLF speed-dial features) • Call features (for example, a Privacy button) Buttons light to indicate status: <ul style="list-style-type: none"> • Green, steady: Active call, answering call or two-way intercom call • Green, flashing: Held call • Amber, steady: Privacy in use, one-way intercom call, or DND active • Amber, flashing: Incoming call or reverting call • Red, steady: Remote line in use or parked • Red, flashing: Remote line on hold
4	Soft key buttons 	Depending on how your system administrator sets up the phone, enable soft key options displayed on your phone screen.
5	Transfer button 	Transfers active calls to another extension.
6	Conference button 	Initiates a conference call.
7	Hold button 	Places the call on hold.
8	Navigation Pad and Select (center) button 	The navigation pad allows you to scroll up and down on the LCD screen. Allows you to scroll through menus, highlight items, and display speed dials list if you press down when the phone is on-hook. Display phone numbers from your Placed Calls if you press up when the phone is on-hook.
9	Headset button 	Toggles headset on and off. When the headset is on, the button is lit.
10	Speaker button 	Toggles speaker on and off. When the speakerphone is on, the button is lit.

	Name	Description
11	Dial pad	Functions as traditional telephone keypad.
12	Mute button 	Toggles mute on and off.
13	Volume button 	Increases or decreases handset, headset, ringer, or speakerphone volume.
14	Messages button 	Provides access to message (voice mail) system.
15	Application button 	Provides access to phone settings such as call history, user preferences, phone configuration (including administration settings, device configuration, network configuration, and other common configurations), and phone model information.
16	Contacts button 	Provides access to phone directories.
17	Handset	Phone handset.

Phone Screen

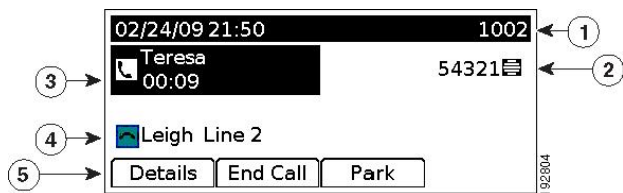

1	Header	Displays date, time, and directory number.
2	Line text label with icon	Displays text label and icon for phone or intercom line, speed-dial numbers, or services, depending on your configuration.
3	Primary line details and other phone information	During a call, displays details for the primary line. If not on a call, displays line text label and other information such as placed calls, speed dials, and phone menu listings.

4	Secondary line details and other phone information	Displays line label and call details for the secondary line and other phone information such as placed calls, speed dials, and phone menu listings.
5	Soft key labels	Displays soft keys for available features or actions.

Phone Connections

This section shows and describes the connectors on your Cisco Unified IP Phone 6945.

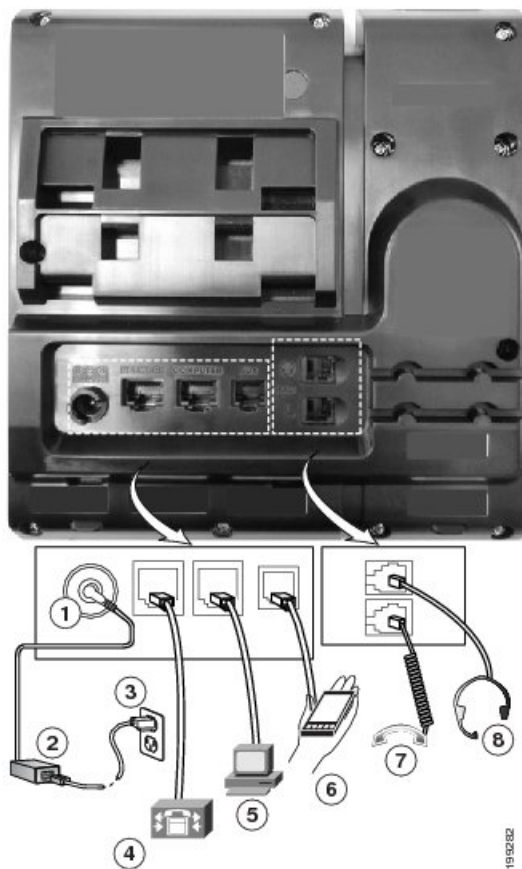

1	DC adapter port (DC48V) for phones not provided with inline power	5	Access port (10/100/1000 PC) for connecting your phone to your computer
2	AC-to-DC power supply (optional)	6	Auxiliary port
3	AC power cord (optional)	7	Handset connection
4	Network port (10/100 SW) for connecting to the network	8	Analog headset connection (optional)

Footstand

If your phone is placed on a table or desk, the footstand can be connected to the back of the phone for a higher or lower viewing angle, depending on your preference.



1	Footstand slots for a higher viewing angle	2	Footstand slots for a lower viewing angle
---	--	---	---

Higher Viewing Angle



Lower Viewing Angle



Adjusting the Handset Rest

You can adjust the handset rest of a wall-mounted phone so that the receiver does not slip out of the cradle.

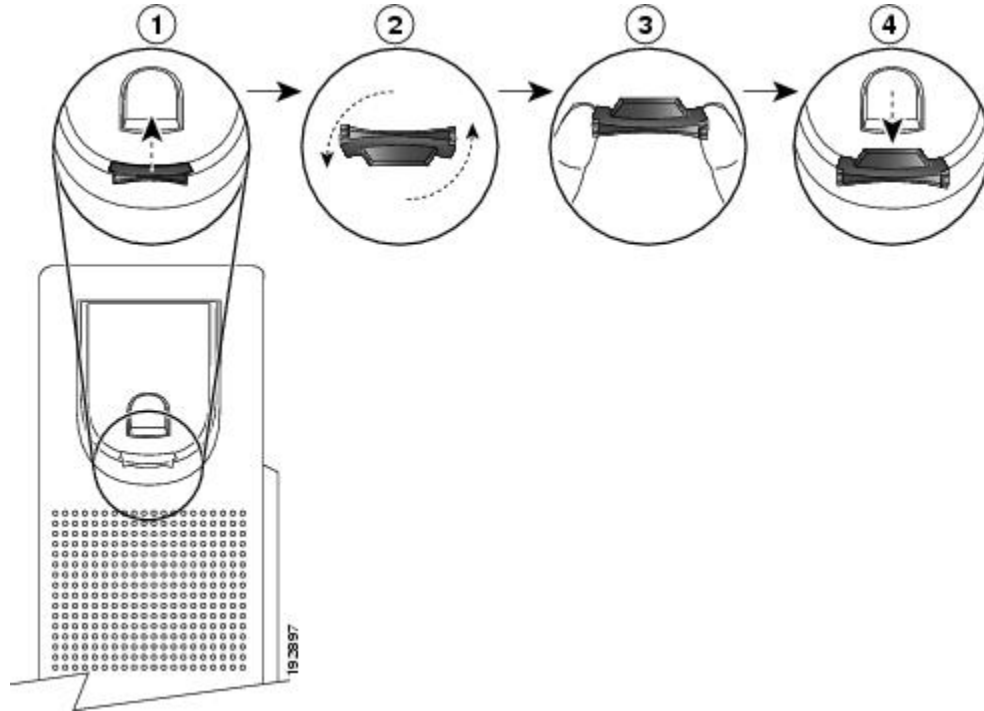







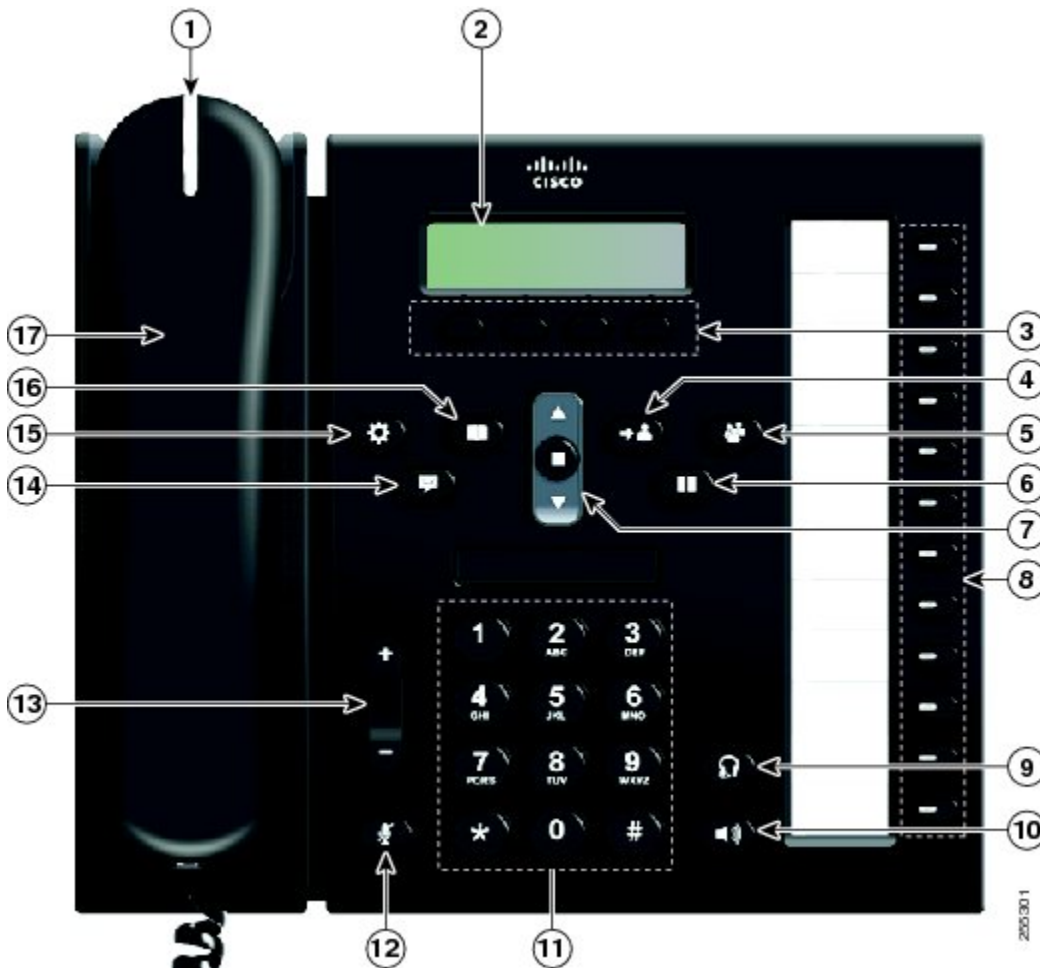

Procedure





- Step 1** Set the handset aside and pull the square plastic tab from the handset rest.
- Step 2** Rotate the tab halfway (180 degrees).
- Step 3** Hold the tab between two fingers, with the small notches (in the corners) facing you.
- Step 4** Make sure the tab lines up evenly with the slot in the cradle.
- Step 5** Slide the tab back into the handset rest. An extension protrudes from the top of the rotated tab. Return the handset to the handset rest.

Physical Description of Cisco Unified IP Phone 6961



	Name	Description
1	Handset with indicator light	Functions as traditional handset and indicates an incoming call (flashing red) or new voice message (steady red).
2	LCD screen	Displays information such as incoming/outgoing call status, directories, line status, phone configuration options, and soft key tabs. Also, shows dedicated phone line labels.
3	Soft key buttons	Depending on how your system administrator sets up the phone, enable soft key options displayed on your phone screen.

	Name	Description
4	Transfer button 	Transfers active calls to another extension.
5	Conference button 	Initiates the conference call.
6	Hold button 	Places the call on hold.
7	Navigation Bar and Select (center) button 	The navigation bar allows you to scroll up and down on the LCD screen. Allows you to scroll through menus, highlight items, and display speed dials list if you press down when the phone is on-hook. Display phone numbers from your Placed Calls if you press up when the phone is on-hook.
8	Line button 	Depending on configuration, programmable buttons provide access to: <ul style="list-style-type: none"> • Phone lines and intercom lines (line buttons) • Speed-dial numbers (speed-dial buttons, including the BLF speed-dial features) • Call features (for example, a Privacy button) Buttons light to indicate status: <ul style="list-style-type: none"> • Green, steady: Active call, answering call or two-way intercom call • Green, flashing: Held call • Amber, steady: Privacy in use, one-way intercom call, or DND active • Amber, flashing: Incoming call or reverting call • Red, steady: Remote line in use or parked • Red, flashing: Remote line on hold
9	Headset button 	Toggles headset on and off. When the headset is on, the button is lit.
10	Speaker button 	Toggles speaker on and off. When the speakerphone is on, the button is lit.
11	Dial pad	Functions as traditional telephone keypad.
12	Mute button 	Toggles mute on and off.

	Name	Description
13	Volume button 	Increases or decreases handset, headset, ringer, or speakerphone volume.
14	Messages button 	Provides access to message (voice mail) system.
15	Application button 	Provides access to phone settings such as call history, user preferences, phone configuration (including administration settings, device configuration, network configuration, and other common configurations), and phone model information.
16	Contacts button 	Provides access to phone directories.
17	Handset	Phone handset.

Phone Screen

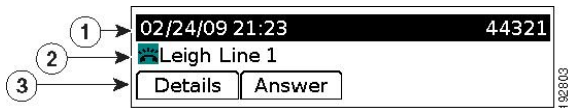

1	Header	Displays date, time, and directory number.
2	Line details and other phone information	Displays details for the active line during a call. If not on a call, displays line text label and other information such as placed calls, speed dials, and phone menu listings.
3	Soft key labels	Displays soft keys for available features or actions.

Phone Connections

This section shows and describes the connectors on your Cisco Unified IP Phone 6961.

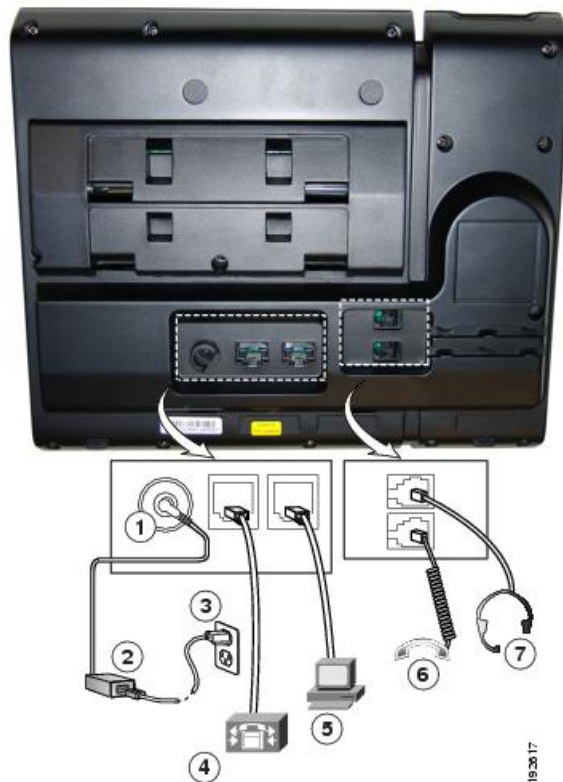

1	DC adapter port (DC48V) for phones not provided with inline power
2	AC-to-DC power supply
3	AC power cord
4	Network port (10/100 SW) for connecting to the network
5	Access port (10/100 PC) for connecting your phone to your computer
6	Handset port
7	Analog headset port

Footstand

The Cisco Unified IP Phone 6901 and 6961 has a foldable footstand. When the footstand is unfolded, it gives the phone an elevated viewing angle.



Adjusting the Handset Rest

You can adjust the handset rest of a wall-mounted phone so that the receiver does not slip out of the cradle.

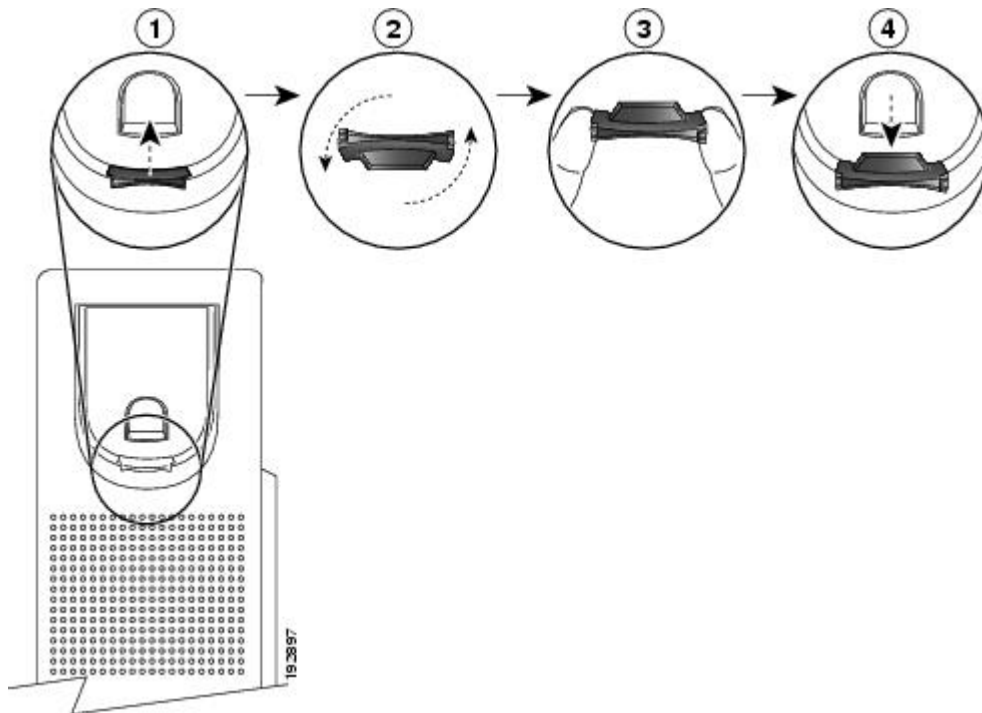

Procedure

- Step 1** Set the handset aside and pull the square plastic tab from the handset rest.
 - Step 2** Rotate the tab halfway (180 degrees).
 - Step 3** Hold the tab between two fingers, with the small notches (in the corners) facing you.
 - Step 4** Make sure the tab lines up evenly with the slot in the cradle.
 - Step 5** Slide the tab back into the handset rest. An extension protrudes from the top of the rotated tab. Return the handset to the handset rest.
-



CHAPTER 2

Operating Your Phone

This section describes how to operate your Cisco IP Phone and includes information on soft keys and phone features.

**Note**

In the Cisco Unified Communications Manager Express mode, Cisco IP Phone models 6921, 6941 and 6945 only supports one call per button. It is recommended to configure the dn as dual-line dn and the huntstop channel under the dn. The second channel on the dn can only be used for call transfer or conference.

**Note**

Because there are differences in phone and site configurations, not all features described here might apply to your phone. Consult your system administrator for more information.

- [Soft Key Descriptions](#), page 26
- [Access Services](#), page 28
- [Ad-hoc Conference](#), page 28
- [Adjust the Display Contrast](#) , page 29
- [Adjust the Ring Volume](#), page 29
- [Answer a Call](#), page 30
- [cBarge](#), page 30
- [Call History](#), page 30
- [Call Forward All](#), page 33
- [Call Park](#), page 34
- [Call Pickup](#), page 36
- [End a Call](#), page 37
- [Extension Mobility](#), page 37
- [Establish/End a Conference Call](#), page 38

- [Forward All Calls, page 39](#)
- [Hold/Resume a Call, page 39](#)
- [Intercom, page 39](#)
- [Manage Call Waiting, page 40](#)
- [Mobility, page 40](#)
- [Mute a Call, page 41](#)
- [My Phone Apps, page 41](#)
- [Phone Applications, page 42](#)
- [Phone Directory, page 42](#)
- [Place a Call, page 43](#)
- [Place a MeetMe Conference Call, page 44](#)
- [Privacy, page 44](#)
- [Redial a Number, page 44](#)
- [Select the Ringtone, page 44](#)
- [Shared Lines, page 45](#)
- [Sign In and Out of a Hunt Group , page 46](#)
- [Speed Dial, page 46](#)
- [Transfer a Call, page 47](#)
- [View Phone Information, page 48](#)
- [Voice Messages, page 48](#)

Soft Key Descriptions

Your Cisco IP Phone is equipped with soft keys for call features and options. Soft keys are displayed along the bottom of the LCD screen and activated using the corresponding buttons. Soft keys can change according to the state of the phone.



Note

Soft key availability depends on the system configuration and this is not the complete list of the soft keys.

Soft Key	Function
All calls	Lists all calls.
Answer	Answers an incoming call.
Backspace - <<X	Navigates to edit characters. Use the backspace soft key to erase digits that you entered incorrectly.

Soft Key	Function
Cfwdall	Forwards calls on your phone to another number.
Cancel	Cancel the last selection.
Clear	Clears directory history.
Call History	Provides call history.
Conf	Connects callers to a conference call.
Confrn	Initiates an ad-hoc conference.
Conflist	Lists current participants in the call.
Details	Provides caller id details.
Delete	Deletes the selected number.
Dial	Dials the displayed number.
EditDial	Selects a number and activates the cursor for editing.
EndCall	Ends the current call.
Exit	Exits from the current selection.
Fwd all	Forwards all calls.
Fwd Off	Sets call forwarding off.
Gpickup	Answers a call on a phone that is outside your call pickup group.
Hold	Places an active call on hold. Resumes call on hold.
Ignore	Returns to main screen.
Meetme	Initiates a Meetme conference.
Missed	Lists all the missed calls.
More	Scrolls through additional soft key options (for example, use the More soft key to locate the DnD soft key).
New Call	Opens a new line on the speakerphone to place a call.
Ok	Confirms the selection.
Park	Forwards calls to a location from which calls can be retrieved by anyone in the system.

Soft Key	Function
Pickup	Answers a call that is ringing on another phone within your call pickup group.
Redial	Redials last number dialed.
Remove	Removes last participant in a Meetme conference call.
RmLstC	Drops the last added participant in a ad-hoc conference.
Resume	Returns to active call.
Search	Initiates a search in local directory.
Transfer	Transfers the active call.
Update	Refreshes or updates the list.

Access Services

Procedure

- Step 1** Press the **Applications** button .
 - Step 2** Select **Services**. (Use the Navigation bar and button to scroll and select.)
 - Step 3** Highlight the service you want to access.
 - Step 4** Press the **Select** soft key, or press the **Exit** soft key to return to the Applications screen.
-

Ad-hoc Conference

An Ad-hoc conference is unscheduled and it happens when the conference creator adds a third party into the call.

Procedure

- Step 1** Press the **Conference** button  to place caller A on hold.
- Step 2** Place the call to caller B.
- Step 3** Press the **Conference** button again to connect all three parties to the conference bridge. The phone display will show “Conference” as the remote party ID.
The conference creator or participant can repeat the consultation and add more parties into the call.

There are three types of Ad-hoc conference:

- 1 Consultative conference—The conference creator commits after consultative party has been connected.
- 2 Early conference—The conference creator commits while consultative party is ringing.
- 3 Connected conference—The conference creator joins two pre-existing active calls.

If there are only two parties remaining in an ad-hoc conference, and if the conference is configured to stay, it will fall back to a point-to-point call and the conference bridge resource will be released.

**Note**

Consultative conference is the only one supported in this release.

Adjust the Display Contrast

The default contrast level setting is 50%.

Procedure

- Step 1** Press the **Applications** button .
 - Step 2** Select **Preferences**. (Use the Navigation bar and button to scroll and select.)
 - Step 3** Select **Contrast**.
 - Step 4** To increase contrast, press the up arrow on the Navigation button. To decrease contrast, press the down arrow.
 - Step 5** Press the **Save** soft key to set the contrast level, or press the **Cancel** soft key to exit.
-

Adjust the Ring Volume

- During a call, press the + or - on the **VOLUME** button to respectively increase or decrease the volume.
- Press the + or - on the **VOLUME** button while the handset is in its cradle and the phone is idle.

Answer a Call

Procedure



- Step 1** Lift the handset.
 - Step 2** If you are using a headset, press the **Headset** button.
 - Step 3** If you are using the speakerphone, press the **Answer** soft key or the **Speaker** button.
 - Step 4** If necessary, press the **line** button to select between incoming calls.
-

Auto Answer

Auto Answer prompts your phone to automatically answer incoming calls after one ring.

Your system administrator sets up Auto Answer to work either with your speakerphone or headset.

Procedure

- Step 1** Keep the headset  button illuminated when the phone is idle. Otherwise, calls ring normally and you must manually answer them.
 - Step 2** To keep the headset button illuminated, use a line button or soft keys (instead of the headset button) to go off-hook and on-hook and to place and end calls.
 - Step 3** Keep the handset in the cradle and the headset  button unlit. Otherwise, calls ring normally and you must manually answer them.
-

cBarge

The cBarge feature allows you to create a standard (ad hoc) conference by adding yourself to a call on a shared line.

Call History

This feature allows you to view call history information on your phone.



Clear Call History

Procedure

- Step 1** Press the **Applications** button .
 - Step 2** Select **Call History**. (Use the Navigation bar and button to scroll and select.)
 - Step 3** Select **All Lines** or the line that you want to view.
 - Step 4** Press the **Clear** soft key. (You may need to press the **More** soft key first.)
 - Step 5** Press the **Delete** soft key to delete the Call History screen or press the **Cancel** soft key to go back to the Call History screen.
-

Edit Number From Call History

Procedure

- Step 1** Press the **Applications** button .
 - Step 2** Select **Call History**. (Use the Navigation bar and button to scroll and select.)
 - Step 3** Select **All Lines** or the line that you want to view.
 - Step 4** Highlight the call you want to edit.
 - Step 5** Press the **EditDial** soft key. (You may need to press the **More** soft key first.)
 - Step 6** Press the **Forward Arrow** soft key to move the cursor to the right and press the **Backward Arrow** soft key to move the cursor to the left.
 - Step 7** Press the **Back Delete soft key**  to delete numbers.
 - Step 8** Press the **Dial** soft key to dial the edited number.
 - Step 9** Press the **Back** soft key  to return to the Call History screen.
-

Delete a Call Record From Call History

Procedure

- Step 1** Press the **Applications** button .
- Step 2** Select **Call History**. (Use the Navigation bar and button to scroll and select.)
- Step 3** Select **All Lines** or the line that you want to view.
- Step 4** Highlight the call you want to delete.
- Step 5** Press the **Del Call** soft key. (You may need to press the **More** soft key first.)
- Step 6** Press the **Delete** soft key to delete the call or press the **Cancel** soft key to go back to the Call History screen.
-

Filter Call History

Procedure

- Step 1** Press the **Applications** button .
- Step 2** Select **Call History**. (Use the Navigation bar and button to scroll and select.)
- Step 3** To sort calls for a specific phone line, select **All Lines** or the line that you want to view.
- Step 4** To sort by missed calls for the selected line, select the **Missed** soft key.
The Call History screen displays only the missed calls on the selected line.
- Step 5** To view all calls in the Call History screen, press the **All Calls** soft key.
- Step 6** Press the **Exit** soft key to return to the Call History screen.
-

Place a Call from Call History

Procedure

- Step 1** Press the **Applications** button .
- Step 2** Select **Call History**. (Use the Navigation bar and button to scroll and select.)
- Step 3** Select **All Lines** or the line that you want to view.
- Step 4** From the Call History screen, highlight the call you want to dial and perform one of the following:
- Press the **New Call** soft key.
 - Press the **line** key.
 - Pick up the handset.

- Press the **Speaker** or **Headset** button.
-



View Call History

Procedure

- Step 1** Press the **Applications** button .
 - Step 2** Select **Call History**. (Use the Navigation bar and button to scroll and select.)
 - Step 3** Select **All Lines** or the line that you want to view.
 - Step 4** Press the **Exit** soft key to return to the Call History screen.
-

View Call Record Details

Procedure

- Step 1** Press the **Applications** button .
 - Step 2** Select **Call History**. (Use the Navigation bar and button to scroll and select.)
 - Step 3** Select **All Lines** or the line that you want to view.
 - Step 4** Select a call record.
 - Step 5** Press the **Details** soft key. (You may need to press the **More** soft key first.)
 - Step 6** Press the **Back** soft key  to return to the Call History screen.
-

Call Forward All

Call Forward All allows you to forward calls on your phone to another number.

For your primary line, you can set up Call Forward All directly on your phone. For all other lines—or to access Call Forward All remotely—go to your User Options web pages.

There are two types of call forwarding features that your system administrator might set up on your phone:

- 1 Unconditional call forwarding (Call Forward All)—Applies to all calls that you receive.
- 2 Conditional call forwarding (Call Forward No Answer, Call Forward Busy, Call Forward No Coverage)—Applies to certain calls that you receive, according to conditions, and is accessible only from your User Options web pages.

When forwarding calls from your phone:

- Enter the call forward target number exactly as you would dial it from your phone. For example, enter an access code or the area code, if necessary.
- Call forwarding is phone-line specific. If a call reaches you on a line where call forwarding is not enabled, the call will ring as usual.
- Your system administrator can set up other call forward options that:
 - Allow calls placed from the call forward target number to your phone to ring through, rather than be forwarded.
 - Prevent you from creating a call forward loop or exceeding the maximum number of links in a call forwarding chain.

Call Park

Call Park allows you to park (temporarily store) a call you receive on your phone, which you can then retrieve from another phone (for example, a phone at a co-worker's desk or in a conference room).

There are two ways you can park a call:

- 1 Park—Allows you to park an active call that you answered on your phone, and retrieve it using another phone in the Cisco Unified Communications Manager Express system.
- 2 Directed Call Park—Allows you to park and retrieve an active call in two different ways:
 - a Assisted Directed Call Park—Allows you to park an active call by pressing a line button, which your system administrator sets up as a speed dial line.

With this type of directed call, you can monitor the status of the line (in-use, idle, or in Do Not Disturb state) using Line Status indicators.
 - b Manual Directed Call Park—Allows you to park an active call by transferring it to a Directed Call number, which your system administrator sets up.

You retrieve the call at another phone by dialing a park retrieval prefix number (provided by your system administrator), then dialing the Directed Call number you used to park the call.

Your system administrator sets up either the Directed Call Park or Park feature on your phone, but not both.

Park and Retrieve a Call Using Call Park

Call park allows you to place a call on hold at a designated parking slot from which the call can be retrieved by anyone on the system.



Note

Contact your system administrator for your call park slot number.



Procedure

- Step 1** During a call, press the **Park** soft key, then hang up.
For the duration of the call, your phone displays the call park number where the system stored the call.
- Step 2** Retrieve the call from any other Cisco Unified IP Phone in your network by entering the call park number.
If you do not retrieve the call within a certain amount of time (set by your system administrator), a reminder tone will sound on your phone, at which time you can resume the call by pressing the **Resume** soft key or by retrieving it from another phone.
- If you do not retrieve or resume the call within a specified amount of time (set by your system administrator) after the reminder tone, the call will be directed to another destination (set up by your system administrator), such as voicemail.
-

Park and Retrieve a Call using Assisted Direct Call Park

This feature is supported only in Cisco Unified IP Phone 6941, 6945, and 6961.

Procedure

- Step 1** During a call, press the **Transfer** button .
- Step 2** Press the **Directed Call Park** line button.
- Step 3** Press the **Transfer** button .
- You have a limited time to retrieve the parked call before it reverts to ringing at the original number.
- Step 4** Retrieve the call as follows:
- Dial the retrieval park-slot extension.
 - Dial the Directed Call number.

Example:

If the park retrieval prefix is "77" and the Directed Call number is "6789", enter 776789.

Park and Retrieve a Call Using Manual Directed Call Park

Procedure

- Step 1** During a call, press the **Transfer** button .
- Step 2** Enter the Directed Call number where you will park the call.
- Step 3** Press **Transfer** to finish parking the call, then hang up.
You have a limited time to retrieve a parked call before it reverts to ringing at the original number.
- Step 4** Retrieve the call from any other Cisco Unified IP Phone in your network as follows:
- Dial the retrieval park-slot extension.
 - Dial the Directed Call number.

Example:

If the park retrieval prefix is "77" and the Directed Call number is "6789", enter 776789.

Call Pickup

Call Pickup allows you to answer a call that is ringing on a co-worker's phone by redirecting the call to your phone.

There are two ways you can pick up a call:

- 1 **Pickup**—Allows you to answer a call that is ringing on another phone within your call pickup group.
If multiple calls are available for pick up, your phone picks up the oldest call first (the call that has been ringing for the longest time).
- 2 **Group Pickup**—Allows you to answer a call on a phone that is outside your call pickup group by:
 - Using a group pickup number (provided by your system administrator)
 - Dialing the ringing phone's number.
- 3 **Other Pickup**—Allows you to answer a call that is ringing on another phone within in your call pickup group or in an associated call pickup group.



Note

Your system administrator sets up the call pickup group you are in and the Pickup soft keys depending on your call-handling needs and work environment.

Your system administrator may also change the function of the Pickup key to operate as Directed Pickup of a specific extension instead of local group pickup. In this configuration, the calls from you local group can be picked up by pressing the **GPickUp** key followed by the **Star** key.

Answer a Call Using Pickup

Procedure

- Step 1** Press the **PickUp** soft key to transfer a ringing call within your pickup group to your phone.
- Step 2** Perform the following steps if you have multiple lines and want to pick up the call on a non-primary line.
- a) Press the desired line button.
 - b) Press **PickUp**.
If your phone supports auto-pickup, you are connected to the call.
If the call rings, press the **Answer** soft key to connect to the call.
-

End a Call

- Hang up the handset.
- If you are using a headset, press the **Headset** button or the **EndCall** soft key.
- If you are using a speakerphone, press the **Speaker** button or the **EndCall** soft key.

Extension Mobility

Cisco Extension Mobility (EM) allows you to temporarily configure a Cisco Unified IP Phone as your own. After you sign in to EM, the phone adopts your user profile, including your phone lines, features, established services, and web-based settings. Your system administrator sets up EM for you.

Enable Extension Mobility

Procedure

- Step 1** Press the **Applications** button .
 - Step 2** Select **My Phone App**. (Use the Navigation bar and button to scroll and select.)
 - Step 3** Select **EM Service** (name will vary).
 - Step 4** Enter your user ID and PIN (provided by your system administrator).
 - Step 5** If prompted, select a device profile.
 - Step 6** To sign out, press the **Applications** button.
 - Step 7** Select **My Phone App**.
 - Step 8** Select **EM Service** (name will vary).
 - Step 9** When prompted to sign out, press the **Yes** soft key.
-

Establish/End a Conference Call

Your system administrator must configure the system for a three-party or eight-party ad-hoc conference.

Procedure

- Step 1** During a call, press the **Conference** button to open a new line and put the first party on hold.
 - Step 2** Place a call to another number.
 - Step 3** Press **Conference** button again to add the new party to the call.
 - Step 4** Perform any of the following steps to end a conference call:
 - Hang up the handset, or press the **Cancel** soft key.
 - Depending on the configuration, when the conference call initiator disconnects, the conference call terminates.
 - To end the conference and remain connected to the most recent call, press the **Conf** soft key. The older call is placed on hold.
-

Forward All Calls

Procedure

- Step 1** Press the **Fwd All** soft key.
You will hear a confirmation beep.
 - Step 2** Dial the number to which you want to forward all your calls. Dial the number exactly as if you were placing a call to that number. Remember to include locally required prefix numbers.
The phone display is updated to show that calls will be forwarded.
 - Step 3** To cancel call forwarding, press the **Fwd Off** soft key.
-

Hold/Resume a Call

Procedure

- Step 1** Press the **Hold** button.
- Step 2** Press the **Resume** soft key or the flashing green line button to resume the call.
- Step 3** If your phone supports multiple lines, you can use line buttons to swap between holding and active calls.

Example:

If you have a holding call on Line 1 and an active call on Line 2, pressing the **Line 1** button makes the Line 1 call active (resumes it from hold) and automatically puts the Line 2 call on hold.

Intercom

Intercom allows you to place and receive one-way calls using a dedicated intercom line.

When you place an intercom call, the recipient's phone auto-answers with mute activated (whisper) and broadcasts your message through the recipient's speakerphone—or through the headset or handset, if one of these devices is active.

After receiving the intercom call, the recipient can initiate two-way audio (connected) to continue the call.

Place an Intercom Call

Procedure

- Step 1** Press the **Intercom** button.
If your phone auto-dials the intercom code, begin speaking after the alert tone. Otherwise, go to Step 2.
- Step 2** Enter the intercom code and begin speaking after the alert tone.
-

Receive an Intercom Call

When you receive an intercom call, you hear an intercom-alert tone and your phone auto-answers the call. Any current call activity that you are engaged in continues simultaneously, but the intercom caller cannot hear you.

To speak to the intercom caller, press the active **Intercom** button.

Manage Call Waiting

If you are on a call when a second call comes in, you hear a call-waiting tone or see a flashing indicator light on the handset rest, depending on the configuration of your phone.

To answer the new call on the same line:

- 1 Press the **line** button to go to the other call.
- 2 Press the **Answer** soft key to answer the call. The call on the other line is automatically put on hold.

To return to the original call:

- 1 Press the **line** button to go to the other call.
- 2 Press the **Resume** soft key to reconnect to the call.

**Note**

Unanswered calls are routed to your voicemail system (if available).

Mobility

Mobility allows you to transfer a call from an IP Phone to your mobile phone.

**Note**

Contact your system administrator to enable/disable the mobility feature on your IP Phone.

Procedure

- Step 1** Select **Mobility** soft key while on an active call.
- Step 2** Select **Send call to mobile**.
The call will be transferred to your mobile phone.
-

Mute a Call

To mute a call:

- While on a call, press the **Mute** button . The Mute button lights, indicating that the other party cannot hear you.

To deactivate the mute function, do one of the following:

- 1 Press the **Mute** button again.
- 2 Lift the handset if you are using mute with your speaker phone.



Note The Mute feature does not generate music or a tone.

My Phone Apps

My Phone Apps provides an interface for users to do the following tasks right on the phone:

- Add, Delete, and Modify speed dials
- Add, Delete, and Modify fast dials
- Add, Delete, and Modify BLF speed dials
- Set SNR number

Procedure

- Step 1** Access Phone Services.
- Step 2** Select **My Phone Apps**.
- Step 3** Select a service from the My Phone Apps submenu and follow the instructions.
-

Phone Applications

Phone applications allow you to access the following:



- 1 Administrator Settings (for system administrators only)
- 2 Call History
- 3 Phone Information
- 4 Preferences
- 5 Services

Phone Directory

The Cisco Unified IP Phone 6900 series provide you with access to corporate and personal contacts.

Search for and Dial a Contact

Procedure

- Step 1** Press the **Contacts** button .
- Step 2** Press **1** to highlight **Personal Directory** or Press **2** to highlight **Corporate Directory**.
- Step 3** Press the **Select** button.
- Step 4** For Personal Directory, enter the User ID and PIN.
- Step 5** Press the **Submit** soft key or press **Cancel** to exit.
- Step 6** For Corporate Directory, use the **Navigation** bar to select any of the following criteria to search for a co-worker:
- First name
 - Last name
 - Number
- Step 7** Enter the required information.
- Step 8** Press the **Search** soft key.
- Step 9** Perform any of the following tasks:
- Press the **New Call** soft key.
 - Press the **Select** button on the **Navigation** bar.
 - Press a line button.
 - Press the **Speaker** button .
 - Press the **Headset** button .
 - Pick up the handset.



Search for and Dial a Contact while on a Call

Procedure

-
- Step 1** Press the **Contacts** button .
- Step 2** Press the **Personal Directory** or **Corporate Directory** soft key.
- Step 3** Press the **Select** button.
- Step 4** For Personal Directory, enter the User ID and PIN.
- Step 5** Press the **Submit** soft key or press **Cancel** to exit.
- Step 6** For Corporate Directory, select any of the following criteria to search for a co-worker:
- First name
 - Last name
 - Number
- Step 7** Enter the required information.
- Step 8** Select **Search > Dial**.
-

Place a Call

Use one of the following methods to place a call:

- Lift the handset and dial the number.
- Dial the number, and then lift the handset.
- Dial the number, and then press the **Dial** soft key.
- Dial the number, and then press the **Speaker** button.
- Press the **line** button for your extension, and then dial the number.
- Press the **Speaker** button , and then dial the number.
- Press the **New Call** soft key, and then dial the number.
- If you are using a headset, press the **Headset** button  , and then dial the number.
- Dial the number, and then press the **Headset** button .
- If you have established speed-dial numbers, press a **Speed-dial** button.
- If you have selected a number from a directory, press the **New Call** soft key.
- If you have selected a number from a directory, press the **Line / Headset / Speaker** button.

Place a MeetMe Conference Call

Procedure

- Step 1** Obtain a MeetMe conference number from your system administrator
- Step 2** Distribute the MeetMe conference number to all the participants.
- Step 3** Go off-hook.
- Step 4** Press the **MeetMe** soft key.
- Step 5** Dial the MeetMe conference number.
All other participants can join the meeting by dialing into the MeetMe conference number.
- Step 6** To end the MeetMe conference call, all participants must hang up the handset or press the **Cancel** soft key.
-

Privacy

Privacy allows you to prevent others who share your line from seeing information about your calls.

Privacy applies to all shared lines on your phone. If you have multiple shared lines and Privacy is enabled, others cannot view any of your shared lines.

Redial a Number

To redial the most recently dialed number:



- Lift the handset and press the **Redial** soft key.
- Press the **Redial** soft key to make a call using a speakerphone or headset.
- To place the call on a particular phone line, get a dial tone on that line, then press the **Redial** softkey.

Select the Ringtone



Note You can set separate ringtone for multiple lines by pressing the **Line** button. Also, you can set separate a ringtone for each number when there are multiple phone numbers on the phone.

Procedure

- Step 1** Press the **Applications** button .
 - Step 2** Select **Preferences**. (Use the Navigation bar and button to scroll and select.)
 - Step 3** Select **Ringtone**.
 - Step 4** If multiline is configured, select a line that you want to change the ringtone.
 - Step 5** Highlight a ringtone.
 - Step 6** Press the **Play** soft key to play a sample.
 - Step 7** Press the **Set** soft key to select the ringtone.
 - Step 8** Press the **Apply** soft key to confirm your selection, or press the **Cancel** soft key to go back to the Ringtone screen.
 - Step 9** Press the **Back** soft key  to return to the Preferences screen.
-

Shared Lines

Shared lines allow you to use one phone number for multiple phones.

You might have a shared line if you have multiple phones and want one phone number, share call-handling tasks with co-workers, or handle calls on behalf of a manager.

You or your co-worker can join a call on the shared line using the Barge feature. Barge converts the call into a conference. To barge, press the **red session** button for the remote in-use call on the shared line.

For example, if you share a line with a co-worker,

- When a call comes in on the shared line:
 - Your phone rings and the line button flashes amber.
 - Your co-worker's phone rings and the line button flashes amber and either you or your coworker can answer the call.
- When your co-worker has a call on the shared line:
 - The Shared Line button on your phone appears solid red to indicate that the line is in-use remotely.
 - Your co-worker's call displays on your screen (unless your co-worker has Privacy enabled).
- If you answer the call:
 - Your line button turns green.
 - Your co-worker's line button turns red.
When button is red, that line cannot be used to barge in on the call or used to make another call.
- If you put the call on hold:
 - Your line button flashes green
 - Your co-worker's line button flashes red.

- When the line flashes red, your co-worker can pick up the call.

Sign In and Out of a Hunt Group

Procedure

- Step 1** Press the **Hunt Group** line button to sign in. Visual confirmation displays briefly.
- Step 2** Press the button again to sign out. Signing out of a hunt group does not prevent non-hunt group calls from ringing your phone.
-

Speed Dial

Speed dialing allows you to enter an index number, press a button, or select a phone screen item to place a call. Depending on your setup, your phone can support the following speed-dial features:

- Speed-Dial Buttons—Allows you to quickly dial a phone number from one or more line buttons set up for speed dialing.
- Speed-Dial Codes—Allows you to dial a phone number from a code (sometimes referred to as abbreviated dialing).
- Fast Dials—Allows you to enter a Fast Dial code to place a call. Fast Dial codes can be assigned to phone numbers or Personal Address Book entries.

Set up Speed-Dial Buttons

Speed dial allows you to place a call by pressing a line button or selecting a phone display item.

Procedure

- Step 1** Sign in to your User Options Web pages.
- Step 2** Select **User Options > Device**.
- Step 3** Select a phone from the Name drop-down menu.
- Step 4** Click **Speed Dials**.
- Step 5** In the Speed Dial Settings area, enter a number and label for a speed-dial button (programmable button) on your phone.
- Step 6** Click **Save**.
-

Speed-Dial Button

To place a call when your phone is on-hook:

- Enter the pre-configured speed-dial code and press the **SpeedDial** soft key.

To place a call when your phone is off-hook:

Procedure

- Step 1** Press the **SpeedDial** soft key.
 - Step 2** Enter the pre-configured speed-dial code.
 - Step 3** Press the **SpeedDial** soft key.
-

Transfer a Call

You can use consultative transfer to transfer a selected call to another number.

Consultative Transfer

Redirects the call after first allowing you to speak to the transfer recipient.

Procedure

- Step 1** During a call, press the **Transfer** button . The call is placed on hold.
 - Step 2** Dial the number to which you want to transfer the call.
 - Step 3** Wait for the call to be answered.
 - Step 4** Press the **Transfer** button or hang up the handset.
 - Step 5** If the transfer fails, press the **Resume** soft key to return to the original call.
-

Cancel Transfer



Note

In the Cisco Unified Communications Manager Express mode, Cisco IP Phone models 6921, 6941, 6945, and 6961 only supports one call per button. It is recommended to configure the dn as dual-line dn and the huntstop channel under the dn. The second channel on the dn can only be used for call transfer or conference.

Procedure

Press the **Cancel** soft key.

View Phone Information

Procedure

-
- Step 1** Press the **Applications** button .
- Step 2** Select **Phone Information**. (Use the Navigation bar and button to scroll and select.)
- Step 3** Press the **Exit** soft key to return to the Applications screen.
-

Voice Messages

Voice messages are stored on your voicemail system. Your company determines the voicemail system your phone uses.

Check for Voice Messages



Note You can configure the visual message indicator lamp and audible message indicator using your User Options Web pages.

Procedure

-
- Step 1** Look at the visual message indicator lamp on your handset.
- Step 2** Look for the following:
- (For Cisco Unified IP Phone 6941 only.) A message waiting icon.
 - (For Cisco Unified IP Phone 6921 and 6941 only.) A text message.
- Step 3** Listen for a stutter tone from your handset, headset, or speakerphone when you place a call. The stutter tone is line-specific. You hear it only when using the line that has a waiting message.
-

Listen to Voice Messages

- Press the **Messages** button  to listen to voice messages left on any line.
- Press a **line** button, then press **Messages** to hear only the voice messages for that line.

Personalize Your Voicemail

Procedure

- Step 1** Press the **Messages** button .
- Step 2** Follow the voice prompts.
-

