

INSTALLATION & OWNER'S MANUAL

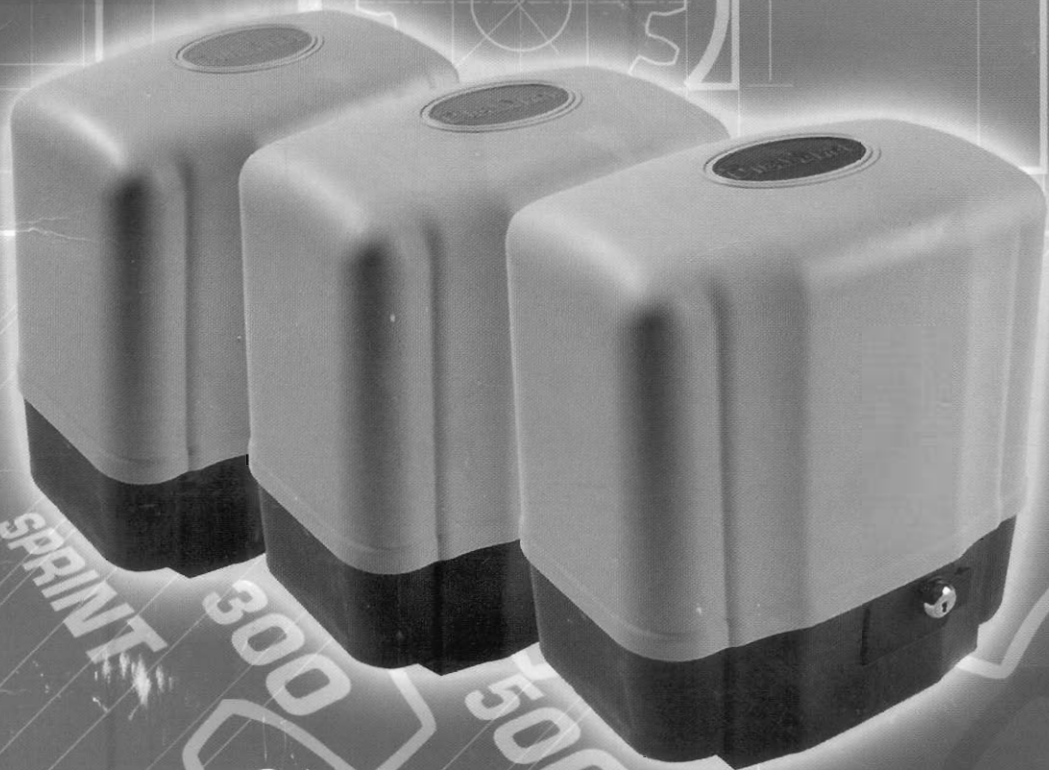

SPRINT 300 500

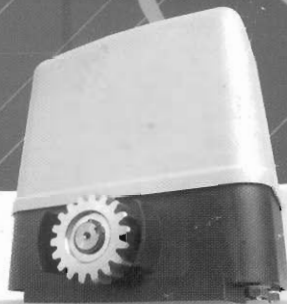

**AUTOMATIC GATE
OPERATOR**

Index



1. Legal Requirements
2. Recommended Tools
3. Terms and Definitions
4. Optional Extras
 - I. DuraOptics Infra Red Beams
 - II. DuraTronic Code Hopping Receiver
 - III. DuraTronic Remote Controls
 - IV. Anti Tamper switch connection
 - V. Pillar Light Interface
 - VI. Gate Status Indicator
 - VII. Pedestrian Pushbutton
 - VIII. Anti Theft Bracket
5. Site Evaluation
 - I. Lay of the land
 - II. Concrete / Brick work
 - III. Gate requirements
6. Motor Installation
 - I. Mounting the Foundation Plate
 - II. Removing Lid
 - III. Electrical Wiring
 - IV. Anchoring the Motor
 - V. Mounting the Rack
 - VI. Filling Gear Box Oil
 - VII. Mounting the Magnet
7. Commissioning the Motor
 - I. Checking Motor Direction
 - II. P.C. Board Layout
 - III. Programming Procedure
 - IV. Collision Sensing
 - V. Dipswitch Setup
 - VI. Party Mode
8. Connecting Auxiliary Equipment
 - I. Receiver
 - II. Intercom Pushbutton / Pedestrian Pushbutton
 - III. Infra Red Safety Beams
 - IV. Pillar Light Interface
 - V. Gate Status Indicator
 - VI. Lightning Suppression
9. Warranty
10. Technical Specifications
 - I. 300
 - II. 500
 - III. Sprint
11. Trouble Shooting

INTRODUCTION

Congratulations on purchasing your DURASLIDE gate motor. D.A.C.E has proven to be a leader in the automation field and strives to manufacture high quality products using the latest technology available.

D.A.C.E. is constantly working on upgrading their products to bring you, the customer, a product of the highest quality. Other products manufactured by D.A.C.E. include:

- DURASLIDE 300 SERIES / 500 SERIES / SPRINT SERIES
- DURASWING GATE MOTORS
- DURAOPTICS INFRARED BEAMS
- DURATRONIC REMOTES AND RECEIVERS

It is recommended that an experienced gate installer is used to install your gate motor. If you intend to install this motor yourself, please read this manual carefully before any installation begins. This automatic gate operator is NOT a security device. It is designed to make access to a premise undemanding.

Warning 220V/AC installation

1. LEGAL REQUIREMENTS AND WARNINGS

- It is recommended that your local E.C.A. (Electrical Contractors Association) is contacted in order to obtain the legal wiring regulations pertaining to the area.
- Electrical Shock may occur while installing this equipment.
- Injury or death by electrocution may lead to law suits against the installer/homeowner.
- If you intend to run 220V/AC directly from the Mains supply (house supply) to the transformer, the wiring should be done by a qualified/registered electrician. This is a legal requirement and failure to do so may lead to non compliance of property or law suits against the property owner in the event of an accident.
- It is a legal requirement to run all cabling in conduit. The power supply must be run in a separate conduit to the communication cables.
- Mains supply may only be run in a guarded cable. Under no circumstances may 220V/AC be run using Communication, Cabtyre or Ripcord Cables.
- D.A.C.E will not be held liable for any accident / incident resulting in damage, injury or death ensuing from the installation of the automatic gate motor.
- Although the DuraSlide has built-in collision sensing, substantial damage may occur. For this reason safety beams should be used on all installations.
- Do not allow children to play near or with any gate, gate motor or remote control.
- It is the responsibility of the installer to ensure that the gate is in good working condition before automating the gate.

2. RECOMMENDED TOOLS

- Assorted screw drivers – Phillips and flat
- 17mm spanner
- 17mm Socket
- Tape Measure
- Spade
- Pick
- Level
- Drilling Machine
- Steel Drill Bits
- Masonry Drill Bits
- Hammer
- Multi Meter
- Side Cutters
- Hacksaw

3. TERMS AND DEFINITIONS

- **AUTOCLOSE**- allows gate to close automatically after a selected time period (see Dipswitch setup)
- **PEDESTRIAN ACCESS**- gate will open partially and will autoclose after 6 secs.
- **PARTY MODE**- this allows autoclose to be overridden and gate can remain open for as long as needed.
- **MULTI USER**- commonly used in a town house situation. The gate will open completely, regardless of any other trigger received.(see dipswitch setup)
- **COLLISION SENSING**- in the event of a collision while closing, the gate will stop and then reopen. If collision occurs while opening , the gate will stop.
- **BATTERY**- 12 volt 7 amp/hour, drives the motor.
- **CHARGER MODULE**- delivers a trickle charge to maintain a constant 13,8 V/DC in the battery.
- **TRANSFORMER**- receives 220 V/AC from the mains supply and delivers 16 V/AC to the charger module.
- **MAIN P.C. BOARD**- this is the printed circuit board that contains all the electronic components that operate the motor. (Fig 11)
NOTE : always remove the power from the P.C. Board before connecting any inputs.
- **RECEIVER**- this is an external component that will trigger the motor via the main P.C. Board
- **REMOTE / TRANSMITTER**- this is a device that will trigger the motor via the receiver.
- **INTERCOM**- there are many types of intercoms available, an intercom allows communication between the gate and the house. There is normally a button on the intercom handset that operates the gate.
- **TEST BUTTON**- button found on the main P.C. Board that is used to activate the motor during programme mode.
- **RACK**- length of gear mounted on the gate. (Fig. 1.1)
- **PINION**- drive gear fitted to main drive shaft of motor.
- **FOUNDATION PLATE**- secures motor to concrete plinth. (Fig.1.2)
- **MANUAL OVERRIDE MODE**- allows the gate to be moved by hand.(Fig.6)

BASIC SITE LAYOUT

Fig. 1.1

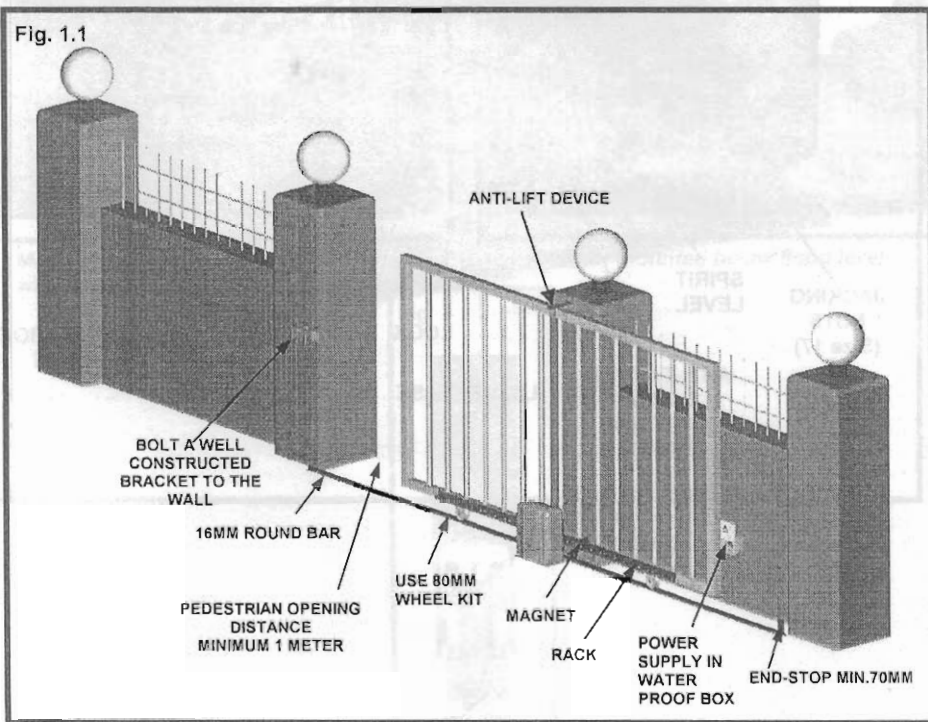
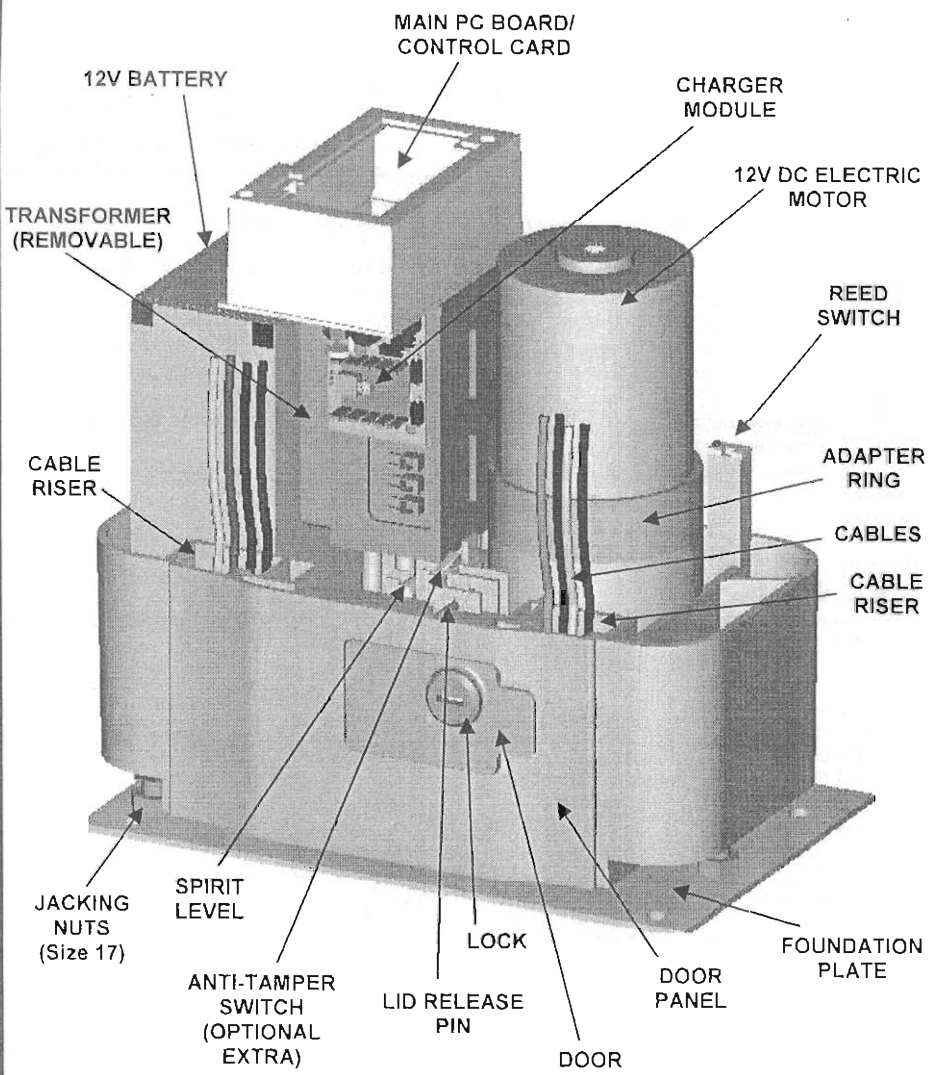

Fig. 1.2



4. OPTIONAL EXTRAS

I. DURAOPTIC INFRA RED BEAMS- it is strongly recommended that beams are used on all installations. The beams are designed to stop the gate from closing on a vehicle / pedestrian. If the gate is closing and the beam is broken, the gate will stop and then re-open.

II. DURATRONIC CODE HOPING RECEIVER- radio receiver which uses random code radio signals to activate the motor.

III. DURATRONIC REMOTE CONTROL- radio transmitter which transmits a secure radio signal to the receiver.

IV. ANTI TAMPER SWITCH- this is a microswitch which can be connected to a house alarm zone that will trigger the alarm if the motor cover is removed.

V. PILLAR LIGHT INTERFACE- automatically switches lights on when a trigger is received. The lights will stay on for 4 minutes.

VI. GATE STATUS INDICATOR- the position of the gate can be seen on a L.E.D. which can be fitted to the intercom handset.

VII. PEDESTRIAN PUSHBUTTON- activates the gate in pedestrian mode

VIII. ANTI THEFT BRACKET- deters theft of the motor

5. SITE EVALUATION.

I. LAY OF THE LAND- it is important that the rail is level and the motor is above the flood level. (Fig.2.1)

II. CONCRETE AND BRICK WORK- A concrete plinth of approximately 400 x 400 x 300 must be laid to secure the foundation plate (Fig.5.1).

Fig. 2.1

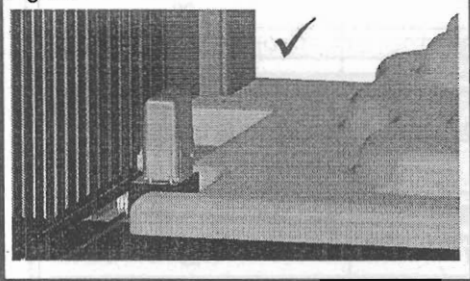

Motor mounted above flood level with adequate drainage.

Fig. 2.2

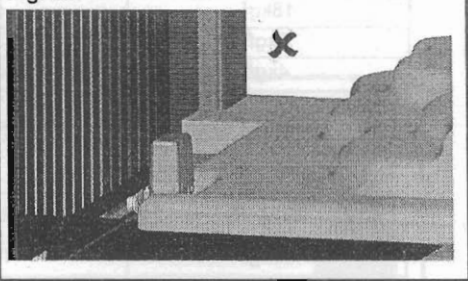

Motor mounted below flood level.

Fig. 3

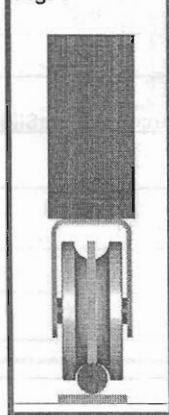

To avoid obstructions the rail should be set above ground level.

III.GATE REQUIREMENTS- it is important to note that the gate must be in good working order before the motor is installed.

The following items must be checked to ensure that the gate is in good order:

- Using a normal fishing scale, check the linear start –up force of the gate. (Fig.4)
- The rail must be level.
- Wheels must move freely.
- Rollers must run freely.
- End stoppers must be secure (minimum 70mm—see Fig. 1.1).
- Wall bracket must be secure and must not restrict the gate in any way.
- An anti lift device must be placed above the gate to avoid the gate being lifted off the rail.

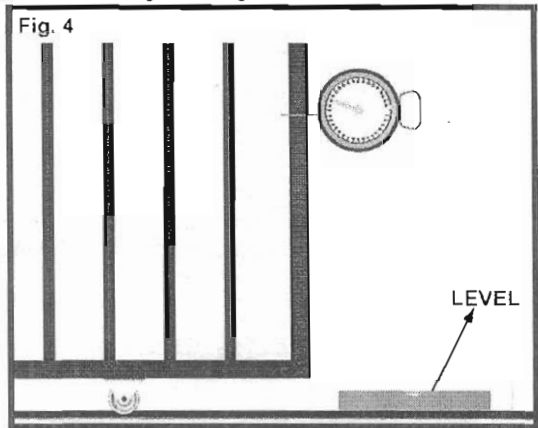

NOTE: If a gate rail is not level it may cause the gate to knock the end stops due to the inertia of the gate. D.A.C.E. will not be held responsible for any gate that hits the end stopper due to the gate rail not being level.

Maximum Linear Start up Force for DuraSlide 300 series is as follows:

Table 1.1

| <u>Start Up</u> | <u>Running</u> | <u>Openings per day</u> |
|-----------------|----------------|-------------------------|
| 18kgf | 5kgf | 20 |
| 8kgf | 3kgf | 30 |
| 4kgf | 2kgf | 40 |

Maximum Linear Start up Force for DuraSlide 500 series is as follows:

Table 1.2

| <u>Start Up</u> | <u>Running</u> | <u>Openings per day</u> |
|-----------------|----------------|-------------------------|
| 25kgf | 10kgf | 20 |
| 20kgf | 8kgf | 50 |
| 15kgf | 6kgf | 85 |
| 10kgf | 4kgf | 120 |
| 5kgf | 2.5kgf | 150 |

Maximum Linear Start up Force for DuraSlide Sprint series is as follows:

Table 1.3

| <u>Start Up</u> | <u>Running</u> | <u>Openings per day</u> |
|-----------------|----------------|-------------------------|
| 18kgf | 5kgf | 20 |
| 8kgf | 3kgf | 30 |
| 4kgf | 2kgf | 40 |

1. MOUNTING FOUNDATION PLATE (OPTION 1)

Fig. 5.1

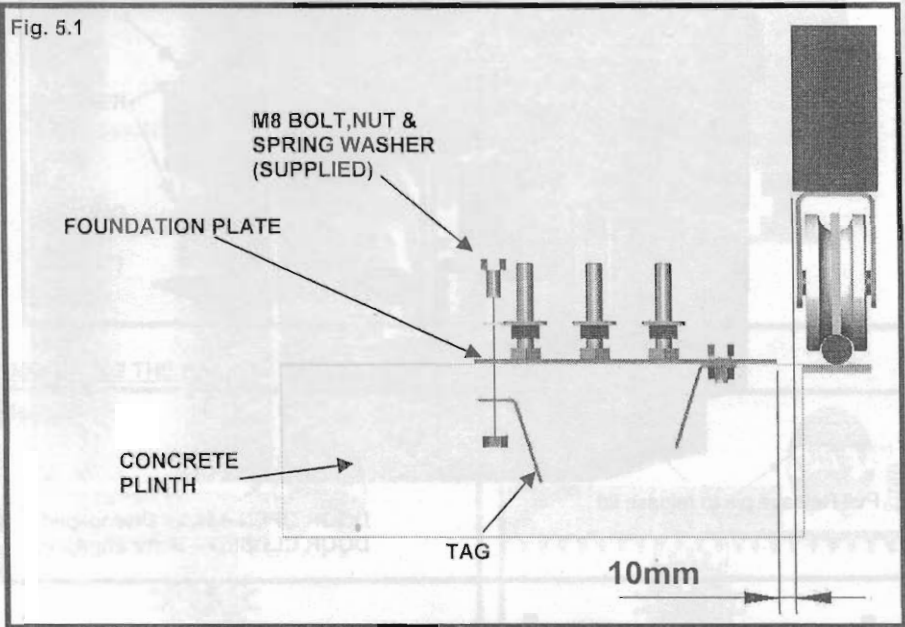

MOUNTING FOUNDATION PLATE (OPTION 2)

Fig. .5.2

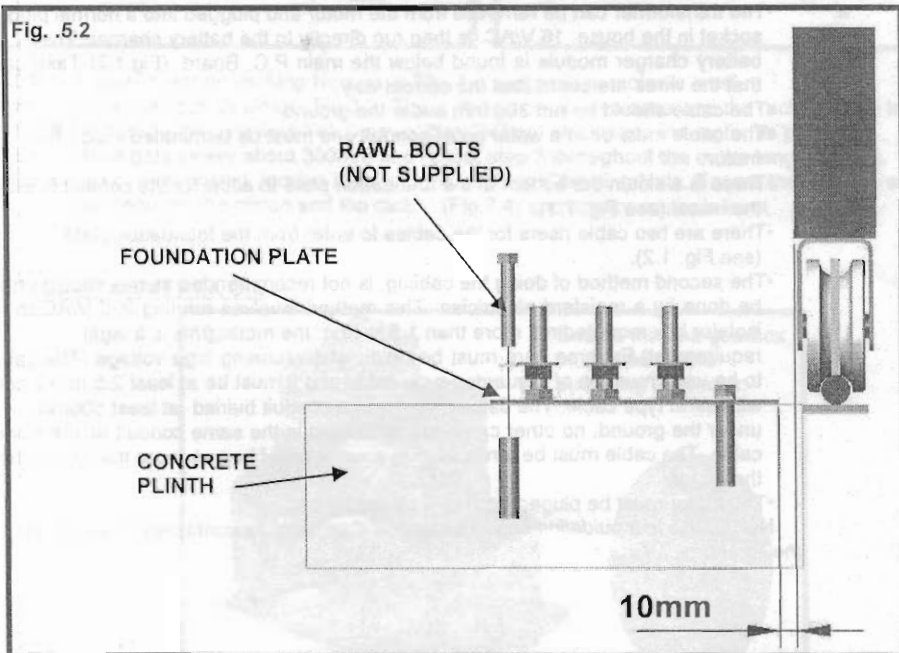

II. REMOVING THE LID—Engaging Motor

Fig. 6

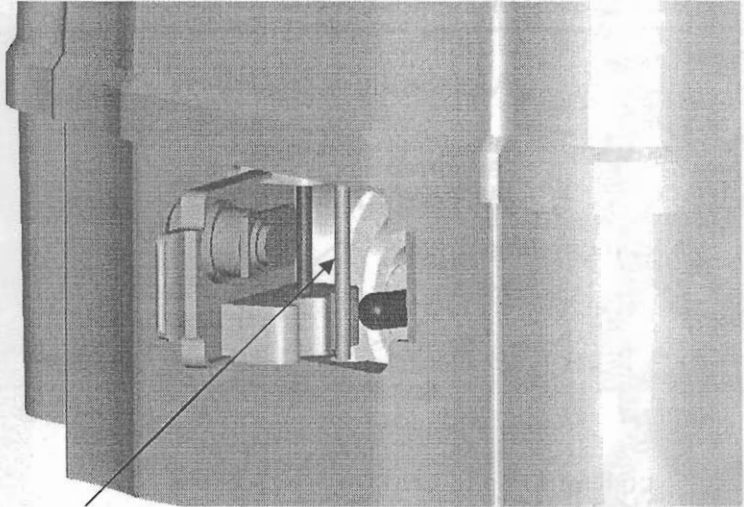

Pull Release pin to release lid

DOOR OPEN—Motor Disengaged
DOOR CLOSED—Motor Engaged

III. ELECTRICAL WIRING

The electrical wiring of the motor can be done in two ways.

- a.
 - The transformer can be removed from the motor and plugged into a normal plug socket in the house. 16 V/AC. is then run directly to the battery charger. The battery charger module is found below the main P.C. Board. (Fig.1.2) Take care that the wires are connected the correct way.
 - The cable should be run 300 mm under the ground.
 - The cable must be in a water proof conduit and must be terminated inside the motor.
 - There is a slot in the bottom of the foundation plate to allow for the conduit to enter the motor.(see Fig. 7.1).
 - There are two cable risers for the cables to enter from the foundation plate (see Fig. 1.2).
- b.
 - The second method of doing the cabling, is not recommended as this should only be done by a registerd electrician. This method involves running 220 V/AC to an isolator box mounted not more than 1,5 m from the motor (this is a legal requirement).Extreme care must be taken when running high voltage. The cable to be used must be of a guarded type cable and it must be at least 2.5 mm 2 core with earth type cable. The cable must be in a conduit buiried at least 500mm under the ground, no other cable can be placed in the same conduit as the power cable. The cable must be terminated in a water proof box no more than 1,5m from the motor.
 - The motor must be plugged into the water proof box.

NOTE: *this is a guideline only. The local E.C.A. must be contacted to establish the local regulations.*

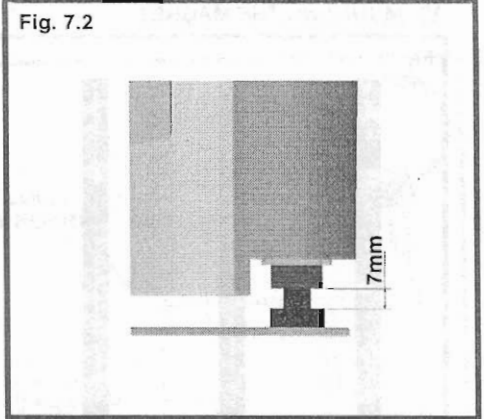
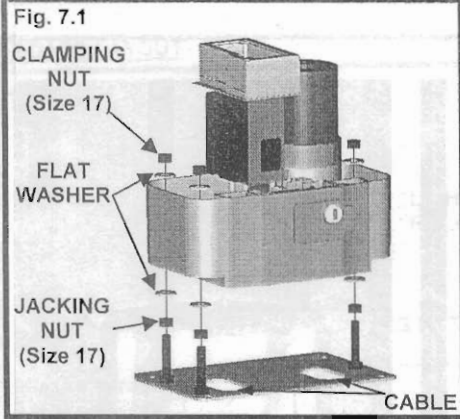

V. MOUNTING THE RACK

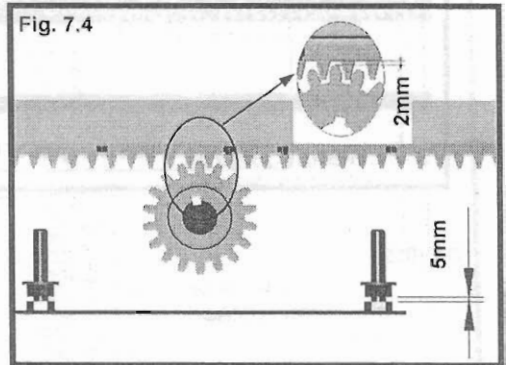
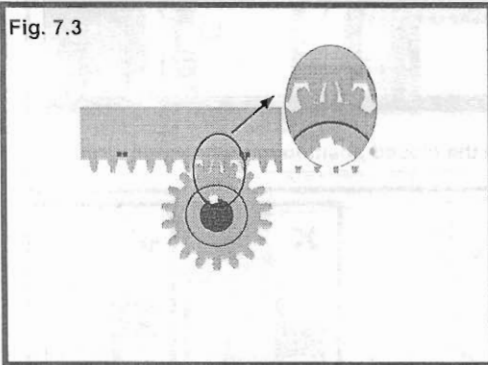

- STEP 1:** Fasten motor on Jacking Nuts as in Fig. 7.2. and ensure motor is level.
- STEP 2:** Place the rack on pinion (Fig.7.3) There should be no clearance and the rack must be level.
- STEP 3:** Fix rack to the gate with Tek Screws (Self Drilling) as close to the motor as possible..
- STEP 4:** Move gate slowly about 300mm and repeat step 3 throughout the entire length of rack.
- STEP 5:** Lower motor using Jacking Nuts and then tighten Clamping Nuts. Ensure that there is a 2mm gap between the pinion and the rack (Fig.7.4) and ensure motor is level.

VI. FILLING GEAR BOX OIL

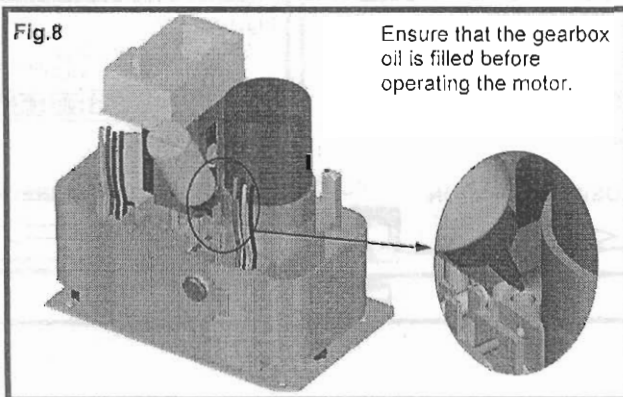

VII. MOUNTING THE MAGNET

Fig. 9.1

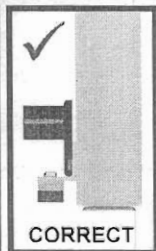
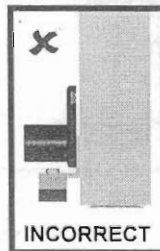
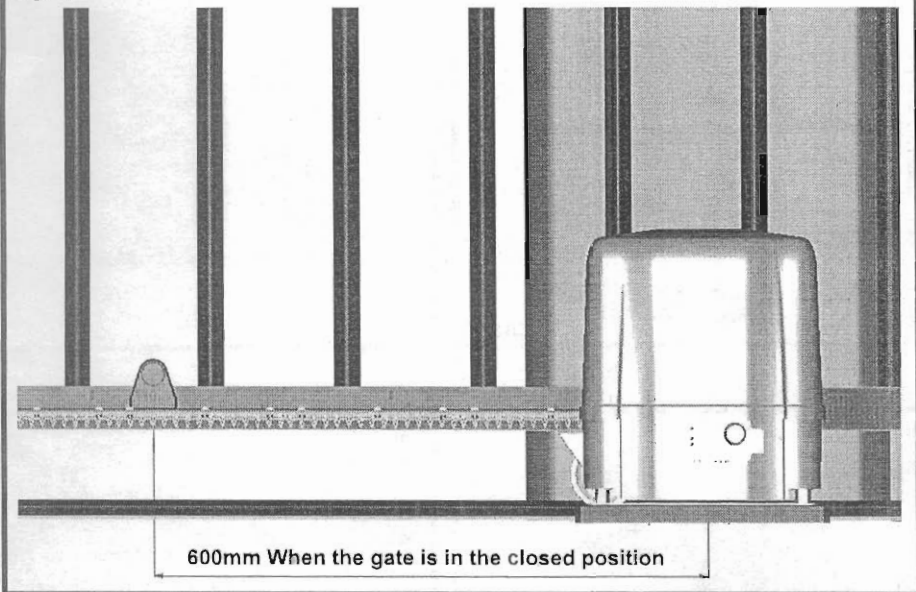

Fig. 9.2

Fig. 9.3

7. COMMISSIONING THE MOTOR

I. CHECKING MOTOR DIRECTION

Fig. 10.1

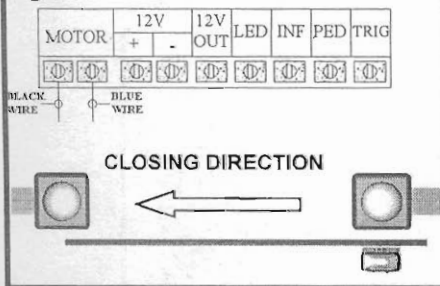
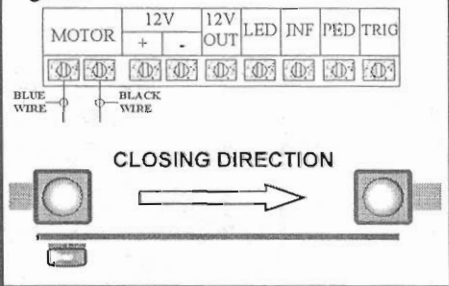
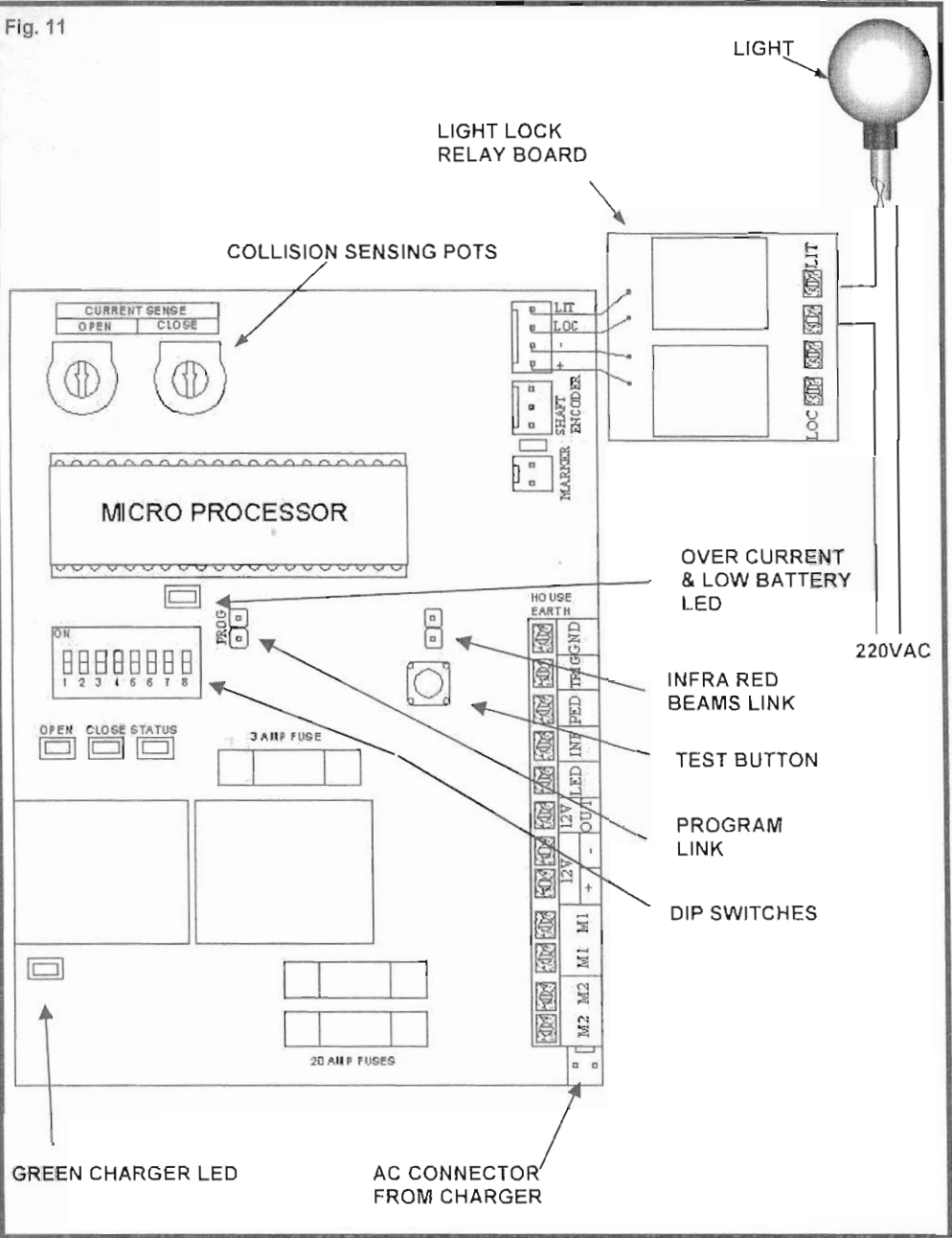

Fig.10.2



II. P.C. BOARD LAYOUT

Fig. 11



III.PROGRAMMING PROCEDURE

IT IS IMPORTANT TO NOTE THAT IF THE MAGNET IS NOT FITTED OR IS INCORRECTLY FITTED THAT THE FOLLOWING PROGRAMMING PROCEDURE WILL NOT BE SUCCESSFUL.

STEP 1 Ensure that main P.C. Board is off i.e. no LED's are on.

STEP 2 Ensure that the gate has adequate physical stoppers at both ends (see Fig.1.1).

STEP 3 Place motor in manual override. Push the gate open about 1000mm (this will be the distance that the gate opens in pedestrian mode). If a larger pedestrian opening is required then open the gate to the preferred distance before proceeding to step 4.

STEP 4 Engage the gearbox by closing the door and slowly moving the gate until a click can be heard.

STEP 5 Check motor direction is correct (see Fig. 10.1).

STEP 6 Establish what type of motor you have and select Dipswitch No. 1 accordingly (see Dipswitch Setup).

STEP 7 Enable PROGRAM MODE by connecting the PROGRAM LINK (SEE Fig. 11).

STEP 8 Connect the battery. Make sure that the battery polarity is NEVER reversed (if the polarity is reversed it will blow the P.C. Board). The red LED's will flash simultaneously at high speed indicating that the board is in PROGRAM MODE.

STEP 9 Push the TEST button. The following will occur:

- Gate moves slowly to the closed position and strikes the closed stopper.
- Gate moves slowly to the open position and strikes the open stopper.

STEP 10 Remove the PROGRAM LINK. The programming procedure is now complete.

STEP 11 Connect AC (See Fig.11).

IMPORTANT

IF AN ERROR OCCURS WHILE PROGRAMMING, REMOVE BATTERY POWER AND BEGIN FROM STEP 3.

SPECIAL NOTE

If Safety Beams are fitted to the gate, ensure that the beam is not broken during the programming sequence.

IV.COLLISION SENSING in addition to Dipswitch No. 2 the collision sensing can be increased/decreased using the Collision Sensing pots (see Fig. 11)

Using a small flat screwdriver by turning the collision sensing pots clock wise will decrease the sensitivity of the gate. This means that if the motor hits an object the gate will drive with more force.

V.DIPSWITCH SETUP

| | | |
|---------------------|---------------------------------|--|
| Dipswitch No.1 | <i>motor selection</i> | ON– 500 series / Sprint series OFF– 300 series |
| Dipswitch No. 2 | <i>collision sensing</i> | ON– Heavy gate OFF– Light Gate |
| Dipswitch No.3 | <i>multi-user mode</i> | ON– Gate will open fully regardless of any other trigger (i.e. used in town house situations. Auto Close must be selected for this function) |
| Dipswitch No.4 | <i>Reserved for future use.</i> | |
| Dipswitch No.5 to 8 | <i>Auto close function</i> | See table 2 |

TABLE 2

| Auto-Close | Switch 5 | Switch 6 | Switch 7 | Switch 8 |
|------------|----------|----------|----------|----------|
| 5 Sec | ON | OFF | OFF | OFF |
| 10 Sec | OFF | ON | OFF | OFF |
| 15 Sec | ON | ON | OFF | OFF |
| 20 Sec | OFF | ON | OFF | OFF |
| 35 Sec | ON | ON | ON | OFF |
| 40 Sec | OFF | OFF | OFF | ON |
| 75 Sec | ON | ON | ON | ON |

VI. PARTY MODE (AUTOCLOSE OVERRIDE)

- Press the test or intercom button and hold down, for ± 15 secs, until the gate starts to open. Release the button as soon as the gate is in motion. The gate will remain open.
- To get the gate to operate in normal mode press the button twice within 2 seconds. The gate will now return to normal Auto Close operation

8. CONNECTING AUXILIARY EQUIPMENT

NOTE : ENSURE THAT ALL POWER IS REMOVED FROM THE P.C. BOARD BEFORE ANY CONNECTIONS ARE DONE.

I. CONNECTING A RECEIVER

- Receiver should be mounted outside the motor.
- Ensure that remotes and the receiver are compatible

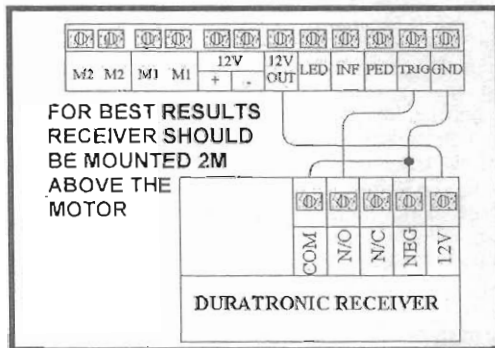
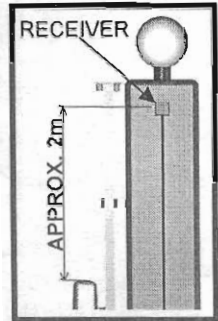

II. CONNECTING INTERCOM PUSHBUTTON /PEDESTRIAN PUSHBUTTON

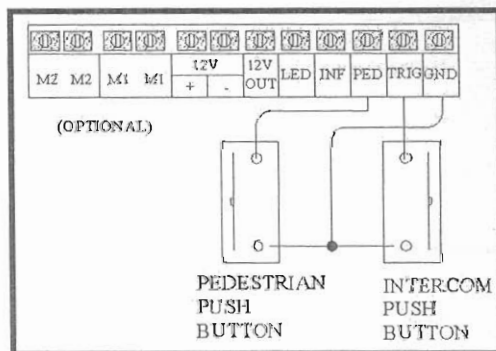

III. CONNECTING INFRA RED SAFETY BEAMS

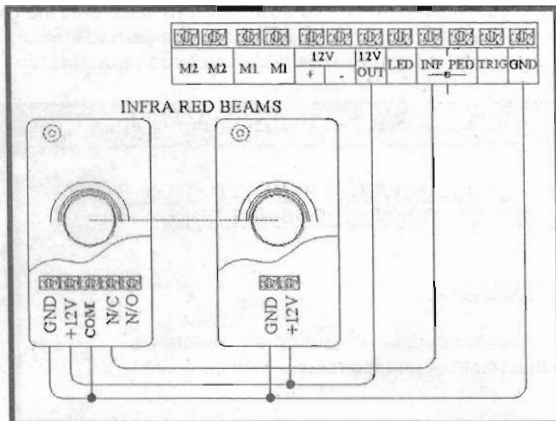

- Infrared safety beams should always be used if the gate is to be set on auto close. (see *Dipswitch settings*)
- Infrared safety beams are wired in a normally closed circuit.
- **BEAMS LINK** must be removed from the main P.C. Board once the beams have been connected. (Fig. 11)

IV. CONNECTING PILLAR LIGHT INTERFACE

- The light lock board is an optional extra that may be used to release a magnetic lock (not active with DuraSlide motors) and or switch on pillar lights. It will switch when the board receives a trigger signal i.e. from a remote or intercom.
- The lights will remain on for 4 minutes and then they will switch off automatically.
- To connect the light lock board (Fig. 11)

V. CONNECTING GATE STATUS INDICATOR.

- A status L.E.D. can be connected to identify the position of the gate from a remote location i.e. inside the house.
- The L.E.D. is normally mounted on the intercom handset.
- The L.E.D. is connected to the main P.C. Board
- The status flashes are as follows:
 - * One flash every two seconds -- gate is in the closed position and the A.C. is connected
 - * Status light on solidly -- gate is in open position.
 - * Status light flashing once per second -- gate is in motion.

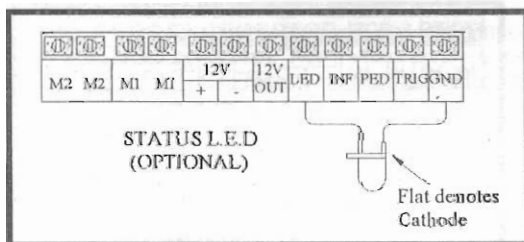

VI. LIGHTNING SUPPRESSION

For adequate Lightning Suppression ensure that the motor is earthed correctly through the mains earth.

9. WARRANTY

The motor, gearbox and P.C.B. are warranted for a period of two years.

The following conditions apply to the warranty:

- Warranty does not apply if the goods are subject to misuse.
- Warranty does not apply if the goods are installed contrary to the specifications as laid out by D.A.C.E cc.
- Warranty does not apply if any attempt has been made to repair the goods by any workshop and/or person not authorised to do so by D.A.C.E. cc.
- Warranty does not apply if the goods have been repaired using components not tested, passed or authorised by D.A.C.E cc.
- Warranty only covers repair, components and labour. It does not include transport, postage and railage which will be for the account of the purchaser.
- Warranty does not cover corrosion, insect damage or Acts of God.
- The 7AH Battery and Transformer are covered by a one year warranty.

NOTE

This is a factory warranty and the product is to be sent to the factory for repair. This is not an on-site warranty.

10. TECHNICAL SPECIFICATIONS

- **Motor:** 12 V/DC
- **Transformer:** 220 V/AC input to 16 V/AC output
- **Fuses:** motor 20 amps
12 V output 3 amps

I. DuraSlide 300 Series

- The 300 series uses a 12 V/DC 100 w motor.
- In the event of a power failure, the battery will do +- 80 operations depending on gate size and mass.
- The maximum gate size for the 300 series is 11m long.
- The 300 Series is designed as a domestic type gate operator.
- The maximum number of openings per day is 50 dependant on gate mass (See Table 1.1)
- The maximum gate mass is 300 kg.
- The 300 Series has a nominal speed of 19 m per minute
- The colour of the badge is grey.

II. DuraSlide 500 Series

- The 500 Series uses a 12V/DC. 120w motor.
- In the event of power failure the motor will do +- 50 operations.
- The maximum size of the gate is 11m long.
- The motor can be used in a complex situation with a maximum of 30 units.
- The maximum number of openings per day is 120 dependant on gate mass (see Table 1.2).
- The maximum gate mass is 500kg.
- The 500 series has a nominal speed of 20m per minute.
- The colour of the badge is green

III. DuraSlide Sprint

- The Sprint Series uses a 12V/DC. 120w motor. The motor has the same charging system as the 300 series.
- In the event of a power failure the motor will do +- 50 operations.
- The maximum gate size is 11m long.
- This motor can be used in a housing complex situation with a maximum of 30units.
- The maximum gate mass is 300kg.
- The maximum number of openings per day is approximately 120 dependant on gate mass (see Table 1.3).
- The Sprint series has a nominal speed of 24 m per minute.
- The colour of the badge is bronze

MOTOR DIMENSIONS

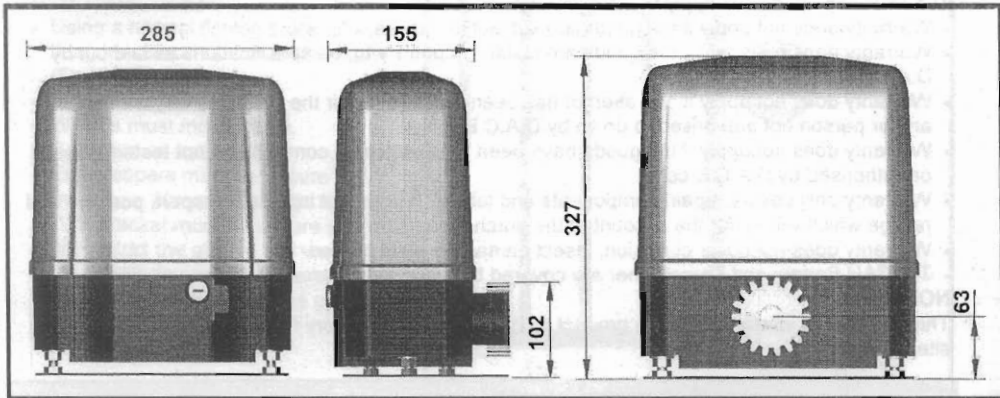

11. TROUBLE SHOOTING

LED DIAGNOSTICS

Table 3

| STATUS LED FLASHES | FAULT | ACTION |
|--------------------|---|--|
| 2 or 3 flashes | -Blown motor fuse -Motor wires out or loose, -Brushes worn -Low battery -Blown track on P.C.B. | Remove and test fuses, Check motor wires are tight, Check brushes. Check battery Return P.C.B for repairs. |
| 4 flashes | -Shaft encoder unplugged -Shaft encoder dirty -Blown track on P C Board | Check encoder plug is on Remove encoder and check for dirt etc. If P.C.B. has blown track, return for repairs. |
| 5 flashes | -Reed switch faulty | Replace |
| 6 flashes | -Shaft encoder sensor dirty or damaged | Clean sensor or replace |

OVER CURRENT AND LOW BATTERY LED (See Fig. 11)

| | | |
|---------------------|---------------|---|
| Yellow LED flashing | -Flat battery | Replace or re-charge |
| Yellow ON solid | -Over current | Check motor or gate for obstructions |

Table 3.1

| SYMPTOM | CAUSE | ACTION |
|--|--|---|
| Motor will not open or close using remote | -RX coding incorrect -Receiver faulty. -3 amp fuse blown. -Receiver wiring fault. -False trigger, check all other triggers. Remove and replace one at a time | Check RX coding Try spare TX or RX Test fuse Check wiring |
| Motor operates without any trigger (opens and closes on its own !) | -Receiver wiring fault. -False trigger, | -Check all other triggers. -Remove and replace one at a time |
| Motor will not open or close using intercom but works from TX button | -Cable fault -Dead short | Remove all triggers Bridge TRIG and GND on P.C.B if it works, check cable |
| Motor will not trigger using both remote and intercom but will trigger using test button | -Trigger circuit faulty on P.C.B. | Return for repairs |
| Motor will not open using test button | -Dead short -Blown motor fuse -Flat battery -P.C.B fault | Remove all triggers Test fuse Do FULL battery test Return for repairs |
| Motor will not close | As no 4 -Beams link removed -Beams faulty -Beams cable fault | Check beams link is on Isolate beams using link Check continuity |
| Motor runs then suddenly stops | -Loose battery wires. -Encoder not plugged on -Encoder dirty / faulty | Check battery wires Check encoder plug Count status light (4 flashes) |
| Motor opens and closes on its own | -Neighbour has same TX code -Faulty intercom / RX wires -P.C.B. faulty | Change code Remove all triggers Return for repairs |
| Motor runs slowly then stops and clicking noise heard | -Flat battery | Test battery (full test) Check charger and cables |
| Motor runs open instead of closed in programme mode | -Motor wires wrong way | Remove and reverse |
| Motor closes then opens after certain time period | -Motor wires wrong way and auto close selected | As above |
| Motor runs closed in programme mode hits stop but will not open | -Flat battery -P.C.B. faulty -Shaft encoder faulty | Test battery Return for repairs Remove prog link press and count status LED |
| Motor opens but closes immediately | No 3 dipswitch is on | Switch 3 off or select auto close |
| 3 amp fuse blown | Dead short | Check wiring and replace fuse |
| Motor fuse blowing | -Gate has hit an obstruction -Gate hit end stop -Faulty motor | Check rail for obstructions Check shaft encoder |

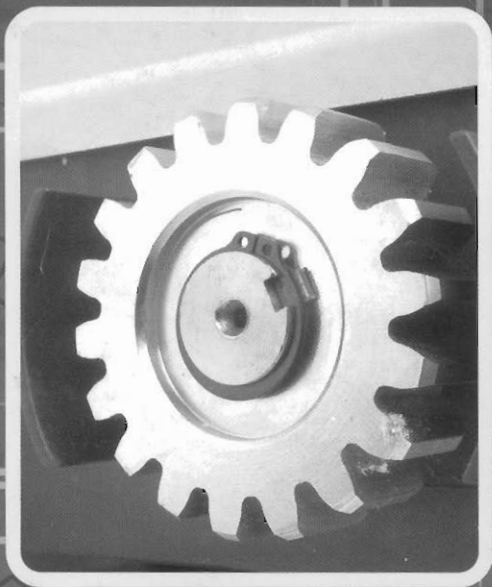

5 Van Der Bijl Rd, New Germany,
Box 1840,
New Germany 3620

TEL: (031) 705 6644
FAX: (031) 705 3441
WEBSITE: www.duraproducts.co.za