

# Turnierpläne

In der Broschüre Turnierformen sind die Beschreibungen der hier abgebildeten Turnierpläne zu finden.

Bezugsquelle: Bundesamt für Sport Magglingen  
J+S-Dokumentation  
2532 Magglingen  
E-mail: dok.js@baspo.admin.ch

## Weitere Informationen

Bei den unten aufgeführten Verbänden erhältst du weitere Informationen.

**swiss badminton**  
[www.badminton.ch](http://www.badminton.ch)

**SWISS SQUASH**  
[www.squash.ch](http://www.squash.ch)

**Swiss Tennis**  
[www.myTennis.ch](http://www.myTennis.ch)

**Schweizerischer Tischtennis-Verband**  
[www.sttv.ch](http://www.sttv.ch)



# K.O.-Turnier

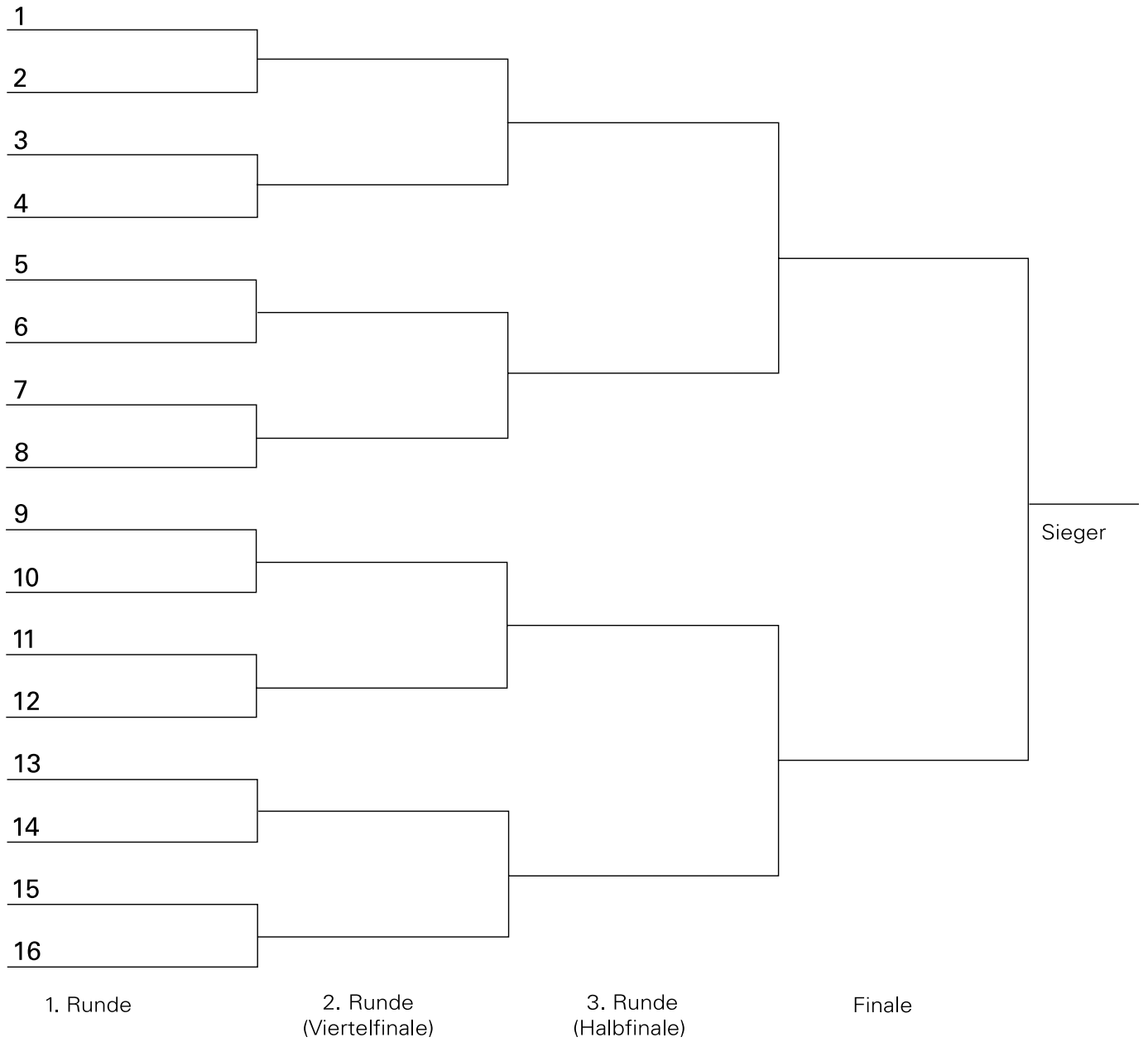
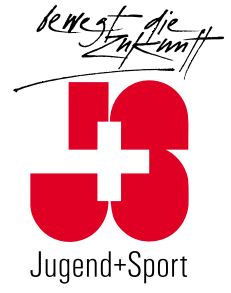

# K.O.-Turnier

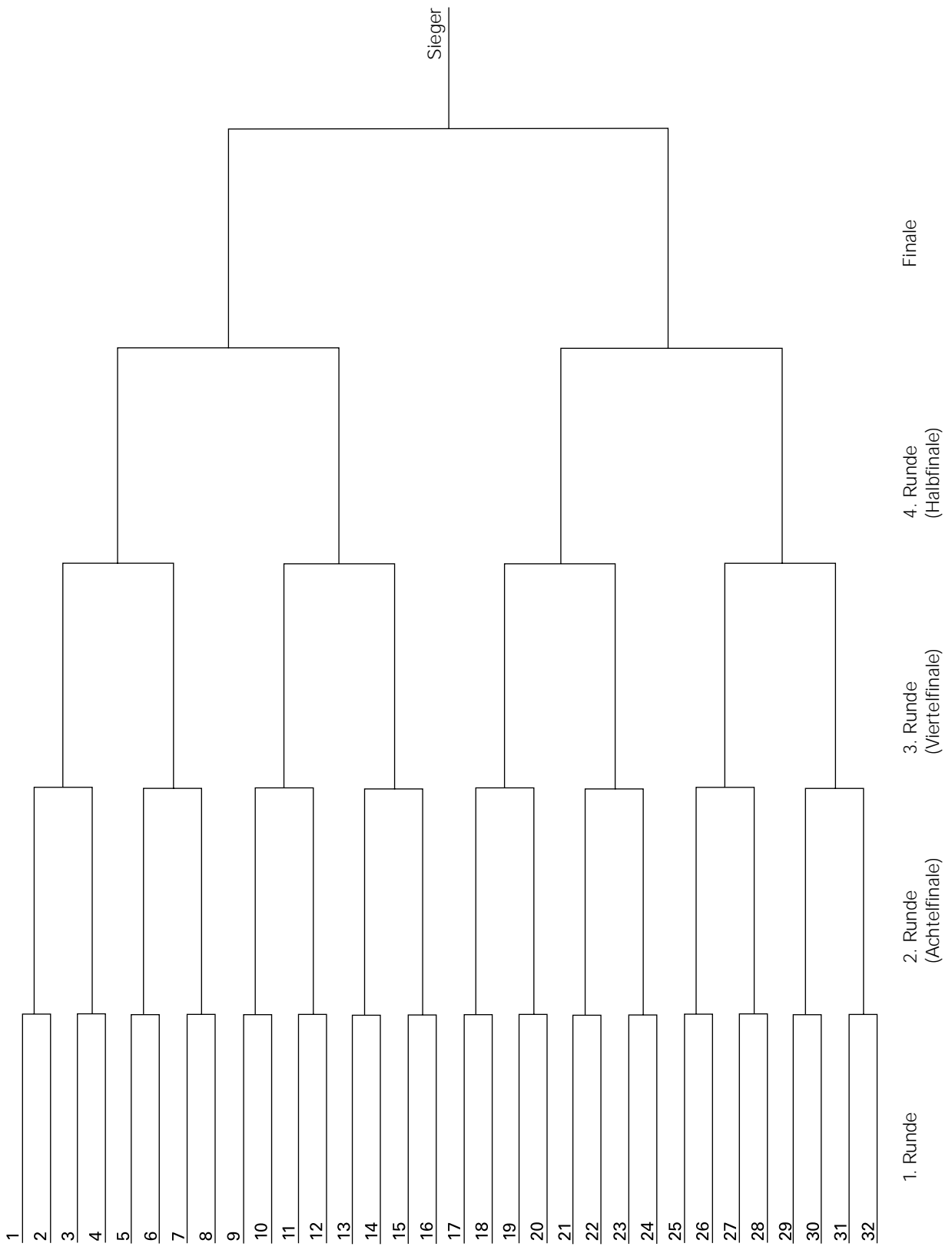
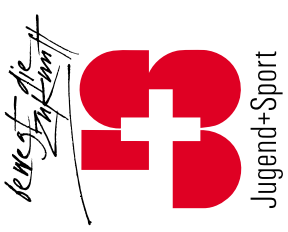

# Doppeltes K.O.-Turnier

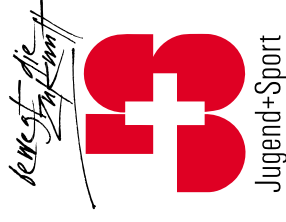

## Trostrunde (Verliererseite)

## Hauptrunde (Gewinnerseite)

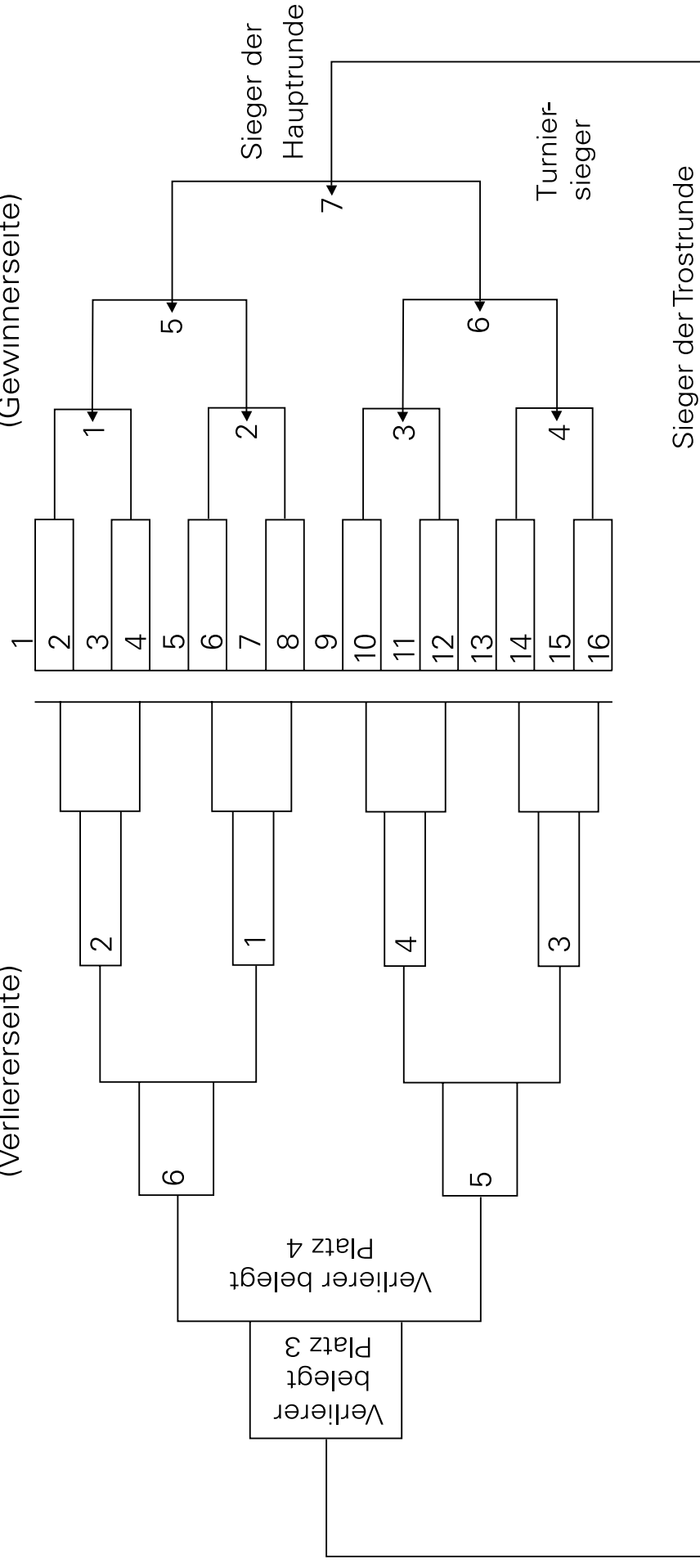

# Doppeltes K.O.-Turnier

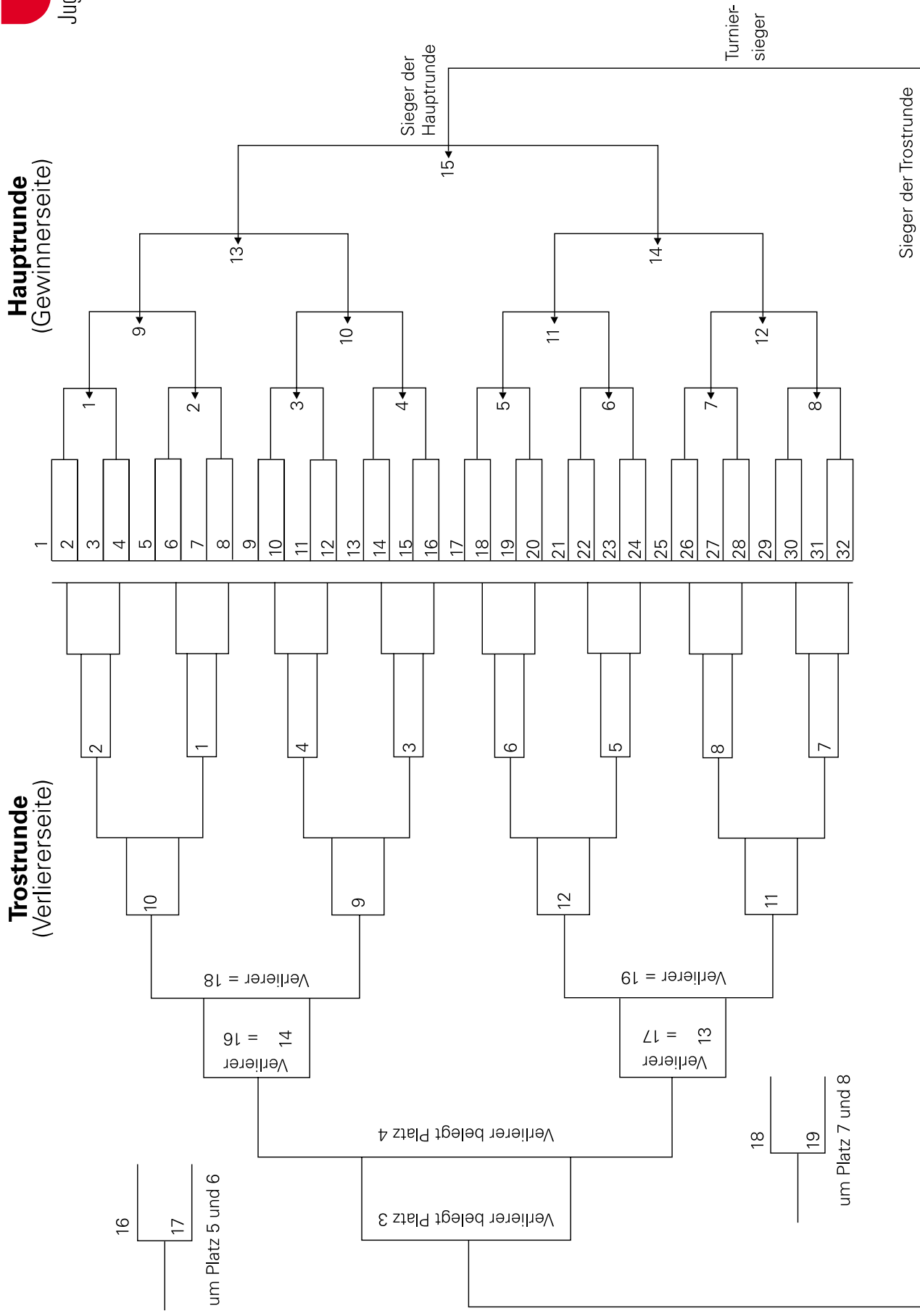
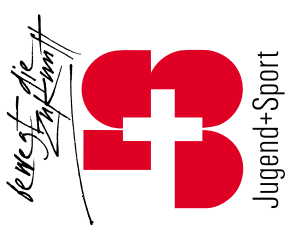

# Ranglistenturnier

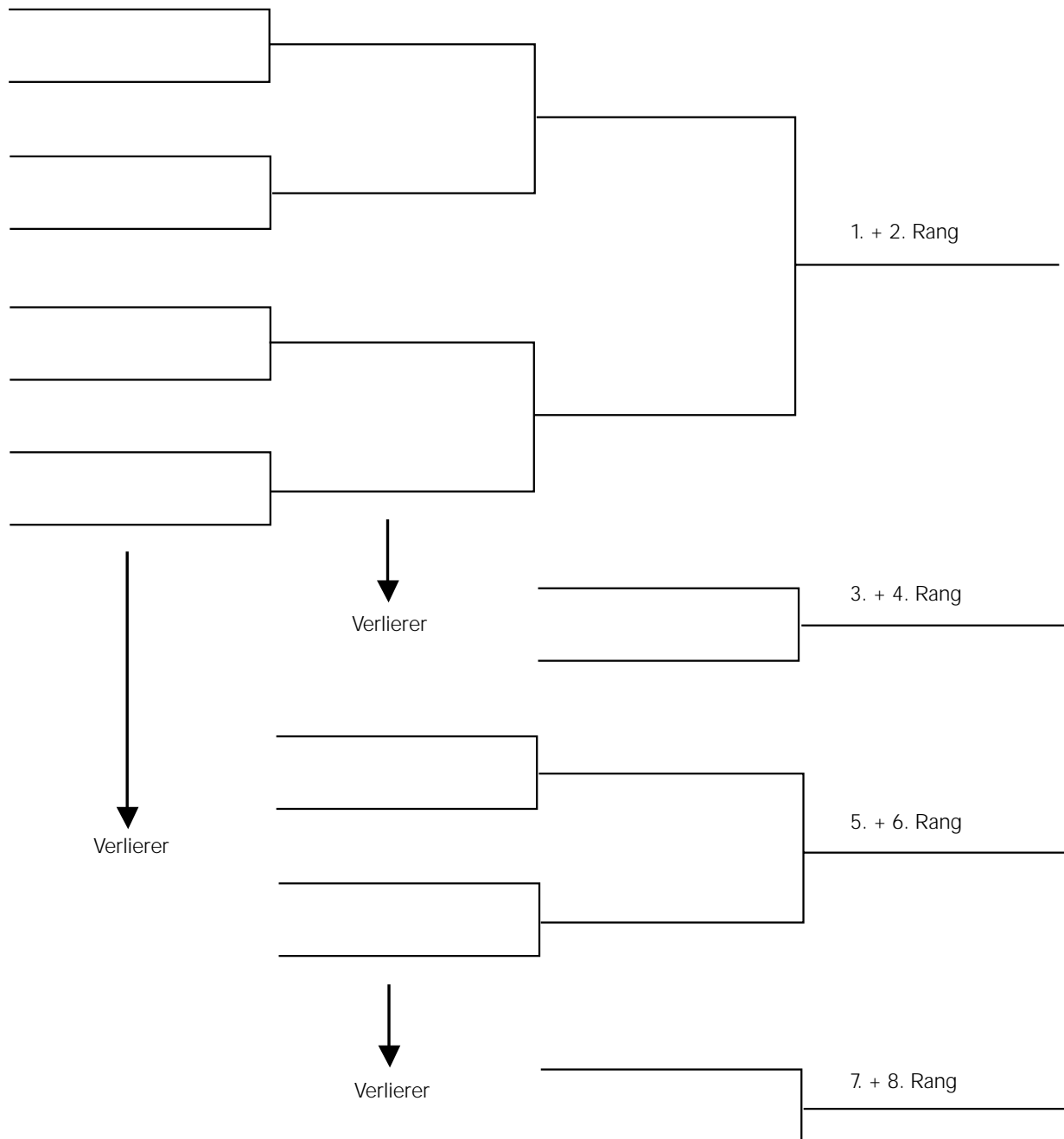
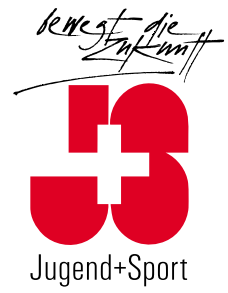

# Ranglistenturnier

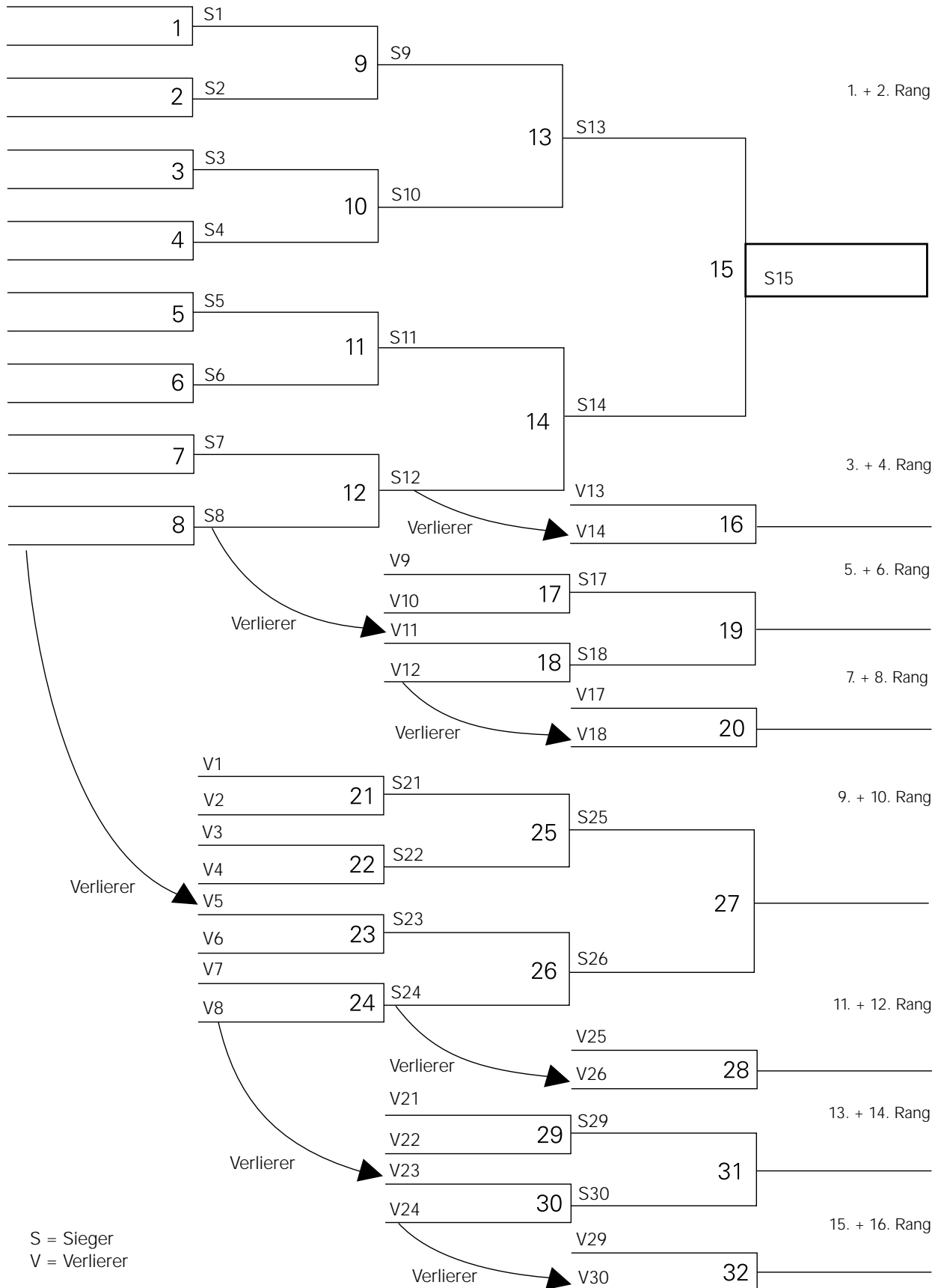
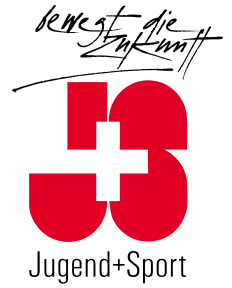

# Ranglistenturnier

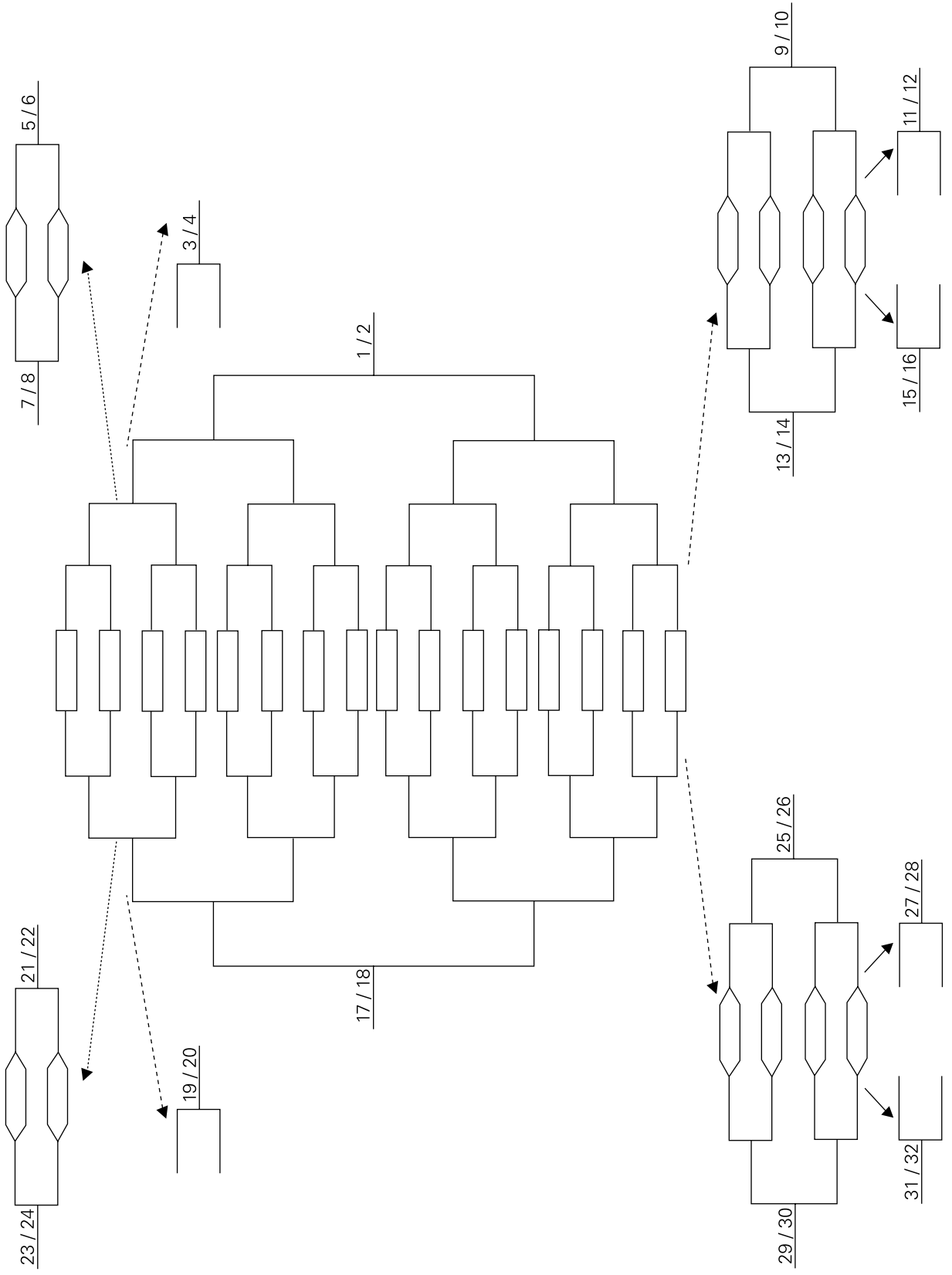



# K.O.-Pool-Turnier

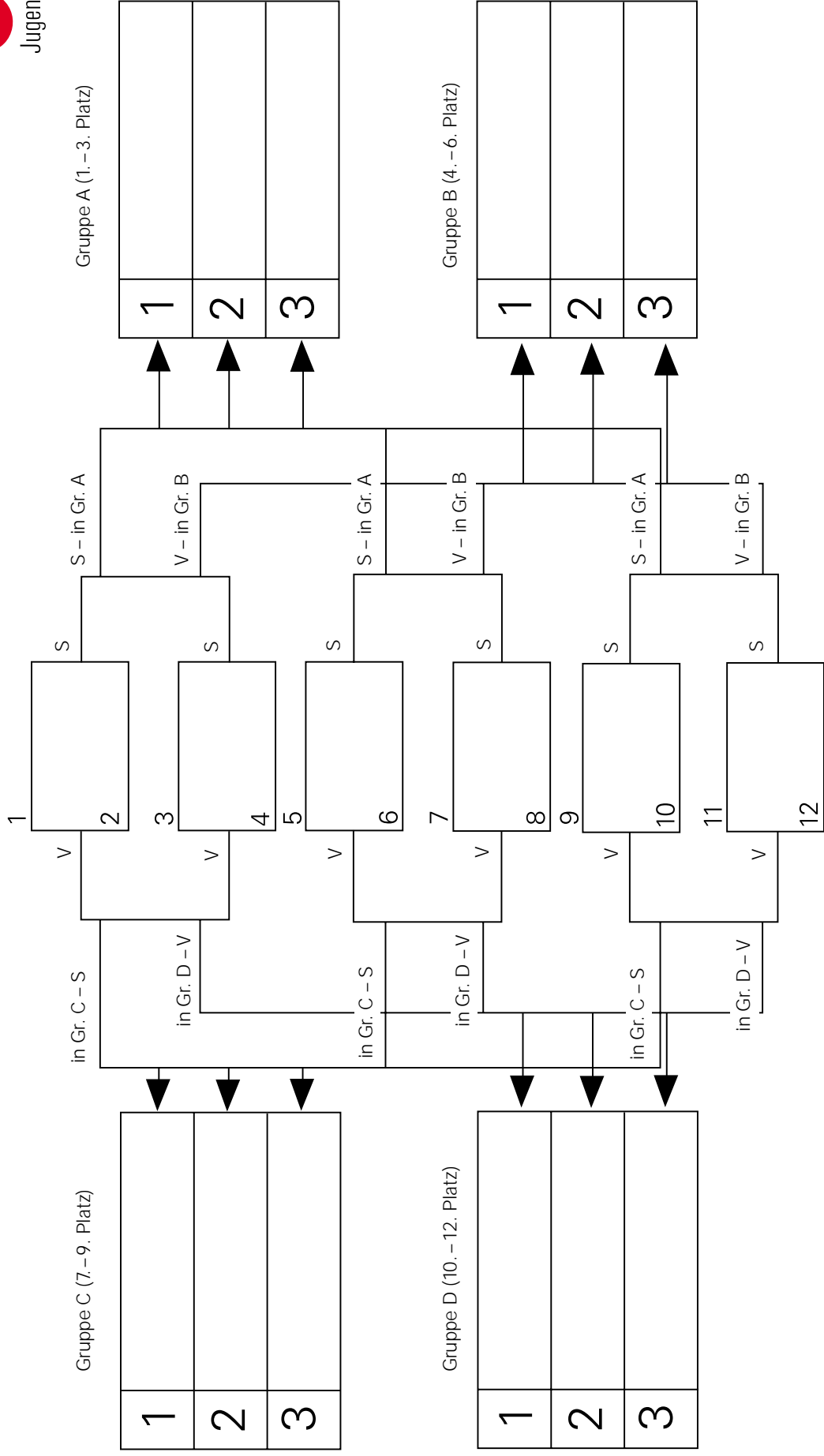
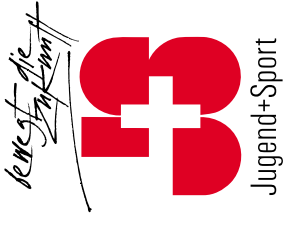

S = Sieger  
V = Verlierer

# K.O.-Pool-Turnier

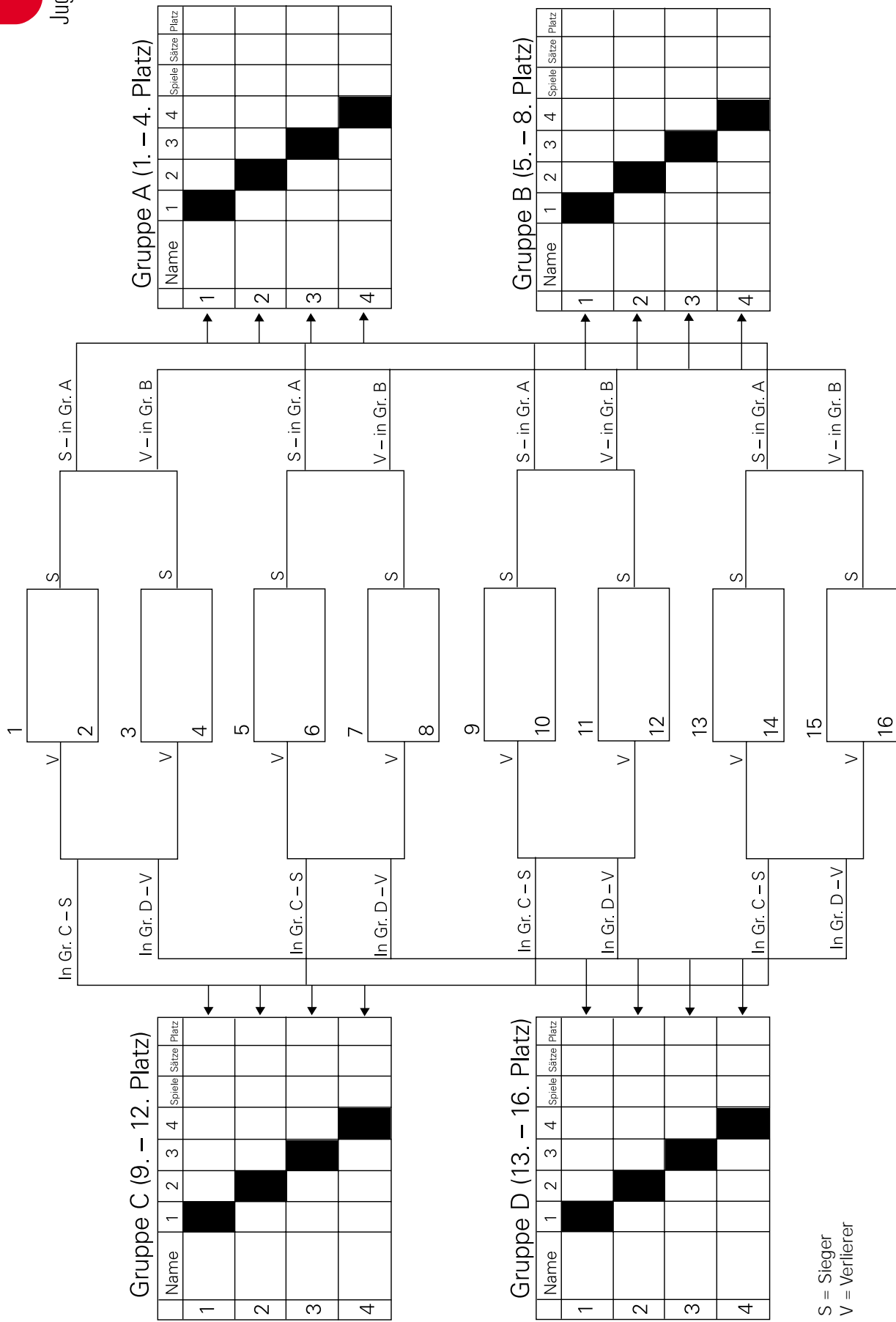
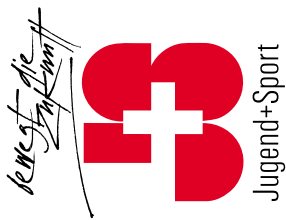

S = Sieger  
V = Verlierer

# Gruppen-K.O.-Turnier

Gruppe A

|   | Name | 1 | 2 | 3 | 4 | Spiele | Sätze | Platz |
|---|------|---|---|---|---|--------|-------|-------|
| 1 |      | ■ |   |   |   |        |       |       |
| 2 |      |   | ■ |   |   |        |       |       |
| 3 |      |   |   | ■ |   |        |       |       |
| 4 |      |   |   |   | ■ |        |       |       |

Gruppe B

|   | Name | 1 | 2 | 3 | 4 | 5 | Spiele | Sätze | Platz |
|---|------|---|---|---|---|---|--------|-------|-------|
| 1 |      | ■ |   |   |   |   |        |       |       |
| 2 |      |   | ■ |   |   |   |        |       |       |
| 3 |      |   |   | ■ |   |   |        |       |       |
| 4 |      |   |   |   | ■ |   |        |       |       |
| 5 |      |   |   |   |   | ■ |        |       |       |

A1 = 1. von Gruppe A  
 B2 = 2. von Gruppe B  
 S = Sieger  
 V = Verlierer

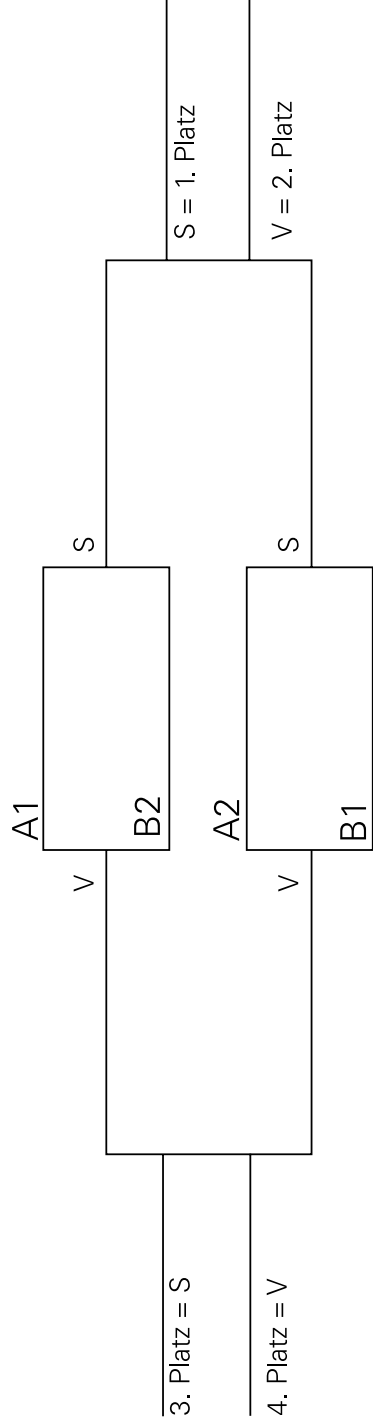

# Gruppen-K.O.-Turnier



Gruppe A

|   | Name | 1 | 2 | 3 | 4 | Spiele | Sätze | Platz |
|---|------|---|---|---|---|--------|-------|-------|
| 1 |      |   |   |   |   |        |       |       |
| 2 |      |   |   |   |   |        |       |       |
| 3 |      |   |   |   |   |        |       |       |
| 4 |      |   |   |   |   |        |       |       |

Gruppe B

|   | Name | 1 | 2 | 3 | 4 | Spiele | Sätze | Platz |
|---|------|---|---|---|---|--------|-------|-------|
| 1 |      |   |   |   |   |        |       |       |
| 2 |      |   |   |   |   |        |       |       |
| 3 |      |   |   |   |   |        |       |       |
| 4 |      |   |   |   |   |        |       |       |

Gruppe C

|   | Name | 1 | 2 | 3 | 4 | Spiele | Sätze | Platz |
|---|------|---|---|---|---|--------|-------|-------|
| 1 |      |   |   |   |   |        |       |       |
| 2 |      |   |   |   |   |        |       |       |
| 3 |      |   |   |   |   |        |       |       |
| 4 |      |   |   |   |   |        |       |       |

Gruppe D

|   | Name | 1 | 2 | 3 | 4 | Spiele | Sätze | Platz |
|---|------|---|---|---|---|--------|-------|-------|
| 1 |      |   |   |   |   |        |       |       |
| 2 |      |   |   |   |   |        |       |       |
| 3 |      |   |   |   |   |        |       |       |
| 4 |      |   |   |   |   |        |       |       |

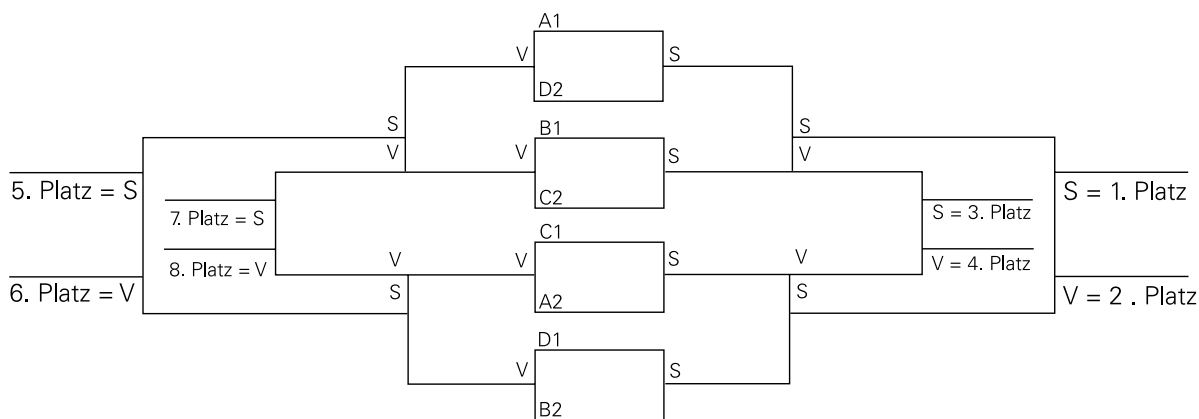

A1 = 1. von Gruppe A  
 B2 = 2. von Gruppe B  
 S = Sieger  
 V = Verlierer

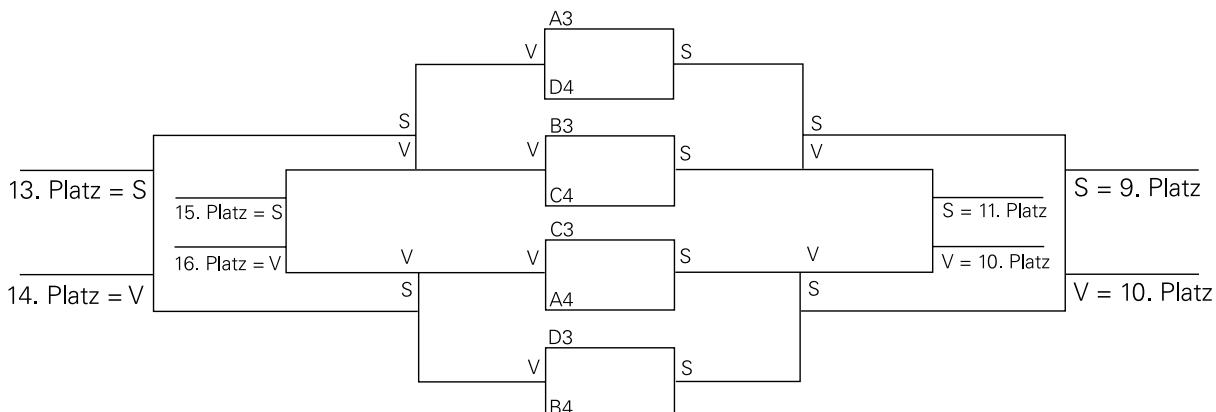

# Kästliturnier

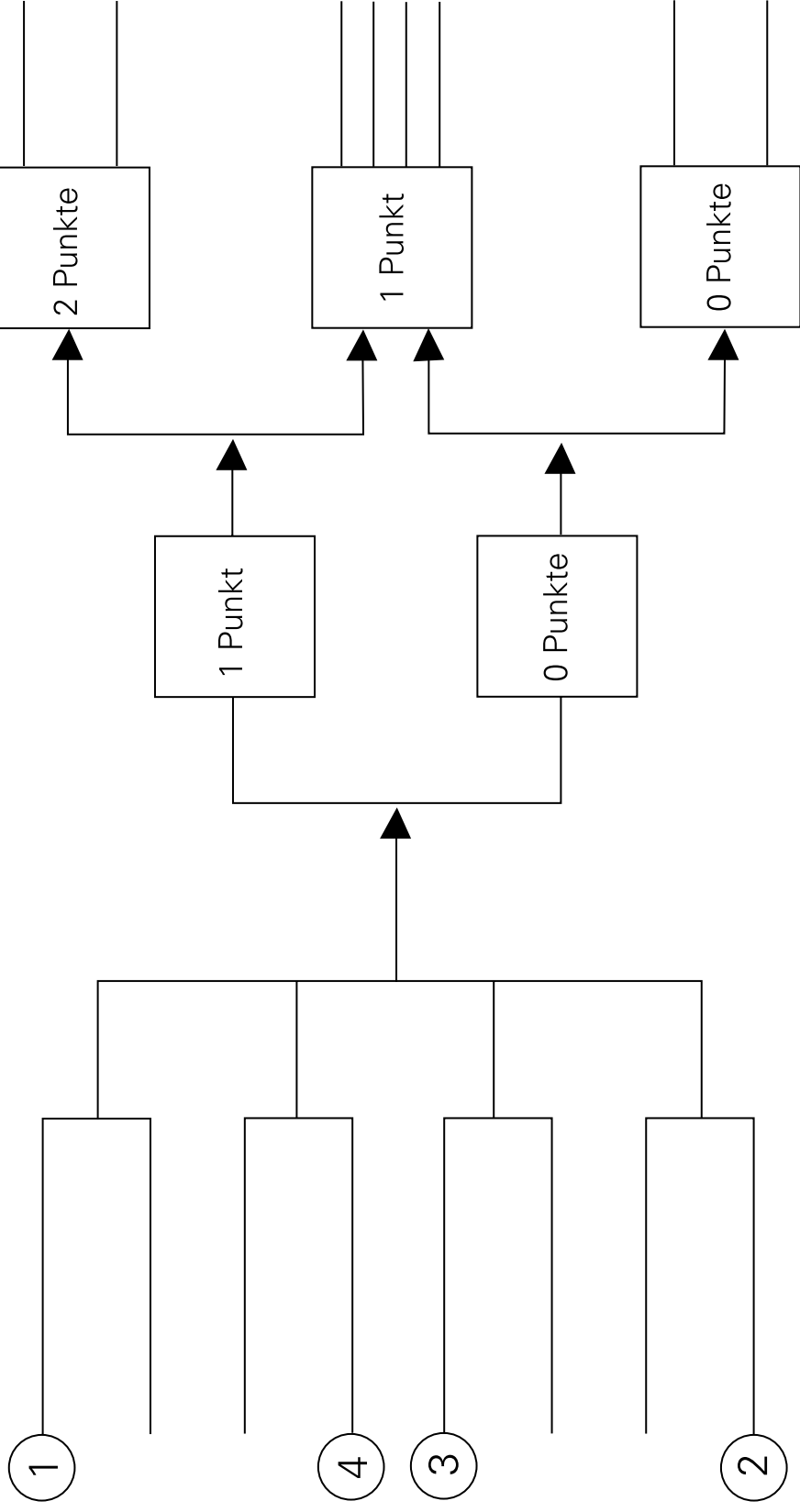

○ gesetzte Spieler Nr. 1 – 4

# Kästliturnier

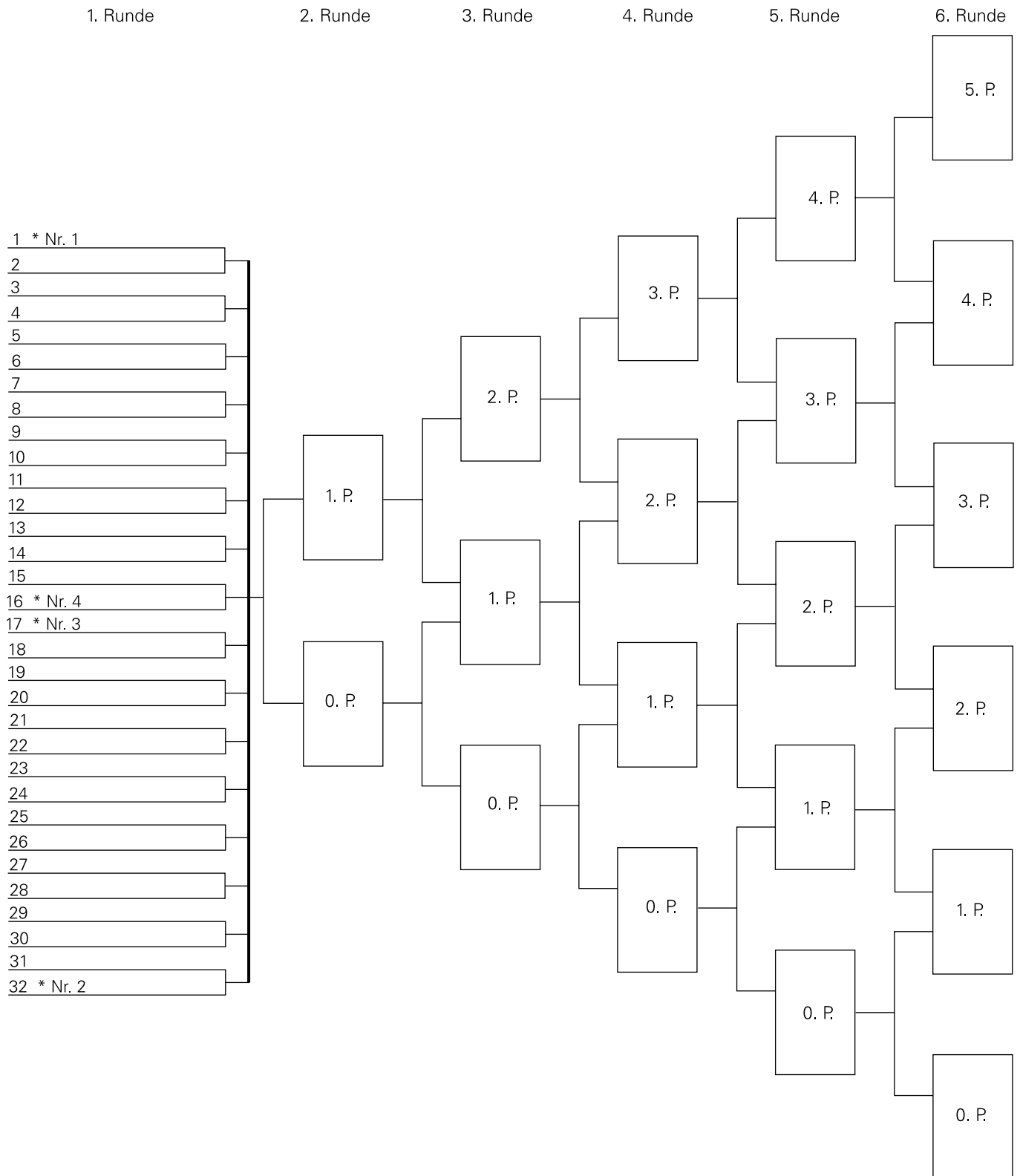
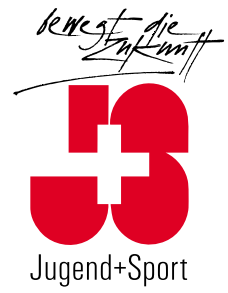

Jeder gegen jeden



| Spielplan |       |   |   |   | 4/2 |
|-----------|-------|---|---|---|-----|
| A         | B     | 1 | 2 | 3 | 4   |
|           |       |   |   |   |     |
| 1 – 2     | 3 – 4 |   |   |   |     |
| 4 – 3     | 2 – 1 |   |   |   |     |
| 4 – 2     | 3 – 1 |   |   |   |     |
| 1 – 3     | 2 – 4 |   |   |   |     |
| 2 – 3     | 1 – 4 |   |   |   |     |
| 4 – 1     | 3 – 2 |   |   |   |     |
| Total     |       |   |   |   |     |

Spielplan für 4 Mannschaften (1 – 4) mit 2 Spielfeldern (A – B)

Jeder gegen jeden

| Spielplan |     | 5/2 |   |   |   |   |
|-----------|-----|-----|---|---|---|---|
| A         | B   | 1   | 2 | 3 | 4 | 5 |
|           |     |     |   |   |   |   |
| 4-2       | 3-1 |     |   |   |   |   |
| 3-2       | 5-4 |     |   |   |   |   |
| 1-4       | 2-5 |     |   |   |   |   |
| 5-3       | 2-1 |     |   |   |   |   |
| 1-5       | 4-3 |     |   |   |   |   |
| Total     |     |     |   |   |   |   |

Spielplan für 5 Mannschaften (1 – 5) mit 2 Spielfeldern (A – B)



Jeder gegen jeden

| Spielplan |     | 6/2 |   |   |   |   |   |
|-----------|-----|-----|---|---|---|---|---|
| A         | B   | 1   | 2 | 3 | 4 | 5 | 6 |
|           |     |     |   |   |   |   |   |
| 2-4       | 1-3 |     |   |   |   |   |   |
| 3-5       | 4-6 |     |   |   |   |   |   |
| 1-4       | 5-2 |     |   |   |   |   |   |
| 6-3       | 2-1 |     |   |   |   |   |   |
| 3-2       | 4-5 |     |   |   |   |   |   |
| 5-6       | 4-3 |     |   |   |   |   |   |
| 5-1       | 2-6 |     |   |   |   |   |   |
| 6-1       |     |     |   |   |   |   |   |
| Total     |     |     |   |   |   |   |   |

Spielplan für 6 Mannschaften (1 – 6) mit 2 Spielfeldern (A – B)

Jeder gegen jeden



| Spielplan |     | 6/3 |   |   |   |   |   |   |
|-----------|-----|-----|---|---|---|---|---|---|
| A         | B   | C   | 1 | 2 | 3 | 4 | 5 | 6 |
|           |     |     |   |   |   |   |   |   |
| 3-1       | 2-4 | 6-5 |   |   |   |   |   |   |
| 4-6       | 5-3 | 1-2 |   |   |   |   |   |   |
| 3-2       | 6-1 | 5-4 |   |   |   |   |   |   |
| 5-2       | 1-4 | 3-6 |   |   |   |   |   |   |
| 1-5       | 2-6 | 4-3 |   |   |   |   |   |   |
| Total     |     |     |   |   |   |   |   |   |

Spielplan für 6 Mannschaften (1 - 6) mit 3 Spielfeldern (A - C)

Jeder gegen jeden

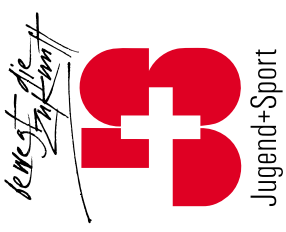

| Spielplan |     |     |   |   |   |   |   | 7/3 |   |
|-----------|-----|-----|---|---|---|---|---|-----|---|
| A         | B   | C   | 1 | 2 | 3 | 4 | 5 | 6   | 7 |
| 1-6       | 2-5 | 3-4 |   |   |   |   |   |     |   |
| 7-5       | 1-4 | 2-3 |   |   |   |   |   |     |   |
| 6-4       | 7-3 | 1-2 |   |   |   |   |   |     |   |
| 5-3       | 6-2 | 7-1 |   |   |   |   |   |     |   |
| 4-2       | 5-1 | 6-7 |   |   |   |   |   |     |   |
| 3-1       | 4-7 | 5-6 |   |   |   |   |   |     |   |
| 2-7       | 3-6 | 4-5 |   |   |   |   |   |     |   |
| Total     |     |     |   |   |   |   |   |     |   |

Spielplan für 7 Mannschaften (1 - 7) mit 3 Spielfeldern (A - C)

Jeder gegen jeden



| Spielplan |     | 8/3 |   |   |   |   |   |   |   |   |
|-----------|-----|-----|---|---|---|---|---|---|---|---|
| A         | B   | C   | 1 | 2 | 3 | 4 | 5 | 6 | 7 | 8 |
| 1-8       | 2-6 | 3-5 |   |   |   |   |   |   |   |   |
| 5-1       | 4-2 |     |   |   |   |   |   |   |   |   |
| 7-6       | 4-8 | 1-3 |   |   |   |   |   |   |   |   |
| 6-5       | 3-7 | 8-2 |   |   |   |   |   |   |   |   |
| 2-3       | 5-4 | 7-1 |   |   |   |   |   |   |   |   |
| 5-8       | 3-6 | 1-4 |   |   |   |   |   |   |   |   |
| 4-7       | 2-5 | 8-6 |   |   |   |   |   |   |   |   |
| 1-2       | 8-3 | 7-5 |   |   |   |   |   |   |   |   |
| 4-3       | 6-1 | 7-2 |   |   |   |   |   |   |   |   |
| 8-7       | 4-6 |     |   |   |   |   |   |   |   |   |
| Total     |     |     |   |   |   |   |   |   |   |   |

Spielplan für 8 Mannschaften (1 – 8) mit 3 Spielfeldern (A – C)

Jeder gegen jeden



| Spielplan |     |     |     |   |   |   |   |   |   | 8/4 |   |
|-----------|-----|-----|-----|---|---|---|---|---|---|-----|---|
| A         | B   | C   | D   | 1 | 2 | 3 | 4 | 5 | 6 | 7   | 8 |
|           |     |     |     |   |   |   |   |   |   |     |   |
| 1-8       | 2-7 | 3-6 | 5-4 |   |   |   |   |   |   |     |   |
| 7-8       | 6-1 | 5-2 | 4-3 |   |   |   |   |   |   |     |   |
| 3-2       | 8-5 | 1-4 | 6-7 |   |   |   |   |   |   |     |   |
| 5-6       | 7-4 | 8-3 | 2-1 |   |   |   |   |   |   |     |   |
| 3-7       | 2-6 | 8-4 | 1-5 |   |   |   |   |   |   |     |   |
| 4-2       | 5-3 | 7-1 | 6-8 |   |   |   |   |   |   |     |   |
| 4-6       | 1-3 | 7-5 | 2-8 |   |   |   |   |   |   |     |   |
| Total     |     |     |     |   |   |   |   |   |   |     |   |

Spielplan für 8 Mannschaften (1 – 8) mit 4 Spielfeldern (A – D)

Jeder gegen jeden



| Spielplan |     |     |     |   |   |   |   |   |   | 9/4 |   |   |
|-----------|-----|-----|-----|---|---|---|---|---|---|-----|---|---|
| A         | B   | C   | D   | 1 | 2 | 3 | 4 | 5 | 6 | 7   | 8 | 9 |
|           |     |     |     |   |   |   |   |   |   |     |   |   |
| 1-8       | 2-7 | 3-6 | 4-5 |   |   |   |   |   |   |     |   |   |
| 9-7       | 1-6 | 2-5 | 3-4 |   |   |   |   |   |   |     |   |   |
| 8-6       | 9-5 | 1-4 | 2-3 |   |   |   |   |   |   |     |   |   |
| 7-5       | 8-4 | 9-3 | 1-2 |   |   |   |   |   |   |     |   |   |
| 6-4       | 7-3 | 8-2 | 9-1 |   |   |   |   |   |   |     |   |   |
| 5-3       | 6-2 | 7-1 | 8-9 |   |   |   |   |   |   |     |   |   |
| 4-2       | 5-1 | 6-9 | 7-8 |   |   |   |   |   |   |     |   |   |
| 3-1       | 4-9 | 5-8 | 6-7 |   |   |   |   |   |   |     |   |   |
| 2-9       | 3-8 | 4-7 | 5-6 |   |   |   |   |   |   |     |   |   |
| Total     |     |     |     |   |   |   |   |   |   |     |   |   |

Spielplan für 9 Mannschaften (1 - 9) mit 4 Spielfeldern (A - D)

Jeder gegen jeden



| Spielplan |         |      |         |          |   |   |   |   |   | 10/5 |   |   |   |    |
|-----------|---------|------|---------|----------|---|---|---|---|---|------|---|---|---|----|
| A         | B       | C    | D       | E        | 1 | 2 | 3 | 4 | 5 | 6    | 7 | 8 | 9 | 10 |
|           | 6 : 3 x |      | 7 : 3 x | 10 : 3 x |   |   |   |   |   |      |   |   |   |    |
|           |         |      |         |          |   |   |   |   |   |      |   |   |   |    |
| 10-1      | 7-4     | 6-5  | 9-2     | 8-3      |   |   |   |   |   |      |   |   |   |    |
| 7-2       | 6-3     | 5-4  | 8-1     | 10-9     |   |   |   |   |   |      |   |   |   |    |
| 4-3       | 5-2     | 10-8 | 7-9     | 6-1      |   |   |   |   |   |      |   |   |   |    |
| 9-4       | 8-5     | 7-6  | 1-3     | 10-2     |   |   |   |   |   |      |   |   |   |    |
| 3-9       | 10-6    | 2-1  | 5-7     | 4-8      |   |   |   |   |   |      |   |   |   |    |
| 10-5      | 2-8     | 1-9  | 4-6     | 3-7      |   |   |   |   |   |      |   |   |   |    |
| 2-6       | 1-7     | 9-8  | 3-5     | 10-4     |   |   |   |   |   |      |   |   |   |    |
| 8-7       | 9-6     | 10-3 | 2-4     | 1-5      |   |   |   |   |   |      |   |   |   |    |
| 6-8       | 4-1     | 3-2  | 10-7    | 5-9      |   |   |   |   |   |      |   |   |   |    |
| Total     |         |      |         |          |   |   |   |   |   |      |   |   |   |    |

Spielplan für 10 Mannschaften (1 – 10) mit 5 Spielfeldern (A – E)

Jeder gegen jeden

| Spielplan |      |      |      |       |   |   |   |   |   |   | 11/5 |   |   |    |    |
|-----------|------|------|------|-------|---|---|---|---|---|---|------|---|---|----|----|
| A         | B    | C    | D    | E     | 1 | 2 | 3 | 4 | 5 | 6 | 7    | 8 | 9 | 10 | 11 |
| 1-10      | 2-9  | 3-8  | 4-7  | 5-6   |   |   |   |   |   |   |      |   |   |    |    |
| 11-9      | 1-8  | 2-7  | 3-6  | 4-5   |   |   |   |   |   |   |      |   |   |    |    |
| 10-8      | 11-7 | 1-6  | 2-5  | 3-4   |   |   |   |   |   |   |      |   |   |    |    |
| 9-7       | 10-6 | 11-5 | 1-4  | 2-3   |   |   |   |   |   |   |      |   |   |    |    |
| 8-6       | 9-5  | 10-4 | 11-3 | 1-2   |   |   |   |   |   |   |      |   |   |    |    |
| 7-5       | 8-4  | 9-3  | 10-2 | 11-1  |   |   |   |   |   |   |      |   |   |    |    |
| 6-4       | 7-3  | 8-2  | 9-1  | 10-11 |   |   |   |   |   |   |      |   |   |    |    |
| 5-3       | 6-2  | 7-1  | 8-11 | 9-10  |   |   |   |   |   |   |      |   |   |    |    |
| 4-2       | 5-1  | 6-11 | 7-10 | 8-9   |   |   |   |   |   |   |      |   |   |    |    |
| 3-1       | 4-11 | 5-10 | 6-9  | 7-8   |   |   |   |   |   |   |      |   |   |    |    |
| 2-11      | 3-10 | 4-9  | 5-8  | 6-7   |   |   |   |   |   |   |      |   |   |    |    |
| Total     |      |      |      |       |   |   |   |   |   |   |      |   |   |    |    |

Spielplan für 11 Mannschaften (1 – 11) mit 5 Spielfeldern (A – E)



Jeder gegen jeden



| A     | B     | C    | D    | E     | F    | Spielplan |   |   |   |   |   |   |   |   |    |    |    |  |  |  |  |  |  |  |  |  |
|-------|-------|------|------|-------|------|-----------|---|---|---|---|---|---|---|---|----|----|----|--|--|--|--|--|--|--|--|--|
|       |       |      |      |       |      | 1         | 2 | 3 | 4 | 5 | 6 | 7 | 8 | 9 | 10 | 11 | 12 |  |  |  |  |  |  |  |  |  |
| 12-1  | 7-6   | 10-3 | 9-4  | 8-5   | 11-2 |           |   |   |   |   |   |   |   |   |    |    |    |  |  |  |  |  |  |  |  |  |
| 12-11 | 10-1  | 7-4  | 5-6  | 9-2   | 8-3  |           |   |   |   |   |   |   |   |   |    |    |    |  |  |  |  |  |  |  |  |  |
| 9-11  | 12-10 | 8-1  | 7-2  | 6-3   | 5-4  |           |   |   |   |   |   |   |   |   |    |    |    |  |  |  |  |  |  |  |  |  |
| 8-10  | 7-11  | 12-9 | 6-1  | 5-2   | 4-3  |           |   |   |   |   |   |   |   |   |    |    |    |  |  |  |  |  |  |  |  |  |
| 7-9   | 3-2   | 5-11 | 12-8 | 4-1   | 6-10 |           |   |   |   |   |   |   |   |   |    |    |    |  |  |  |  |  |  |  |  |  |
| 6-8   | 5-9   | 4-10 | 3-11 | 12-7  | 2-1  |           |   |   |   |   |   |   |   |   |    |    |    |  |  |  |  |  |  |  |  |  |
| 5-7   | 4-8   | 3-9  | 2-10 | 1-11  | 12-6 |           |   |   |   |   |   |   |   |   |    |    |    |  |  |  |  |  |  |  |  |  |
| 4-6   | 12-5  | 2-8  | 1-9  | 11-10 | 3-7  |           |   |   |   |   |   |   |   |   |    |    |    |  |  |  |  |  |  |  |  |  |
| 3-5   | 2-6   | 1-7  | 11-8 | 12-4  | 10-9 |           |   |   |   |   |   |   |   |   |    |    |    |  |  |  |  |  |  |  |  |  |
| 2-4   | 9-8   | 11-6 | 12-3 | 10-7  | 1-5  |           |   |   |   |   |   |   |   |   |    |    |    |  |  |  |  |  |  |  |  |  |
| 1-3   | 11-4  | 12-2 | 10-5 | 9-6   | 8-7  |           |   |   |   |   |   |   |   |   |    |    |    |  |  |  |  |  |  |  |  |  |
| Total |       |      |      |       |      |           |   |   |   |   |   |   |   |   |    |    |    |  |  |  |  |  |  |  |  |  |

Spielplan für 12 Mannschaften (1 – 12) mit 6 Spielfeldern (A – F)



# Losturnier-Spielerblatt

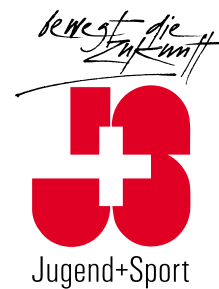

gewonnenes Spiel      2 Punkte  
 unentschiedenes Spiel    1 Punkt  
 verlorenes Spiel        0 Punkte

|      |       |  |
|------|-------|--|
| Name | Rang: | <input style="width: 80%; height: 40px;" type="text"/> |
|------|-------|--|

|   | Resultat | Punkte |
|---|----------|--------|
| 1. Spielrunde   | :        |        |
| 2. Spielrunde   | :        |        |
| 3. Spielrunde   | :        |        |
| 4. Spielrunde   | :        |        |
| 5. Spielrunde   | :        |        |
| 6. Spielrunde   | :        |        |
| 7. Spielrunde   | :        |        |
| 8. Spielrunde   | :        |        |
| 9. Spielrunde   | :        |        |
| 10. Spielrunde  | :        |        |
| Differenz: <input style="width: 100px; height: 20px;" type="text"/> | :        | Total  |

# Davis-Cup-Spielerblatt



| Mannschaft A  | Spielername | Mannschaft B | Spielername | Resultat | Punkte |
|---------------|-------------|--------------|-------------|----------|--------|
| 1. Einzel     |             | 1. Einzel    |             |          |        |
| 2. Einzel     |             | 2. Einzel    |             |          |        |
| 1. Doppel     |             | 1. Doppel    |             |          |        |
| Spielergebnis |             |              |             |          |        |