

Orlando Cylinder Wall Light - 3 Inch

Product Code: OR-CYWL3

H: 39 cm x W: 8 cm x D: 14 cm

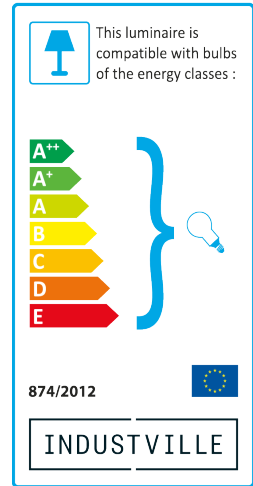
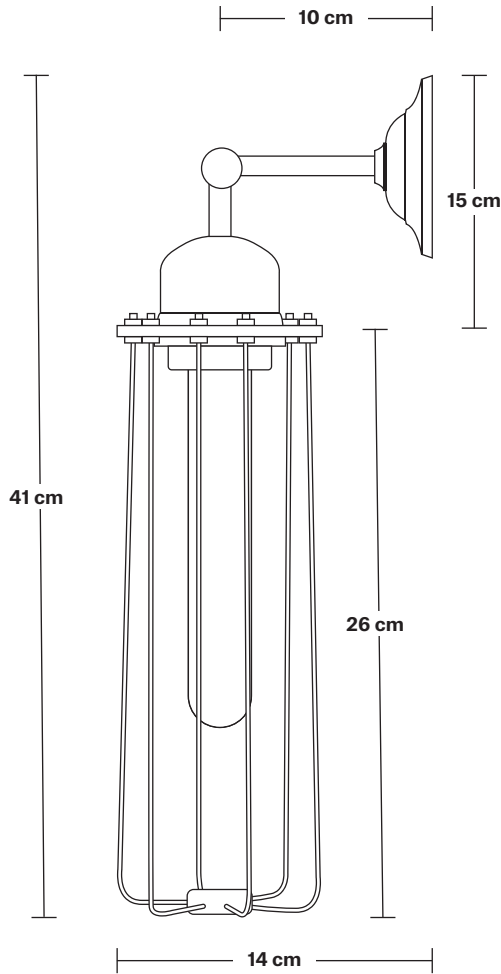

13 cm

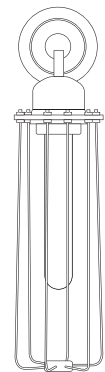

8 cm

SPECIFICATIONS

We meet all UK and EU lighting and safety regulations.

Our products are hand finished to ensure an authentic vintage look and therefore they may vary slightly from those shown in the images.

Bulb required: Standard screw (E27) fitting, max 40W.

Shade weight: 0.5 kg | **Holder weight:** 0.31 kg

Maximum weight: 0.81kg

INFORMATION

Finishes: Brass and Pewter.

Ready to be installed, installation required.

Wall mount screws not included.

Holders available: Brass and Pewter.

Wall mount: Brass and Pewter.

DIMENSIONS

Shade Diameter: 8 cm / 3.1"

Shade Height (no holder): 26 cm / 10.4"

Holder Diameter: 4 cm / 1.6"

Holder Height: 15 cm / 5.9"

Ceiling Rose Diameter: 13 cm / 4.9"

Ceiling Rose Height: 4 cm / 1.6"

INDUSTVILLE

Orlando Cylinder - 3 Inch - Brass

Shade Only

Cylinder - 3 Inch - Brass - Shade Only

CY3-B-SO

Holder Only

Orlando Cylinder Wall Light - Brass - Holder Only

OR-WL-B-HO

Orlando Cylinder Pendant - Brass - Holder Only

OR-P-B-HO

Orlando Cylinder Pendant - 3 Inch - Brass

Orlando Cylinder Pendant - 3 Inch - Brass

OR-CYP3-B

Orlando Cylinder Wall Light - 3 Inch - Brass

Orlando Cylinder Wall Light - 3 Inch - Brass

OR-CYWL3-B
